

	<b>Pictorial index</b>	Search by illustration	
1	<b>For safety and security</b>	Make sure to read through them	
2	<b>Instrument cluster</b>	How to read the gauges and meters, the variety of warning lights and indicators, etc.	
3	<b>Operation of each component</b>	Opening and closing the doors and windows, adjustment before driving, etc.	
4	<b>Driving</b>	Operations and advices which are necessary for driving	
5	<b>Interior features</b>	Usage of the interior features, etc.	
6	<b>Maintenance and care</b>	Caring for your vehicle and maintenance procedures	
7	<b>When trouble arises</b>	What to do in case of malfunction or emergency	
8	<b>Vehicle specifications</b>	Vehicle specifications, customizable features, etc.	
9	<b>For owners</b>	Reporting safety defects for U.S. owners, and seat belt and SRS airbag instructions for Canadian owners	
	<b>Index</b>	Search by symptom	
		Search alphabetically	

For your information.....	8
Reading this manual.....	12
How to search.....	13
Pictorial index .....	14

## 1 For safety and security

### 1-1. For safe use

Before driving .....	26
For safety drive .....	28
Seat belts .....	30
SRS airbags .....	35
Front passenger occupant classification system .....	46
Safety information for children .....	52
Child restraint systems.....	53
Installing child restraints.....	57
Exhaust gas precautions.....	69

### 1-2. Theft deterrent system

Engine immobilizer system.....	70
Alarm.....	72

## 2 Instrument cluster

### 2. Instrument cluster

Warning lights and indicators .....	76
Gauges and meters.....	81
Multi-information display.....	83
Accessory meter.....	89

## 3 Operation of each component

### 3-1. Key information

Keys.....	94
Side doors .....	100

### 3-2. Opening, closing and locking the doors

Smart key system .....	107
Automatic running boards .....	114
Back door.....	117

### 3-3. Adjusting the seats

Front seats.....	122
Rear seats .....	125
Driving position memory .....	135
Head restraints .....	139

### 3-4. Adjusting the steering wheel and mirrors

Steering wheel.....	142
Inside rear view mirror.....	144
Outside rear view mirrors .....	146

### 3-5. Opening, closing the windows and moon roof

Power windows.....	148
Power back window.....	151
Moon roof .....	155

## 4 Driving

### 4-1. Before driving

Driving the vehicle .....	160
Cargo and luggage.....	170
Vehicle load limits .....	175
Trailer towing.....	176
Dinghy towing.....	191

### 4-2. Driving procedures

Engine (ignition) switch (vehicles without a smart key system) .....	192
Engine (ignition) switch (vehicles with a smart key system) .....	195
Automatic transmission .....	200
Turn signal lever.....	203
Parking brake .....	204

### 4-3. Operating the lights and wipers

Headlight switch .....	205
Fog light switch .....	211
Windshield wipers and washer .....	213
Rear window wiper and washer .....	216

### 4-4. Refueling

Opening the fuel tank cap .....	219
------------------------------------	-----

### 4-5. Using the driving support systems

Cruise control .....	222
Intuitive parking assist .....	226
Four-wheel drive system (part-time 4WD models).....	232
Four-wheel drive system (full-time 4WD models)....	236
Active traction control system .....	240
AUTO LSD system .....	242
Rear differential lock system .....	244
Downhill assist control system .....	247
Crawl Control.....	250
Multi-terrain Select.....	253
Driving assist systems .....	260

### 4-6. Driving tips

Winter driving tips .....	269
Off-road precautions.....	273

## 5 Interior features

### 5-1. Using the air conditioning system and defogger

- Manual air conditioning system ..... 280
- Automatic air conditioning system ..... 286
- Seat heaters/  
seat ventilators ..... 293

### 5-2. Using the interior lights

- Interior lights list ..... 295
- Interior lights ..... 296
- Personal lights ..... 296

### 5-3. Using the storage features

- List of storage features ..... 298
- Glove box ..... 299
- Console box ..... 299
- Cup holders ..... 300
- Auxiliary box ..... 302
- Coin holder/  
tissue pocket/  
pen holder ..... 303
- Bottle holders ..... 304
- Luggage compartment  
features ..... 305

### 5-4. Other interior features

- Other interior features ..... 310
- Sun visors ..... 310
- Vanity mirrors ..... 310
- Clock ..... 311
- Outside temperature  
display ..... 312
- Power outlets  
(120 V AC) ..... 314
- Power outlets ..... 319
- Armrest ..... 321
- Assist grips ..... 322
- Garage door opener ..... 323
- Safety Connect ..... 330
- Compass ..... 335



## 6 Maintenance and care

### 6-1. Maintenance and care

- Cleaning and protecting the vehicle exterior ..... 342
- Cleaning and protecting the vehicle interior ..... 344

### 6-2. Maintenance

- Maintenance requirements ..... 347
- General maintenance ..... 349
- Emission inspection and maintenance (I/M) programs ..... 352

### 6-3. Do-it-yourself maintenance

- Do-it-yourself service precautions ..... 353
- Hood ..... 356
- Engine compartment ..... 357
- Tires ..... 372
- Tire inflation pressure ..... 377
- Wheels ..... 380
- Air conditioning filter ..... 383
- Wireless remote control/electronic key battery ..... 385
- Checking and replacing fuses ..... 388
- Light bulbs ..... 391

## 7 When trouble arises

### 7-1. Essential information

- Emergency flashers ..... 408
- If your vehicle has to be stopped in an emergency ..... 409

### 7-2. Steps to take in an emergency

- If your vehicle needs to be towed ..... 411
- If you think something is wrong ..... 416
- Fuel pump shut off system ..... 417
- If a warning light turns on or a warning buzzer sounds ..... 418
- If a warning message or indicator is displayed ..... 426
- If you have a flat tire ..... 433
- If the engine will not start ..... 446
- If the shift lever cannot be shifted from P ..... 448
- If you cannot operate back door opener ..... 449
- If the electronic key does not operate properly ..... 450
- If the vehicle battery is discharged ..... 452
- If your vehicle overheats ..... 455
- If the vehicle becomes stuck ..... 458

**8 Vehicle specifications****8-1. Specifications**

Maintenance data (fuel, oil level, etc.) .....	460
Fuel information .....	470
Tire information .....	473

**8-2. Customization**

Customizable features .....	485
-----------------------------	-----

**8-3. Items to initialize**

Items to initialize.....	491
--------------------------	-----

**9 For owners**

Reporting safety defects for U.S. owners.....	494
--	-----

Seat belt instructions for Canadian owners (in French) .....	495
--	-----

SRS airbag instructions for Canadian owners (in French).....	497
--	-----

**Index**

What to do if... (Troubleshooting).....	508
Alphabetical index.....	514

امداد خودرو فارما  
تلفن شبانه روزی: ۰۸۵ ۸۸۶۲۰۰۰۰  
FarmaSOS.com

For vehicles with a audio/navigation system, refer to the “Navigation System Owner’s Manual” for information regarding the audio/navigation system.

# امداد خودرو فارما

تلفن شبانه روزی: ۰۲۱-۸۸۸۶۲۰۸۵

[FarmaSOS.com](http://FarmaSOS.com)

1

2

3

4

5

6

7

8

9

## For your information

### Main Owner's Manual

Please note that this manual applies to all models and explains all equipment, including options. Therefore, you may find some explanations for equipment not installed on your vehicle.

All specifications provided in this manual are current at the time of printing. However, because of the Toyota policy of continual product improvement, we reserve the right to make changes at any time without notice.

Depending on specifications, the vehicle shown in the illustrations may differ from your vehicle in terms of color and equipment.

### Noise from under vehicle after turning off the engine

Approximately five hours after the engine is turned off, you may hear sound coming from under the vehicle for several minutes. This is the sound of a fuel evaporation leakage check and, it does not indicate a malfunction.

### Accessories, spare parts and modification of your Toyota

A wide variety of non-genuine spare parts and accessories for Toyota vehicles are currently available in the market. You should know that Toyota does not warrant these products and is not responsible for their performance, repair, or replacement, or for any damage they may cause to, or adverse effect they may have on, your Toyota vehicle.

This vehicle should not be modified with non-genuine Toyota products. Modification with non-genuine Toyota products could affect its performance, safety or durability, and may even violate governmental regulations. In addition, damage or performance problems resulting from the modification may not be covered under warranty.

### Installation of a mobile two-way radio system

The installation of a mobile two-way radio system in your vehicle could affect electronic systems such as:

- Multiport fuel injection system/sequential multiport fuel injection system
- Cruise control system
- Anti-lock brake system
- SRS airbag system
- Seat belt pretensioner system

Be sure to check with your Toyota dealer for precautionary measures or special instructions regarding installation of a mobile two-way radio system.

### Vehicle data recordings

Your Toyota is equipped with several sophisticated computers that will record certain data, such as:

- Engine speed
- Accelerator status
- Brake status
- Vehicle speed
- Shift position

The recorded data varies according to the vehicle grade level and options with which it is equipped. Furthermore, these computers do not record conversations, sounds or pictures.

#### ● Data usage

Toyota may use the data recorded in these computers to diagnose malfunctions, conduct research and development, and improve quality.

Toyota will not disclose the recorded data to a third party except:

- With the consent of the vehicle owner or with the consent of the lessee if the vehicle is leased
  - In response to an official request by the police, a court of law or a government agency
  - For use by Toyota in a law suit
  - For research purposes where the data is not tied to a specific vehicle or vehicle owner
- #### ● Usage of data collected through Safety Connect (U.S. mainland only)
- If your Toyota has Safety Connect and if you have subscribed to those services, please refer to the Safety Connect Telematics Subscription Service Agreement for information on data collected and its usage.

---

### Event data recorder

This vehicle is equipped with an event data recorder (EDR). The main purpose of an EDR is to record, in certain crash or near crash-like situations, such as an air bag deployment or hitting a road obstacle, data that will assist in understanding how a vehicle's systems performed. The EDR is designed to record data related to vehicle dynamics and safety systems for a short period of time, typically 30 seconds or less.

The EDR in this vehicle is designed to record such data as:

- How various systems in your vehicle were operating;
- Whether or not the driver and passenger safety belts were buckled/fastened;
- How far (if at all) the driver was depressing the accelerator and/or brake pedal; and,
- How fast the vehicle was traveling.

These data can help provide a better understanding of the circumstances in which crashes and injuries occur.

NOTE: EDR data are recorded by your vehicle only if a nontrivial crash situation occurs; no data are recorded by the EDR under normal driving conditions and no personal data (e.g., name, gender, age, and crash location) are recorded. However, other parties, such as law enforcement, could combine the EDR data with the type of personally identifying data routinely acquired during a crash investigation.

To read data recorded by an EDR, special equipment is required, and access to the vehicle or the EDR is needed. In addition to the vehicle manufacturer, other parties, such as law enforcement, that have the special equipment, can read the information if they have access to the vehicle or the EDR.

● Disclosure of the EDR data

Toyota will not disclose the data recorded in an EDR to a third party except when:

- An agreement from the vehicle's owner (or the lessee for a leased vehicle) is obtained
- In response to an official request by the police, a court of law or a government agency
- For use by Toyota in a lawsuit

However, if necessary, Toyota may:

- Use the data for research on vehicle safety performance
- Disclose the data to a third party for research purposes without disclosing information about the specific vehicle or vehicle owner

### Scraping of your Toyota

The SRS airbag and seat belt pretensioner devices in your Toyota contain explosive chemicals. If the vehicle is scrapped with the airbags and seat belt pretensioners left as they are, this may cause an accident such as fire. Be sure to have the systems of the SRS airbag and seat belt pretensioner removed and disposed of by a qualified service shop or by your Toyota dealer before you scrap your vehicle.

### Perchlorate Material

Special handling may apply, See [www.dtsc.ca.gov/hazardouswaste/perchlorate](http://www.dtsc.ca.gov/hazardouswaste/perchlorate).

Your vehicle has components that may contain perchlorate. These components may include airbag, seat belt pretensioners, and wireless remote control batteries.

#### CAUTION

##### ■ General precautions while driving

**Driving under the influence:** Never drive your vehicle when under the influence of alcohol or drugs that have impaired your ability to operate your vehicle. Alcohol and certain drugs delay reaction time, impair judgment and reduce coordination, which could lead to an accident that could result in death or serious injury.

**Defensive driving:** Always drive defensively. Anticipate mistakes that other drivers or pedestrians might make and be ready to avoid accidents.

**Driver distraction:** Always give your full attention to driving. Anything that distracts the driver, such as adjusting controls, talking on a cellular phone or reading can result in a collision with resulting death or serious injury to you, your occupants or others.

##### ■ General precaution regarding children's safety

Never leave children unattended in the vehicle, and never allow children to have or use the key.

Children may be able to start the vehicle or shift the vehicle into neutral. There is also a danger that children may injure themselves by playing with the windows, the moon roof, or other features of the vehicle. In addition, heat build-up or extremely cold temperatures inside the vehicle can be fatal to children.

## Reading this manual



### CAUTION:

Explains something that, if not obeyed, could cause death or serious injury to people.



### NOTICE:

Explains something that, if not obeyed, could cause damage to or a malfunction in the vehicle or its equipment.

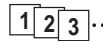

Indicates operating or working procedures. Follow the steps in numerical order.



Indicates the action (pushing, turning, etc.) used to operate switches and other devices.



Indicates the outcome of an operation (e.g. a lid opens).

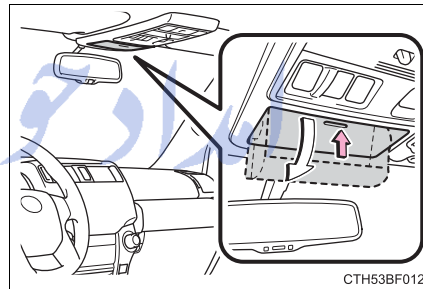

Indicates the component or position being explained.



Means “Do not”, “Do not do this”, or “Do not let this happen”.

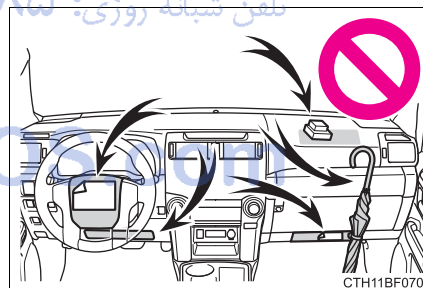



## How to search

### ■ Searching by name

- Alphabetical index.....P. 514

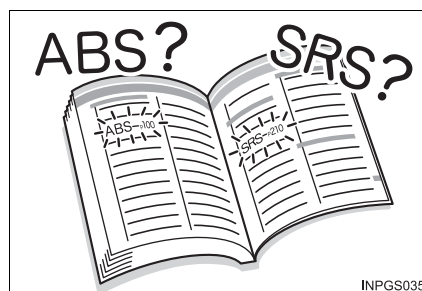

### ■ Searching by installation position

- Pictorial index.....P. 14

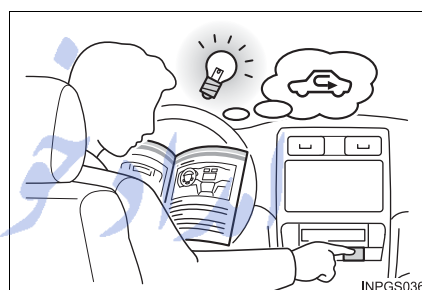

### ■ Searching by symptom or sound

- What to do if...  
(Troubleshooting).....P. 508



### ■ Searching by title

- Table of contents.....P. 2

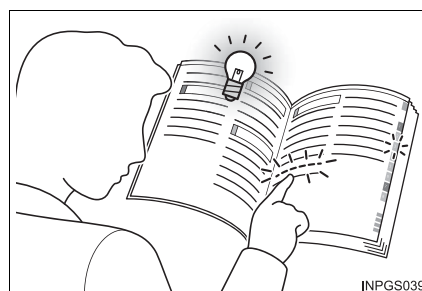

## Pictorial index

### Exterior

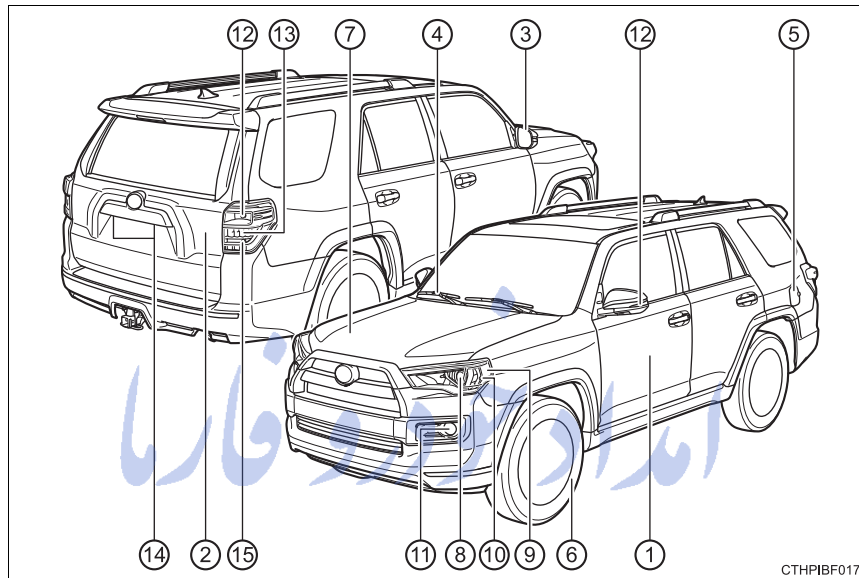

CTHPIBF017

- ① **Side doors** ..... **P. 100**
  - Locking/unlocking ..... P. 100
  - Opening/closing the door glasses ..... P. 148
  - Locking/unlocking by using the mechanical key\* ..... P. 450
  - Warning lights/warning messages ..... P. 420, 427
- ② **Back door** ..... **P. 117**
  - Locking/unlocking ..... P. 117
  - Opening/closing the door glasses ..... P. 151
  - Warning lights/warning messages ..... P. 420, 426
- ③ **Outside rear view mirrors** ..... **P. 146**
  - Adjusting the mirror angle ..... P. 146
  - Folding the mirrors ..... P. 146
  - Defogging the mirrors ..... P. 282, 288
- ④ **Windshield wipers** ..... **P. 213**
  - Precautions against winter season ..... P. 269
- ⑤ **Fuel filler door** ..... **P. 219**
  - Refueling method ..... P. 219
  - Fuel type/fuel tank capacity ..... P. 462

- ⑥ **Tires** . . . . . **P. 372**
  - Tire size/inflation pressure . . . . . P. 468
  - Winter tires/tire chain . . . . . P. 269
  - Checking/rotation/tire pressure warning system . . . . . P. 372
  - Coping with flat tires . . . . . P. 433
- ⑦ **Hood** . . . . . **P. 356**
  - Opening . . . . . P. 356
  - Engine oil . . . . . P. 463
  - Coping with overheat . . . . . P. 455

**Light bulbs of the exterior lights for driving**  
 (Replacing method: P. 391, Wattages: P. 469)

- ⑧ **Headlights/daytime running lights** . . . . . **P. 205**
- ⑨ **Front side marker lights** . . . . . **P. 205**
- ⑩ **Front turn signal/parking lights** . . . . . **P. 205**
- ⑪ **Fog lights** . . . . . **P. 211**
- ⑫ **Turn signal lights** . . . . . **P. 203**
- ⑬ **Stop/tail lights/rear side marker lights** . . . . . **P. 205**
- ⑭ **License plate lights** . . . . . **P. 205**
- ⑮ **Back-up lights**
  - Shifting the shift lever to R. . . . . P. 200

FarmaSOS.com

\*: Vehicles with a smart key system

## ■ Instrument panel

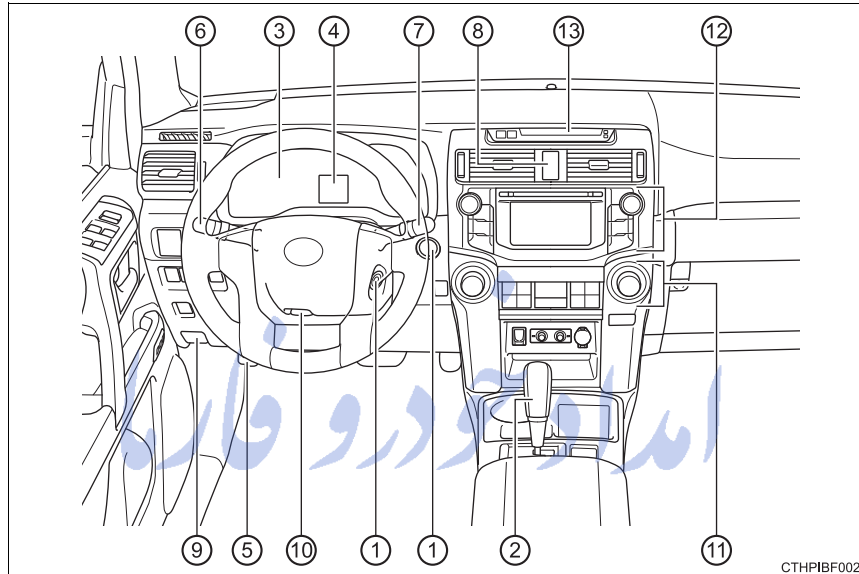

- |   |  |                    |
|---|--|--------------------|
| ① | <b>Engine switch</b> . . . . .                   | <b>P. 192, 195</b> |
|   | Starting the engine/changing the modes . . . . . | P. 192, 195        |
|   | Emergency stop of the engine . . . . .           | P. 409             |
|   | When the engine will not start . . . . .         | P. 446             |
|   | Warning messages . . . . .                       | P. 429             |
| ② | <b>Shift lever</b> . . . . .                     | <b>P. 200</b>      |
|   | Changing the shift position . . . . .            | P. 200             |
|   | Precautions against towing . . . . .             | P. 411             |
|   | When the shift lever does not move . . . . .     | P. 448             |
| ③ | <b>Meters</b> . . . . .                          | <b>P. 81</b>       |
|   | Reading the meters . . . . .                     | P. 81              |
|   | Warning lights/indicator lights . . . . .        | P. 76              |
|   | When the warning lights come on . . . . .        | P. 418             |

④	<b>Multi-information display</b> . . . . .	<b>P. 83</b>
	Display . . . . .	P. 83
	When the warning messages are displayed . . . . .	P. 426
⑤	<b>Parking brake</b> . . . . .	<b>P. 204</b>
	Applying/releasing . . . . .	P. 204
	Precautions against winter season . . . . .	P. 270
	Warning buzzer/message . . . . .	P. 426
⑥	<b>Turn signal lever</b> . . . . .	<b>P. 203</b>
	Headlight switch . . . . .	P. 205
	Headlights/parking lights/tail lights/daytime running lights . . . . .	P. 205
	Fog lights . . . . .	P. 211
⑦	<b>Windshield wiper and washer switch</b> . . . . .	<b>P. 213</b>
	Usage . . . . .	P. 213
	Adding washer fluid . . . . .	P. 370
⑧	<b>Emergency flasher switch</b> . . . . .	<b>P. 408</b>
⑨	<b>Hood lock release lever</b> . . . . .	<b>P. 356</b>
⑩	<b>Tilt and telescopic steering lock release lever</b> . . . . .	<b>P. 142</b>
⑪	<b>Air conditioning system</b> . . . . .	<b>P. 280, 286</b>
	Usage . . . . .	P. 280, 286
	Rear window defogger . . . . .	P. 282, 288
⑫	<b>Audio/Navigation system</b> *1	
⑬	<b>Accessory meter</b> *2 . . . . .	<b>P. 89</b>
	Clock . . . . .	P. 311

FarmaSOS.com

\*1: Refer to "Navigation System Owner's Manual".  
\*2: If equipped

■ Switches

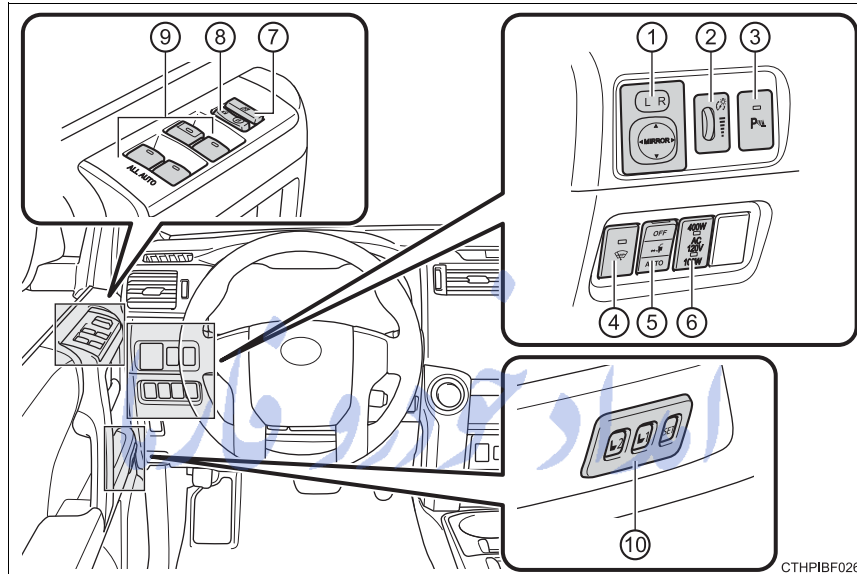

CTHPIBF026

- ① Outside rear view mirror switches ..... P. 146
- ② Instrument panel light control dial ..... P. 82
- ③ Intuitive parking assist switch \*1 ..... P. 226
- ④ Windshield wiper de-icer switch \*1 ..... P. 282, 288
- ⑤ Automatic running boards switch \*1 ..... P. 114
- ⑥ Power outlet main switch \*1 ..... P. 314
- ⑦ Window lock switch ..... P. 148
- ⑧ Door lock switches ..... P. 102
- ⑨ Power window switches ..... P. 148
- ⑩ Driving position memory switches \*1 ..... P. 135

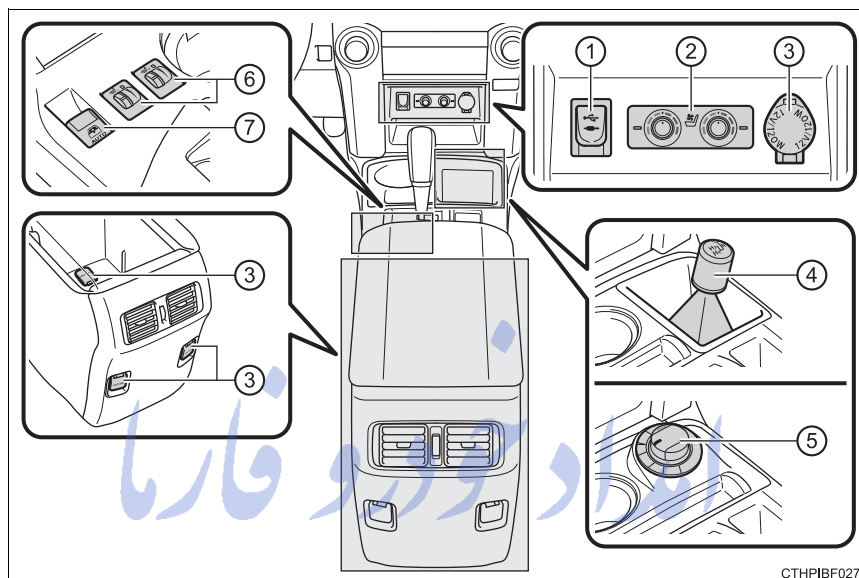

CTHPIBF027

- ① AUX port\*<sup>2</sup>/USB port\*<sup>2</sup>
- ② Seat heater/ventilator switches\*<sup>1</sup> ..... P. 293
- ③ Power outlets ..... P. 319
- ④ Front-wheel drive control lever\*<sup>1</sup> ..... P. 232
- ⑤ Front-wheel drive control switch\*<sup>1</sup> ..... P. 232
- Four-wheel drive control switch\*<sup>1</sup> ..... P. 236
- ⑥ Seat heater switches\*<sup>1</sup> ..... P. 293
- ⑦ Power back window switch ..... P. 151

\*<sup>1</sup>: If equipped

\*<sup>2</sup>: Refer to "Navigation System Owner's Manual".

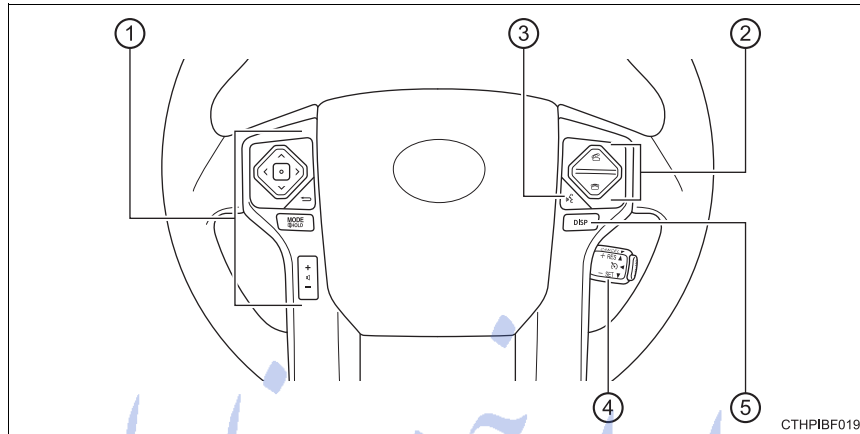

- ① Audio remote control switches\*
- ② Telephone switches\*
- ③ Talk switch\*
- ④ Cruise control switch ..... P. 222
- ⑤ "DISP" switch..... P. 84

تلفن شبانه روزی: ۰۲۱-۸۸۶۲۰۸۵

FarmaSOS.com



## Interior

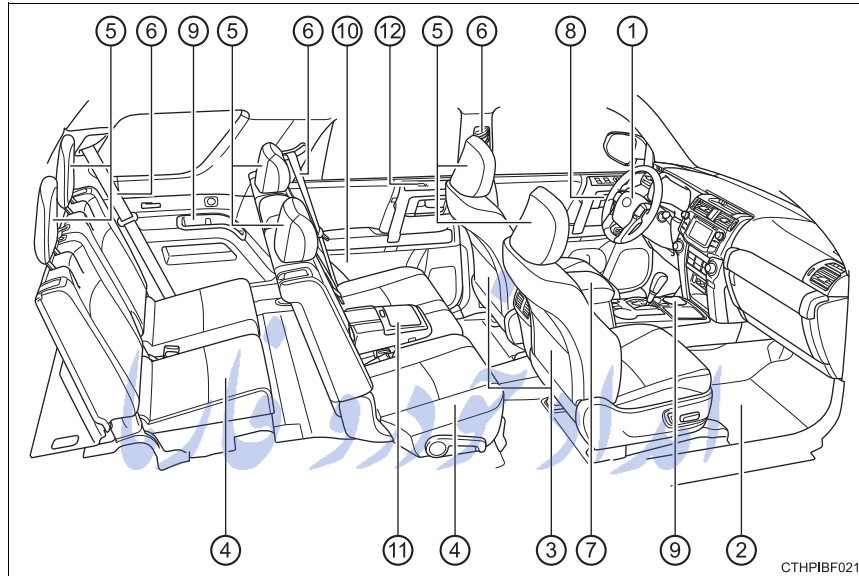

- |                             |       |             |
|-----------------------------|-------|-------------|
| ① SRS airbags               | ..... | P. 35       |
| ② Floor mat                 | ..... | P. 26       |
| ③ Front seats               | ..... | P. 122      |
| ④ Rear seats                | ..... | P. 125      |
| ⑤ Head restraints           | ..... | P. 139      |
| ⑥ Seat belts                | ..... | P. 30       |
| ⑦ Console box/tissue pocket | ..... | P. 299, 303 |
| ⑧ Inside lock buttons       | ..... | P. 102      |
| ⑨ Cup holders               | ..... | P. 300      |
| ⑩ Bottle holders            | ..... | P. 304      |
| ⑪ Armrest/cup holders       | ..... | P. 300, 321 |
| ⑫ Power window switches     | ..... | P. 148      |

\*: Refer to "Navigation System Owner's Manual".

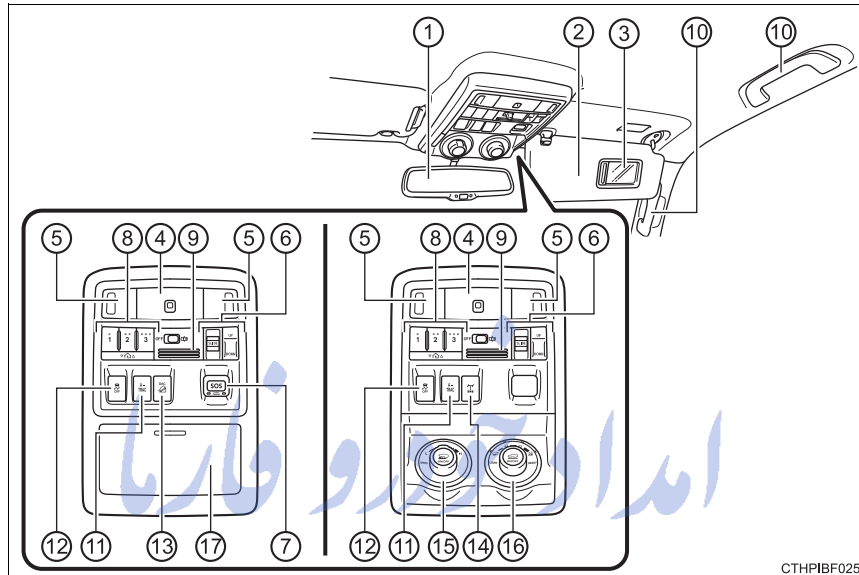

CTHPIBF025

- ① Inside rear view mirror ..... P. 144  
 ② Sun visors ..... P. 310  
 ③ Vanity mirrors ..... P. 310  
 ④ Interior light\*2 ..... P. 296  
 ⑤ Personal lights ..... P. 296  
 ⑥ Moon roof switches\*1 ..... P. 155  
 ⑦ "SOS" button\*1 ..... P. 330  
 ⑧ Garage door opener switches\*1 ..... P. 323  
 ⑨ Microphone\*3  
 ⑩ Assist grips ..... P. 322  
 ⑪ Active traction control switch\*1 ..... P. 240  
 ⑫ VSC off switch ..... P. 262  
 ⑬ DAC switch\*1 ..... P. 247  
 ⑭ Rear differential lock switch\*1 ..... P. 244  
 ⑮ Crawl Control switch\*1 ..... P. 250  
 ⑯ Multi-terrain Select switch\*1 ..... P. 253  
 ⑰ Auxiliary box\*1 ..... P. 302

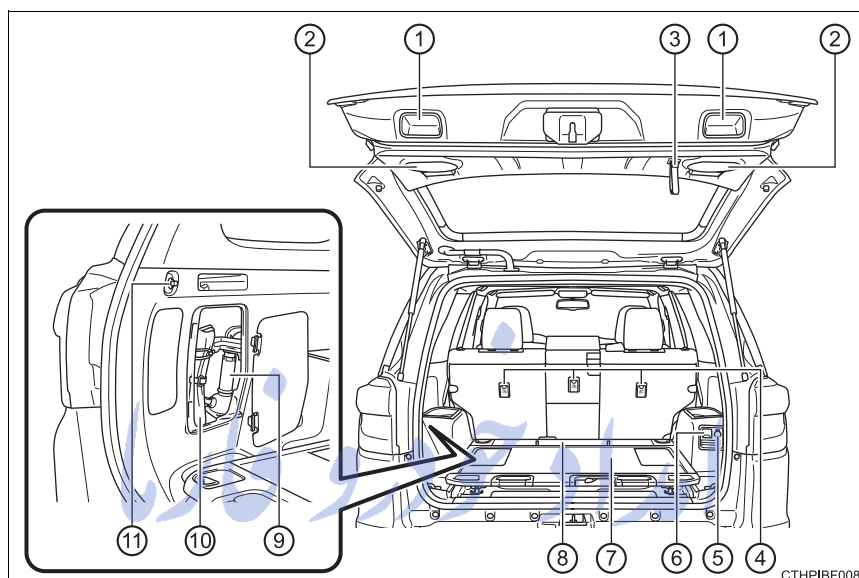

- ① Back door handles..... P. 118
- ② Luggage compartment lights ..... P. 119
- ③ Back door strap ..... P. 118
- ④ Child restraint anchor brackets ..... P. 57
- ⑤ Power outlets ..... P. 319
- ⑥ Power outlets(120 V AC)\*1 ..... P. 314
- ⑦ Slide deck\*1 ..... P. 308
- ⑧ Storage compartment\*1 ..... P. 307
- ⑨ Jack..... P. 433
- ⑩ Tool bag ..... P. 433
- ⑪ Cargo net hooks/Grocery bag hooks..... P. 306, 308

\*1: If equipped

\*2: The illustration shows the front, but they are also equipped in the rear.

\*3: Refer to "Navigation System Owner's Manual".

امداد خودرو فارما

تلفن شبانه روزی: ۰۲۱-۸۸۸۶۲۰۸۵

**FarmaSOS.com**

**For safety and security****1****1-1. For safe use**

Before driving.....	26
For safety drive .....	28
Seat belts .....	30
SRS airbags.....	35
Front passenger occupant classification system .....	46
Safety information for ♦ children .....	52
Child restraint systems.....	53
Installing child restraints.....	57
Exhaust gas precautions.....	69

**1-2. Theft deterrent system**

Engine immobilizer system .....	70
Alarm.....	72

تلفن شبانه روزی: ۰۲۱-۸۸۸۶۲۰۸۵

**FarmaSOS.com**

## Before driving

### Floor mat

Use only floor mats designed specifically for vehicles of the same model and model year as your vehicle. Fix them securely in place onto the carpet.

- 1 Insert the retaining hooks (clips) into the floor mat eyelets.

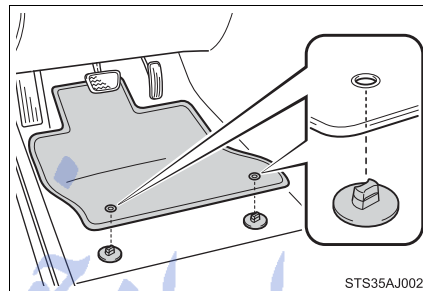

- 2 Turn the upper knob of each retaining hook (clip) to secure the floor mats in place.

\*: Always align the  $\triangle$  marks.

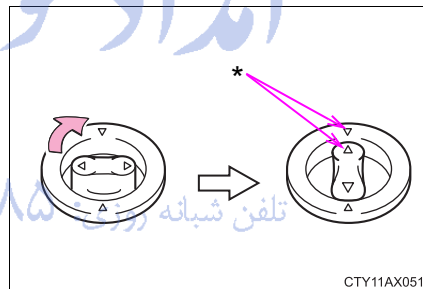

The shape of the retaining hooks (clips) may differ from that shown in the illustration.

**⚠ CAUTION**

Observe the following precautions.

Failure to do so may cause the driver's floor mat to slip, possibly interfering with the pedals while driving. An unexpectedly high speed may result or it may become difficult to stop the vehicle, leading to an accident, or leading to death or a serious injury.

**■ When installing the driver's floor mat**

- Do not use floor mats designed for other models or different model year vehicles, even if they are Toyota Genuine floor mats.
- Only use floor mats designed for the driver's seat.
- Always install the floor mat securely using the retaining hooks (clips) provided.
- Do not use two or more floor mats on top of each other.
- Do not place the floor mat bottom-side up or upside-down.

**■ Before driving**

- Check that the floor mat is securely fixed in the correct place with all the provided retaining hooks (clips). Be especially careful to perform this check after cleaning the floor.
- With the engine stopped and the shift lever in P, fully depress each pedal to the floor to make sure it does not interfere with the floor mat.

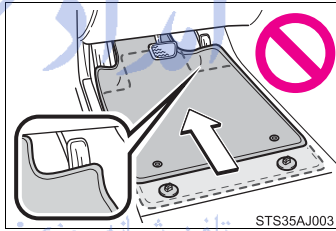

FarmaSOS.com

## For safety drive

**For safe driving, adjust the seat and mirror to an appropriate position before driving.**

### Correct driving posture

- ① Adjust the angle of the seat-back so that you are sitting straight up and so that you do not have to lean forward to steer. (→P. 122)
- ② Adjust the seat so that you can depress the pedals fully and so that your arms bend slightly at the elbow when gripping the steering wheel. (→P. 122)
- ③ Adjust the tilt and telescopic positions of the steering wheel downward so the airbag is facing your chest. (→P. 142)
- ④ Lock the head restraint in place with the center of the head restraint closest to the top of your ears. (→P. 139)
- ⑤ Wear the seat belt correctly. (→P. 30)

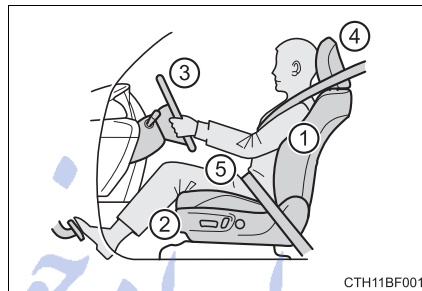

### Correct use of the seat belts

Make sure that all occupants are wearing their seat belts before driving the vehicle. (→P. 30)

Use a child restraint system appropriate for the child until the child becomes large enough to properly wear the vehicle's seat belt. (→P. 53)



### Adjusting the mirrors

Make sure that you can see backward clearly by adjusting the inside and outside rear view mirrors properly. (→P. 144, 146)

#### CAUTION

Observe the following precautions.

Failure to do so may result in death or serious injury.

- Do not adjust the position of the driver's seat while driving.  
Doing so could cause the driver to lose control of the vehicle.
- Do not place a cushion between the driver or passenger and the seatback.  
A cushion may prevent correct posture from being achieved, and reduce the effectiveness of the seat belt and head restraint.
- Do not place anything under the front seats.  
Objects placed under the front seats may become jammed in the seat tracks and stop the seat from locking in place. This may lead to an accident and the adjustment mechanism may also be damaged.
- When driving over long distances, take regular breaks before you start to feel tired.  
Also, if you feel tired or sleepy while driving, do not force yourself to continue driving and take a break immediately.

تلفن شبانه روزی: ۰۲۱-۸۸۸۶۲۰۸۵

FarmaSOS.com

## Seat belts

**Make sure that all occupants are wearing their seat belts before driving the vehicle.**

### Correct use of the seat belts

- Extend the shoulder belt so that it comes fully over the shoulder, but does not come into contact with the neck or slide off the shoulder.
- Position the lap belt as low as possible over the hips.
- Adjust the position of the seat-back. Sit up straight and well back in the seat.
- Do not twist the seat belt.

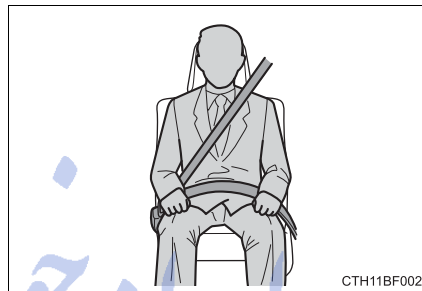

### Fastening and releasing the seat belt

- ① To fasten the seat belt, push the plate into the buckle until a click sound is heard.
- ② To release the seat belt, press the release button.

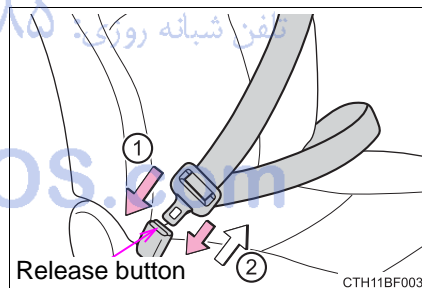

### Adjusting the seat belt shoulder anchor height (front seats)

- ① Push the seat belt shoulder anchor down while pressing the release button.
- ② Push the seat belt shoulder anchor up.

Move the height adjuster up and down as needed until you hear a click.

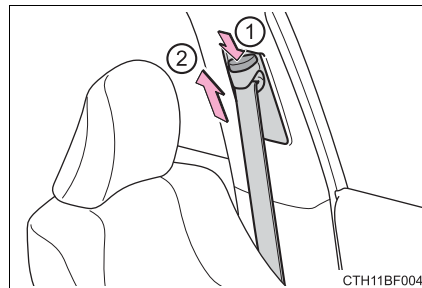

### Seat belt pretensioners (front seats)

The pretensioners help the seat belts to quickly restrain the occupants by retracting the seat belts when the vehicle is subjected to certain types of severe frontal and side collision or a vehicle rollover.

The pretensioners do not activate in the event of a minor frontal impact, a minor side impact, a rear impact or a vehicle rollover.

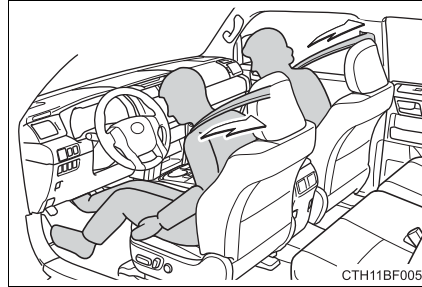

#### ■ Emergency locking retractor (ELR)

The retractor will lock the belt during a sudden stop or on impact. It may also lock if you lean forward too quickly. A slow, easy motion will allow the belt to extend so that you can move around fully.

#### ■ Automatic locking retractor (ALR)

When a passenger's shoulder belt is completely extended and then retracted even slightly, the belt is locked in that position and cannot be extended. This feature is used to hold the child restraint system (CRS) firmly. To free the belt again, fully retract the belt and then pull the belt out once more. (→P. 57)

#### ■ Child seat belt usage

The seat belts of your vehicle were principally designed for persons of adult size.

- Use a child restraint system appropriate for the child, until the child becomes large enough to properly wear the vehicle's seat belt. (→P. 53)
- When the child becomes large enough to properly wear the vehicle's seat belt, follow the instructions regarding seat belt usage. (→P. 30)

#### ■ Replacing the belt after the pretensioner has been activated

If the vehicle is involved in multiple collisions, the pretensioner will activate for the first collision, but will not activate for the second or subsequent collisions.

#### ■ Seat belt extender

If your seat belts cannot be fastened securely because they are not long enough, a personalized seat belt extender is available from your Toyota dealer free of charge.

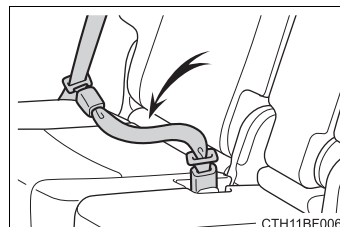

**⚠ CAUTION**

Observe the following precautions to reduce the risk of injury in the event of sudden braking, sudden swerving or an accident. Failure to do so may cause death or serious injury.

■ **Wearing a seat belt**

- Ensure that all passengers wear a seat belt.
- Always wear a seat belt properly.
- Each seat belt should be used by one person only. Do not use a seat belt for more than one person at once, including children.
- Toyota recommends that children be seated in the rear seat and always use a seat belt and/or an appropriate child restraint system.
- To achieve a proper seating position, do not recline the seat more than necessary. The seat belt is most effective when the occupants are sitting up straight and well back in the seats.
- Do not wear the shoulder belt under your arm.
- Always wear your seat belt low and snug across your hips.

■ **Pregnant women**

Obtain medical advice and wear the seat belt in the proper way. (→P. 30)

Women who are pregnant should position the lap belt as low as possible over the hips in the same manner as other occupants, extending the shoulder belt completely over the shoulder and avoiding belt contact with the rounding of the abdominal area.

If the seat belt is not worn properly, not only the pregnant woman, but also the fetus could suffer death or serious injury as a result of sudden braking or a collision.

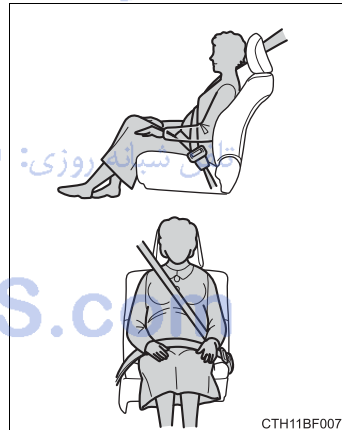

 CAUTION**■ People suffering illness**

Obtain medical advice and wear the seat belt in the proper way. (→P. 30)

**■ When children are in the vehicle**

Do not allow children to play with the seat belt. If the seat belt becomes twisted around a child's neck, it may lead to choking or other serious injuries that could result in death.

If this occurs and the buckle cannot be unfastened, scissors should be used to cut the belt.

**■ Seat belt pretensioners**

● Do not place anything, such as a cushion, on the front passenger's seat. Doing so will disperse the passenger's weight, which prevents the sensor from detecting the passenger's weight properly. As a result, the seat belt pretensioner for the front passenger's seat may not activate in the event of a collision.

● If the pretensioner has activated, the SRS warning light will come on. In that case, the seat belt cannot be used again and must be replaced at your Toyota dealer.

**■ Adjustable shoulder anchor**

Always make sure the shoulder belt is positioned across the center of your shoulder. The belt should be kept away from your neck, but not falling off your shoulder. Failure to do so could reduce the amount of protection in an accident and cause death or serious injuries in the event of a sudden stop, sudden swerve or accident. (→P. 30)

FarmaSOS.com

 CAUTION**■ Seat belt damage and wear**

- Do not damage the seat belts by allowing the belt, plate, or buckle to be jammed in the door.
- Inspect the seat belt system periodically. Check for cuts, fraying, and loose parts. Do not use a damaged seat belt until it is replaced. Damaged seat belts cannot protect an occupant from death or serious injury.
- Ensure that the belt and plate are locked and the belt is not twisted. If the seat belt does not function correctly, immediately contact your Toyota dealer.
- Replace the seat assembly, including the belts, if your vehicle has been involved in a serious accident, even if there is no obvious damage.
- Do not attempt to install, remove, modify, disassemble or dispose of the seat belts. Have any necessary repairs carried out by your Toyota dealer. Inappropriate handling may lead to incorrect operation.

**■ Using a seat belt extender**

- Do not wear the seat belt extender if you can fasten the seat belt without the extender.
- Do not use the seat belt extender when installing a child restraint system because the belt will not securely hold the child restraint system, increasing the risk of death or serious injury in the event of an accident.
- The personalized extender may not be safe on another vehicle, when used by another person, or at a different seating position other than the one originally intended.

 NOTICE**■ When using a seat belt extender**

When releasing the seat belt, press on the buckle release button on the extender, not on the seat belt.  
This helps prevent damage to the vehicle interior and the extender itself.

## SRS airbags

The SRS airbags inflate when the vehicle is subjected to certain types of severe impacts that may cause significant injury to the occupants. They work together with the seat belts to help reduce the risk of death or serious injury.

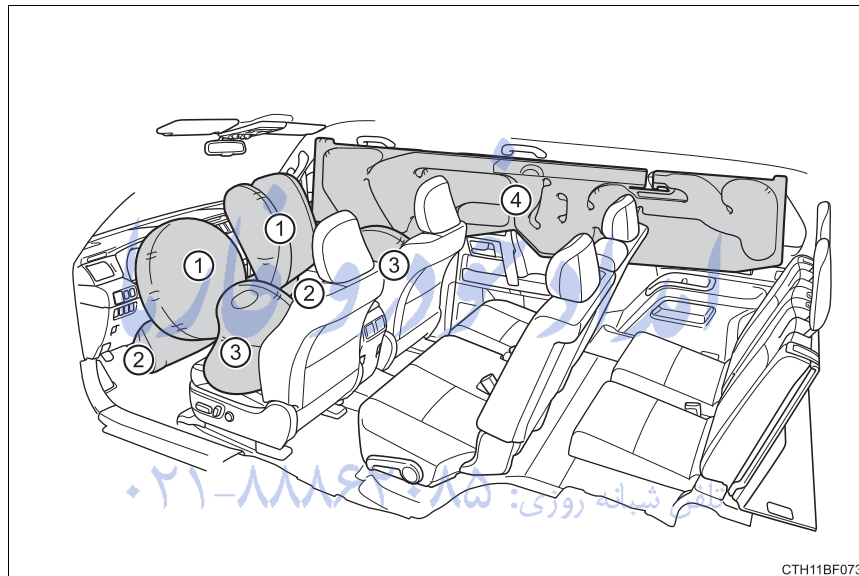

### ◆ SRS front airbags

- ① SRS driver airbag/front passenger airbag  
Can help protect the head and chest of the driver and front passenger from impact with interior components
- ② SRS knee airbags  
Can help provide driver and front passenger protection

### ◆ SRS side and curtain shield airbags

- ③ SRS side airbags  
Can help protect the torso of the front seat occupants
- ④ SRS curtain shield airbags
  - Can help protect primarily the head of occupants in the outer seats
  - Can prevent the occupants from being thrown from the vehicle in the event of vehicle rollover

### SRS airbag system components

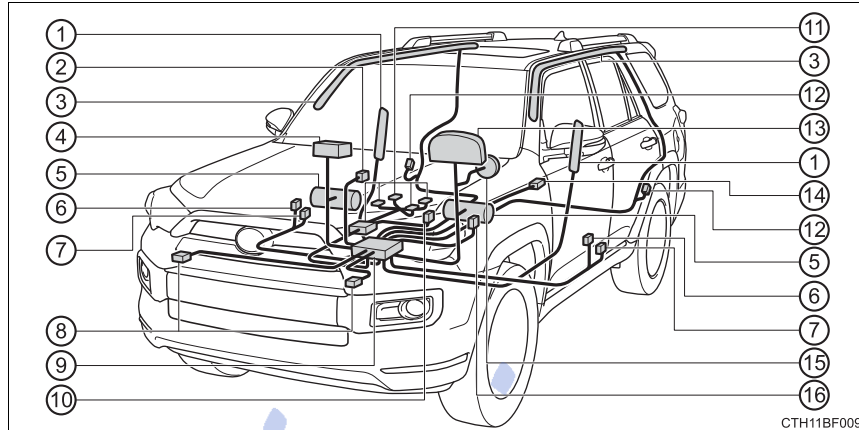

- |   |  |
|---|--|
| ① Side airbags                                    | ⑪ Front passenger occupant classification system (ECU and sensors) |
| ② “AIR BAG ON” and “AIR BAG OFF” indicator lights | ⑫ Side impact sensors (rear)                                       |
| ③ Curtain shield airbags                          | ⑬ SRS warning light  |
| ④ Front passenger airbag                          | ⑭ Safing sensor (rear)   |
| ⑤ Knee airbags                                    | ⑮ Driver airbag  |
| ⑥ Side impact sensors (front door)                | ⑯ Driver's seat belt buckle switch                                 |
| ⑦ Seat belt pretensioners and force limiters      |  |
| ⑧ Front impact sensors                            |  |
| ⑨ Airbag sensor assembly                          |  |
| ⑩ Front passenger's seat belt buckle switch       |  |



Your vehicle is equipped with ADVANCED AIRBAGS designed based on the US motor vehicle safety standards (FMVSS208). The airbag sensor assembly (ECU) controls airbag deployment based on information obtained from the sensors etc. shown in the system components diagram above. This information includes crash severity and occupant information. As the airbags deploy, a chemical reaction in the inflators quickly fills the airbags with non-toxic gas to help restrain the motion of the occupants.

 CAUTION

■ **SRS airbag precautions**

Observe the following precautions regarding the SRS airbags. Failure to do so may cause death or serious injury.

- The driver and all passengers in the vehicle must wear their seat belts properly.

The SRS airbags are supplemental devices to be used with the seat belts.

- The SRS driver airbag deploys with considerable force, and can cause death or serious injury especially if the driver is very close to the airbag. The National Highway Traffic Safety Administration (NHTSA) advises:

Since the risk zone for the driver's airbag is the first 2 - 3 in. (50 - 75 mm) of inflation, placing yourself 10 in. (250 mm) from your driver airbag provides you with a clear margin of safety. This distance is measured from the center of the steering wheel to your breastbone. If you sit less than 10 in. (250 mm) away now, you can change your driving position in several ways:

- Move your seat to the rear as far as you can while still reaching the pedals comfortably.
- Slightly recline the back of the seat. Although vehicle designs vary, many drivers can achieve the 10 in. (250 mm) distance, even with the driver seat all the way forward, simply by reclining the back of the seat somewhat. If reclining the back of your seat makes it hard to see the road, raise yourself by using a firm, non-slippery cushion, or raise the seat if your vehicle has that feature.
- If your steering wheel is adjustable, tilt it downward. This points the airbag toward your chest instead of your head and neck.

The seat should be adjusted as recommended by NHTSA above, while still maintaining control of the foot pedals, steering wheel, and your view of the instrument panel controls.

**⚠ CAUTION****■ SRS airbag precautions**

- If the seat belt extender has been connected to the front seat belt buckles but the seat belt extender has not also been fastened to the latch plate of the seat belt, the SRS front airbags will judge that the driver and front passenger are wearing the seat belt even though the seat belt has not been connected. In this case, the SRS front airbags may not activate correctly in a collision, resulting in death or serious injury in the event of a collision. Be sure to wear the seat belt with the seat belt extender.
- The SRS front passenger airbag also deploys with considerable force, and can cause death or serious injury especially if the front passenger is very close to the airbag. The front passenger seat should be as far from the airbag as possible with the seatback adjusted, so the front passenger sits upright.
- Improperly seated and/or restrained infants and children can be killed or seriously injured by a deploying airbag. An infant or child who is too small to use a seat belt should be properly secured using a child restraint system. Toyota strongly recommends that all infants and children be placed in the rear seats of the vehicle and properly restrained. The rear seats are safer for infants and children than the front passenger seat. (→P. 53)
- Do not sit on the edge of the seat or lean against the dashboard.

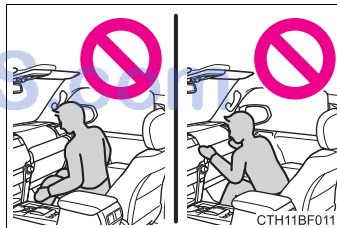
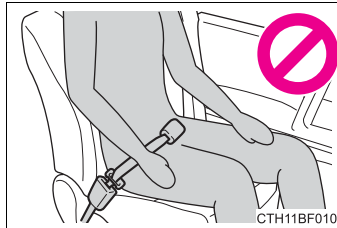

**CAUTION**

**SRS airbag precautions**

- Do not allow a child to stand in front of the SRS front passenger airbag unit or sit on the knees of a front passenger.
- Do not allow the front seat occupants to hold items on their knees.

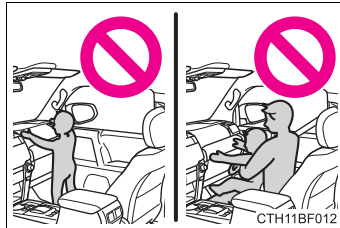

- Do not lean against the door, the roof side rail or the front, side and rear pillars.



- Do not allow anyone to kneel on the passenger seats toward the door or put their head or hands outside the vehicle.



- Do not attach anything to or lean anything against areas such as the dashboard, steering wheel pad and lower portion of the instrument panel. These items can become projectiles when the SRS driver, front passenger and knee airbags deploy.

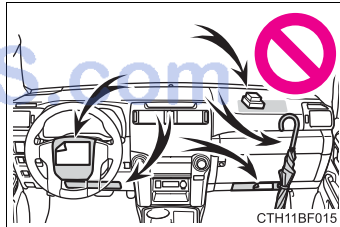

- Do not attach anything to areas such as a door, windshield glass, side door glass, front or rear pillar, roof side rail and assist grip.

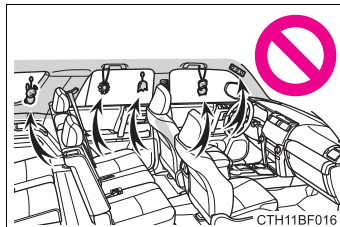

**⚠ CAUTION****■ SRS airbag precautions**

- Vehicles without a smart key system:  
Do not attach any heavy, sharp or hard objects such as keys and accessories to the key. The objects may restrict the SRS knee airbag inflation or be thrust into the driver's seat area by the force of the deploying airbag, thus causing a danger.

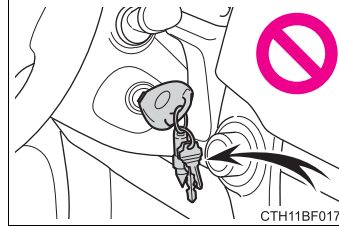

- Do not hang coat hangers or other hard objects on the coat hooks. All of these items could become projectiles and may cause death or serious injury, should the SRS curtain shield airbags deploy.
- If a vinyl cover is put on the area where the SRS knee airbag will deploy, be sure to remove it.
- Do not use seat accessories which cover the parts where the SRS side airbags inflate as they may interfere with inflation of the airbags. Such accessories may prevent the side airbags from activating correctly, disable the system or cause the side airbags to inflate accidentally, resulting in death or serious injury.
- Do not strike or apply significant levels of force to the area of the SRS airbag components.  
Doing so can cause the SRS airbags to malfunction.
- Do not touch any of the component parts immediately after the SRS airbags have deployed (inflated) as they may be hot.
- If breathing becomes difficult after the SRS airbags have deployed, open a door or window to allow fresh air in, or leave the vehicle if it is safe to do so. Wash off any residue as soon as possible to prevent skin irritation.
- If the areas where the SRS airbags are stored, such as the steering wheel pad and front and rear pillar garnishes, are damaged or cracked, have them replaced by your Toyota dealer.

 CAUTION

■ **Modification and disposal of SRS airbag system components**

Do not dispose of your vehicle or perform any of the following modifications without consulting your Toyota dealer. The SRS airbags may malfunction or deploy (inflate) accidentally, causing death or serious injury.

- Installation, removal, disassembly and repair of the SRS airbags
- Repairs, modifications, removal or replacement of the steering wheel, instrument panel, dashboard, seats or seat upholstery, front, side and rear pillars or roof side rails
- Repairs or modifications of the front fender, front bumper, or side of the occupant compartment
- Installation of a grill guard (bull bars, kangaroo bar etc.), snow plows, winches or roof luggage carrier.
- Modifications to the vehicle's suspension system
- Installation of electronic devices such as mobile two-way radios and CD players
- Modifications to your vehicle for a person with a physical disability

■ **If the SRS airbags deploy (inflate)**

- Bruising and slight abrasions may result from contact with a deploying (inflating) SRS airbag.
- A loud noise and white powder will be emitted.
- Parts of the airbag module (steering wheel hub, airbag cover and inflator) as well as the front seats, parts of the front and rear pillars, and roof side rails may be hot for several minutes. The airbag itself may also be hot.
- The windshield may crack.
- For Safety Connect subscribers, if the SRS airbags deploy or in the event of a severe rear-end collision, the system is designed to send an emergency call to the response center, notifying them of the vehicle's location (without needing to push the "SOS" button) and an agent will attempt to speak with the occupants to ascertain the level of emergency and assistance required. If the occupants are unable to communicate, the agent automatically treats the call as an emergency and helps to dispatch the necessary emergency services. (→P. 330)

### ■ SRS airbag deployment conditions (SRS front airbags)

- The SRS front airbags will deploy in the event of an impact that exceeds the set threshold level (the level of force corresponding to an approximately 12 - 18 mph [20 - 30 km/h] frontal collision with a fixed wall that does not move or deform).

However, this threshold velocity will be considerably higher in the following situations:

- If the vehicle strikes an object, such as a parked vehicle or sign pole, which can move or deform on impact
- If the vehicle is involved in an underride collision, such as a collision in which the front of the vehicle “underrides”, or goes under, the bed of a truck
- Depending on the type of collision, it is possible that only the seat belt pretensioners will activate.
- The SRS front airbags for the front passenger will not activate if there is no passenger sitting in the front passenger seat. However, the SRS front airbags for the front passenger may deploy if luggage is put in the seat, even if the seat is unoccupied. (→P. 46)

### ■ SRS airbag deployment conditions (SRS side and curtain shield airbags)

- The SRS side and curtain shield airbags will deploy in the event of an impact that exceeds the set threshold level (the level of force corresponding to the impact force produced by an approximately 3300 lb. [1500 kg] vehicle colliding with the vehicle cabin from a direction perpendicular to the vehicle orientation at an approximate speed of 12 - 18 mph [20 - 30 km/h]).
- The SRS curtain shield airbags will deploy in the event of vehicle rollover.
- The SRS curtain shield airbags may also deploy in the event of a severe frontal collision.

### ■ Conditions under which the SRS airbags may deploy (inflate), other than a collision

The SRS front airbags and SRS curtain shield airbags may also deploy if a serious impact occurs to the underside of your vehicle. Some examples are shown in the illustration.

- Hitting a curb, edge of pavement or hard surface
- Falling into or jumping over a deep hole
- Landing hard or falling

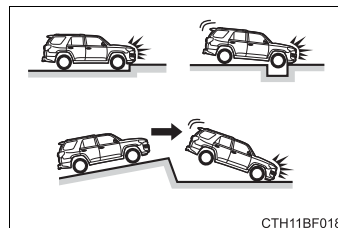

The SRS curtain shield airbags may also deploy under the situations shown in the illustration.

- The angle of vehicle tip-up is marginal.
- The vehicle skids and hits a curb stone.

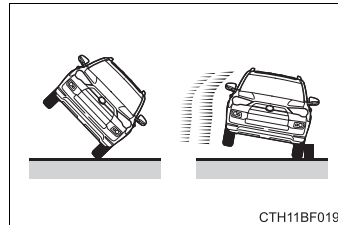

#### ■ Types of collisions that may not deploy the SRS airbags (SRS front airbags)

The SRS front airbags do not generally inflate if the vehicle is involved in a side or rear collision, if it rolls over, or if it is involved in a low-speed frontal collision. But, whenever a collision of any type causes sufficient forward deceleration of the vehicle, deployment of the SRS front airbags may occur.

- Collision from the side
- Collision from the rear
- Vehicle rollover

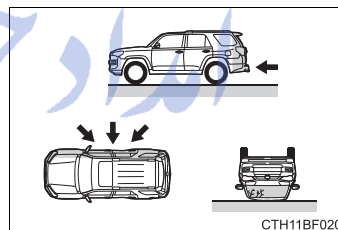

#### ■ Types of collisions that may not deploy the SRS airbags (SRS side and curtain shield airbags)

The SRS side and curtain shield airbags may not activate if the vehicle is subjected to a collision from the side at certain angles, or a collision to the side of the vehicle body other than the passenger compartment.

- Collision from the side to the vehicle body other than the passenger compartment
- Collision from the side at an angle

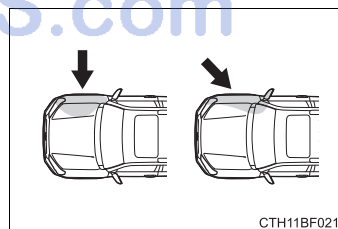

The SRS side airbags do not generally inflate if the vehicle is involved in a frontal or rear collision, if it rolls over, or if it is involved in a low-speed side collision.

- Collision from the front
- Collision from the rear
- Vehicle rollover

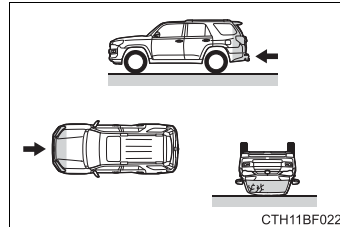

The SRS curtain shield airbags do not generally inflate if the vehicle is involved in a rear collision, if it pitches end over end, or if it is involved in a low-speed side or low-speed frontal collision.

- Collision from the rear
- Pitching end over end

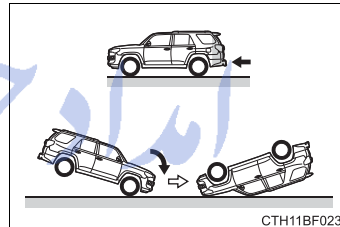

#### ■ When to contact your Toyota dealer

In the following cases, the vehicle will require inspection and/or repair. Contact your Toyota dealer as soon as possible. *تلفن شبانه روزی: ۰۲۰-۸۸۸۸۸۸۸۸*

- Any of the SRS airbags have been inflated.
- The front of the vehicle is damaged or deformed, or was involved in an accident that was not severe enough to cause the SRS airbags to inflate.

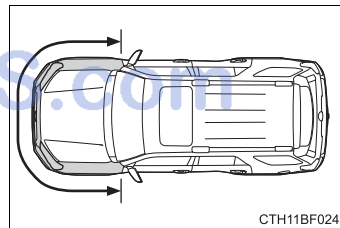

- A portion of a door or its surrounding area damaged or deformed, or the vehicle was involved in an accident that was not severe enough to cause the SRS side and curtain shield airbags to inflate.

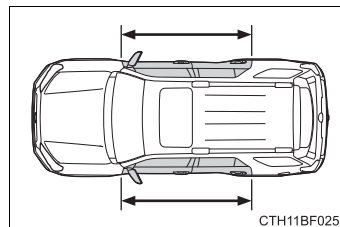



- The pad section of the steering wheel, dashboard near the front passenger airbag or lower portion of the instrument panel is scratched, cracked, or otherwise damaged.

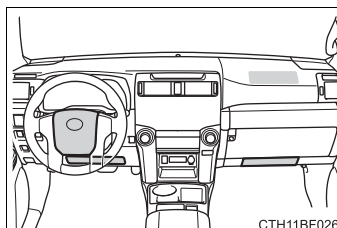

- The surface of the seats with the side airbag is scratched, cracked, or otherwise damaged.

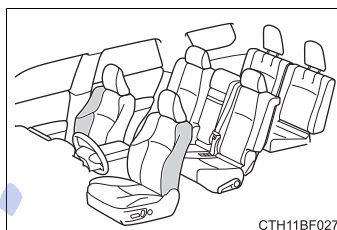

- The portion of the front pillars, rear pillars or roof side rail garnishes (padding) containing the curtain shield airbags inside is scratched, cracked, or otherwise damaged.

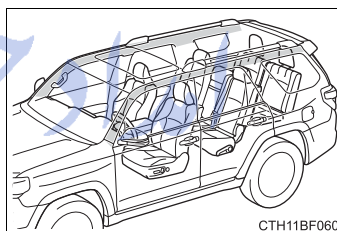

تلفن شبانه روزی: ۰۲۱-۸۸۸۶۲۰۸۵

FarmaSOS.com

## Front passenger occupant classification system

Your vehicle is equipped with a front passenger occupant classification system. This system detects the conditions of the front passenger seat and activates or deactivates the devices for the front passenger.

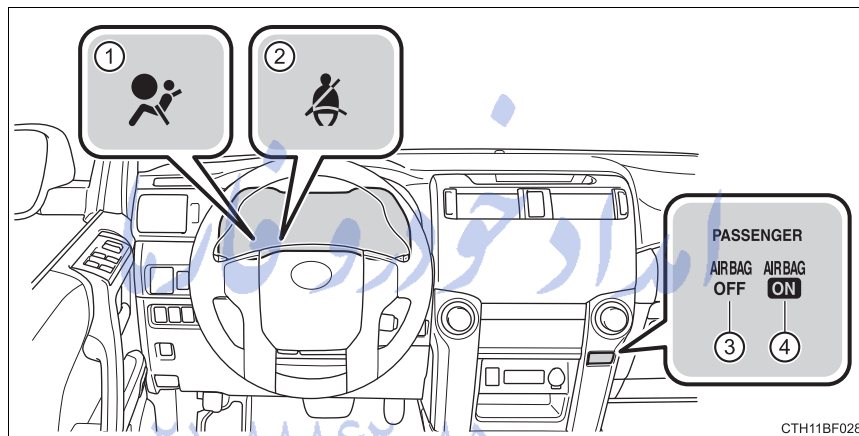

- ① SRS warning light
- ② Seat belt reminder light
- ③ "AIR BAG OFF" indicator light
- ④ "AIR BAG ON" indicator light

### Condition and operation in the front passenger occupant classification system

#### ■ Adult\*1

Indicator/ warning light	“AIR BAG ON” and “AIR BAG OFF” indicator lights	“AIR BAG ON”
	SRS warning light	Off
	Seat belt reminder light	Flashing*2
Devices	Front passenger airbag	Activated
	Side airbag on the front passenger seat	
	Curtain shield airbag in the front passenger side	
	Front passenger knee airbag	
	Front passenger's seat belt pretensioner	

#### ■ Child\*3 or child restraint system\*4

Indicator/ warning light	“AIR BAG ON” and “AIR BAG OFF” indicator lights	“AIR BAG OFF”*5
	SRS warning light	Off
	Seat belt reminder light	Flashing*2
Devices	Front passenger airbag	Deactivated
	Side airbag on the front passenger seat	Activated
	Curtain shield airbag in the front passenger side	
	Front passenger knee airbag	Deactivated
	Front passenger's seat belt pretensioner	Activated

■ **Unoccupied**

Indicator/ warning light	"AIR BAG ON" and "AIR BAG OFF" indicator lights	Not illuminated
	SRS warning light	Off
	Seat belt reminder light	
Devices	Front passenger airbag	Deactivated
	Side airbag on the front passenger seat	Activated
	Curtain shield airbag in the front passenger side	
	Front passenger knee airbag	Deactivated
	Front passenger's seat belt pretensioner	Activated* <sup>6</sup> or deactivated* <sup>7</sup>

تلفن شبانه روزی: ۰۲۱-۸۸۸۶۲۰۸۵

FarmaSOS.com

### ■ There is a malfunction in the system

Indicator/ warning light	“AIR BAG ON” and “AIR BAG OFF” indicator lights	“AIR BAG OFF”
	SRS warning light	On
	Seat belt reminder light	Flashing
Devices	Front passenger airbag	Deactivated
	Side airbag on the front passenger seat	Activated
	Curtain shield airbag in the front passenger side	
	Front passenger knee airbag	Deactivated
	Front passenger's seat belt pretensioner	Activated

\*1: The system judges a person of adult size as an adult. When a smaller adult sits in the front passenger seat, the system may recognize him/her as a child depending on his/her physique and posture.

\*2: In the event the front passenger does not wear a seat belt.

\*3: When a larger child who has outgrown a child restraint system sits in the front passenger seat, the system may recognize him/her as an adult depending on his/her physique or posture.

\*4: Never install a rear-facing child restraint system on the front passenger seat. A forward-facing child restraint system should only be installed on the front passenger seat when it is unavoidable.  
(→P. 53)

\*5: In case the indicator light is not illuminated, consult this manual on how to install the child restraint system properly. (→P. 57)

\*6: In the event of a side collision.

\*7: In the event of a frontal collision or vehicle rollover.

 CAUTION**■ Front passenger occupant classification system precautions**

Observe the following precautions regarding the front passenger occupant classification system.

Failure to do so may cause death or serious injury.

- Wear the seat belt properly.
- Make sure the front passenger's seat belt plate has not been left inserted into the buckle before someone sits in the front passenger seat.
- Make sure the "AIR BAG OFF" indicator light is not illuminated when using the seat belt extender for the front passenger seat. If the "AIR BAG OFF" indicator light is illuminated, disconnect the extender tongue from the seat belt buckle, and reconnect the seat belt. Reconnect the seat belt extender after making sure the "AIR BAG ON" indicator light is illuminated. If you use the seat belt extender while the "AIR BAG OFF" indicator light is illuminated, the SRS airbags for the front passenger will not activate correctly, which could cause death or serious injury in the event of a collision.
- Do not apply a heavy load to the front passenger seat or equipment (e.g. seatback pockets).
- Do not put weight on the front passenger seat by putting your hands or feet on the front passenger seat seatback from the rear passenger seat.
- Do not let a rear passenger lift the front passenger seat with their feet or press on the seatback with their legs.
- Do not put objects under the front passenger seat.

FarmaSOS.com

 CAUTION**■ Front passenger occupant classification system precautions**

- Do not recline the front passenger seatback so far that it touches a rear seat. This may cause the “AIR BAG OFF” indicator light to be illuminated, which indicates that the SRS airbags for the front passenger will not deploy in the event of a severe accident. If the seatback touches the rear seat, return the seatback to a position where it does not touch the rear seat. Keep the front passenger seatback as upright as possible when the vehicle is moving. Reclining the seatback excessively may lessen the effectiveness of the seat belt system.
- If an adult sits in the front passenger seat, the “AIR BAG ON” indicator light is illuminated. If the “AIR BAG OFF” indicator is illuminated, ask the passenger to sit up straight, well back in the seat, feet on the floor, and with the seat belt worn correctly. If the “AIR BAG OFF” indicator still remains illuminated, either ask the passenger to move to the rear seat, or if that is not possible, move the front passenger seat fully rearward.
- When it is unavoidable to install a forward-facing child restraint system on the front passenger seat, install the child restraint system on the front passenger seat in the proper order. (→P. 57)
- Do not modify or remove the front seats.
- Do not kick the front passenger seat or subject it to severe impact. Otherwise, the SRS warning light may come on to indicate a malfunction of the detection system. In this case, contact your Toyota dealer immediately.
- Child restraint systems installed on the second seat should not contact the front seatbacks.
- Do not use a seat accessory, such as a cushion and seat cover, that covers the seat cushion surface.
- Do not modify or replace the upholstery of the front seat.

## Safety information for children

**Observe the following precautions when children are in the vehicle.**

**Use a child restraint system appropriate for the child, until the child becomes large enough to properly wear the vehicle's seat belt.**

- It is recommended that children sit in the rear seats to avoid accidental contact with the shift lever, wiper switch etc.
- Use the rear door child-protector lock or the window lock switch to avoid children opening the door while driving or operating the power window accidentally.
- Do not let small children operate equipment which may catch or pinch body parts, such as the power window, hood, back door, seats etc.

### CAUTION

Never leave children unattended in the vehicle, and never allow children to have or use the key.

Children may be able to start the vehicle or shift the vehicle into neutral. There is also a danger that children may injure themselves by playing with the windows, the moon roof or other features of the vehicle. In addition, heat build-up or extremely cold temperatures inside the vehicle can be fatal to children.



## Child restraint systems

**A child restraint system for a small child or baby must itself be properly restrained on the seat with the lap portion of the lap/shoulder belt.**

**The laws of all 50 states of the U.S.A. and Canada now require the use of child restraint systems.**

### Points to remember

Studies have shown that installing a child restraint on a rear seat is much safer than installing one on the front passenger seat.

- Choose a child restraint system that suits your vehicle and is appropriate to the age and size of the child.
- For installation details, follow the instructions provided with the child restraint system.

General installation instructions are provided in this manual.

(→P. 57)

تلفن شبانه روزی: ۰۲۱-۸۸۸۶۲۰۸۵

FarmaSOS.com

### Types of child restraints

Child restraint systems are classified into the following 3 types according to the age and size of the child:

- ▶ Rear facing — Infant seat/convertible seat
- ▶ Forward facing — Convertible seat

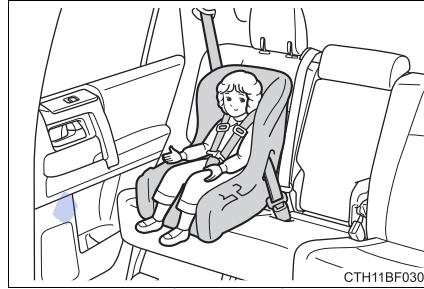

- ▶ Booster seat

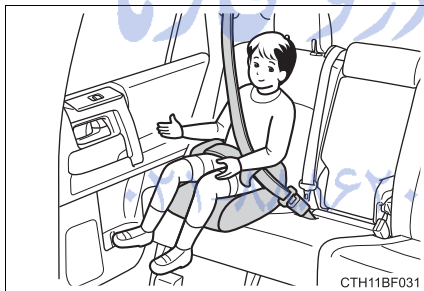

#### ■ Selecting an appropriate child restraint system

- Use a child restraint system appropriate for the child until the child becomes large enough to properly wear the vehicle's seat belt.
- If the child is too large for a child restraint system, sit the child on a rear seat and use the vehicle's seat belt. (→P. 30)

 CAUTION**■ Child restraint precautions**

- For effective protection in automobile accidents and sudden stops, a child must be properly restrained, using a seat belt or child restraint system depending on the age and size of the child. Holding a child in your arms is not a substitute for a child restraint system. In an accident, the child can be crushed against the windshield, or between you and the vehicle's interior.
- Toyota strongly urges the use of a proper child restraint system that conforms to the size of the child, installed on the rear seat. According to accident statistics, the child is safer when properly restrained in the rear seat than in the front seat.
- Never install a rear-facing child restraint system on the front passenger seat even if the "AIR BAG OFF" indicator light is illuminated. In the event of an accident, the force of the rapid inflation of the front passenger airbag can cause death or serious injury to the child if the rear-facing child restraint system is installed on the front passenger seat.
- A forward-facing child restraint system may be installed on the front passenger seat only when it is unavoidable. A child restraint system that requires a top tether strap should not be used in the front passenger seat since there is no top tether strap anchor for the front passenger seat. Adjust the seatback as upright as possible and always move the seat as far back as possible even if the "AIR BAG OFF" indicator light is illuminated, because the front passenger airbag could inflate with considerable speed and force. Otherwise, the child may be killed or seriously injured.
- Do not use the seat belt extender when installing a child restraint system on the front or rear passenger seat. If installing a child restraint system with the seat belt extender connected to the seat belt, the seat belt will not securely hold the child restraint system, which could cause death or serious injury to the child or other passengers in the event of an accident.
- Do not allow the child to lean his/her head or any part of his/her body against the door or the area of the seat, front and rear pillars or roof side rails from which the SRS side airbags or SRS curtain shield airbags deploy even if the child is seated in the child restraint system. It is dangerous if the SRS side airbags and curtain shield airbags inflate, and the impact could cause death or serious injury to the child.
- Make sure you have complied with all installation instructions provided by the child restraint manufacturer and that the system is properly secured. If it is not secured properly, it may cause death or serious injury to the child in the event of a sudden stop, sudden swerve or accident.

 CAUTION**■ When children are in the vehicle**

Do not allow children to play with the seat belt. If the seat belt becomes twisted around a child's neck, it may lead to choking or other serious injuries that could result in death.

If this occurs and the buckle cannot be unfastened, scissors should be used to cut the belt.

**■ When the child restraint system is not in use**

● Keep the child restraint system properly secured on the seat even if it is not in use. Do not store the child restraint system unsecured in the passenger compartment.

● If it is necessary to detach the child restraint system, remove it from the vehicle or store it securely in the luggage compartment. This will prevent it from injuring passengers in the event of a sudden stop, sudden swerve or accident.

امداد خودرو فارما

تلفن شبانه روزی: ۰۲۱-۸۸۸۶۲۰۸۵

FarmaSOS.com

## Installing child restraints

**Follow the child restraint system manufacturer's instructions. Firmly secure child restraints to the seats using the LATCH (Lower Anchors and Tethers for Children) anchors or a seat belt. Attach the top tether strap when installing a child restraint. The lap/shoulder belt can be used if your child restraint system is not compatible with the LATCH system.**

### ► Vehicles without third row seats

#### Child restraint LATCH anchors

LATCH anchors are provided for the outboard rear seats. (Buttons displaying the location of the anchors are attached to the seats.)

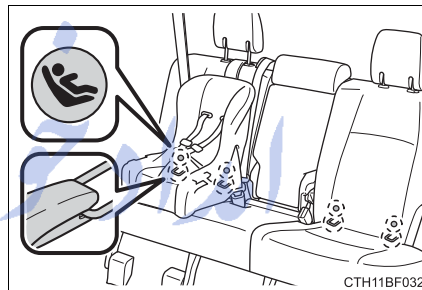

### ► Vehicles with third row seats

#### Child restraint LATCH anchors

LATCH anchors are provided for the outboard second row seats. (Buttons displaying the location of the anchors are attached to the seats.)

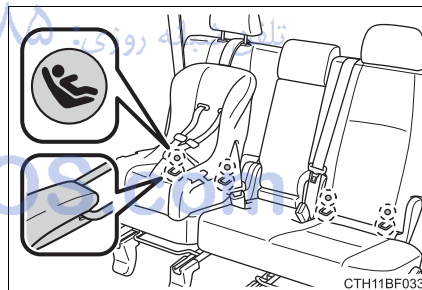

Seat belts equipped with a child restraint locking mechanism (ALR/ELR belts except driver's seat belt) (→P. 31)

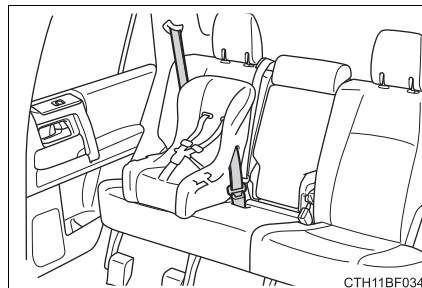

► Vehicles without third row seats

Anchor brackets (for top tether strap)

An anchor bracket is provided for each rear seat.

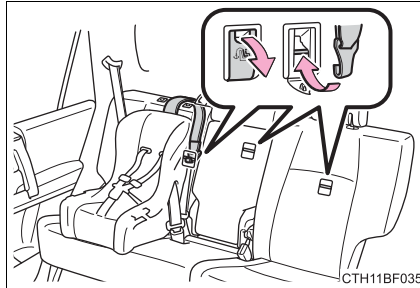

► Vehicles with third row seats

Anchor brackets (for top tether strap)

An anchor bracket is provided for each second row seat.

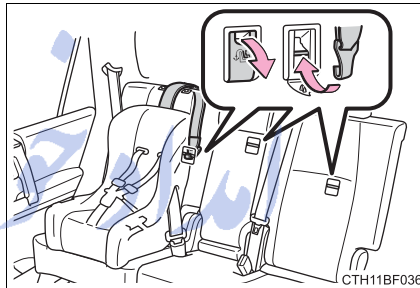

تلفن شبانه روزی: ۰۲۱-۸۸۸۶۲۰۸۵

FarmaSOS.com

### Installation with LATCH system (rear/second row seats only)

#### ■ Installing on the rear seats (vehicles without third row seats)

- 1 Fold the seatback while pulling the seatback angle adjustment lever. Return the seatback and secure it at the first lock position. (→P. 125)

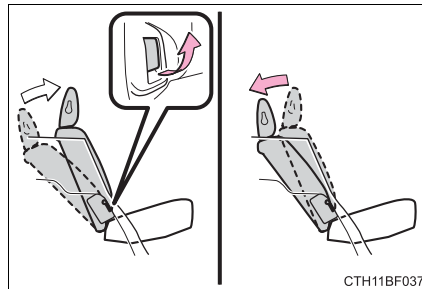

#### ► Type A

- 2 Latch the hooks of the lower straps onto the LATCH anchors. If the child restraint has a top tether strap, the top tether strap should be latched onto the top tether strap anchor.

For owners in Canada:

The symbol on a child restraint system indicates the presence of a lower connector system.

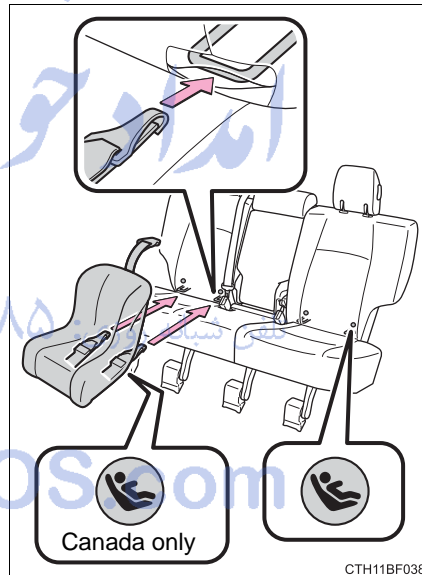

► Type B

- 2 Latch the buckles onto the LATCH anchors. If the child restraint has a top tether strap, the top tether strap should be latched onto the top tether strap anchor.

For owners in Canada:

The symbol on a child restraint system indicates the presence of a lower connector system.

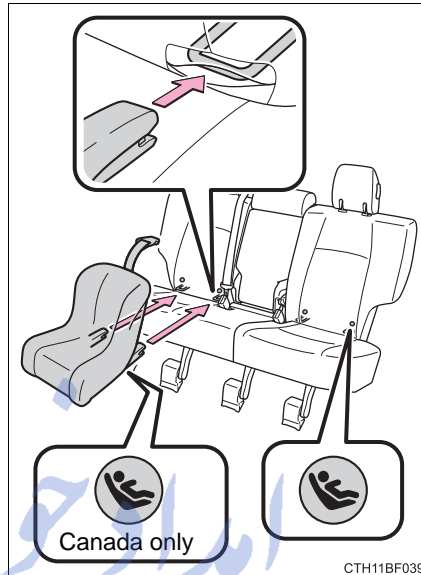

■ Installing on the second row seats (vehicles with third row seats)

- 1 Fold the seatback while pulling the seatback angle adjustment lever. Return the seatback and secure it at the first lock position. (→P. 125)
- 2 Flip the cover.

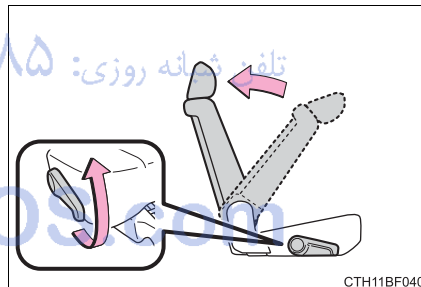



► Type A

- 3 Latch the hooks of the lower straps onto the LATCH anchors. If the child restraint has a top tether strap, the top tether strap should be latched onto the top tether strap anchor.

For owners in Canada:

The symbol on a child restraint system indicates the presence of a lower connector system.

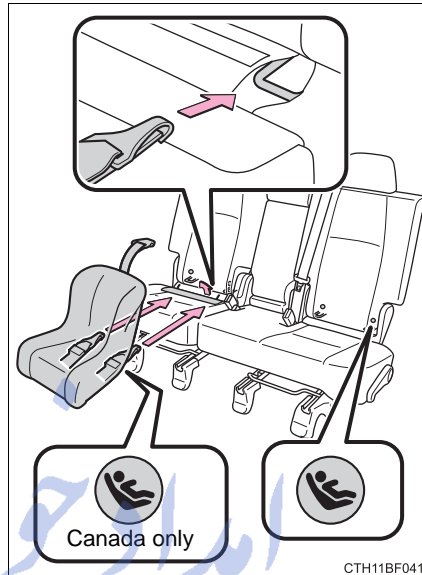

► Type B

- 3 Latch the buckles onto the LATCH anchors. If the child restraint has a top tether strap, the top tether strap should be latched onto the top tether strap anchor.

For owners in Canada:

The symbol on a child restraint system indicates the presence of a lower connector system.

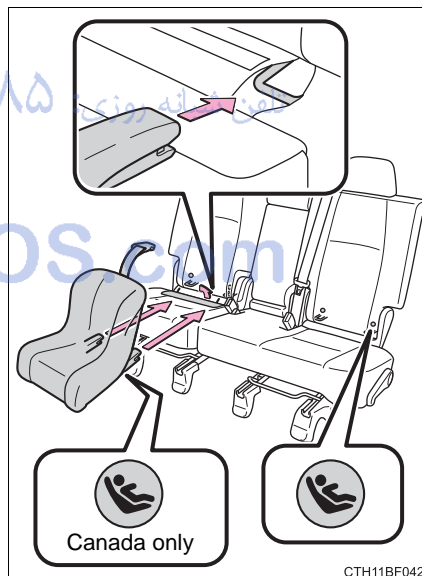

### Installing child restraints using a seat belt (child restraint lock function belt)

#### ■ Rear-facing — Infant seat/convertible seat

- 1 Place the child restraint system on the rear seat facing the rear of the vehicle.

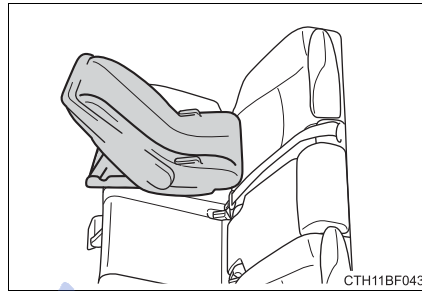

- 2 Run the seat belt through the child restraint system and insert the plate into the buckle. Make sure that the belt is not twisted.

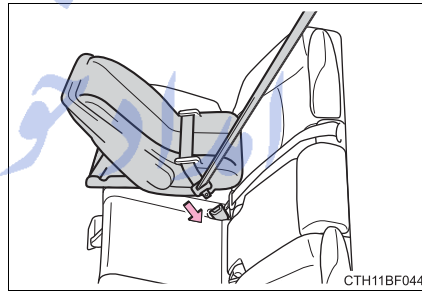

- 3 Fully extend the shoulder belt and allow it to retract to put it in lock mode. In lock mode, the belt cannot be extended.

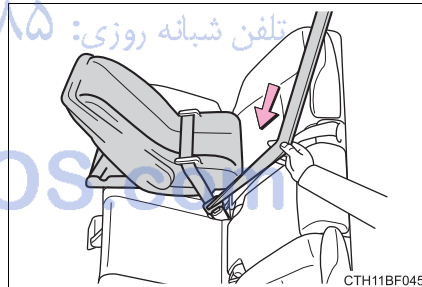

- 4 While pushing the child restraint system down into the rear seat, allow the shoulder belt to retract until the child restraint system is securely in place.

After the shoulder belt has retracted to a point where there is no slack in the belt, pull the belt to check that it cannot be extended.

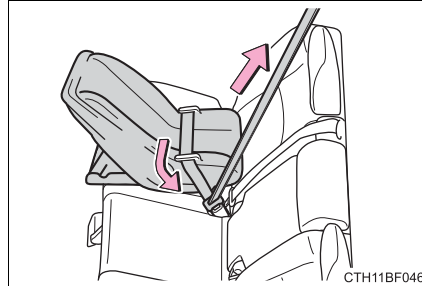

#### ■ Forward-facing — Convertible seat

- 1 Place the child restraint system on the seat facing the front of the vehicle.

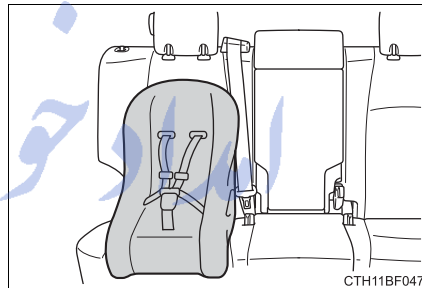

- 2 Run the seat belt through the child restraint system and insert the plate into the buckle. Make sure that the belt is not twisted.

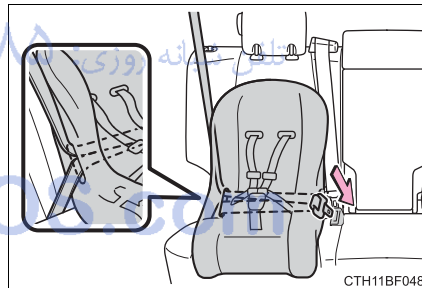

- 3 Fully extend the shoulder belt and allow it to retract to put it in lock mode. In lock mode, the belt cannot be extended.

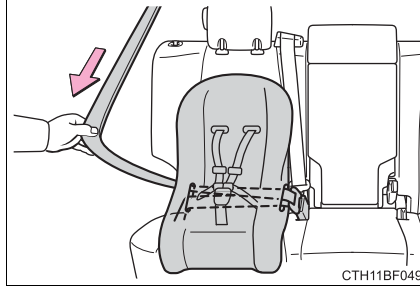

- 4 While pushing the child restraint system into the rear seat, allow the shoulder belt to retract until the child restraint system is securely in place.

After the shoulder belt has retracted to a point where there is no slack in the belt, pull the belt to check that it cannot be extended.

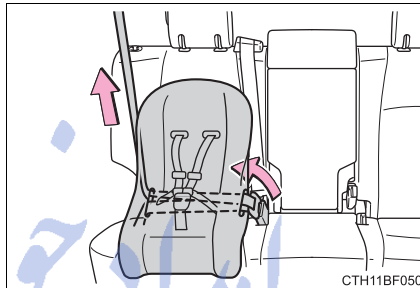

- 5 If the child restraint has a top tether strap, the top tether strap should be latched onto the top tether strap anchor. (→P. 66)

تلفن شبانه روزی: ۰۲۱-۸۸۸۶۲۰۸۵

FarmaSOS.com

**■ Booster seat**

- 1 Place the child restraint system on the seat facing the front of the vehicle.

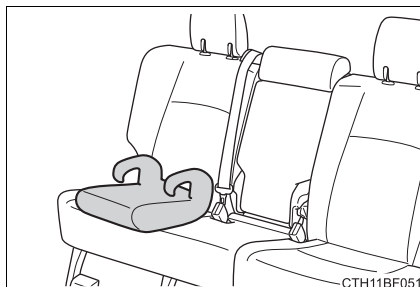

- 2 Sit the child in the child restraint system. Fit the seat belt to the child restraint system according to the manufacturer's instructions and insert the plate into the buckle. Make sure that the belt is not twisted.



Check that the shoulder belt is correctly positioned over the child's shoulder and that the lap belt is as low as possible. (→P. 30)

**Removing a child restraint installed with a seat belt**

Push the buckle release button and fully retract the seat belt.

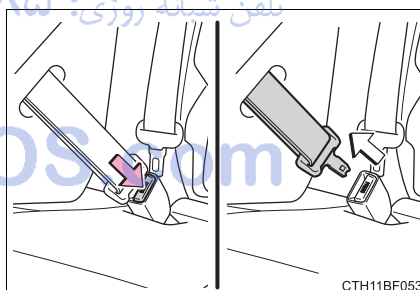

### Child restraint systems with a top tether strap

- 1 Secure the child restraint system using the seat belt or the lower anchors, and remove the head restraint.

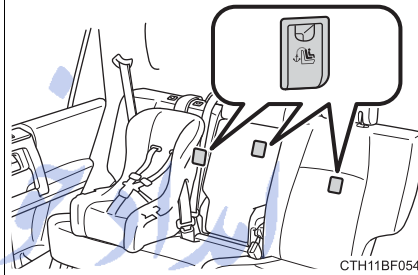
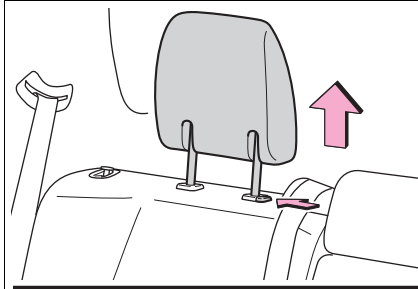

- 2 Open the anchor bracket cover, latch the hook onto the anchor bracket and tighten the top tether strap.

Make sure the top tether strap is securely latched.

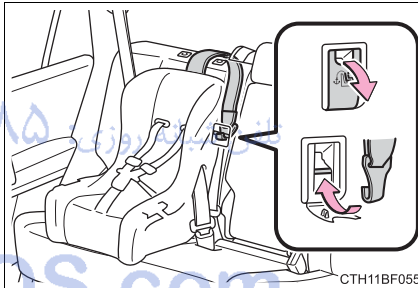

- 3 Replace the head restraint.

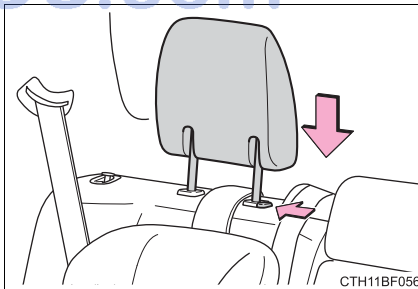

#### ■ Laws and regulations pertaining to anchorages

The LATCH system conforms to FMVSS225 or CMVSS210.2.

Child restraint systems conforming to FMVSS213 or CMVSS213 specifications can be used.

This vehicle is designed to conform to the SAE J1819.

**⚠ CAUTION**

■ **When installing a booster seat**

To prevent the belt from going into ALR lock mode, do not fully extend the shoulder belt. ALR mode causes the belt to tighten only. This could cause injury or discomfort to the child. (→P. 31)

■ **When installing a child restraint system**

Follow the directions given in the child restraint system installation manual and fix the child restraint system securely in place.

If the child restraint system is not correctly fixed in place, the child or other passengers may be seriously injured or even killed in the event of a sudden braking or an accident.

- If the driver's seat interferes with the child restraint system and prevents it from being attached correctly, attach the child restraint system to the right-hand rear seat.

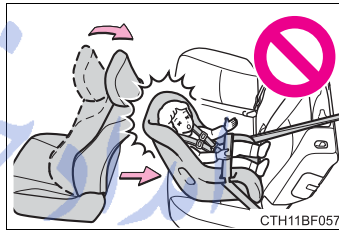

- Adjust the front passenger seat so that it does not interfere with the child restraint system.

- Only put a forward-facing child restraint system on the front seat when unavoidable. When installing a forward-facing child restraint system on the front passenger seat, move the seat as far back as possible even if the "AIR BAG OFF" indicator light is illuminated. Failure to do so may result in death or serious injury if the airbags deploy (inflate).

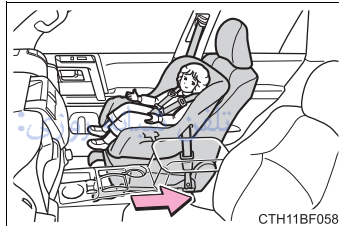

**⚠ CAUTION**

■ **When installing a child restraint system**

- Vehicles with third row seats: When using the LATCH anchors for a child restraint system, move the seat as far back as possible, with the seatback close to the child restraint system.
- When a booster seat is installed, always ensure that the shoulder belt is positioned across the center of the child's shoulder. The belt should be kept away from the child's neck, but not so that it could fall off the child's shoulder. Failing to do so may result in death or serious injury in the event of an accident or a sudden braking.
- Ensure that the belt and plate are securely locked and the seat belt is not twisted.
- Shake the child restraint system left and right, and forward and backward to ensure that it has been securely installed.
- After securing a child restraint system, never adjust the seat.
- Follow all installation instructions provided by the child restraint system manufacturer.

■ **Do not use a seat belt extender**

If a seat belt extender is used when installing a child restraint system, the seat belt will not securely hold the child restraint system, which could cause death or serious injury to the child or other passengers in the event of a sudden braking, sudden swerving or an accident.

■ **To correctly attach a child restraint system to the anchors**

- When using the LATCH anchors, be sure that there are no foreign objects around the anchors and that the seat belt is not caught behind the child restraint system. Make sure the child restraint system is securely attached, or it may cause death or serious injury to the child or other passengers in the event of a sudden braking or an accident.
- When using the left side LATCH anchors for the child restraint system, do not sit in the center seat. Seat belt function may be impaired, such as being positioned overly high or loose-fitting, which may result in death or serious injury in the event of sudden braking or an accident.

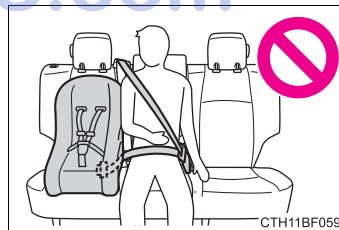



## Exhaust gas precautions

**Harmful substance to the human body is included in exhaust gases if inhale.**

### CAUTION

Exhaust gases include harmful carbon monoxide (CO), which is colorless and odorless. Observe the following precautions.

Failure to do so may cause exhaust gases enter the vehicle and may lead to an accident caused by light-headedness, or may lead to death or a serious health hazard.

#### ■ Important points while driving

- Keep the back door closed.
- If you smell exhaust gases in the vehicle even when the back door is closed, open the windows and have the vehicle inspected at your Toyota dealer as soon as possible.

#### ■ When parking

- If the vehicle is in a poorly ventilated area or a closed area, such as a garage, stop the engine.
- Do not leave the vehicle with the engine on for a long time.  
If such a situation cannot be avoided, park the vehicle in an open space and ensure that exhaust fumes do not enter the vehicle interior.
- Do not leave the engine running in an area with snow build-up, or where it is snowing. If snowbanks build up around the vehicle while the engine is running, exhaust gases may collect and enter the vehicle.

#### ■ Exhaust pipe

The exhaust system needs to be checked periodically. If there is a hole or crack caused by corrosion, damage to a joint or abnormal exhaust noise, be sure to have the vehicle inspected and repaired by your Toyota dealer.

## Engine immobilizer system

**The vehicle's keys have built-in transponder chips that prevent the engine from starting if a key has not been previously registered in the vehicle's on-board computer.**

**Never leave the keys inside the vehicle when you leave the vehicle.**

**This system is designed to help prevent vehicle theft but does not guarantee absolute security against all vehicle thefts.**

### ► Vehicles without a smart key system

The indicator light flashes after the key has been removed from the engine switch to indicate that the system is operating.

The indicator light stops flashing after the registered key has been inserted into the engine switch to indicate that the system has been canceled.

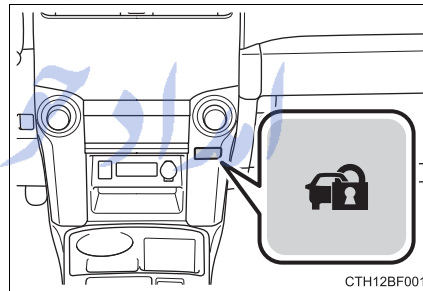

### ► Vehicles with a smart key system

The indicator light flashes after the engine switch has been turned off to indicate that the system is operating.

The indicator light stops flashing after the engine switch has been turned to ACCESSORY or IGNITION ON mode to indicate that the system has been canceled.

### ■ System maintenance

The vehicle has a maintenance-free type engine immobilizer system.

### ■ Conditions that may cause the system to malfunction

- If the grip portion of the key is in contact with a metallic object
- If the key is in close proximity to or touching a key to the security system (key with a built-in transponder chip) of another vehicle

■ **Certifications for the engine immobilizer system (vehicles without a smart key system)**

- ▶ For vehicles sold in the U.S.A.

FCC ID:MOZRI-33BTY

This device complies with part 15 of the FCC Rules. Operation is subject to the following two conditions: (1) This device may not cause harmful interference, and (2) this device must accept any interference received, including interference that may cause undesired operation.

- ▶ For vehicles sold in Canada

This device complies with Industry Canada licence-exempt RSS standard(s). Operation is subject to the following two conditions: (1) this device may not cause interference, and (2) this device must accept any interference, including interference that may cause undesired operation of the device.

■ **Certifications for the engine immobilizer system (vehicles with a smart key system)**

- ▶ For vehicles sold in the U.S.A.

FCC ID: NI4TMIMB-1

This device complies with part 15 of the FCC Rules. Operation is subject to the following two conditions: (1) This device may not cause harmful interference, and (2) this device must accept any interference received, including interference that may cause undesired operation.

- ▶ For vehicles sold in Canada

This device complies with Industry Canada licence-exempt RSS standard(s). Operation is subject to the following two conditions: (1) this device may not cause interference, and (2) this device must accept any interference, including interference that may cause undesired operation of the device.

 **CAUTION**

■ **Certifications for the engine immobilizer system**

Changes or modifications not expressly approved by the party responsible for compliance could void the user's authority to operate the equipment.

 **NOTICE**

■ **To ensure the system operates correctly**

Do not modify or remove the system. If modified or removed, the proper operation of the system cannot be guaranteed.

## Alarm\*

### The alarm

The alarm uses light and sound to give an alert when an intrusion is detected.

The alarm is triggered in the following situations when the alarm is set:

- A locked door is unlocked or opened in any way other than using the entry function, wireless remote control or mechanical key. (The doors will lock again automatically.)
- The hood is opened.

### Setting the alarm system

Close the doors and hood, and lock all the doors. The system will be set automatically after 30 seconds.

The indicator light changes from being on to flashing when the system is set.

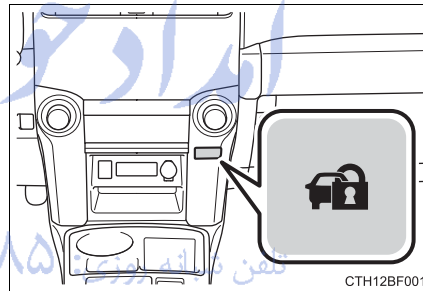

### Deactivating or stopping the alarm

Do one of the following to deactivate or stop the alarms:

- Unlock the doors.
- Start the engine. (The alarm will be deactivated or stopped after a few seconds.)

\*: If equipped

### ■ System maintenance

The vehicle has a maintenance-free type alarm system.

### ■ Items to check before locking the vehicle

To prevent unexpected triggering of the alarm and vehicle theft, make sure of the following:

- Nobody is in the vehicle.
- The windows and moon roof are closed before the alarm is set.
- No valuables or other personal items are left in the vehicle.

### ■ Triggering of the alarm

The alarm may be triggered in the following situations:  
(Stopping the alarm deactivates the alarm system.)

- A person inside the vehicle opens a door or the hood.

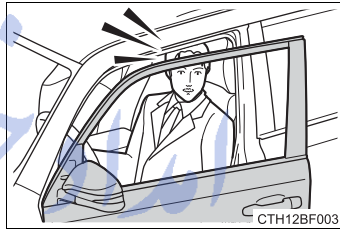

- The battery is recharged or replaced when the vehicle is locked.

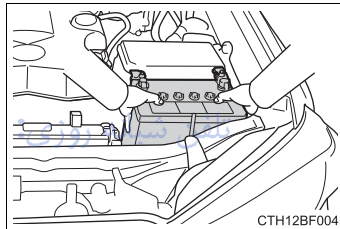

### ■ Alarm-operated door lock

- When the alarm is operating, the doors are locked automatically to prevent intruders.
- Do not leave the key inside the vehicle when the alarm is operating, and make sure the key is not inside the vehicle when recharging or replacing the battery.

#### ⚠ NOTICE

#### ■ To ensure the system operates correctly

Do not modify or remove the system. If modified or removed, the proper operation of the system cannot be guaranteed.

امداد خودرو فارما

تلفن شبانه روزی: ۰۲۱-۸۸۸۶۲۰۸۵

**FarmaSOS.com**

**2. Instrument cluster**

Warning lights and indicators .....	76
Gauges and meters .....	81
Multi-information display .....	83
Accessory meter .....	89

امداد خودرو فارما

تلفن شبانه روزی: ۰۲۱-۸۸۸۶۲۰۸۵

FarmaSOS.com

## Warning lights and indicators

The warning lights and indicators on the instrument cluster and center panel inform the driver of the status of the vehicle's various systems.

For the purpose of explanation, the following illustration displays all warning lights and indicators illuminated.

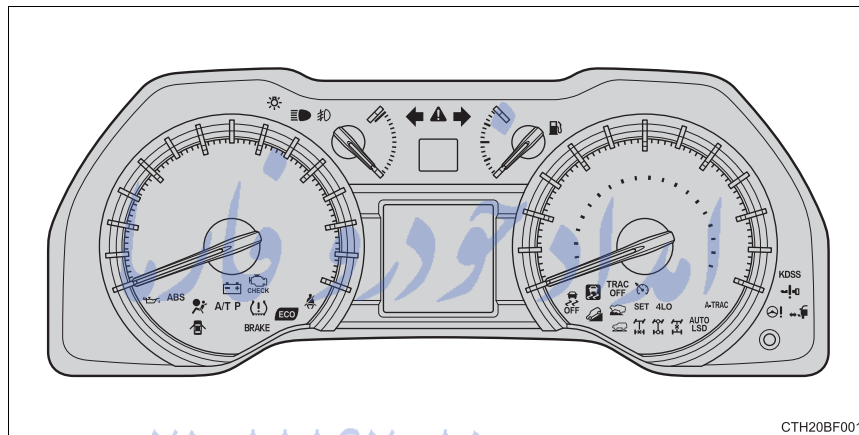

















The units used on the speedometer and some indicators may differ depending on where the vehicle is sold.











FarmaSOS.com



## Warning lights

Warning lights inform the driver of malfunctions in the indicated vehicle's systems.

<p>*<sub>1</sub></p>  <p><b>BRAKE</b> (U.S.A.)</p>	<p>*<sub>1</sub></p> <p>Brake system warning light (→P. 418)</p>	<p>*<sub>2</sub></p> 	<p>*<sub>2</sub></p> <p>Cruise control indicator light (→P. 419)</p>
<p>*<sub>1</sub></p>  <p>(Canada)</p>	<p>*<sub>1</sub></p> <p>Brake system warning light (→P. 418)</p>	<p>*<sub>1</sub></p> 	<p>*<sub>1</sub></p> <p>Slip indicator (→P. 419)</p>
<p>*<sub>1</sub></p> 	<p>*<sub>1</sub></p> <p>Charging system warning light (→P. 418)</p>	<p>*<sub>3</sub></p>  <p>(if equipped)</p>	<p>*<sub>3</sub></p> <p>Four-wheel drive indicator light (→P. 419)</p>
<p>*<sub>1</sub></p>  <p>(U.S.A.)</p>	<p>*<sub>1</sub></p> <p>Malfunction indicator lamp (→P. 418)</p>	<p>*<sub>3</sub></p>  <p>(if equipped)</p>	<p>*<sub>3</sub></p> <p>Low speed four-wheel drive indicator light (→P. 420)</p>
<p>*<sub>1</sub></p>  <p>(Canada)</p>	<p>*<sub>1</sub></p> <p>Malfunction indicator lamp (→P. 418)</p>	<p>*<sub>3</sub></p>  <p>(if equipped)</p>	<p>*<sub>3</sub></p> <p>Rear differential lock indicator light (→P. 419)</p>
<p>*<sub>1</sub></p> 	<p>*<sub>1</sub></p> <p>SRS warning light (→P. 419)</p>	<p>*<sub>3</sub></p>  <p>(if equipped)</p>	<p>*<sub>3</sub></p> <p>Center differential lock indicator light (→P. 420)</p>
<p>*<sub>1</sub></p>  <p>(U.S.A.)</p>	<p>*<sub>1</sub></p> <p>ABS warning light (→P. 419)</p>	<p>*<sub>4</sub></p>  <p>(if equipped)</p>	<p>*<sub>4</sub></p> <p>Multi-terrain Select indicator light (→P. 420)</p>
<p>*<sub>1</sub></p>  <p>(Canada)</p>	<p>*<sub>1</sub></p> <p>ABS warning light (→P. 419)</p>	<p>(if equipped)</p>  <p>(if equipped)</p>	<p>Smart key system warning light (→P. 426)</p>

	Open door warning light (→P. 420)		<sup>*1</sup> Master warning light (→P. 426)
	Low fuel level warning light (→P. 420)		<sup>*1</sup> Tire pressure warning light (→P. 421)
	Seat belt reminder light (→P. 421)		<sup>*1</sup> Unengaged "Park" warning light (→P. 420)
	<sup>*1</sup> Low engine oil pressure warning light (→P. 418)		<sup>*1</sup> KDSS warning light (→P. 420)
	<sup>*1</sup> Power steering warning light (→P. 420)		<sup>*1, 2</sup> Automatic running boards indicator light (→P. 420)

<sup>\*1</sup>: These lights turn on when the engine switch is turned to IGNITION ON mode (vehicles with a smart key system) or the engine switch is turned to the "ON" position (vehicles without a smart key system) to indicate that a system check is being performed. They will turn off after the engine is started, or after a few seconds. There may be a malfunction in a system if the lights do not come on, or do not turn off. Have the vehicle inspected by your Toyota dealer.



















<sup>\*2</sup>: The light flashes to indicate a malfunction.





<sup>\*3</sup>: The light flashes rapidly to indicate a malfunction.

<sup>\*4</sup>: The light flashes continuously to indicate a malfunction.

## Indicators

The indicators inform the driver of the operating state of the vehicle's various systems.

	Turn signal indicator (→P. 203)	<sup>*1, 2</sup> 	Slip indicator (→P. 261)
	Headlight indicator (→P. 205) (U.S.A.)	<sup>*1</sup> 	VSC OFF indicator (→P. 262)
	Tail light indicator (→P. 205) (Canada)	<sup>*1, 4</sup> 	"AIR BAG ON/OFF" indicator (→P. 46)
	Headlight high beam indicator (→P. 208)		Cruise control set indicator (→P. 222)
	Front fog light indicator (→P. 211)	 (if equipped)	Four-wheel drive indicator (→P. 232)
<sup>*4</sup> 	Security indicator (→P. 70, 72)	<sup>*1</sup>  (if equipped)	Downhill assist control system indicator (→P. 247)
<sup>*1, 3</sup> 	Eco Driving Indicator Light (→P. 87)	 (if equipped)	Low speed four-wheel drive indicator (→P. 232, 236)
<sup>*1</sup> 	"TRAC OFF" indicator (→P. 262)	 (if equipped)	Rear differential lock indicator (→P. 244)
	Cruise control indicator (→P. 222)	 (if equipped)	Center differential lock indicator (→P. 236)

 (if equipped)	“A-TRAC” indicator (→P. 240)	 (if equipped)	Crawl Control indicator (→P. 250)
 (if equipped)	“AUTO LSD” indicator (→P. 242)	 (if equipped)	Automatic running boards indicator (→P. 114)
 (if equipped)	Multi-terrain Select indicator (→P. 253)		

\*1: These lights turn on when the engine switch is turned to the “ON” position (vehicles without a smart key system) or the engine switch is turned to IGNITION ON mode (vehicles with a smart key system) to indicate that a system check is being performed. They will turn off after the engine is started, or after a few seconds. There may be a malfunction in a system if the lights do not come on, or do not turn off. Have the vehicle inspected by your Toyota dealer.

\*2: The light flashes to indicate that the system is operating.

\*3: The light does not turn on when the system is disabled.

\*4: This light illuminates on the center panel.

#### CAUTION

##### **■ If a safety system warning light does not come on**

Should a safety system light such as the ABS and SRS warning light not come on when you start the engine, this could mean that these systems are not available to help protect you in an accident, which could result in death or serious injury. Have the vehicle inspected by your Toyota dealer immediately if this occurs.

## Gauges and meters

The displayed content may differ depending on the type of meter.

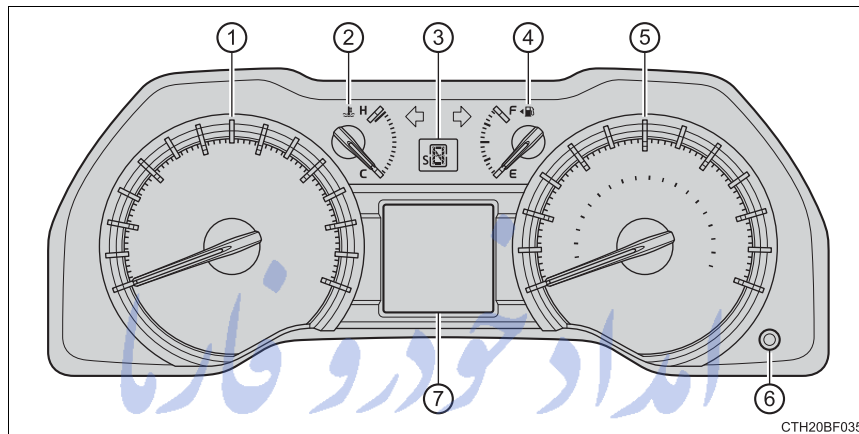

- ① Tachometer  
Displays the engine speed in revolutions per minute
- ② Engine coolant temperature gauge  
Displays the engine coolant temperature
- ③ Shift position and shift range  
Displays the selected shift position or selected shift range (→P. 200)
- ④ Fuel gauge  
Displays the quantity of fuel remaining in the tank
- ⑤ Speedometer  
Displays the vehicle speed
- ⑥ Odometer/trip meter display change button  
Switches the trip information.
- ⑦ Multi-information display  
Presents the driver with a variety of vehicle data →P. 83

2

Instrument cluster

### Instrument panel light control

The brightness of the instrument panel lights can be adjusted.

- ① Brighter
- ② Darker

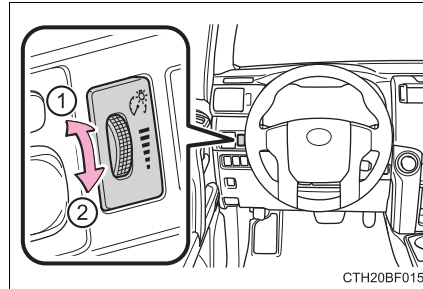

#### ■ The meters and display illuminate when

- ▶ Vehicles without a smart entry & start system  
The engine switch is in the "ON" position.
- ▶ Vehicles with a smart entry & start system  
The engine switch is in IGNITION ON mode.

#### ■ The brightness of the instrument panel lights

When the headlight switch is turned to on, the brightness will be reduced slightly unless the control dial is turned fully upward.



#### NOTICE

#### ■ To prevent damage to the engine and its components

- Do not let the indicator needle of the tachometer enter the red zone, which indicates the maximum engine speed.
- The engine may be overheating if the engine coolant temperature gauge is in the red zone (H). In this case, immediately stop the vehicle in a safe place, and check the engine after it has cooled completely. (→P. 455)

## Multi-information display

### Display contents

The multi-information display presents the driver with a variety of driving-related data.

- ① Driving monitor (→P. 84)
- ② Eco Driving Indicator Zone Display (→P. 87)
- ③ Warning messages (→P. 426)
- ④ Outside temperature display (→P. 312)
- ⑤ Trip information (→P. 83)
- ⑥ Ice indicator (→P. 312)
- ⑦ Compass\* (→P. 85)

\*: Vehicles with a navigation system

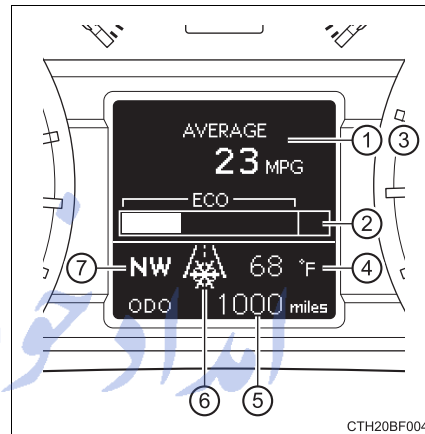

CTH20BF004

2

Instrument cluster

### Trip information

#### ■ Switching the display

Items displayed can be switched by pressing the display change button.

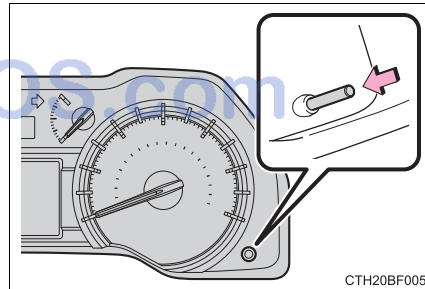

CTH20BF005

#### ■ Odometer

Displays the total distance the vehicle has been driven.

#### ■ Trip meter A/trip meter B

Displays the distance the vehicle has been driven since the meter was last reset. Trip meters A and B can be used to record and display different distances independently.

Press and hold the display change button to reset.

### Driving monitor

#### ■ Switching the display

Items displayed can be switched by pressing the “DISP” switch.

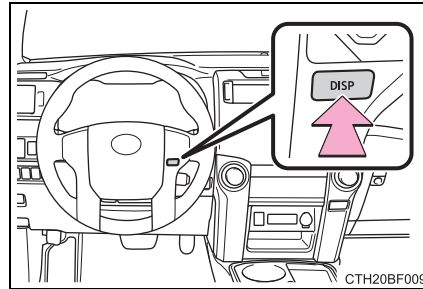

#### ■ Average fuel consumption

Displays the average fuel consumption since the function was reset

- Press and hold the “DISP” switch to reset when the average fuel consumption is displayed.
- Use the displayed average fuel consumption as a reference.

#### ■ Current fuel consumption.

Displays the current rate of fuel consumption

Use the displayed current fuel consumption as a reference.

#### ■ Cruising range

Displays the estimated maximum distance that can be driven with the quantity of fuel remaining

- This distance is computed based on your average fuel consumption. As a result, the actual distance that can be driven may differ from that displayed.
- When only a small amount of fuel is added to the tank, the display may not be updated.  
When refueling, turn the engine switch off. If the vehicle is refueled without turning the engine switch off, the display may not be updated.

#### ■ Elapsed time

Displays the elapsed time since it was last reset

Press and hold the “DISP” switch to reset when the elapsed time is displayed.

#### ■ Speedometer

Displays the vehicle speed



### ■ Front tire angle

Displays the direction of the front tires

The tire direction is displayed in 3 stages for both left and right, in accordance with the angle of the tire.

### ■ Customization

Language, units and Eco Driving Indicator Light settings can be changed. (→P. 86)

## Compass (vehicles with a navigation system)

Display the direction in which the vehicle is heading.

### ■ Displays and directions

Display	Direction
"N"	North
"NE"	Northeast
"E"	East
"SE"	Southeast
"S"	South
"SW"	Southwest
"W"	West
"NW"	Northwest

### Customizing vehicle features

It is possible to customize the language, units and Eco Driving Indicator Light settings using the “DISP” switch.

When customizing vehicle features, ensure that the vehicle is parked in a safe place with the shift the shift lever to P and the parking brake set.

- 1 Press the “DISP” switch to display the setting screen while the vehicle is stopped, and then press and hold the “DISP” switch to display the customize mode screen.

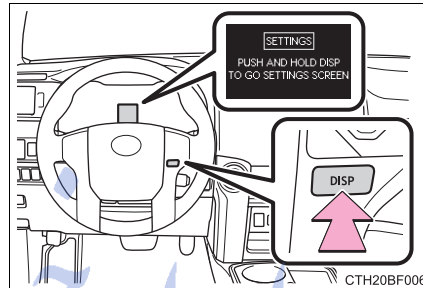

- 2 Press the “DISP” switch to select the item to be set, then press and hold the “DISP” switch.



- 3 Press the “DISP” switch to select the desired setting, and then press and hold the “DISP” switch.



To go back to the previous screen or exit the customize mode, press the “DISP” switch to select “EXIT”, and then press and hold the “DISP” switch.

● Items that can be changed

Function	Default setting	Customized setting
Language	English	French
		Spanish
Units	"miles"*	"km (L/100km)"
"ECO LAMP" (Eco Driving Indicator Light)	ON (Self-lighting)	OFF

\*: The default setting varies according to countries.

■ Eco Driving Indicator

- ① Eco Driving Indicator Light  
During Eco-friendly acceleration (Eco driving), Eco Driving Indicator Light will turn on.
- ② Eco Driving Indicator Zone Display  
Suggests Zone of Eco driving with current Eco driving ratio based on acceleration.
- ③ Zone of Eco driving
- ④ Eco driving ratio based on acceleration  
If the vehicle exceeds Zone of Eco driving, the right side of Eco Driving Indicator Zone Display will blink and Eco Driving Indicator Light will turn off.

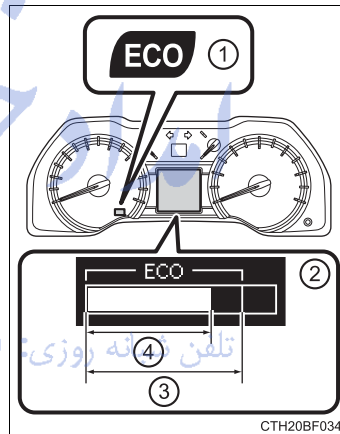

Eco Driving Indicator Light will not operate in the following conditions:

- The shift lever is in anything other than D.
- The vehicle speed is approximately 80 mph (130 km/h) or higher.

■ When disconnecting and reconnecting battery terminals

The following information data will be reset:

- Trip meter
- Elapsed time
- Average fuel consumption

If the trip meter was displayed last, the odometer will be displayed after resetting.

**■ Liquid crystal display**

Small spots or light spots may appear on the display. This phenomenon is characteristic of liquid crystal displays, and there is no problem continuing to use the display.

**■ Setting display automatic suspension**

In the following situations, the setting display will be suspended.

- When a message appears.
- When the vehicle begins to move.

**⚠ CAUTION****■ The display at low temperatures**

Allow the interior of the vehicle to warm up before using the display. At extremely low temperatures, the display monitor may respond slowly, and display changes may be delayed.

**■ Cautions during setting up the display**

As the engine needs to be running during setting up the display, ensure that the vehicle is parked in a place with adequate ventilation. In a closed area such as a garage, exhaust gases including harmful carbon monoxide (CO) may collect and enter the vehicle. This may lead to death or a serious health hazard.

تلفن شبانه روزی: ۰۲۱-۸۸۶۲۰۸۵

FarmaSOS.com

## Accessory meter\*

The accessory meter presents the driver with a variety of driving-related data including the current outside air temperature.

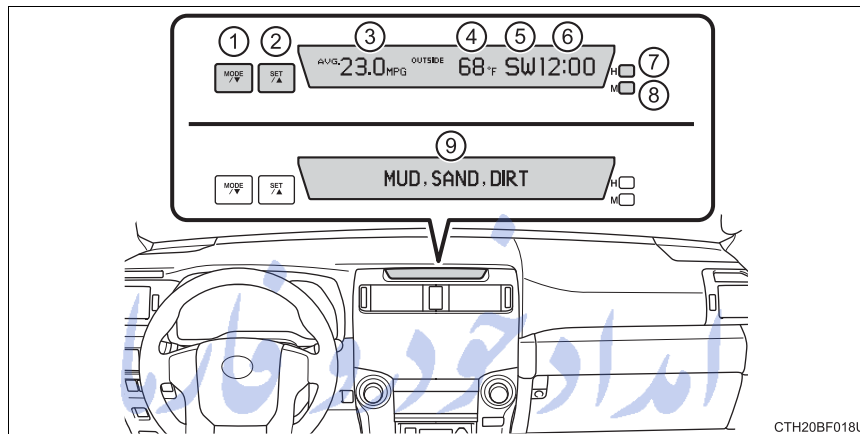

- ① “MODE/▼” button
- ② “SET/▲” button
- ③ Trip information (→P. 90)  
Displays driving range and average fuel consumption
- ④ Outside temperature display (→P. 312)
- ⑤ Compass (→P. 335)
- ⑥ Clock (→P. 311)
- ⑦ H (Hour) button (→P. 311)
- ⑧ M (Minute) button (→P. 311)
- ⑨ Multi-terrain Select display (→P. 253)  
Automatically displayed when using Multi-terrain Select

\*: If equipped

### Trip information

Items displayed can be switched by pressing the “MODE/▼” button.

#### ■ Cruising range

Displays the estimated maximum distance that can be driven with the quantity of fuel remaining

- This distance is computed based on your average fuel consumption. As a result, the actual distance that can be driven may differ from that displayed.
- When only a small amount of fuel is added to the tank, the display may not be updated.

#### ■ Average fuel consumption

Displays the average fuel consumption since the function was reset

- Pressing and holding the “SET/▲” button will reset the average fuel consumption.
- Use the displayed average fuel consumption as a reference.

### Accessory meter light control

The daytime brightness of the accessory meter can be adjusted.

- 1 Turn the headlight switch off.
- 2 Press and hold the “MODE/▼” button.
- 3 Press the “MODE/▼” or “SET/▲” button to the desired brightness level.
- 4 Press and hold the “SET/▲” button.

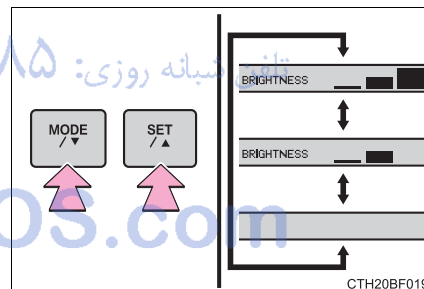

**■ Adjusting the brightness of the accessory meter**

- If left idle for approximately 6 seconds or more while adjusting, the display will revert to the trip information display.
- When the parking lights are on, the brightness of the accessory meter can be adjusted only with the instrument panel light control.
- If the “MODE/ ▼” button is pressed and held when the accessory meter light control is displayed, the display will switch to compass calibration. (→P. 335)

**■ Liquid crystal display**

Small spots or light spots may appear on the display. This phenomenon is characteristic of liquid crystal displays, and there is no problem with continuing to use the display.

 **NOTICE****■ The accessory meter at low temperatures**

Allow the interior of the vehicle to warm up before using the liquid crystal display. At extremely low temperatures, the display monitor may respond slowly, and display changes may be delayed.

تلفن شبانه روزی: ۰۲۱-۸۸۶۲۰۸۵

FarmaSOS.com

امداد خودرو فارما

تلفن شبانه روزی: ۰۲۱-۸۸۸۶۲۰۸۵

**FarmaSOS.com**



## Operation of each component

### 3

#### 3-1. Key information

Keys .....	94
Side doors.....	100

#### 3-2. Opening, closing and locking the doors

Smart key system .....	107
Automatic running boards.....	114
Back door.....	117

#### 3-3. Adjusting the seats

Front seats .....	122
Rear seats.....	125
Driving position memory .....	135
Head restraints.....	139

#### 3-4. Adjusting the steering wheel and mirrors

Steering wheel .....	142
Inside rear view mirror .....	144
Outside rear view mirrors.....	146

#### 3-5. Opening, closing the windows and moon roof

Power windows .....	148
Power back window .....	151
Moon roof.....	155

## Keys

### The keys

#### ▶ Vehicles without a smart key system

- ① Master keys
  - Operating the wireless remote control function
- ② Valet key
- ③ Key number plate

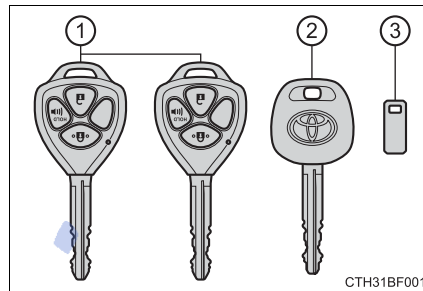

#### ▶ Vehicles with a smart key system

The following keys are provided with the vehicle.

- ① Electronic keys
  - Operating the smart key system (→P. 107)
  - Operating the wireless remote control function
- ② Mechanical keys
- ③ Key number plate

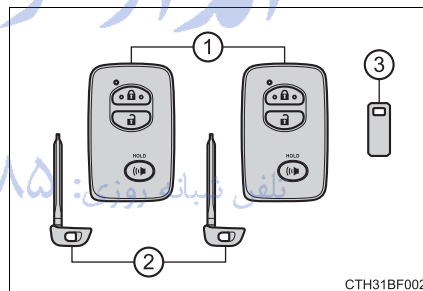

FarmaSOS.com

**Wireless remote control (if equipped)**

## ▶ Vehicles without a smart key system

- ① Locks all the doors (→P. 100)
- ② Sounds the alarm (press and hold) (→P. 96)
- ③ Unlocks all the doors (→P. 100)

Pressing the button unlocks the driver's door. Pressing the button again within 3 seconds unlocks the other doors.

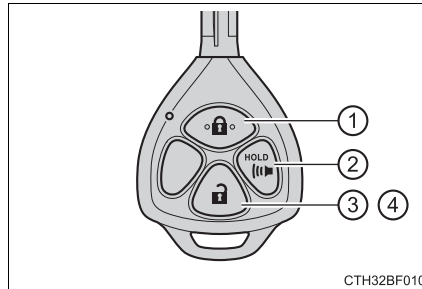

- ④ Opens the windows and moon roof (press and hold)\*

\*: This setting must be customized at your Toyota dealer.

## ▶ Vehicles with a smart key system

- ① Locks all the doors (→P. 100)
- ② Unlocks all the doors (→P. 100)

Pressing the button unlocks the driver's door. Pressing the button again within 3 seconds unlocks the other doors.

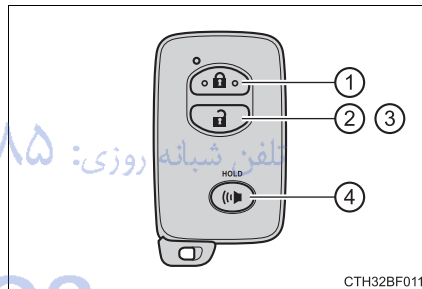

- ③ Opens the windows and moon roof (press and hold)\*

- ④ Sounds the alarm (press and hold) (→P. 96)

\*: This setting must be customized at your Toyota dealer.

### Using the mechanical key (vehicles with a smart key system)

To take out the mechanical key, push the release button and take the key out.

The mechanical key can only be inserted in one direction, as the key only has grooves on one side. If the key cannot be inserted in a lock cylinder, turn it over and re-attempt to insert it.

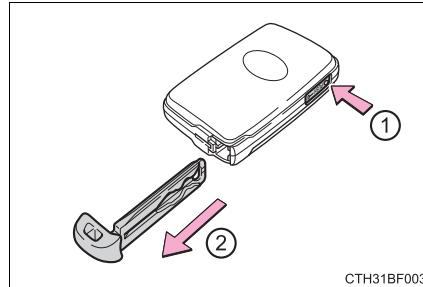

After using the mechanical key, store it in the electronic key. Carry the mechanical key together with the electronic key. If the electronic key battery is depleted or the entry function does not operate properly, you will need the mechanical key. (→P. 450)

### ■ Panic mode

#### ▶ Vehicles without a smart key system

When  is pressed for longer than about one second, an alarm will sound intermittently and the vehicle lights will flash to deter any person from trying to break into or damage your vehicle.

To stop the alarm, press any button on the wireless remote control.



#### ▶ Vehicles with a smart key system

When  is pressed for longer than about one second, an alarm will sound intermittently and the vehicle lights will flash to deter any person from trying to break into or damage your vehicle.

To stop the alarm, press any button on the electronic key.



### ■ When required to leave the vehicle's key with a parking attendant

Lock the glove box as circumstances demand. (→P. 299)

Vehicles without a smart key system: Carry the master key for your own use and provide the attendant with the valet key.

Vehicles with a smart key system: Remove the mechanical key for your own use and provide the attendant with the electronic key only.

### ■ If you lose your keys

New genuine keys can be made by your Toyota dealer using the other key (vehicles without a smart key system) or mechanical key (vehicles with a smart key system) and the key number stamped on your key number plate. Keep the plate in a safe place such as your wallet, not in the vehicle.

### ■ When riding in an aircraft

When bringing a key with wireless remote control function onto an aircraft, make sure you do not press any buttons on the key while inside the aircraft cabin. If you are carrying the key in your bag etc., ensure that the buttons are not likely to be pressed accidentally. Pressing a button may cause the key to emit radio waves that could interfere with the operation of the aircraft.

### ■ Conditions affecting operation

#### ▶ Vehicles without a smart key system

The wireless remote control function may not operate normally in the following situations:

- Near a TV tower, radio station, electric power plant, airport or other facility that generates strong radio waves
- When carrying a portable radio, cellular phone or other wireless communication devices
- When multiple wireless keys are in the vicinity
- When the wireless key is in contact with, or is covered by, a metallic object
- When a wireless key (that emits radio waves) is being used nearby
- When the wireless key has been left near an electrical appliance such as a personal computer

#### ▶ Vehicles with a smart key system

→P. 110

### ■ Key battery depletion

#### ▶ Vehicles with a smart key system

- The standard battery life is 1 to 2 years.
- If the battery becomes low, an alarm will sound in the cabin when the engine stops. (→P. 431)
- As the electronic key always receives radio waves, the battery will become depleted even if the electronic key is not used. The following symptoms indicate that the electronic key battery may be depleted. Replace the battery when necessary. (→P. 385)
  - The smart key system or the wireless remote control does not operate.
  - The detection area becomes smaller.
  - The LED indicator on the key surface does not turn on.

- To avoid serious deterioration, do not leave the electronic key within 3 ft. (1 m) of the following electrical appliances that produce a magnetic field:
  - TVs
  - Personal computers
  - Cellular phones, cordless phones and battery chargers
  - Recharging cellular phones or cordless phones
  - Table lamps
  - Induction cookers

▶ Vehicles without a smart key system

If the wireless remote control function does not operate, the battery may be depleted. Replace the battery when necessary. (→P. 385)

■ **Precautions when disconnecting the battery (vehicles with a smart key system)**

- In some cases, it may not be possible to unlock the doors using the smart key system immediately after the battery has been disconnected. Use the wireless remote control or the mechanical key to lock or unlock the doors.
- The engine may not start on the first attempt after reconnecting the battery but will start normally after the second attempt. This is not a malfunction.
- The engine switch mode is memorized by the vehicle. When the battery is reconnected, the system will return to the mode it was in before the battery was disconnected. Before disconnecting the battery, turn the engine switch off.

If you are unsure what mode the engine switch was in when the battery was disconnected, be especially careful when reconnecting the battery.

■ **Replacing the battery**

→P. 385

■ **Confirmation of the registered key number**

The number of keys already registered to the vehicle can be confirmed. Ask your Toyota dealer for details.

■ **If a wrong key is used (vehicles with a smart key system)**

The key cylinder rotates freely to isolate inside mechanism.

■ **Certification for wireless remote control**

▶ For vehicles sold in the U.S.A.

FCC ID: HYQ14ACX

FCC ID: HYQ13CZD

FCC ID: HYQ14ADF

FCC ID: HYQ13CZE

FCC ID: HYQ12BBY

FCC ID: HYQ13BDC

**NOTE:**

This device complies with part 15 of the FCC Rules. Operation is subject to the following two conditions: (1) This device may not cause harmful interference, and (2) this device must accept any interference received, including interference that may cause undesired operation.

**FCC WARNING:**

Changes or modifications not expressly approved by the party responsible for compliance could void the user's authority to operate the equipment.

► For vehicles sold in Canada

**NOTE:**

This device complies with Industry Canada licence-exempt RSS standard(s). Operation is subject to the following two conditions: (1) this device may not cause interference, and (2) this device must accept any interference, including interference that may cause undesired operation of the device.

 **NOTICE**

■ **To prevent key damage**

- Do not drop the keys, subject them to strong shocks or bend them.
- Do not expose the keys to high temperatures for long periods of time.
- Do not get the keys wet or wash them in an ultrasonic washer etc.
- Do not attach metallic or magnetic materials to the keys or place the keys close to such materials.
- Do not disassemble the keys.
- Do not attach a sticker or anything else to the surface of the electronic key and key (with a wireless remote control function).
- Vehicles with a smart key system: Do not place the keys near objects that produce magnetic fields, such as TVs, audio systems and induction cookers, or medical electrical equipment, such as low-frequency therapy equipment.

■ **Carrying the electronic key on your person (vehicles with a smart key system)**

Carry the electronic key 3.9 in. (10 cm) or more away from electric appliances that are turned on. Radio waves emitted from electric appliances within 3.9 in. (10 cm) of the electronic key may interfere with the key, causing the key to not function properly.

■ **In case of a smart key system malfunction or other key-related problems (vehicles with a smart key system)**

Take your vehicle with all the electronic keys provided with your vehicle to your Toyota dealer.

■ **When an electronic key is lost (vehicles with a smart key system)**

If the electronic key remains lost, the risk of vehicle theft increases significantly. Visit your Toyota dealer immediately with all remaining electronic keys that was provided with your vehicle.

## Side doors

### Unlocking and locking the doors from the outside

#### ◆ Smart key system (if equipped)

Carry the electronic key to enable this function.

- ① Grip the driver's door handle to unlock the door. Grip the passenger's door handle to unlock all the doors.

Make sure to touch the sensor on the back of the handle.

The doors cannot be unlocked for 3 seconds after the doors are locked.

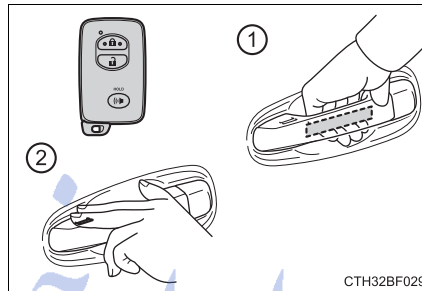

- ② Touch the lock sensor (the indentation on the upper part of the door handle) to lock the doors.

#### ◆ Wireless remote control

##### ▶ Vehicles without a smart key system

- ① Locks all the doors
- ② Unlocks all the doors

Pressing the button unlocks the driver's door. Pressing the button again within 3 seconds unlocks the other doors.

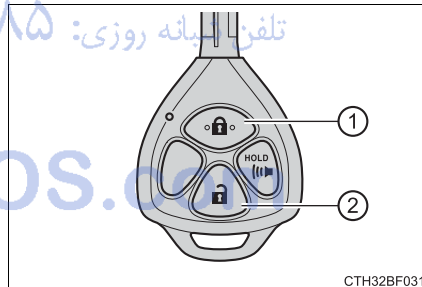

##### ▶ Vehicles with a smart key system

- ① Locks all the doors
- ② Unlocks all the doors

Pressing the button unlocks the driver's door. Pressing the button again within 3 seconds unlocks the other doors.

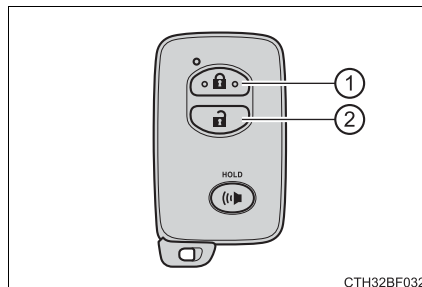



## ◆ Key

Turning the key operates the doors as follows:

### ▶ Vehicles without a smart key system

- ① Locks all the doors
- ② Unlocks all the doors

Driver's side only: Turning the key unlocks the driver's door. Turning the key again unlocks the other doors.

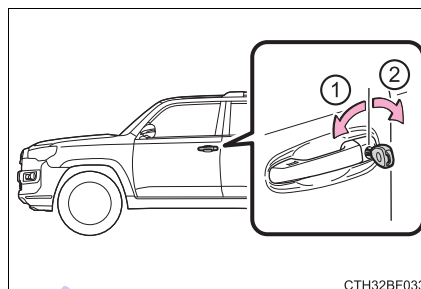

### ▶ Vehicles with a smart key system

The doors can also be locked and unlocked with the mechanical key. (→P. 450)

## ■ Operation signals

A buzzer sounds and the emergency flashers flash to indicate that the doors have been locked/unlocked. (Locked: once; Unlocked: twice)

## ■ Security feature

If a door is not opened within approximately 60 seconds after the vehicle is unlocked, the security feature automatically locks the vehicle again.

## ■ When the door cannot be locked by the lock sensor on the upper part of the door handle (vehicles with a smart key system)

If the door will not lock even when the top-side sensor area is touched, try touching both the topside and underside sensor areas at the same time.

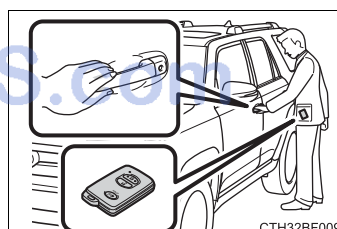

■ **Door lock buzzer**

If an attempt to lock the doors is made when a door is not fully closed, a buzzer sounds continuously. Fully close the door to stop the buzzer, and lock the vehicle once more.

■ **Alarm**

Locking the doors will set the alarm system. (→P. 72)

■ **If the smart key system or the wireless remote control does not operate properly**

Use the mechanical key to lock and unlock the doors. (→P. 450)

Replace the battery with a new one if it is depleted. (→P. 385)

**Unlocking and locking the doors from the inside**

◆ **Door lock switches**

- ① Locks all the doors
- ② Unlocks all the doors

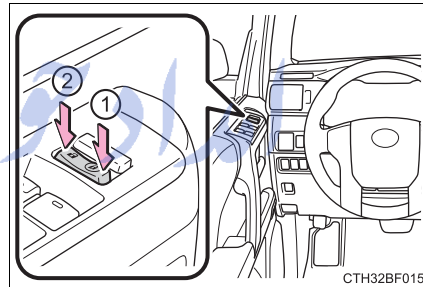

CTH32BF015

◆ **Inside lock buttons**

- ① Locks the door
- ② Unlocks the door

The front doors can be opened by pulling the inside handle even if the lock buttons are in the lock position.

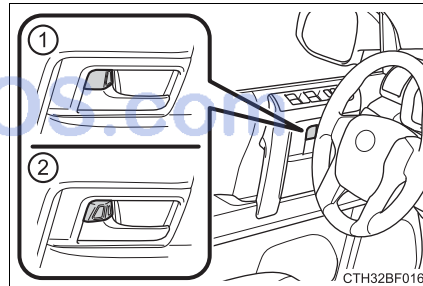

CTH32BF016

### Locking the doors from the outside without a key

- 1 Move the inside lock button to the lock position.
- 2 Close the door.

► Vehicles without a smart key system

The door cannot be locked if either of the front doors is open and the key is in the engine switch.

► Vehicles with a smart key system

The door cannot be locked if the engine switch is in ACCESSORY or IGNITION ON mode, or the electronic key is left inside the vehicle. However, the key may not be detected correctly and the door may be locked.

### Rear door child-protector lock

The door cannot be opened from inside the vehicle when the lock is set.

- 1 Unlock
- 2 Lock

These locks can be set to prevent children from opening the rear doors. Push down on each rear door switch to lock both rear doors.

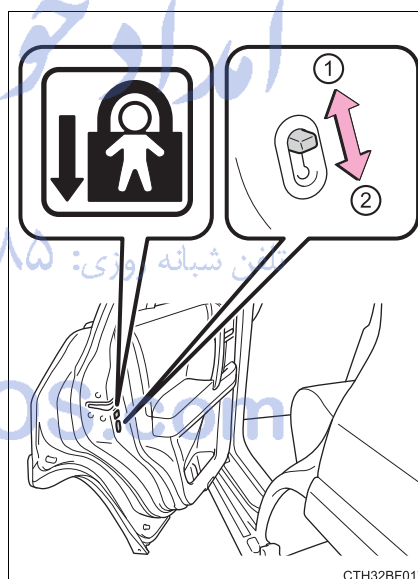

3

Operation of each component

### Automatic door locking and unlocking systems

The following functions can be set or canceled:

For instructions on customizing, refer to P. 485.



Function	Operation
Speed linked door locking function	All doors are automatically locked when vehicle speed is approximately 12 mph (20 km/h) or higher.
Shift position linked door locking function	All doors are automatically locked when shifting the shift lever to position other than P.
Shift position linked door unlocking function	All doors are automatically unlocked when shifting the shift lever to P.
Driver's door linked door unlocking function (vehicles without a smart key system)	All doors are automatically unlocked when driver's door is opened within 10 seconds after turning the engine switch to "ACC" or "LOCK".
Driver's door linked door unlocking function (vehicles with a smart key system)	All doors are automatically unlocked when driver's door is opened within 10 seconds after turning the engine switch off.

#### ■ Setting and canceling the functions: تلفن شبانه روزی

To switch between setting and canceling, follow the procedure below:

- 1 Vehicles without a smart key system: close all the doors and turn the engine switch to the "ON" position. (Perform step 2 within 20 seconds.)





Vehicles with a smart key system: close all the doors and turn the engine switch to IGNITION ON mode. (Perform step 2 within 20 seconds.)

- 2 Shift the shift lever to P or N, and press and hold the driver's door lock switch (  or  ) for approximately 5 seconds and then release.

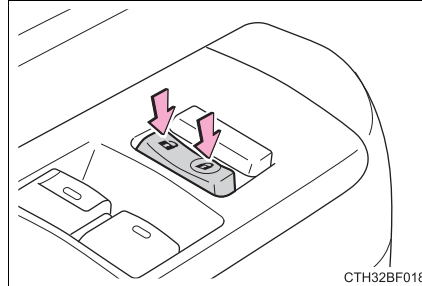
The shift lever and switch positions corresponding to the desired function to be set are shown in the following table.

Use the same procedure to cancel the function.



Function	Shift lever position	Driver's door lock switch position
Shift position linked door locking function	P	
Shift position linked door unlocking function		
Speed linked door locking function	N	
Driver's door linked door unlocking function		

When the setting or canceling operation is complete, all the doors are locked and then unlocked.

#### ■ Customization

Settings (e.g. unlocking function using a key) can be changed.  
(Customizable features: →P. 485)

3

Operation of each component

 CAUTION**■ To prevent an accident**

Observe the following precautions while driving the vehicle.

Failure to do so may result in a door opening and an occupant throwing out of the vehicle, resulting in death or serious injury.

- Ensure that all doors are properly closed and locked.
- Do not pull the inside handle of the doors while driving.  
Be especially careful for the front doors, as the doors may be opened even if the inside lock buttons are in locked position.
- Set the rear door child-protector locks when children are seated in the rear seats.

امداد خودرو فارما

تلفن شبانه روزی: ۰۲۱-۸۸۸۶۲۰۸۵

FarmaSOS.com

## Smart key system\*

### Function summary

The following operations can be performed simply by carrying the electronic key on your person, for example in your pocket. (The driver should always carry the electronic key.)

- Locks and unlocks the doors (→P. 100)
- Starts the engine (→P. 195)

#### ■ Antenna location

- ① Antennas outside the cabin
- ② Antennas inside the cabin
- ③ Antenna outside the luggage compartment

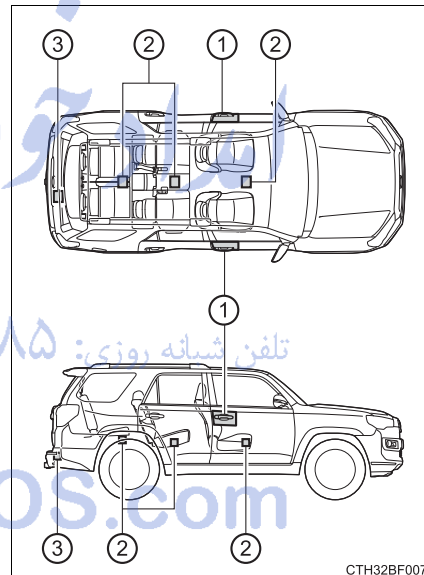

3

Operation of each component

\*: If equipped

**■ Effective range (areas within which the electronic key is detected)**

- When locking or unlocking the doors

The system can be operated when the electronic key is within about 2.3 ft. (0.7 m) either of the outside front door handles and back door. (Only the doors detecting the key can be operated.)

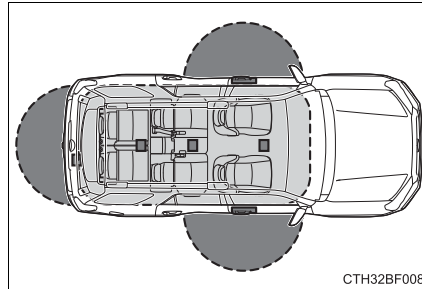

- When starting the engine or changing engine switch modes

The system can be operated when the electronic key is inside the vehicle.

تلفن شبانه روزی: ۰۲۱-۸۸۸۶۲۰۸۵

FarmaSOS.com



### ■ Alarms and warning indicators

A combination of exterior and interior alarms as well as warning messages shown on the multi-information display are used to prevent theft of the vehicle and accidents resulting from erroneous operation. Take appropriate measures in response to any warning message on the multi-information display. (→P. 426)

The following table describes circumstances and correction procedures when only alarms are sounded.

Alarm	Situation	Correction procedure
Exterior alarm sounds once for 5 seconds	An attempt was made to lock the doors using the smart key system while the electronic key was still inside the vehicle.	Retrieve the electronic key from the vehicle and lock the doors again.
	An attempt was made to lock either front door by opening a door and putting the inside lock button into the lock position, then closing the door by pulling on the outside door handle with the electronic key still inside the vehicle.	
	An attempt was made to lock the vehicle while a door was open.	Close all of the doors and lock the doors again.
Interior alarm sounds continuously	An attempt was made to open the door and exit the vehicle when the shift lever was not in P.	Shift the shift lever to P.
Interior alarm pings repeatedly	The engine switch was turned to ACCESSORY mode while the driver's door was open (The driver's door was opened when the engine switch was in ACCESSORY mode.)	Turn the engine switch off and close the driver's door.

Alarm	Situation	Correction procedure
Interior alarm sounds once.	The engine switch was pressed after the doors were unlocked with the mechanical key.	Touch the electronic key to the engine switch while depressing the brake pedal.
	The engine switch was pressed two consecutive times without the electronic key being present.	

#### ■ Battery-saving function

The battery-saving function will be activated in order to prevent the electronic key battery and the vehicle battery from being discharged while the vehicle is not in operation for a long time.

- In the following situations, the smart key system may take some time to unlock the doors.
  - The electronic key has been left in an area of approximately 6 ft. (2 m) of the outside of the vehicle for 10 minutes or longer.
  - The smart key system has not been used for 5 days or longer.
- If the smart key system has not been used for 14 days or longer, the doors cannot be unlocked at any doors except the driver's door. In this case, take hold of the driver's door handle, or use the wireless remote control or the mechanical key, to unlock the doors.

The system will resume operation when

- The vehicle is locked using the door handle lock switch when carrying the electronic key on your person.
- The vehicle is locked/unlocked using the wireless remote control. (→P. 100)
- The vehicle is locked/unlocked using the mechanical key. (→P. 450)

#### ■ Conditions affecting operation

The smart key system uses weak radio waves. In the following situations, the communication between the electronic key and the vehicle may be affected, preventing the smart key system, wireless remote control and engine immobilizer system from operating properly. (Ways of coping: →P. 450)

- When the electronic key battery is depleted
- Near a TV tower, electric power plant, gas station, radio station, large display, airport or other facility that generates strong radio waves or electrical noise
- When carrying a portable radio, cellular phone, cordless phone or other wireless communication device

- When the electronic key is in contact with, or is covered by the following metallic objects
    - Cards to which aluminum foil is attached
    - Cigarette boxes that have aluminum foil inside
    - Metallic wallets or bags
    - Coins
    - Hand warmers made of metal
    - Media such as CDs and DVDs
  - When multiple electronic keys are in the vicinity
  - When other wireless keys (that emit radio waves) are being used nearby
  - When carrying the electronic key together with the following devices that emit radio waves
    - Another vehicle's electronic key or a wireless key that emits radio waves
    - Personal computers or personal digital assistants (PDAs)
    - Digital audio players
    - Portable game systems
  - If window tint with a metallic content or metallic objects are attached to the back window
- **Note for the entry function**
- Even when the electronic key is within the effective range (detection areas), the system may not operate properly in the following cases:
    - The electronic key is too close to the window or outside door handle, near the ground, or in a high place when the doors are locked or unlocked.
    - The electronic key is on the instrument panel or floor, in the glove box, or in the auxiliary box of the instrument panel.
  - Do not leave the electronic key on top of the instrument panel or near the door pockets when exiting the vehicle. Depending on the radio wave reception conditions, it may be detected by the antenna outside the cabin and the door will become lockable from the outside, possibly trapping the electronic key inside the vehicle.
  - As long as the electronic key is within the effective range, the doors may be locked or unlocked by anyone. However, only the doors detecting the electronic key can be used to unlock the vehicle.
  - The doors may lock or unlock if the electronic key is within the effective range and a large amount of water splashes on the door handle, such as in the rain or in a car wash. The doors will automatically be locked after approximately 60 seconds if a door is not opened and closed.
  - If the wireless remote control is used to lock the doors when the electronic key is near the vehicle, there is a possibility that the door may not be unlocked by the entry function. (Use the wireless remote control to unlock the doors.)

**■ Note for locking the doors**

- Touching the door lock sensor while wearing gloves may delay or prevent lock operation. Remove the gloves and touch the lock sensor again.
- When the lock operation is performed using the lock sensor, recognition signals will be shown up to two consecutive times. After this, no recognition signals will be given.
- If the door handle becomes wet while the electronic key is within the effective range, the door may lock and unlock repeatedly. Place the electronic key in a location 6 ft. (2 m) or more away from the vehicle while the vehicle is being washed. (Take care to ensure that the key is not stolen.)
- If the electronic key is inside the vehicle and a door handle becomes wet during a car wash, a buzzer will sound outside the vehicle. To turn off the alarm, lock all the doors.
- The lock sensor may not work properly if it comes into contact with ice, snow, mud, etc. Clean the lock sensor and attempt to operate it again, or use the lock sensor on the lower part of the door handle.
- Fingernails may scrape against the door during operation of the door handle. Be careful not to injure fingernails or damage the surface of the door.

**■ Note for the unlocking function**

- Gripping the door handle when wearing a glove may not unlock the door.
- A sudden approach to the effective range or door handle may prevent the doors from being unlocked. In this case, return the door handle to the original position and check that the doors unlock before pulling the door handle again.
- If there is another electronic key in the detection area, it may take slightly longer to unlock the doors after the door handle is gripped.

**■ When the vehicle is not driven for extended periods**

To prevent theft of the vehicle, do not leave the electronic key within 6 ft. (2 m) of the vehicle.

**■ To operate the system properly**

- Make sure to carry the electronic key when operating the system. Do not get the electronic key too close to the vehicle when operating the system from the outside of the vehicle.
- Depending on the position and holding condition of the electronic key, the key may not be detected correctly and the system may not operate properly. (The alarm may go off accidentally, or the door lock prevention function may not operate.)

**■ If the smart key system does not operate properly**

- Locking and unlocking the doors: Use the mechanical key. (→P. 450)
- Starting the engine: →P. 450

**■ Customization**

Settings (e. g. operation signal) can be changed.  
(Customizable features: →P. 485)

■ **If the smart key system has been deactivated in a customized setting**

- Locking and unlocking the doors: →P. 450
- Starting the engine and changing engine switch modes: →P. 450
- Stopping the engine: →P. 196

■ **Certification for the smart key system**

- ▶ For vehicles sold in the U.S.A.

FCC ID: NI4TMIMB-1

FCC ID: NI4TMLF8-14

FCC ID: HYQ14ACX

FCC ID: HYQ13CZD

FCC ID: HYQ14ADF

FCC ID: HYQ13CZE

NOTE:

This device complies with part 15 of the FCC Rules. Operation is subject to the following two conditions: (1) This device may not cause harmful interference, and (2) this device must accept any interference received, including interference that may cause undesired operation.

FCC WARNING:

Changes or modifications not expressly approved by the party responsible for compliance could void the user's authority to operate the equipment.

- ▶ For vehicles sold in Canada

NOTE:

This device complies with Industry Canada licence-exempt RSS standard(s). Operation is subject to the following two conditions: (1) this device may not cause interference, and (2) this device must accept any interference, including interference that may cause undesired operation of the device.

 **CAUTION**

■ **Caution regarding interference with electronic devices**

- People with implanted pacemakers or cardiac defibrillators should keep away from the smart key system antennas.  
(→P. 107)

The radio waves may affect the operation of such devices. If necessary, the entry function can be disabled. Ask your Toyota dealer for details, such as the frequency of radio waves and timing of emitting the radio waves. Then, consult your doctor to see if you should disable the entry function.

- Users of any electrical medical device other than implanted pacemakers and implanted cardiac defibrillators should consult the manufacturer of the device for information about its operation under the influence of radio waves.

Radio waves could have unexpected effects on the operation of such medical devices.

Ask your Toyota dealer for details on disabling the entry function.

## Automatic running boards\*

The Automatic running boards are linked to the side door operations, extending and retracting when a side door is opened and closed. When a door is opened or closed, the board on the same side extends or retracts.

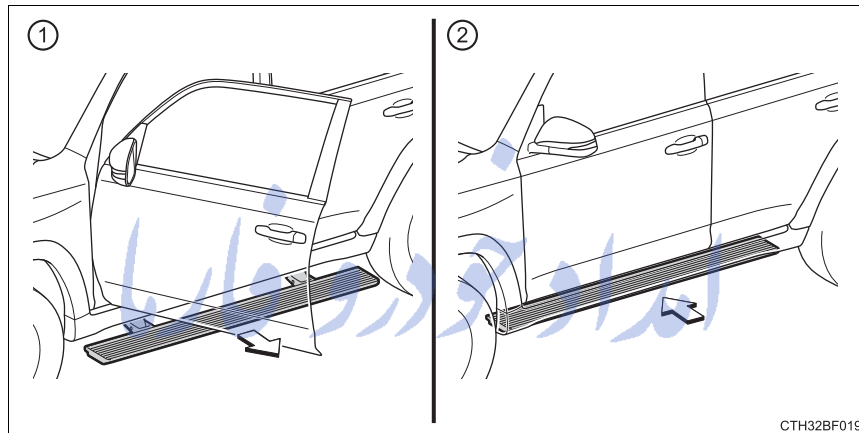

- ① Opening a door: The appropriate board extends
- ② Closing a door: The appropriate board retracts

### Turning off the Automatic running boards system

Press "OFF" on the Automatic running boards switch to turn off the Automatic running boards system.

- ① On (Automatic mode)
- ② Off

The orange line at the top of the switch illuminates to indicate that the Automatic running boards system is on.

When extension of the boards is not necessary, or extension of a board is not desirable due to an obstacle, turn the Automatic running boards switch off before opening the side door.

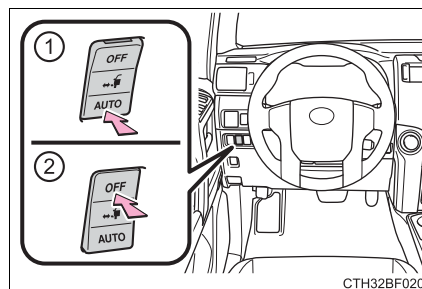

\*: If equipped

**■ Jam protection function**

During Automatic running boards operation:

If a board contacts an obstacle when extending, it will retract. If an obstacle gets caught between a board and the vehicle when retracting, the board will extend.

If an obstacle is detected 3 times in a row during Automatic running boards operation, the board will stop at the position it contacts the obstacle. When a side door on the same side as the board is opened and closed one more time, the board will extend and retract, or retract and extend. After this, the board will resume normal operation.

**■ Automatic retraction function**

The boards will be automatically retracted, for safety, under the following conditions:

- A board is not completely retracted
- Vehicle speed is approximately 5 mph (8 km/h) or higher

The boards will not automatically extend again when vehicle speed returns to less than 5 mph (8 km/h).

**■ If the Automatic running boards indicator comes on when driving first commences**

A board has not completely retracted. Check that no obstacles are caught between a board and the vehicle.

**■ If the Automatic running boards indicator light flashes**

There may be a malfunction in the Automatic running boards system. Have the vehicle inspected by your Toyota dealer immediately.

**■ When snow or mud is attached to the board or the board is frozen**

The Automatic running boards may not operate correctly. Before stepping on a board, check that it is completely extended. If the Automatic running boards are not operating correctly, turn the Automatic running boards switch off and refrain from use.

When removing snow or mud, turn the Automatic running boards switch off.

**■ After recharging/reconnecting the battery**

If the Automatic running boards have not completely extended or retracted, the boards may not move in the intended direction the first time they are operated. However, from the second time onwards, the boards will resume normal operation.

**■ When getting in and out of the vehicle**

Take care because clothes and shoes may become dirty due to contact with the lower part of the vehicle body.

 CAUTION**■ Jam protection function**

Observe the following precautions.

Failure to do so may cause serious injury.

Never use any part of your body to intentionally activate the jam protection function.

The jam protection function may not work depending on the shape of the object that is caught. Be careful not to get fingers or other body parts caught.

**■ Cautions regarding the Automatic running boards**

Observe the following precautions.

Failure to do so may cause serious injury.

- Check to make sure that all passengers and people in the vehicle's surrounding area do not have a hand on a board or any part of their body in a position where it could be caught between a board and the vehicle when an Automatic running board is being operated.
- Confirm that the boards have completely extended or retracted before getting in or out of the vehicle. If someone gets in or out of the vehicle during Automatic running board operation, the boards may stop extending or retracting.
- Drive the vehicle after confirming that the boards have completely retracted. Driving with a board extended is dangerous because it may hit other people or objects.
- Take care when pressing the Automatic running boards switch. The board will extend or retract and may hit other people or objects.
- Always check that the Automatic running boards switch is turned off when cleaning a board.
- Do not allow children to operate the Automatic running boards. Operating Automatic running boards in a manner so that a board contacts someone can cause serious injury, and in some instances, even death.



## Back door

### Unlocking and locking the back door from the outside

#### ◆ Smart key system (if equipped)

Carry the electronic key to enable this function.

- ① Press the button to unlock the door.
- ② Press the button to lock the door.

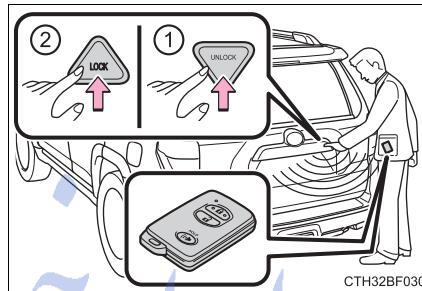

#### ◆ Wireless remote control

→P. 100

#### ◆ Key (vehicles without a smart key system)

Turning the key operates the doors as follows:

- ① Locks all the doors
- ② Unlocks all the doors

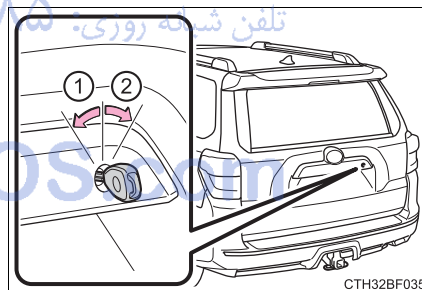

### Unlocking and locking the back door from the inside

- ① Locks all the doors
- ② Unlocks all the doors

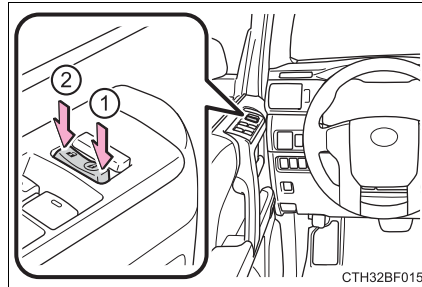

### Opening the back door from outside the vehicle

Raise the back door while pushing up the back door opener switch.

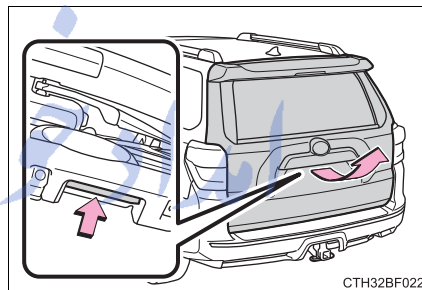

### Rear step bumper

The rear step bumper is intended for rear end protection and easier step-up loading.

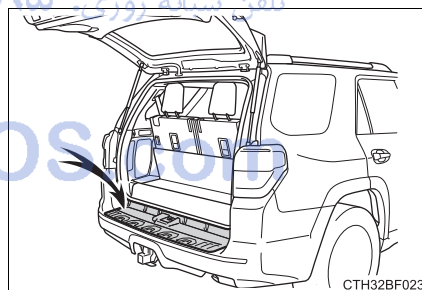

### When closing the back door

Lower the back door using the back door strap and/or the back door handle, and make sure to push the back door down from the outside to close it.

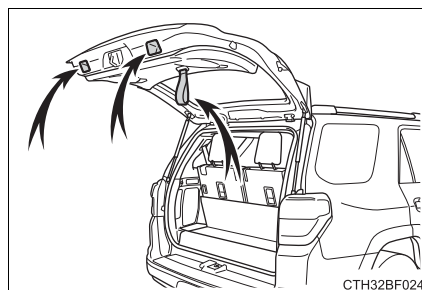

### ■ Luggage compartment lights

Each luggage compartment light has the following 3 positions:

- ① Turns the light off
- ② Turns the light on
- ③ Turns the light on/off linked to back door position

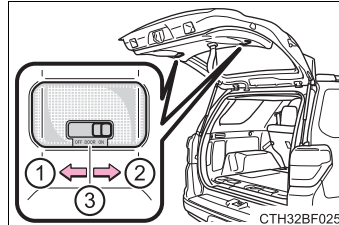

If the luggage compartment lights remain on, the lights will go off automatically after 20 minutes.

### ■ If the back door opener is inoperative or the battery is discharged

→P. 449

#### ⚠ CAUTION

##### ■ Before driving

Observe the following precautions.

Failure to do so may result in death or serious injury.

- Make sure that the back door is fully closed. If the back door is not fully closed, it may open unexpectedly while driving and hit near-by objects or luggage in the luggage compartment may be thrown out, causing an accident.
- Do not allow children to play in the luggage compartment.  
If a child is accidentally locked in the luggage compartment, they could have heat exhaustion or other injuries.
- Do not allow a child to open or close the back door.  
Doing so may cause the back door to move unexpectedly, or cause the child's hands, head, or neck to be caught by the closing back door.
- Do not get on the rear step bumper.

##### ■ Important points while driving

Never let anyone sit in the luggage compartment. In the event of sudden braking or a collision, they are susceptible to death or serious injury.

**⚠ CAUTION**

**■ Operating the back door**

Observe the following precautions.

Failure to do so may cause parts of the body to be caught, resulting in death or serious injury.

- Remove any heavy loads, such as snow and ice, from the back door before opening it. Failure to do so may cause the back door to suddenly shut again after it is opened.
- When opening or closing the back door, thoroughly check to make sure the surrounding area is safe.
- If anyone is in the vicinity, make sure they are safe and let them know that the back door is about to open or close.
- Use caution when opening or closing the back door in windy weather as it may move abruptly in strong wind.

- The back door may suddenly shut if it is not opened fully. It is more difficult to open or close the back door on an incline than on a level surface, so beware of the back door unexpectedly opening or closing by itself. Make sure that the back door is fully open and secure before using the luggage compartment.

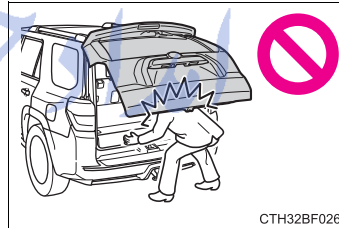

- When closing the back door, take extra care to prevent your fingers etc. from being caught.

- When closing the back door, make sure to press it lightly on its outer surface. If the back door handle or back door strap is used to fully close the back door, it may result in hands or arms being caught.

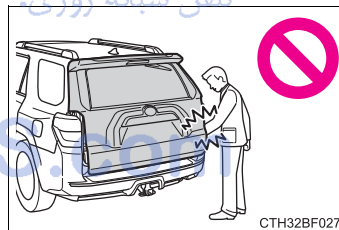

**⚠ CAUTION**

- Do not pull on the back door damper stay to close the back door, and do not hang on the back door damper stay. Doing so may cause hands to be caught or the back door damper stay to break, causing an accident.
- If a bicycle carrier or similar heavy object is attached to the back door, it may suddenly shut again after being opened, causing someone's hands, head or neck to be caught and injured. When installing an accessory part to the back door, using a genuine Toyota part is recommended.

**⚠ NOTICE**

■ **To prevent damage to the back door components**

Do not allow more than one person to get on the rear step bumper at a time.

■ **Back door damper stays**

The back door is equipped with damper stays that hold the back door in place.

Observe the following precautions.

Failure to do so may cause damage to the back door damper stay, resulting in malfunction.

- Do not attach any foreign objects, such as stickers, plastic sheets, or adhesives to the damper stay rod.
- Do not touch the damper stay rod with gloves or other fabric items.
- Do not attach any accessories other than genuine Toyota parts to the back door.
- Do not place your hand on the damper stay or apply lateral forces to it.

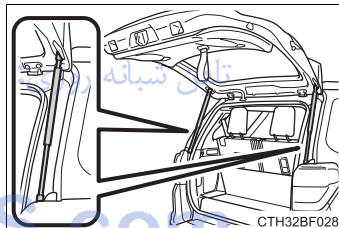

امداد خودرو فارما

تلفن شبانه روزی: ۰۲۱-۸۸۸۶۲۰۸۵

**FarmaSOS.com**

امداد خودرو فارما

تلفن شبانه روزی: ۰۲۱-۸۸۸۶۲۰۸۵

FarmaSOS.com

3

Operation of each component

## Front seats

### Adjustment procedure

#### ► Power seat

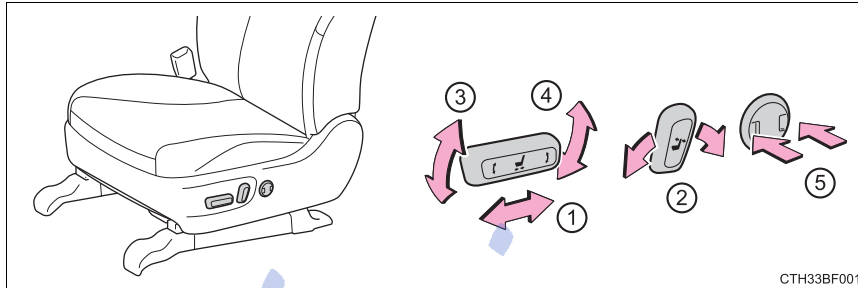

- ① Seat position adjustment switch
- ② Seatback angle adjustment switch
- ③ Seat cushion (front) angle adjustment switch (driver's side only)
- ④ Vertical height adjustment switch (driver's side only)
- ⑤ Lumbar support adjustment switch (driver's side only)

#### ► Manual seat

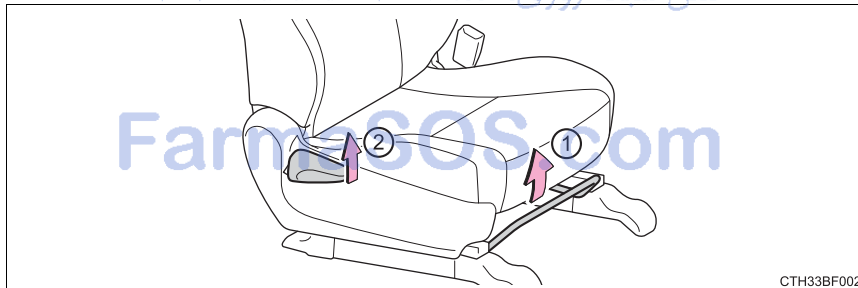

- ① Seat position adjustment lever
- ② Seatback angle adjustment lever



### Active head restraints

When the occupant's lower back presses against the seatback during a rear-end collision, the head restraint moves slightly forward and upward to help reduce the risk of whiplash to the seat occupant.

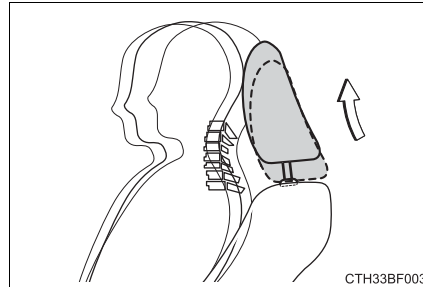

### ■ The auto away function for exiting the driver seat

If the seat is already close to the rearmost position, the auto away function may not operate when the driver exits the vehicle.

### ■ Active head restraints

Even small forces applied to the seatback may cause the head restraint to move. Pushing up a locked head restraint forcibly may appear the head restraint inner structure. These do not indicate problems.

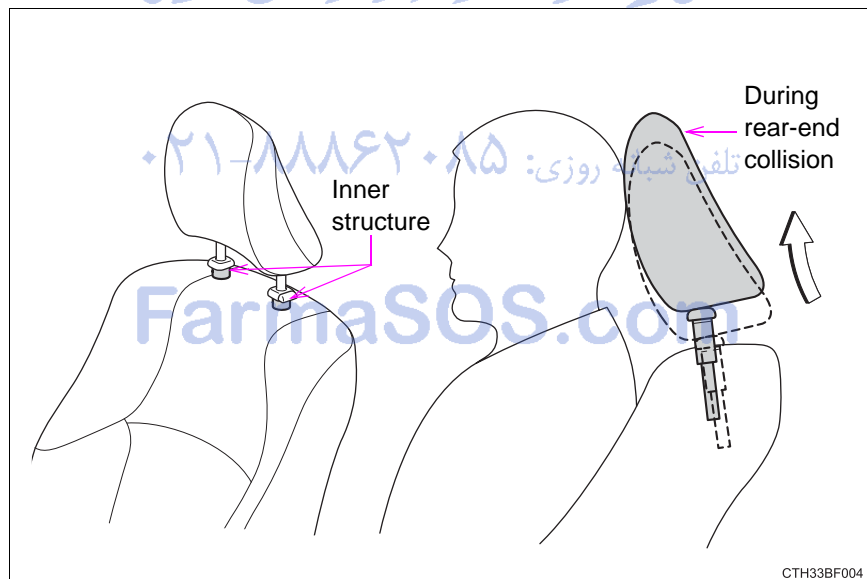

**⚠ CAUTION****■ When adjusting the seat position**

- Take care when adjusting the seat position to ensure that other passengers are not injured by the moving seat.
- Do not put your hands under the seat or near the moving parts to avoid injury.  
Fingers or hands may become jammed in the seat mechanism.

**■ Seat adjustment**

- To reduce the risk of sliding under the lap belt during a collision, do not recline the seat more than necessary.  
If the seat is too reclined, the lap belt may slide past the hips and apply restraint forces directly to the abdomen, or your neck may contact the shoulder belt, increasing the risk of death or serious injury in the event of an accident.  
Adjustments should not be made while driving as the seat may unexpectedly move and cause the driver to lose control of the vehicle.
- After adjusting the seat, make sure that the seat is locked in position. (manual seat only)

**■ When adjusting the seat positions**

Make sure to leave enough space around the feet so they do not get stuck.

تلفن شبانه روزی: ۰۲۱-۸۸۸۶۲۰۸۵

FarmaSOS.com

## Rear seats

### Adjustment procedures

- ▶ Vehicles without third row seats

#### ■ Rear seat

Pull up the seatback angle adjustment lever until the lock is released.

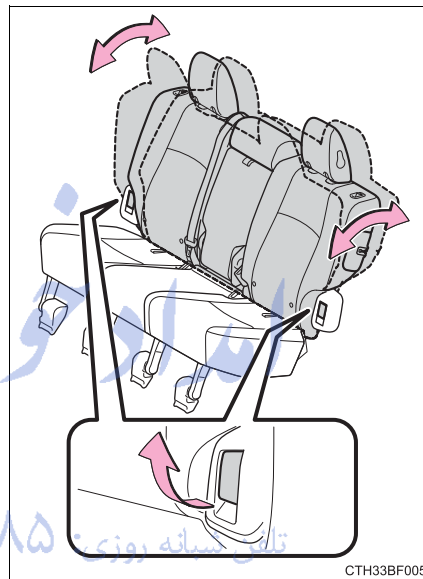

3

Operation of each component

FarmaSOS.com

► Vehicles with third row seats

■ **Second row seats**

- ① Seat position adjustment lever
- ② Seatback angle adjustment lever

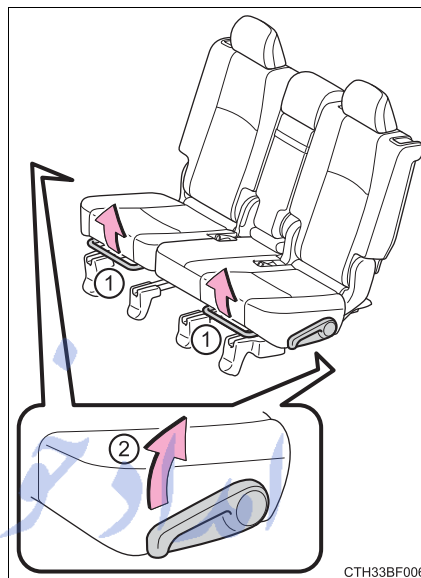

■ **Third row seats**

The third row seats do not have a seat adjustment function.

تلفن شبانه روزی: ۰۲۱-۸۸۸۶۲۰۸۵

FarmaSOS.com

### Folding down the rear seats (vehicles without third row seats)

#### ■ Before folding down the rear seats

- 1 Adjust the head restraints to the downmost position.

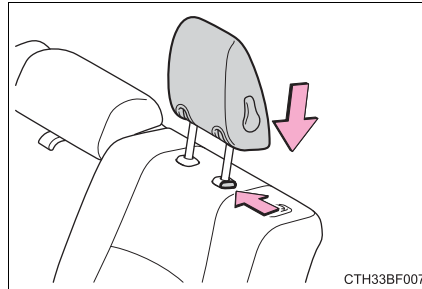

- 2 Fold down the head restraints.

When returning the head restraints to their original positions, make sure they are locked securely.

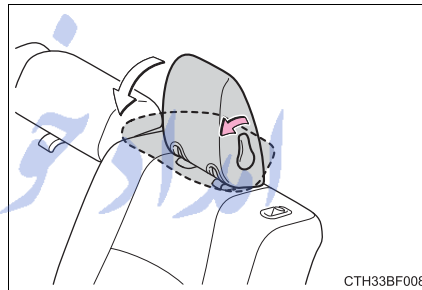

- 3 Stow the rear seat belt buckles.

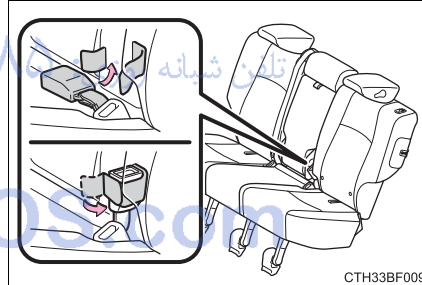

3

Operation of each component

### ■ Folding down the rear seats

- 1 Swing the bottom cushions up by pulling the lock release strap.

When returning the rear seat cushions to their original positions, make sure they are locked securely.

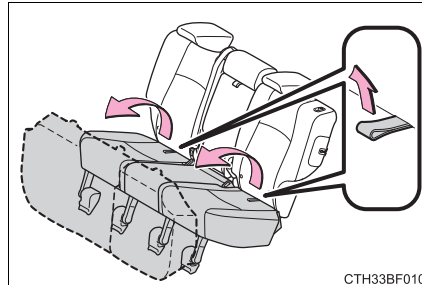

- 2 Push the lock release button and fold down the seatbacks.

To return the rear seatbacks to their original positions, lift them up until they lock.

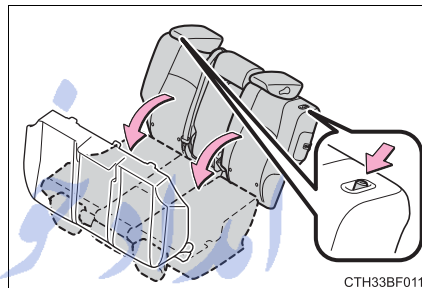

### ■ Folding down rear center seatback only

Pull the center seatback angle lever behind the seatback and fold the seatback down.

To return the rear center seatback to its original position, lift it up until it locks.

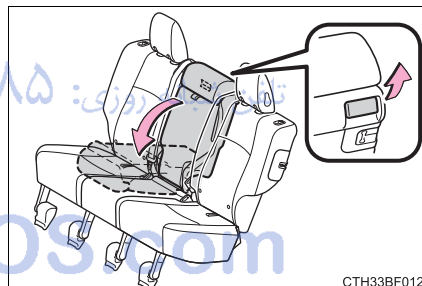

### Folding down the second row seats (vehicles with third row seats)

#### ■ Before folding down the second row seats

- 1 Adjust the head restraints to the downmost position.

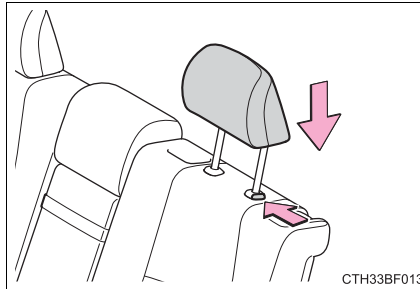

- 2 Stow the second row seat belt buckles.

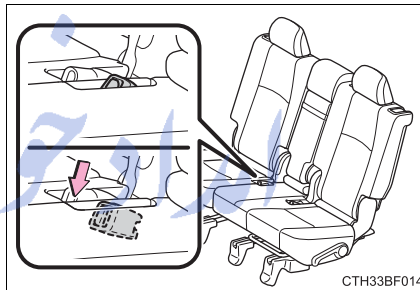

#### ■ Folding down the second row seats

Pull the seatback lock release lever and fold the seatback down.

To return the second row seatbacks to their original positions, lift them up until they lock.

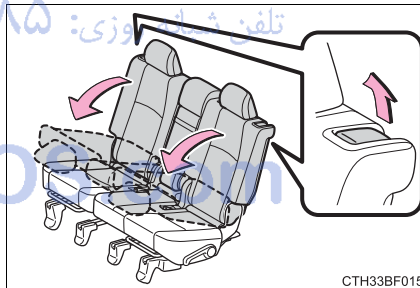

#### ■ Folding down the second row center seatback only

Pull the center seatback angle lever behind the seatback and fold the seatback down.

To return the second row center seatback to its original position, lift it up until it locks.

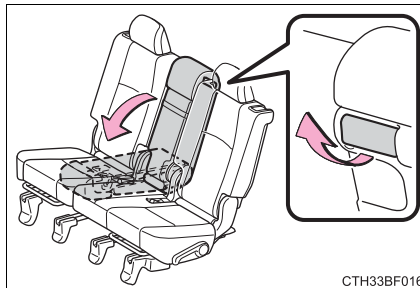

3

Operation of each component

**Moving a second row seat for access to the third row seats (vehicles with third row seats)****■ Getting in the vehicle (right side only)**

Pull up the lever and fold down the seatback. The seat will slide forward.

Move the seat to the front-most position.

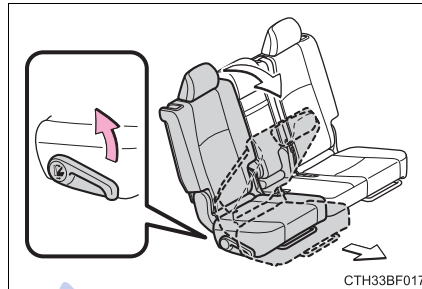
**■ Getting out of the vehicle (right side only)**

Lift the lever on the back of the seatback and fold down the seatback. The seat will slide forward.

Move the seat to the front-most position.

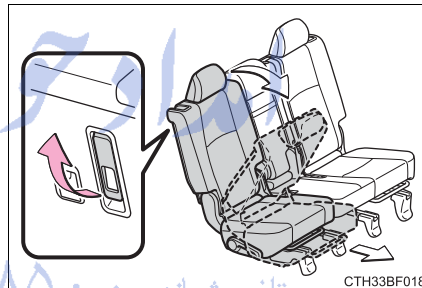
**■ After passengers have entered/exited the vehicle**

Lift up the seatback and slide the seat backward until it locks.

FarmaSOS.com



### Folding down the third row seats (vehicles with third row seats)

#### ■ Before folding down the third row seats

Pass the seat belts through the seat belt hangers and secure the seat belt plates.

This prevents the shoulder belts from being damaged.

Make sure that the seat belts are removed from the hangers before using them.

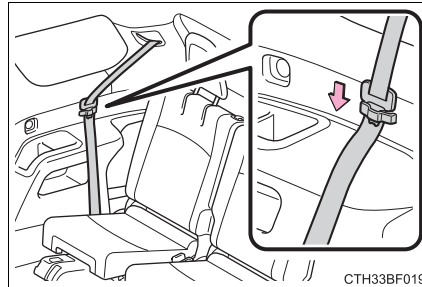

#### ■ Folding down the third row seats

##### ► From inside

- 1 Pull the strap to fold down the head restraint.

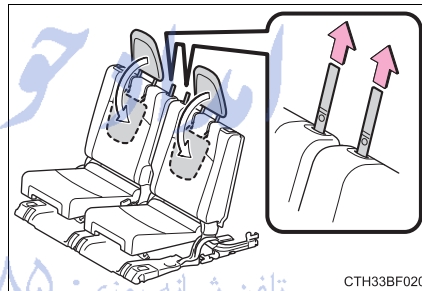

- 2 Pull the lever up. The seat cushion will slide backward.

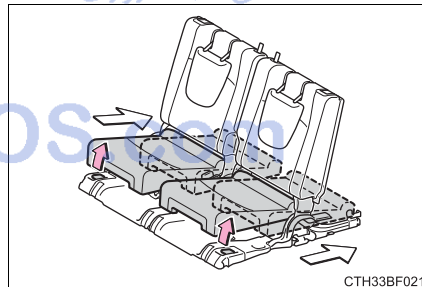

- 3 Pull the lever to unlock the seatback and then fold the seatback down.

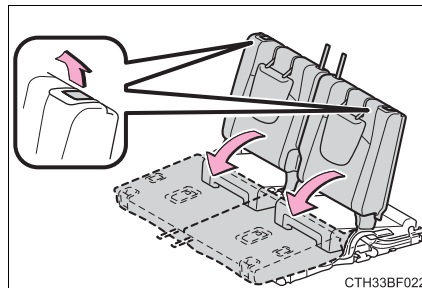

► From outside

- 1 Pull the strap to fold down the head restraint.

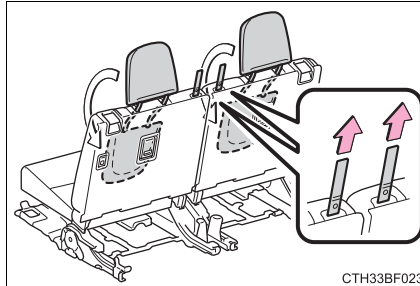

- 2 Pull the lever up.  
The seat cushion will slide backward and the seatback will be unlocked.

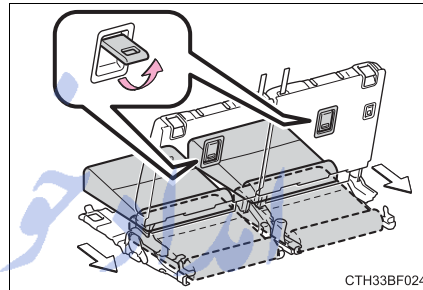

- 3 Fold the seatback down.

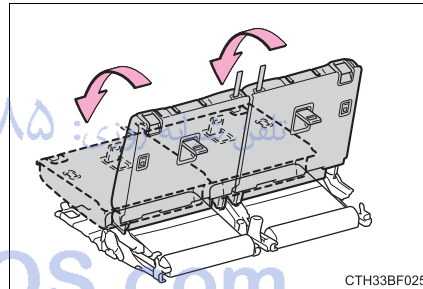

### ■ Returning the third row seats

As the seat cushions cannot be pulled forward from outside, this operation can only be performed from inside.

- 1 Raise the seatbacks to their original positions.

Make sure they are locked securely.

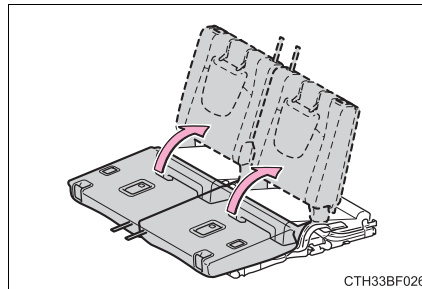

- 2 Pull the seat cushions forward.

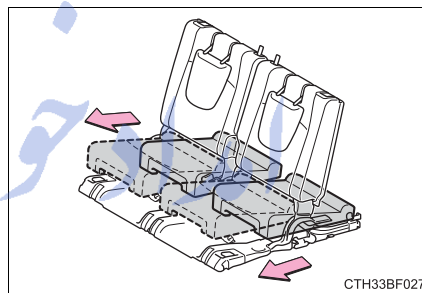

- 3 Raise the head restraints.

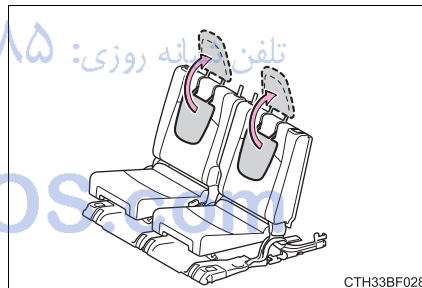

3

Operation of each component

 CAUTION**■ When folding the rear seatbacks down**

Observe the following precautions. Failure to do so may result in death or serious injury.

- Do not fold the seatbacks down while driving.
- Stop the vehicle on level ground, set the parking brake and shift the shift lever to P.
- Do not allow anyone to sit on a folded seatback or in the luggage compartment while driving.
- Do not allow children to enter the luggage compartment.

**■ Seat adjustment**

● To reduce the risk of sliding under the lap belt during a collision, do not recline the seat more than necessary.

If the seat is too reclined, the lap belt may slide past the hips and apply restraint forces directly to the abdomen, or your neck may contact the shoulder belt, increasing the risk of death or serious injury in the event of an accident.

Adjustments should not be made while driving as the seat may unexpectedly move and cause the driver to lose control of the vehicle.

- Take care when adjusting the seat position to ensure that other passengers are not injured by the moving seat.
- Do not put your hands under the seat or near the moving parts to avoid injury.  
Fingers or hands may become jammed in the seat mechanism.

**■ After returning the rear seatback to the upright position**

Observe the following precautions. Failure to do so may result in death or serious injury.

- Make sure the seatback is securely locked by pushing it forward and rearward on the top.
- Check that the seat belts are not twisted or caught in the seatback.

 NOTICE**■ Stowing the seat belts**

The seat belts and the buckles must be stowed before you fold down the rear seatbacks.

## Driving position memory\*

This feature automatically adjusts the driver's seat to suit your preferences.

### Driving position memory

Your preferred driving position (the position of the driver's seat) can be recorded and recalled by pressing a button.

Two different driving positions can be recorded into memory.

#### ■ Recording procedure

- 1 Check that the shift lever is in P.
- 2 Turn the engine switch to IGNITION ON mode.
- 3 Adjust the driver's seat to the desired positions.
- 4 While pressing the "SET" button, or within 3 seconds after the "SET" button is pressed, press button "1" or "2" until the buzzer sounds.

If the selected button has already been preset, the previously recorded position will be overwritten.

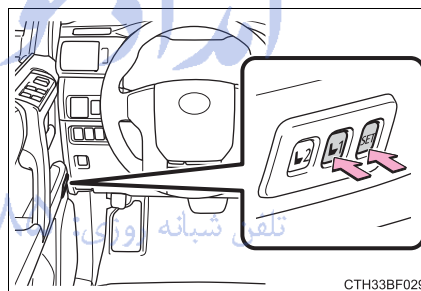

#### ■ Recall procedure

- 1 Check that the shift lever is in P.
- 2 Turn the engine switch to IGNITION ON mode.
- 3 Press one of the buttons for the driving position you want to recall until the buzzer sounds.

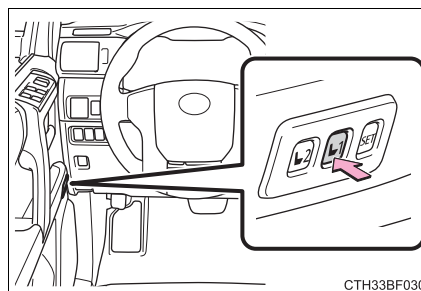

3

Operation of each component

\*: If equipped

**■ To stop the position recall operation part-way through**

Perform any of the following:

- Press the "SET" button.
- Press button "1" or "2".
- Operate any of the seat adjustment switches (only cancels seat position recall).

**■ Seat positions that can be memorized (→P. 122)**

All adjusted positions can be recorded.

**■ Operating the driving position memory after turning the engine switch off**

Recorded seat positions can be activated up to 180 seconds after the driver's door is opened and another 60 seconds after it is closed again.

**■ In order to correctly use the driving position memory function**

If a seat position is already in the furthest possible position and the seat is operated in the same direction, the recorded position may be slightly different when it is recalled.

**Memory recall function**

Each electronic key can be registered to recall your preferred driving position.

**■ Registering procedure**

Record your driving position to button "1" or "2" before performing the following:

Carry only the key you want to register, and then close the driver's door.

If 2 or more keys are in the vehicle, the driving position cannot be recorded properly.

- 1 Check that the shift lever is in P.
- 2 Turn the engine switch to IGNITION ON mode.
- 3 Recall the driving position that you want to record.

- 4 While pressing the recalled button, press and hold the door lock switch (either lock or unlock) until the buzzer sounds.

If the button could not be registered, the buzzer sounds continuously for approximately 3 seconds.

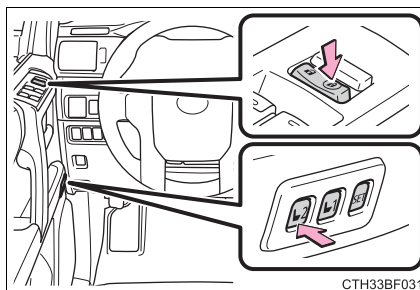

#### ■ Recall procedure

Carry the electronic key that has been registered to the driving position, and then unlock and open the driver's door using the smart system or wireless remote control.

The driving position will move to the recorded position.

If the driving position is in a position that has already been recorded, the seat will not move.

#### ■ Cancellation procedure

Carry only the key you want to cancel and then close the driver's door.

If 2 or more keys are in the vehicle, the driving position cannot be canceled properly.

- 1 Turn the engine switch to IGNITION ON mode.
- 2 While pressing the "SET" button, press and hold the door lock switch (either lock or unlock) until the buzzer sounds twice.

If the button could not be canceled, the buzzer sounds continuously for approximately 3 seconds.

#### ■ Recalling the driving position using the memory recall function

- Different driving positions can be registered for each electronic key. Therefore, the driving position that is recalled may be different depending on the key being carried.
- If a door other than the driver's door is unlocked with the smart system, the driving position cannot be recalled. In this case, press the driving position button which has been set.

#### ■ Customization

The unlock door settings of the memory recall function can be customized. (Customizable features: →P. 485)

 CAUTION■ **Seat adjustment caution**

Take care during seat adjustment so that the seat does not strike the rear passenger or squeeze your body against the steering wheel.

امداد خودرو فارما

تلفن شبانه روزی: ۰۲۱-۸۸۸۶۲۰۸۵

FarmaSOS.com



## Head restraints

Head restraints are provided for all seats.

### Front seats

Vertical adjustment

- ① Up  
Pull the head restraints up.
- ② Down  
Push the head restraint down while pressing the lock release button.

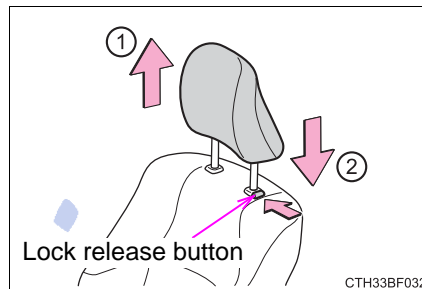

### Second seats

Vertical adjustment

- ① Up  
Pull the head restraints up.
- ② Down  
Push the head restraint down while pressing the lock release button.

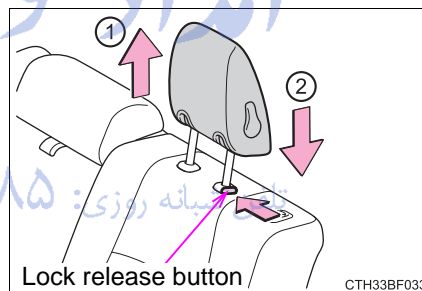

Folding the head restraints (vehicle without third row seats)

- ① To use  
Lift up the head restraint until it locks.
- ② To fold  
Pull the head restraint lock release lever to fold the head restraint.

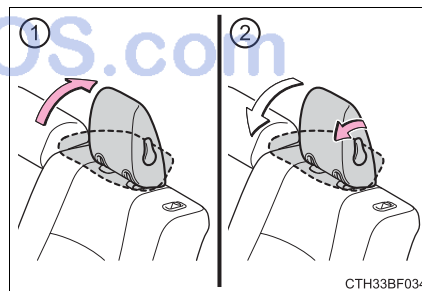

3

Operation of each component

**Third seats (vehicle with third row seats)**

- ① To use  
Lift up the head restraint until it locks.
- ② To fold  
Pull the strap to fold the head restraint.

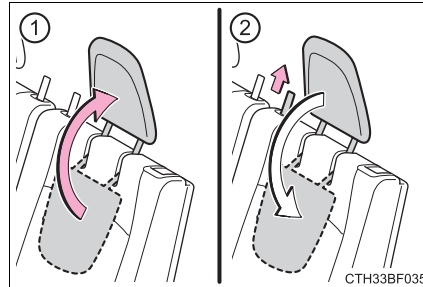

**Removing the head restraints (except third row seats)**

Pull the head restraint up while pressing the lock release button.

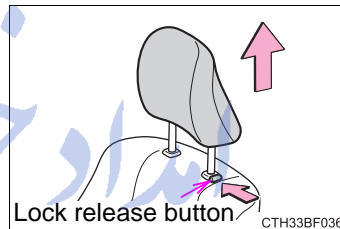

**Installing the head restraints (except third row seats)**

Align the head restraint with the installation holes and push it down to the lock position. Press and hold the lock release button when lowering the head restraint.

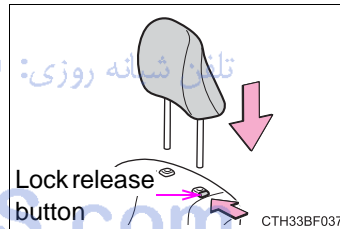

**Adjusting the height of the head restraints (except third row seats)**

Make sure that the head restraints are adjusted so that the center of the head restraint is closest to the top of your ears.

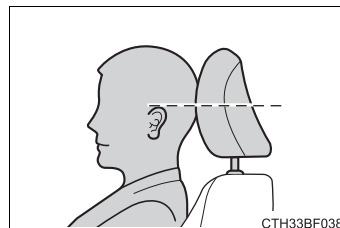

**Adjusting the second center seat head restraint**

Always raise the head restraint one level from the stowed position when using.

**⚠ CAUTION****■ Head restraint precautions**

Observe the following precautions regarding the head restraints. Failure to do so may result in death or serious injury.

- Use the head restraints designed for each respective seat.
- Adjust the head restraints to the correct position at all times.
- After adjusting the head restraints, push down on them and make sure they are locked in position.
- Do not drive with the head restraints removed.

امداد خودرو فارما

تلفن شبانه روزی: ۰۲۱-۸۸۸۶۲۰۸۵

FarmaSOS.com

## Steering wheel

The steering wheel can be adjusted to a comfortable position.

### Adjustment procedure

- 1 Hold the steering wheel and push the lever down.

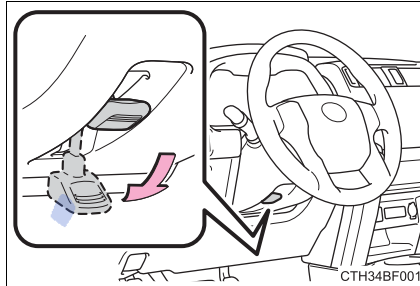

- 2 Adjust to the ideal position by moving the steering wheel horizontally and vertically.  
After adjustment, pull the lever up to secure the steering wheel.

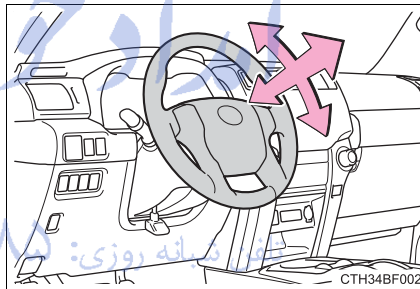

### Horn

To sound the horn, press on or close to the  mark.

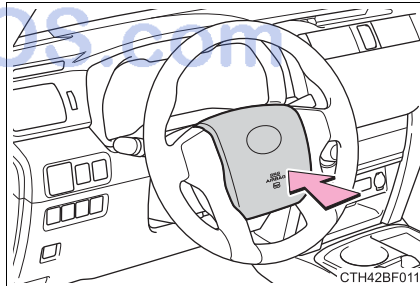

**⚠ CAUTION****■ Caution while driving**

Do not adjust the steering wheel while driving.  
Doing so may cause the driver to mishandle the vehicle and cause an accident, resulting in death or serious injury.

**■ After adjusting the steering wheel**

Make sure that the steering wheel is securely locked.  
Otherwise, the steering wheel may move suddenly, possibly causing an accident, and resulting in death or serious injury. Also, the horn may not sound if the steering wheel is not securely locked.

امداد خودرو فارما

تلفن شبانه روزی: ۰۲۱-۸۸۸۶۲۰۸۵

FarmaSOS.com

## Inside rear view mirror

The rear view mirror's position can be adjusted to enable sufficient confirmation of the rear view.

### Adjusting the height of rear view mirror

The height of the rear view mirror can be adjusted to suit your driving posture.

Adjust the height of the rear view mirror by moving it up and down.

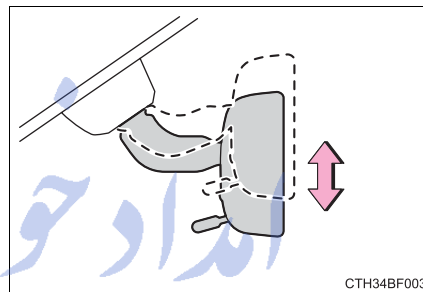

### Anti-glare function

► Manual anti-glare inside rear view mirror

- ① Normal position
- ② Anti-glare position

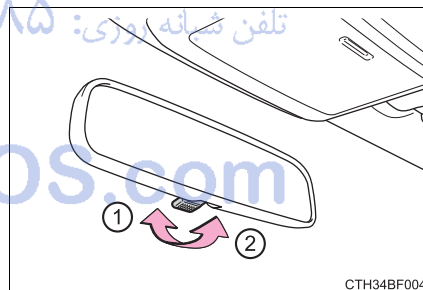

► Auto anti-glare inside rear view mirror

Responding to the level of brightness of the headlights of vehicles behind, the reflected light is automatically reduced.

Changing automatic anti-glare function mode

ON/OFF

When the automatic anti-glare function is in on mode, the indicator illuminates.

Vehicles without a smart key system:

The function will set to on mode each time the engine switch is turned to the "ON" position.

Pressing the button turns the function to off mode. (The indicator also turns off.)

Vehicles with a smart key system:

The function will set to on mode each time the engine switch is turned to IGNITION ON mode.

Pressing the button turns the function to off mode. (The indicator also turns off.)

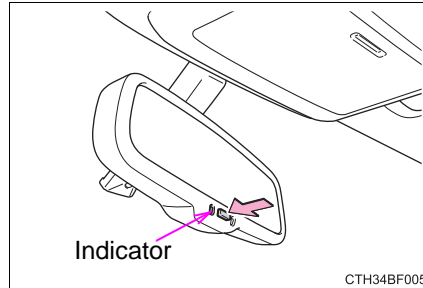

3

Operation of each component

■ To prevent sensor error (auto anti-glare type)

To ensure that the sensors operate properly, do not touch or cover them.

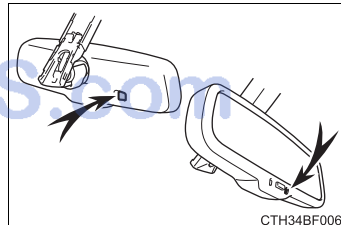

⚠ CAUTION

Do not adjust the position of the mirror while driving. Doing so may lead to mishandling of the vehicle and cause an accident, resulting in death or serious injury.

## Outside rear view mirrors

### Adjustment procedure

- 1 To select a mirror to adjust, press the switch.

- ① Left
- ② Right

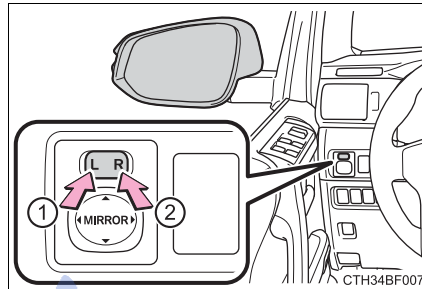

- 2 To adjust the mirror, press the switch.

- ① Up
- ② Right
- ③ Down
- ④ Left

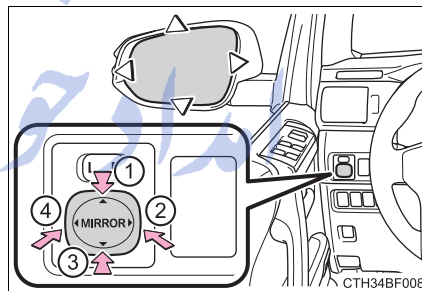

### Folding the mirrors

Push the mirror back in the direction of the vehicle's rear.

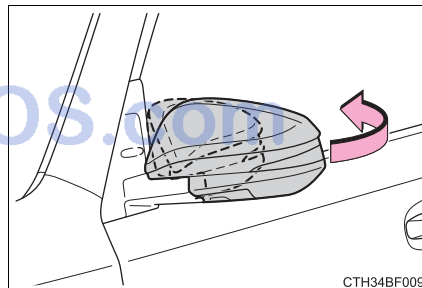



#### ■ Mirror angle can be adjusted when

- ▶ Vehicles without a smart key system

The engine switch is in the “ACC” or “ON” position.

- ▶ Vehicles with a smart key system

The engine switch is in ACCESSORY or IGNITION ON mode.

#### ■ When the mirrors are fogged up

The outside rear view mirrors can be cleared using the mirror defoggers. Turn on the rear window defogger to turn on the outside rear view mirror defoggers. (→P. 282, 288)

#### ⚠ CAUTION

##### ■ Important points while driving

Observe the following precautions while driving.

Failure to do so may result in loss of control of the vehicle and cause an accident, resulting in death or serious injury.

- Do not adjust the mirrors while driving.
- Do not drive with the mirrors folded.
- Both the driver and passenger side mirrors must be extended and properly adjusted before driving.

##### ■ When a mirror is moving

To avoid personal injury and mirror malfunction, be careful not to get your hand caught by the moving mirror.

##### ■ When the mirror defoggers are operating

Do not touch the rear view mirror surfaces, as they can become very hot and burn you.

## Power windows

### Opening and closing procedures

The power windows can be opened and closed using the switches.

Operating the switch moves the windows as follows:

- ① Closing
- ② One-touch closing\*
- ③ Opening
- ④ One-touch opening\*

\*:To stop the window partway, operate the switch in the opposite direction.

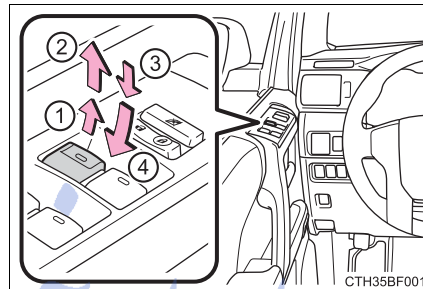

### Window lock switch

Press the switch to lock the passenger window switches and back window switch.

Use this switch to prevent children from accidentally opening or closing a passenger window.

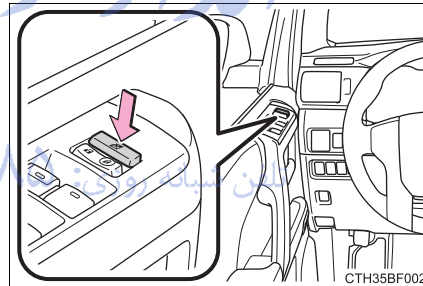

FarmaSOS.com

#### ■ The power windows can be operated when

- ▶ Vehicles without a smart key system

The engine switch is in the “ACC” or “ON” position.

- ▶ Vehicles with a smart key system

The engine switch is in IGNITION ON mode.

#### ■ Operating the power windows after turning the engine off

- ▶ Vehicles without a smart key system

The power windows can be operated for approximately 45 seconds even after the engine switch is turned to the “ACC” or “LOCK” position. They cannot, however, be operated once either front door is opened.

- ▶ Vehicles with a smart key system

The power windows can be operated for approximately 45 seconds even after the engine switch is turned to ACCESSORY mode or turned off. They cannot, however, be operated once either front door is opened.

#### ■ Jam protection function

If an object becomes caught between the window and the window frame, window travel is stopped and the window is opened slightly.

#### ■ When the power window does not close normally

If the jam protection function is operating abnormally and a window cannot be closed, perform the following operations using the power window switch on the relevant door.

- Vehicles without a smart key system: After stopping the vehicle, the window can be closed by holding the power window switch in the one-touch closing position while the engine switch is turned to the “ON” position.
- Vehicles with a smart key system: After stopping the vehicle, the window can be closed by holding the power window switch in the one-touch closing position while the engine switch is turned to IGNITION ON mode.
- If the window still cannot be closed even by carrying out the operation as explained above, initialize the function by performing the following procedure.

- 1 Hold the power window switch in the one-touch closing position. Continue holding the switch for a further 6 seconds after the window has closed.
- 2 Hold the power window switch in the one-touch opening position. Continue holding the switch for a further 2 seconds after the window has opened completely.
- 3 Hold the power window switch in the one-touch closing position once again. Continue holding the switch for a further 2 seconds after the window has closed.

If you release the switch while the window is moving, start again from the beginning.

If the window continues to close but then re-open slightly even after performing the above procedure correctly, have the vehicle inspected by your Toyota dealer.

**■ Customization**

Settings (e.g. key linked operation) can be changed.  
(Customizable features →P. 485)

**⚠ CAUTION**

Observe the following precautions.  
Failure to do so may result in death or serious injury.

**■ Closing the windows**

- Check to make sure that all passengers do not have any part of their body in a position where it could be caught when a window is being operated.
- Do not allow children to operate the power windows.  
Closing a power window on someone can cause death or serious injury.  
The driver is responsible for instructing children not to operate the power windows.

**■ Jam protection function**

- Never use any part of your body to intentionally activate the jam protection function.
- The jam protection function may not work if something gets caught just before the window fully closes.

تلفن شبانه روزی: ۰۲۱-۸۸۶۲۰۸۵

FarmaSOS.com

## Power back window

The power back window can be opened and closed using the switch or key.

### Opening and closing procedures

► From inside the vehicle

- ① Closing
- ② One-touch closing\*
- ③ Opening
- ④ One-touch opening\*

\*: To stop the window partway, operate the switch in the opposite direction.

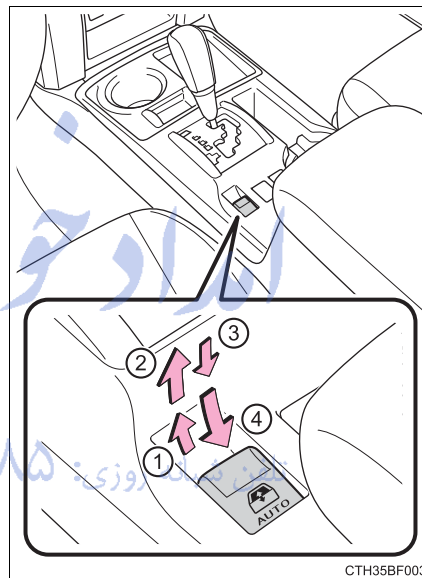

► From outside the vehicle (vehicles without a smart key system)

- ① Opening
- ② Closing

Turn the key fully and hold it.

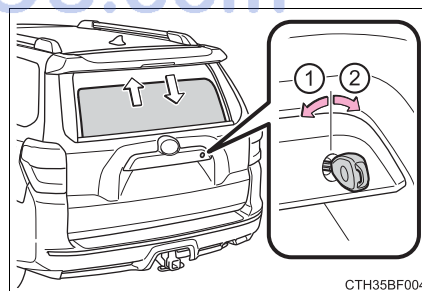

► From outside the vehicle (vehicles with a smart key system)

- ① Opening (push and hold)
- ② Closing (push and hold)

This operation can only be performed when the electronic key is within the detection range.

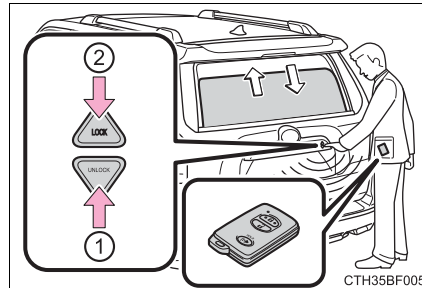

■ **The power back window can be operated from inside the vehicle when**

► Vehicles without a smart key system

The engine switch is in the "ON" position.

► Vehicles with a smart key system

The engine switch is in IGNITION ON mode.

- The power back window can be opened when the rear window wiper is working, but the wiper stops working until the window is closed again. If the power back window is not fully closed, the rear window wiper, washer, and defogger will not work.
- If the back door is not fully closed, the power back window cannot be opened using the switch located in the cabin. (It is still possible to close the window.)
- If the back door is opened while the power back window is opening or closing, window operation will stop.

■ **The power back window can be operated from outside the vehicle when (vehicles with a smart key system)**

- The engine switch is off.
- The back door is closed.

### ■ Operating the power back window from inside the vehicle after turning the engine off

#### ▶ Vehicles without a smart key system

The power back window can be operated for approximately 45 seconds even after the engine switch is turned to the "ACC" or "LOCK" position. It cannot, however, be operated once either front door is opened.

#### ▶ Vehicles with a smart key system

The power back window can be operated for approximately 45 seconds even after the engine switch is turned to ACCESSORY mode or turned off. It cannot, however, be operated once either front door is opened.

### ■ Jam protection function

If an object becomes caught between the window and the window frame, window travel is stopped and the window is opened slightly.

### ■ When the power back window does not close normally

If the jam protection function is operating abnormally and a window cannot be closed, perform the following operations using the power back window switch.

- Vehicles without a smart key system: After stopping the vehicle, the window can be closed by holding the power back window switch in the one-touch closing position while the engine switch is turned to the "ON" position.
- Vehicles with a smart key system: After stopping the vehicle, the window can be closed by holding the power back window switch in the one-touch closing position while the engine switch is turned to IGNITION ON mode.
- If the window still cannot be closed even by carrying out the operation explained above, initialize the function by performing the following procedure.

- 1 Hold the power back window switch in the one-touch closing position. Continue holding the switch for a further 6 seconds after the window has closed.
- 2 Hold the power back window switch in the one-touch opening position. Continue holding the switch for a further 2 seconds after the window has opened completely.
- 3 Hold the power back window switch in the one-touch closing position once again. Continue holding the switch for a further 2 seconds after the window has closed.

If you release the switch while the window is moving, start again from the beginning.

If the window continues to close but then re-open slightly even after performing the above procedure correctly, have the vehicle inspected by your Toyota dealer.

### ■ Customization

Settings (e.g. linked operation) can be changed.  
(Customizable features →P. 485)

**⚠ CAUTION**

Observe the following precautions.

Failure to do so may result in death or serious injury.

**■ Caution while driving**

Keep the back door and back window closed while driving. If the back door or the back window is left open, the back door may hit nearby objects while driving or luggage may be unexpectedly thrown out, causing an accident. In addition, exhaust gases may enter the vehicle, causing death or a serious health hazard. Make sure to close the back door and back window before driving.

**■ Closing the power back window**

- Check to make sure that all passengers do not have any part of their body in a position where it could be caught when a window is being operated.
- Do not allow children to operate the power back window.  
Closing a power back window on someone can cause death or serious injury.  
The driver is responsible for instructing children not to operate the power back window.

**■ Jam protection function**

- Never use any part of your body to intentionally activate the jam protection function.
- The jam protection function may not work if something gets caught just before the window fully closes.

FarmaSOS.com



## Moon roof\*

Use the overhead switches to open and close the moon roof and tilt it up and down.

### Opening and closing

- ① Opens the moon roof\*  
The moon roof stops slightly before the fully open position to reduce wind noise.  
Press the switch again to fully open the moon roof.
- ② Closes the moon roof\*  
\*: Lightly press either way of the moon roof switch to stop the moon roof partway.

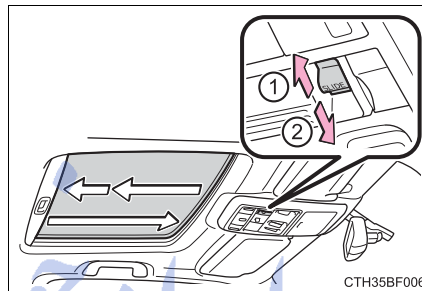

### Tilting up and down

- ① Tilts the moon roof up\*
- ② Tilts the moon roof down\*  
\*: Lightly press either way of the moon roof switch to stop the moon roof partway.

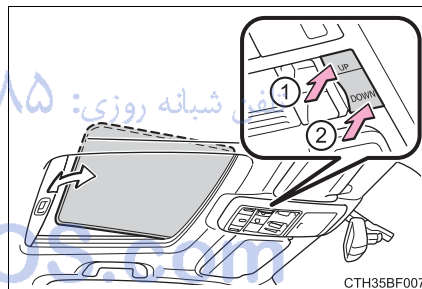

3

Operation of each component

\*: If equipped

■ **The moon roof can be operated when**

- ▶ Vehicles without a smart key system

The engine switch is in the “ON” position.

- ▶ Vehicles with a smart key system

The engine switch is in IGNITION ON mode.

■ **Operating the moon roof after turning the engine off**

- ▶ Vehicles without a smart key system

The moon roof can be operated for approximately 45 seconds even after the engine switch is turned to the “ACC” or “LOCK” position. They cannot, however, be operated once either front door is opened.

- ▶ Vehicles with a smart key system

The moon roof can be operated for approximately 45 seconds after the engine switch is turned to ACCESSORY mode or turned off. It cannot, however, be operated once either front door is opened.

■ **Jam protection function**

If an object is detected between the moon roof and the frame while the moon roof is closing or tilting down, travel is stopped and the moon roof opens slightly.

■ **To reduce moon roof wind noise**

When the moon roof is opened automatically, it will stop slightly before the fully open position. Driving with the moon roof in this position can help reduce wind noise.

■ **Sunshade** • ۲۱-۸۸۸۶۲۰۸۵: تلفن شبانه روزی

The sunshade can be opened and closed manually. However, the sunshade will open automatically when the moon roof is opened.

FarmaSOS.com

### ■ When the moon roof does not close normally

Perform the following procedure:

- If the moon roof closes but then re-opens slightly

- 1 Stop the vehicle.
- 2 Press and hold the "SLIDE (open/close)" switch in the close position. \*1  
The moon roof will close, reopen and pause for approximately 10 seconds. \*2 Then it will close again, tilt up and pause for approximately 1 second. Finally, it will tilt down, open and close.
- 3 Check to make sure that the moon roof is completely closed and then release the switch.

- If the moon roof tilts down but then tilts back up

- 1 Stop the vehicle.
- 2 Press and hold the "UP" switch\*1 until the moon roof moves into the tilt up position and stops.
- 3 Release the "UP" switch once and then press and hold the "UP" switch again. \*1  
The moon roof will pause for approximately 10 seconds in the tilt up position. \*2 Then it will adjust slightly and pause for approximately 1 second. Finally, it will tilt down, open and close.
- 4 Check to make sure that the moon roof is completely closed and then release the switch.

\*1: If the switch is released at the incorrect time, the procedure will have to be performed again from the beginning.

\*2: If the switch is released after the above mentioned 10 second pause, automatic operation will be disabled. In that case, press and hold the "UP" or "DOWN" switch, and the moon roof will tilt up and pause for approximately 1 second. Then it will tilt down, open and close. Check to make sure that the moon roof is completely closed and then release the switch.

If the moon roof does not fully close even after performing the above procedure correctly, have the vehicle inspected by your Toyota dealer.

### ■ Moon roof open reminder function

An alarm will sound when the driver's door is opened with the moon roof not fully closed and the engine switch off.

### ■ Customization that can be configured at Toyota dealer

Settings (e.g. key linked operation) can be changed.  
(Customizable features →P. 485)

**⚠ CAUTION**

Observe the following precautions.

Failure to do so may cause death or serious injury.

**■ Opening the moon roof**

- Do not allow any passengers to put their hands or heads outside the vehicle while it is moving.
- Do not sit on top of the moon roof.

**■ Closing the moon roof**

- Check to make sure that all passengers do not have any part of their body in a position where it could be caught when the moon roof is being operated.
- Do not allow children to operate the moon roof.  
Closing the moon roof on someone can cause death or serious injury.  
The driver is responsible for instructing children not to operate the moon roof.

**■ Jam protection function**

- Never use any part of your body to intentionally activate the jam protection function.
- The jam protection function may not work if something gets caught just before the moon roof fully closes.

تلفن شبانه روزی: ۰۲۱-۸۸۸۶۲۰۸۵

FarmaSOS.com

## Driving

## 4

<b>4-1. Before driving</b>		<b>4-4. Refueling</b>	
Driving the vehicle.....	160	Opening the fuel tank cap .....	219
Cargo and luggage .....	170	<b>4-5. Using the driving support systems</b>	
Vehicle load limits .....	175	Cruise control.....	222
Trailer towing.....	176	Intuitive parking assist.....	226
Dinghy towing .....	191	Four-wheel drive system (part-time 4WD models) .....	232
<b>4-2. Driving procedures</b>		Four-wheel drive system (full-time 4WD models) .....	236
Engine (ignition) switch (vehicles without a smart key system).....	192	Active traction control system .....	240
Engine (ignition) switch (vehicles with a smart key system).....	195	AUTO LSD system.....	242
Automatic transmission.....	200	Rear differential lock system .....	244
Turn signal lever.....	203	Downhill assist control system .....	247
Parking brake .....	204	Crawl Control .....	250
<b>4-3. Operating the lights and wipers</b>		Multi-terrain Select .....	253
Headlight switch .....	205	Driving assist systems .....	260
Fog light switch .....	211	<b>4-6. Driving tips</b>	
Windshield wipers and washer .....	213	Winter driving tips .....	269
Rear window wiper and washer .....	216	Off-road precautions .....	273

## Driving the vehicle

The following procedures should be observed to ensure safe driving:

### Starting the engine

→P. 195

### Driving

- 1 With the brake pedal depressed, shift the shift lever to D. (→P. 200)
- 2 Release the parking brake. (→P. 204)
- 3 Gradually release the brake pedal and gently depress the accelerator pedal to accelerate the vehicle.

### Stopping

- 1 With the shift lever in D, depress the brake pedal until the vehicle comes to a stop.
- 2 If necessary, set the parking brake.

If the vehicle is to be stopped for an extended period of time, shift the shift lever to P or N. (→P. 200)

### Parking the vehicle

- 1 With the shift lever in D, depress the brake pedal.
- 2 Set the parking brake. (→P. 204)
- 3 Shift the shift lever to P. (→P. 200)  
If parking on a hill, block the wheels as needed.
- 4 Vehicles without a smart key system:  
Turn the engine switch to the "LOCK" position to stop the engine.  
Vehicles with a smart key system:  
Press the engine switch to stop the engine.
- 5 Lock the door, making sure that you have the key on your person.

### Starting off on a steep uphill

- 1 Make sure that the parking brake is set and shift the shift lever to D.
- 2 Gently depress the accelerator pedal.
- 3 Release the parking brake.

### Driving in the rain

- Drive carefully when it is raining, because visibility will be reduced, the windows may become fogged-up, and the road will be slippery.
- Drive carefully when it starts to rain, because the road surface will be especially slippery.
- Refrain from driving at high speeds in the rain, as there may be a layer of water between the tires and the road surface, preventing the steering and brakes from operating properly.

### Engine speed while driving

In the following conditions, the engine speed may become high while driving. This is due to automatic up-shifting control or down-shifting implementation to meet driving conditions. It does not indicate sudden acceleration.

- The vehicle is judged to be driving uphill or downhill
- When the accelerator pedal is released

### Breaking in your new Toyota

To extend the life of the vehicle, observing the following precautions is recommended:

- For the first 200 miles (300 km):  
Avoid sudden stops.
- For the first 500 miles (800 km):  
Do not tow a trailer.
- For the first 1000 miles (1600 km):
  - Do not drive at extremely high speeds.
  - Avoid sudden acceleration.
  - Do not drive continuously in low gears.
  - Do not drive at a constant speed for extended periods.

**■ Drum-in-disc type parking brake system**

Your vehicle has a drum-in-disc type parking brake system. This type of brake system needs bedding-down of the brake shoes periodically or whenever the parking brake shoes and/or drum are replaced. Have your Toyota dealer perform the bedding down operation.

**■ Operating your vehicle in a foreign country**

Comply with the relevant vehicle registration laws and confirm the availability of the correct fuel. (→P. 470)

**■ When turning off the engine**

The emission system operating sounds may continue for a short time after the engine is turned off. This is not a malfunction, and helps to ensure optimal performance of the emission system.

**⚠ CAUTION**

Observe the following precautions.  
Failure to do so may result in death or serious injury.

**■ When starting the vehicle**

Always keep your foot on the brake pedal while stopped with the engine running. This prevents the vehicle from creeping.

**■ When driving the vehicle**

- Do not drive if you are unfamiliar with the location of the brake and accelerator pedals to avoid depressing the wrong pedal.
  - Accidentally depressing the accelerator pedal instead of the brake pedal will result in sudden acceleration that may lead to an accident.
  - When backing up, you may twist your body around, leading to a difficulty in operating the pedals. Make sure to operate the pedals properly.
  - Make sure to keep a correct driving posture even when moving the vehicle only slightly. This allows you to depress the brake and accelerator pedals properly.
  - Depress the brake pedal using your right foot. Depressing the brake pedal using your left foot may delay response in an emergency, resulting in an accident.
- Do not drive the vehicle over or stop the vehicle near flammable materials. The exhaust system and exhaust gases can be extremely hot. These hot parts may cause a fire if there is any flammable material nearby.



 CAUTION

Observe the following precautions.

Failure to do so may result in death or serious injury.

■ **When driving the vehicle**

- During normal driving, do not turn off the engine. Turning the engine off while driving will not cause loss of steering or braking control, but the power assist to these systems will be lost. This will make it more difficult to steer and brake, so you should pull over and stop the vehicle as soon as it is safe to do so.  
However, in the event of an emergency, such as if it becomes impossible to stop the vehicle in the normal way: →P. 409
- Use engine braking (downshift) to maintain a safe speed when driving down a steep hill.  
Using the brakes continuously may cause the brakes to overheat and lose effectiveness. (→P. 200)
- Do not adjust the positions of the steering wheel, the seat, or the inside or outside rear view mirrors while driving.  
Doing so may result in a loss of vehicle control.
- Always check that all passengers' arms, heads or other parts of their body are not outside the vehicle.
- Do not drive in excess of the speed limit. Even if the legal speed limit permits it, do not drive over 85 mph (140 km/h) unless your vehicle has high-speed capability tires. Driving over 85 mph (140 km/h) may result in tire failure, loss of control and possible injury. Be sure to consult a tire dealer to determine whether the tires on your vehicle are high-speed capability tires or not before driving at such speeds.

 CAUTION

Observe the following precautions.

Failure to do so may result in death or serious injury.

■ **When driving on slippery road surfaces**

- Sudden braking, acceleration and steering may cause tire slippage and reduce your ability to control the vehicle.
- Sudden acceleration, engine braking due to shift changing, or changes in engine speed could cause the vehicle to skid.
- After driving through a puddle, lightly depress the brake pedal to make sure that the brakes are functioning properly. Wet brake pads may prevent the brakes from functioning properly. If the brakes on only one side are wet and not functioning properly, steering control may be affected.

■ **When shifting the shift lever**

- Do not let the vehicle roll backward while the shift lever is in a driving position, or roll forward while the shift lever is in R.  
Doing so may cause the engine to stall or lead to poor brake and steering performance, resulting in an accident or damage to the vehicle.
- Do not shift the shift lever to P while the vehicle is moving.  
Doing so can damage the transmission and may result in a loss of vehicle control.
- Do not shift the shift lever to R while the vehicle is moving forward.  
Doing so can damage the transmission and may result in a loss of vehicle control.
- Do not shift the shift lever to D while the vehicle is moving backward.  
Doing so can damage the transmission and may result in a loss of vehicle control.
- Moving the shift lever to N while the vehicle is moving will disengage the engine from the transmission. Engine braking is not available when N is selected.
- Be careful not to shift the shift lever with the accelerator pedal depressed. Shifting the shift lever to a gear other than P or N may lead to unexpected rapid acceleration of the vehicle that may cause an accident and result in death or serious injury.

 CAUTION

Observe the following precautions.

Failure to do so may result in death or serious injury.

■ **If you hear a squealing or scraping noise (brake pad wear limit indicators)**

Have the brake pads checked and replaced by your Toyota dealer as soon as possible.

Rotor damage may result if the pads are not replaced when needed.

It is dangerous to drive the vehicle when the wear limits of the brake pads and/or those of the brake discs are exceeded.

■ **When the vehicle is stopped**

- Do not race the engine.

If the vehicle is in any gear other than P or N, the vehicle may accelerate suddenly and unexpectedly, causing an accident.

- In order to prevent accidents due to the vehicle rolling away, always keep depressing the brake pedal while the engine is running, and apply the parking brake as necessary.

- If the vehicle is stopped on an incline, in order to prevent accidents caused by the vehicle rolling forward or backward, always depress the brake pedal and securely apply the parking brake as needed.

- Avoid revving or racing the engine.

Running the engine at high speed while the vehicle is stopped may cause the exhaust system to overheat, which could result in a fire if combustible material is nearby.

 CAUTION

Observe the following precautions.  
Failure to do so may result in death or serious injury.

**■ When the vehicle is parked**

- Do not leave glasses, cigarette lighters, spray cans, or soft drink cans in the vehicle when it is in the sun.  
Doing so may result in the following:
  - Gas may leak from a cigarette lighter or spray can, and may lead to a fire.
  - The temperature inside the vehicle may cause the plastic lenses and plastic material of glasses to deform or crack.
  - Soft drink cans may fracture, causing the contents to spray over the interior of the vehicle, and may also cause a short circuit in the vehicle's electrical components.
- Do not leave cigarette lighters in the vehicle. If a cigarette lighter is in a place such as the glove box or on the floor, it may be lit accidentally when luggage is loaded or the seat is adjusted, causing a fire.
- Do not attach adhesive discs to the windshield or windows. Do not place containers such as air fresheners on the instrument panel or dashboard. Adhesive discs or containers may act as lenses, causing a fire in the vehicle.
- Do not leave a door or window open if the curved glass is coated with a metallized film such as a silver-colored one. Reflected sunlight may cause the glass to act as a lens, causing a fire.
- Always apply the parking brake, shift the shift lever to P, stop the engine and lock the vehicle.  
Do not leave the vehicle unattended while the engine is running.
- Do not touch the exhaust pipes while the engine is running or immediately after turning the engine off.  
Doing so may cause burns.

 CAUTION

Observe the following precautions.

Failure to do so may result in death or serious injury.

■ **When taking a nap in the vehicle**

Always turn the engine off. Otherwise, if you accidentally move the shift lever or depress the accelerator pedal, this could cause an accident or fire due to engine overheating. Additionally, if the vehicle is parked in a poorly ventilated area, exhaust gases may collect and enter the vehicle, leading to death or a serious health hazard.

■ **When braking**

- When the brakes are wet, drive more cautiously.  
Braking distance increases when the brakes are wet, and this may cause one side of the vehicle to brake differently than the other side. Also, the parking brake may not securely hold the vehicle.
- If the power brake assist function does not operate, do not follow other vehicles closely and avoid hills or sharp turns that require braking.  
In this case, braking is still possible, but the brake pedal should be depressed more firmly than usual. Also, the braking distance will increase.
- Do not pump the brake pedal if the engine stalls.  
Each push on the brake pedal uses up the reserve for the power-assisted brakes.
- The brake system consists of 2 individual hydraulic systems; if one of the systems fails, the other will still operate. In this case, the brake pedal should be depressed more firmly than usual and the braking distance will increase.  
If this happens, do not continue to drive the vehicle. Have your brakes fixed immediately.

 NOTICE

■ **When driving the vehicle**

- Do not depress the accelerator and brake pedals at the same time during driving, as this may restrain driving torque.
- Do not use the accelerator pedal or depress the accelerator and brake pedals at the same time to hold the vehicle on a hill.

■ **When parking the vehicle**

Always shift the shift lever to P. Failure to do so may cause the vehicle to move or the vehicle may accelerate suddenly if the accelerator pedal is accidentally depressed.

■ **Avoiding damage to vehicle parts**

- Do not turn the steering wheel fully in either direction and hold it there for an extended period of time.  
Doing so may damage the power steering pump.
- When driving over bumps in the road, drive as slowly as possible to avoid damaging the wheels, underside of the vehicle, etc.

■ **If you get a flat tire while driving**

A flat or damaged tire may cause the following situations. Hold the steering wheel firmly and gradually depress the brake pedal to slow down the vehicle.

- It may be difficult to control your vehicle.
- The vehicle will make abnormal sounds or vibrations.
- The vehicle will behave abnormally.

Information on what to do in case of a flat tire (→P. 433)

FarmaSOS.com

 NOTICE**■ When encountering flooded roads**

Do not drive on a road that has flooded after heavy rain etc. Doing so may cause the following serious damage to the vehicle:

- Engine stalling
- Short in electrical components
- Engine damage caused by water immersion

In the event that you drive on a flooded road and the vehicle is flooded, be sure to have your Toyota dealer check the following:

- Brake function
- Changes in quantity and quality of oil and fluid used for the engine, transmission, transfer (4WD models), differentials, etc.
- Lubricant condition for the propeller shaft, bearings and suspension joints (where possible), and the function of all joints, bearings, etc.

امداد خودرو فارما  
تلفن شبانه روزی: ۰۲۱-۸۸۶۲۰۸۵

FarmaSOS.com

## Cargo and luggage

**Take notice of the following information about storage precautions, cargo capacity and load:**

- Stow cargo and luggage in the luggage compartment whenever possible.
- Be sure all items are secured in place.
- To maintain vehicle balance while driving, position luggage evenly within the luggage compartment.
- For better fuel economy, do not carry unnecessary weight.

امداد خودرو فارما

تلفن شبانه روزی: ۰۲۱-۸۸۸۶۲۰۸۵

FarmaSOS.com



### Capacity and distribution

Cargo capacity depends on the total weight of the occupants.

(Cargo capacity) = (Total load capacity) — (Total weight of occupants)

#### Steps for Determining Correct Load Limit—

- (1) Locate the statement “The combined weight of occupants and cargo should never exceed XXX kg or XXX lbs.” on your vehicle's placard.
- (2) Determine the combined weight of the driver and passengers that will be riding in your vehicle.
- (3) Subtract the combined weight of the driver and passengers from XXX kg or XXX lbs.
- (4) The resulting figure equals the available amount of cargo and luggage load capacity.  
For example, if the “XXX” amount equals 1400 lbs. and there will be five 150 lb passengers in your vehicle, the amount of available cargo and luggage load capacity is 650 lbs.  $(1400 - 750 (5 \times 150) = 650 \text{ lbs.})$
- (5) Determine the combined weight of luggage and cargo being loaded on the vehicle. That weight may not safely exceed the available cargo and luggage load capacity calculated in Step 4.
- (6) If your vehicle will be towing a trailer, load from your trailer will be transferred to your vehicle. Consult this manual to determine how this reduces the available cargo and luggage load capacity of your vehicle.  
(→P. 460)

**Calculation formula for your vehicle**

- ① Cargo capacity
- ② Total load capacity (vehicle capacity weight) (→P. 460)

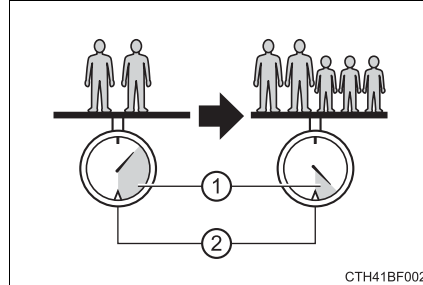

When 2 people with the combined weight of A lb. (kg) are riding in your vehicle, which has a total load capacity (vehicle capacity weight) of B lb. (kg), the available amount of cargo and luggage load capacity will be C lb. (kg) as follows:

$$B^{*2} \text{ lb. (kg)} - A^{*1} \text{ lb. (kg)} = C^{*3} \text{ lb. (kg)}$$

\*1: A =Weight of people

\*2: B =Total load capacity

\*3: C =Available cargo and luggage load

In this condition, if 3 more passengers with the combined weight of D lb. (kg) get on, the available cargo and luggage load will be reduced E lb. (kg) as follows:

$$C \text{ lb. (kg)} - D^{*4} \text{ lb. (kg)} = E^{*5} \text{ lb. (kg)}$$

\*4: D =Additional weight of people

\*5: E =Available cargo and luggage load

As shown in the example above, if the number of occupants increases, the cargo and luggage load will be reduced by an amount that equals the increased weight due to the additional occupants. In other words, if an increase in the number of occupants causes an excess of the total load capacity (combined weight of occupants plus cargo and luggage load), you must reduce the cargo and luggage on your vehicle.

### ■ When using the roof rails (if equipped)

- To use the roof rails as a roof luggage carrier, you must fit the roof rails with two or more genuine Toyota cross rails or their equivalent.
- When there is no luggage on the roof luggage carrier Toyota recommends that the front and rear cross rails be secured in the positions indicated in the illustration. This may reduce wind noise while driving.

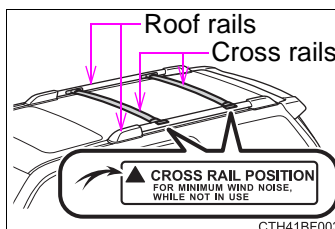

### ⚠ CAUTION

#### ■ Things that must not be carried in the luggage compartment

The following things may cause a fire if loaded in the luggage compartment:

- Receptacles containing gasoline
- Aerosol cans

#### ■ Storage precautions

Observe the following precautions.

Failure to do so may prevent the pedals from being depressed properly, may block the driver's vision, or may result in items hitting the driver or passengers, possibly causing an accident.

- Stow cargo and luggage in the luggage compartment whenever possible.
- Do not stack cargo and luggage in the luggage compartment higher than the seatbacks.
- Do not place cargo or luggage in or on the following locations.
  - At the feet of the driver
  - On the front passenger or rear seats (when stacking items)
  - On the instrument panel
  - On the dashboard
- Secure all items in the occupant compartment.
- When you fold down the rear seats, long items should not be placed directly behind the front seats.
- Never allow anyone to ride in the luggage compartment. It is not designed for passengers. They should ride in their seats with their seat belts properly fastened. Otherwise, they are much more likely to suffer death or serious bodily injury, in the event of sudden braking, sudden swerving or an accident.

**⚠ CAUTION****■ Capacity and distribution**

- Do not exceed the maximum axle weight rating or the total vehicle weight rating.
- Even if the total load of occupant's weight and the cargo load is less than the total load capacity, do not apply the load unevenly. Improper loading may cause deterioration of steering or braking control which may cause death or serious injury.

**■ When loading cargo on the roof luggage carrier**

Observe the following precautions:

- Place the cargo so that its weight is distributed evenly between the front and rear axles.
- If loading long or wide cargo, never exceed the vehicle overall length or width. (→P. 460)
- Before driving, make sure the cargo is securely fastened on the roof luggage carrier.
- Loading cargo on the roof luggage carrier will make the center of gravity of the vehicle higher. Avoid high speeds, sudden starts, sharp turns, sudden braking or abrupt maneuvers, otherwise it may result in loss of control or vehicle rollover due to failure to operate this vehicle correctly and result in death or serious injury.
- If driving for a long distance, on rough roads, or at high speeds, stop the vehicle now and then during the trip to make sure the cross rails are fixed securely and that the cargo remains in its place.
- Do not exceed 120 lb. (54 kg) cargo weight on the roof luggage carrier.

**⚠ NOTICE****■ When loading cargo on the roof luggage carrier**

Be careful not to scratch the surface of the moon roof (if equipped).

## Vehicle load limits

**Vehicle load limits include total load capacity, seating capacity, TWR (Trailer Weight Rating) and cargo capacity.**

### ◆ Total load capacity (vehicle capacity weight): (→P. 460)

Total load capacity means the combined weight of occupants, cargo and luggage.

### ◆ Seating capacity

**Vehicle without third seats: 5 occupants (Front 2, Rear 3)**

**Vehicle with third seats: 7 occupants (Front 2, Rear 5)**

Seating capacity means the maximum number of occupants whose estimated average weight is 150 lb. (68 kg) per person.

### ◆ TWR (Trailer Weight Rating): (→P. 181, 460)

TWR means the maximum gross trailer weight (trailer weight plus its cargo weight) that your vehicle is able to tow.

### ◆ Cargo capacity

Cargo capacity may increase or decrease depending on the weight and the number of occupants.

### ■ Total load capacity and seating capacity

These details are also described on the tire and loading information label. (→P. 377)

#### CAUTION

#### ■ Overloading the vehicle

Do not overload the vehicle.

It may not only cause damage to the tires, but also degrade steering and braking ability, resulting in an accident.

## Trailer towing

**Your vehicle is designed primarily as a passenger-and-load-carrying vehicle. Towing a trailer can have an adverse impact on handling, performance, braking, durability, and fuel consumption. For your safety and the safety of others, you must not overload your vehicle or trailer. You must also ensure that you are using appropriate towing equipment, that the towing equipment has been installed correctly and used properly, and that you employ the requisite driving habits.**

**Vehicle-trailer stability and braking performance are affected by trailer stability, brake performance and setting, trailer brakes, the hitch and hitch systems (if equipped).**

**To tow a trailer safely, use extreme care and drive the vehicle in accordance with your trailer's characteristics and operating conditions.**

**Toyota warranties do not apply to damage or malfunction caused by towing a trailer for commercial purposes.**

**Contact your Toyota dealer for further information about additional requirements such as a towing kit, etc.**

FarmaSOS.com

### Towing related terms

#### ■ GCWR (Gross Combination Weight Rating)

The maximum allowable gross combination weight. The gross combination weight is the sum of the total vehicle weight (including the occupants, cargo and any optional equipment installed on the vehicle) and the weight of the trailer being towed (including the cargo in the trailer).

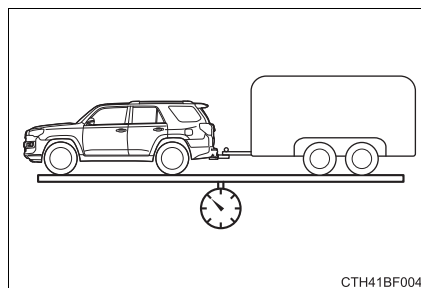

#### ■ GVWR (Gross Vehicle Weight Rating)

The maximum allowable gross vehicle weight. The gross vehicle weight is the total weight of the vehicle. When towing a trailer, it is the sum of the vehicle weight (including the occupants, cargo and any optional equipment installed on the vehicle) and the tongue weight.

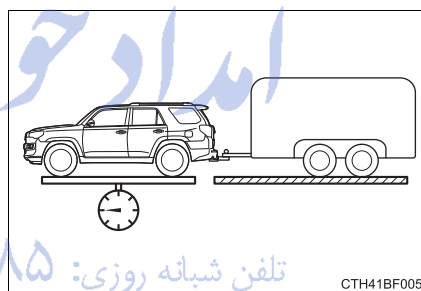

■ **GAWR (Gross Axle Weight Rating)**

The maximum allowable gross axle weight. The gross axle weight is the load placed on each axle (front and rear).

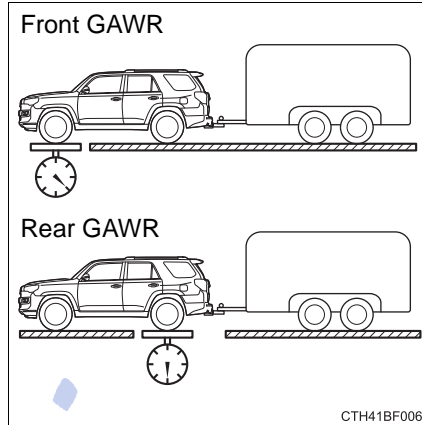

■ **TWR (Trailer Weight Rating)**

The maximum allowable gross trailer weight. The gross trailer weight is the sum of the trailer weight and the weight of the cargo in the trailer.

TWR is calculated assuming base vehicle with one driver, one front passenger, towing package (if available), hitch and hitch systems (if required).

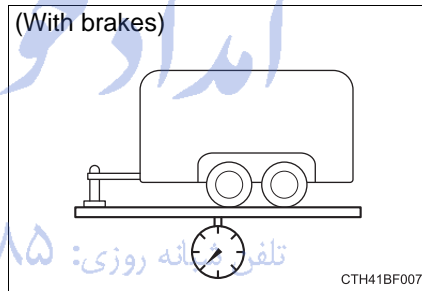

Additional optional equipment, passengers and cargo in the vehicle will reduce the trailer weight rating so as not to exceed GCWR, GVWR and GAWR.

If the gross trailer weight exceeds 3000 lb. (1360 kg), it is recommended to use a trailer with 2 or more axles.



### ■ Unbraked TWR (Unbraked Trailer Weight Rating)

The trailer weight rating for towing a trailer without a trailer service brake system.

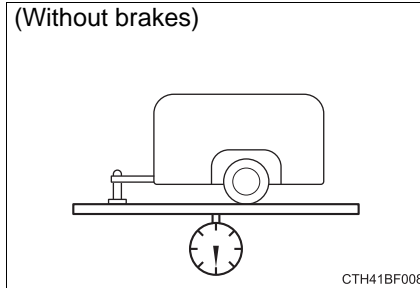

### ■ Tongue Weight

The load placed on the trailer hitch ball. (→P. 181)

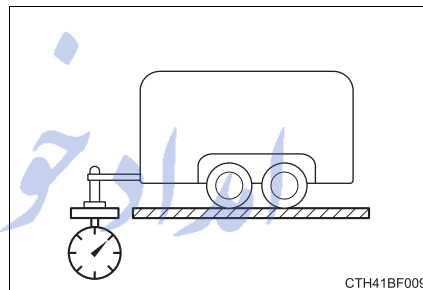

تلفن شبانه روزی: ۰۲۱-۸۸۸۶۲۰۸۵

FarmaSOS.com

### Weight limits

- The gross trailer weight must never exceed the TWR described in the table. (→P. 181)
- The gross combination weight must never exceed the GCWR described in the table. (→P. 181)
- The gross vehicle weight must never exceed the GVWR indicated on the Certification Label.
- The gross axle weight on each axle must never exceed the GAWR indicated on the Certification Label.
- If the gross trailer weight is over the unbraked TWR, trailer service brakes are required.
- If the gross trailer weight is over 2000 lb. (907 kg), a sway control device with sufficient capacity is required.

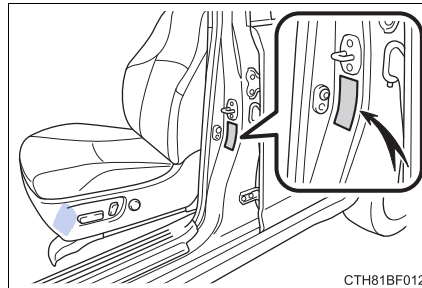

تلفن شبانه روزی: ۰۲۱-۸۸۸۶۲۰۸۵

FarmaSOS.com

### GCWR, TWR and Unbraked TWR

Confirm that the gross trailer weight, gross combination weight, gross vehicle weight, gross axle weight and tongue weight are all within the limits.

#### ■ GCWR\* and TWR\*

Driving system	Trailer Weight Rating	GCWR
2WD	5000 lb. (2270 kg)	11100 lb. (5035 kg)
4WD		11300 lb. (5125 kg)

#### ■ Unbraked TWR\*

1655 lb. (750 kg)

\*: These models meet the tow-vehicle trailering requirement of SAE International per SAE J2807.

### Trailer Tongue Weight

- A recommended tongue weight varies in accordance with the types of trailers or towing as described below.
- To ensure the recommended values shown below, the trailer must be loaded by referring to the following instructions.
  - Tongue Weight

The gross trailer weight should be distributed so that the tongue weight is 9% to 11%. (Tongue weight /Gross trailer weight x 100 = 9% to 11%)

- ① Gross trailer weight
- ② Tongue weight

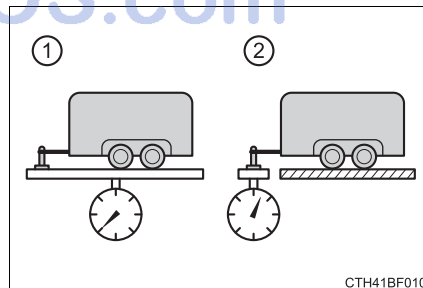

The gross trailer weight, gross axle weight and tongue weight can be measured with platform scales found at a highway weighing station, building supply company, trucking company, junk yard, etc.

### Hitch

Trailer hitch assemblies have different weight capacities. Toyota recommends the use of Toyota hitch/bracket for your vehicle. For details, contact your Toyota dealer.

- If you wish to install a trailer hitch, contact your Toyota dealer.
- Use only a hitch that conforms to the gross trailer weight requirement of your vehicle.
- Follow the directions supplied by the hitch manufacturer.
- Lubricate the hitch ball with a light coating of grease.
- Remove the trailer hitch whenever you are not towing a trailer. After removing the hitch, seal any mounting hole in the vehicle body to prevent entry of any substances into the vehicle.

امداد خودرو فارما

تلفن شبانه روزی: ۰۲۱-۸۸۸۶۲۰۸۵

FarmaSOS.com

### Selecting trailer ball

Use the correct trailer ball for your application.

- ① Trailer ball load rating  
Matches or exceeds the gross trailer weight rating of the trailer.
- ② Ball diameter  
Matches the size of the trailer coupler. Most couplers are stamped with the required trailer ball size.

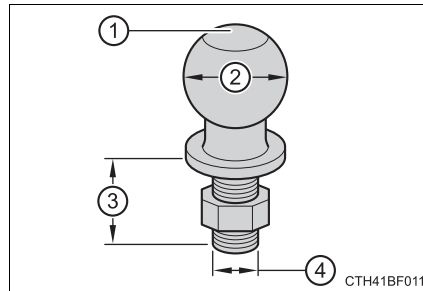

Trailer class	Typical trailer ball size
IV	2 5/16 in.
II and III	2 in.
I	1 7/8 in.

- ③ Shank length  
Protrudes beyond the bottom of the lock washer and nut by at least 2 threads.
- ④ Shank diameter  
Matches the ball mount hole diameter size.

FarmaSOS.com

### Positions for towing hitch receiver and hitch ball

- ① Weight carrying ball position:  
50.1 in. (1272 mm)
- ② Hitch receiver pin hole position:  
43.7 in. (1109 mm)

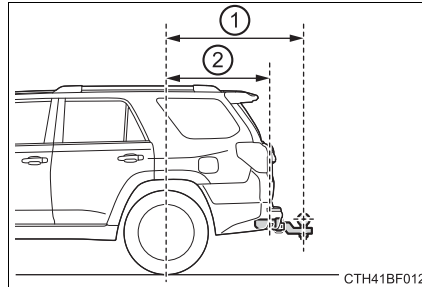

### Connecting trailer lights

Use the wire harness stored in the rear end under body.

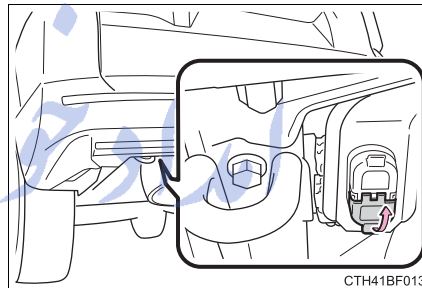

Please consult your dealer when installing trailer lights, as incorrect installation may cause damage to the vehicle's lights. Please take care to comply with your state's laws when installing trailer lights.

### Service connector for towing brake controller

Your vehicle is equipped with a service connector for the trailer brake controller as shown.

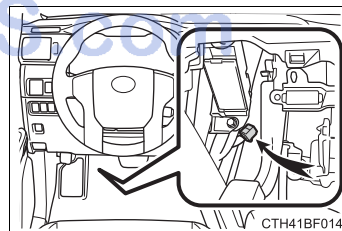

### Trailer towing tips

Your vehicle will handle differently when towing a trailer. Help to avoid an accident, death or serious injury, keep the following in mind when towing:

- Speed limits for towing a trailer vary by state or province. Do not exceed the posted towing speed limit.
- Toyota recommends that the vehicle-trailer speed limit is 65 mph (104 km/h) on a flat, straight, dry road. Do not exceed this limit, the posted towing speed limit or the speed limit for your trailer as set forth in your trailer owner's manual, whichever is lowest. Instability of the towing vehicle-trailer combination (trailer sway) increases as speed increases. Exceeding speed limits may cause loss of control.
- Before starting out, check the trailer lights, tires and the vehicle-trailer connections. Recheck after driving a short distance.
- Practice turning, stopping and reversing with the trailer attached in an area away from traffic until you become accustomed to the feel of the vehicle-trailer combination.
- Reversing with a trailer attached is difficult and requires practice. Grip the bottom of the steering wheel and move your hand to the left to move the trailer to the left. Move your hand to the right to move the trailer to right. (This is generally opposite to reversing without a trailer attached.) Avoid sharp or prolonged turning. Have someone guide you when reversing to reduce the risk of an accident.
- As stopping distance is increased when towing a trailer, vehicle-to-vehicle distance should be increased. For each 10 mph (16 km/h) of speed, allow at least one vehicle and trailer length.
- Avoid sudden braking as you may skid, resulting in the trailer jack-knifing and a loss of vehicle control. This is especially true on wet or slippery surfaces.

- Avoid jerky starts or sudden acceleration.
- Avoid jerky steering and sharp turns, and slow down before making turn.
- Note that when making a turn, the trailer wheels will be closer than the vehicle wheels to the inside of the turn. Compensate by making a wider than normal turning radius.
- Slow down before making a turn, in cross winds, on wet or slippery surfaces, etc.  
Increasing vehicle speed can destabilize the trailer.
- Take care when passing other vehicles. Passing requires considerable distance. After passing a vehicle, do not forget the length of your trailer, and be sure you have plenty of room before changing lanes.
- To maintain engine braking efficiency and charging system performance when using engine braking, do not put the transmission in D.
- Instability happens more frequently when descending steep or long downhill grades. Before descending, slow down and downshift. Do not make sudden downshifts while descending steep or long downhill grades.
- Avoid holding the brake pedal down too long or applying the brakes too frequently. This could cause the brakes to overheat and result in reduced braking efficiency.
- Due to the added load of the trailer, your vehicle's engine may overheat on hot days (at temperatures over 85°F [30°C]) when driving up a long or steep grade. If the engine coolant temperature gauge indicates overheating, immediately turn off the air conditioning (if in use), pull your vehicle off the road and stop in a safe spot.  
(→P. 455)



- Always place wheel blocks under both the vehicle's and the trailer's wheels when parking. Apply the parking brake firmly, and put the transmission in P. Avoid parking on a slope, but if unavoidable, do so only after performing the following:

- 1 Apply the brakes and keep them applied.
- 2 Have someone place wheel blocks under both the vehicle's and trailer's wheels.
- 3 When the wheel blocks are in place, release the brakes slowly until the blocks absorb the load.
- 4 Apply the parking brake firmly.
- 5 Shift into P and turn off the engine.

- When restarting after parking on a slope:

- 1 With the transmission in P, start the engine. Be sure to keep the brake pedal pressed.
- 2 Shift into a forward gear. If reversing, shift into R.
- 3 Release the parking brake and brake pedal, and slowly pull or back away from the wheel blocks. Stop and apply the brakes.
- 4 Have someone retrieve the blocks.

#### ■ Matching trailer ball height to trailer coupler height

No matter which class of tow hitch applies, for a more safe trailer hookup, the trailer ball setup must be the proper height for the coupler on the trailer.

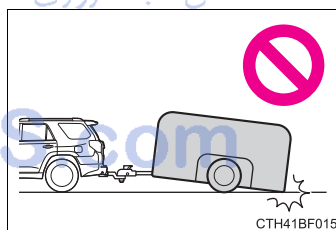

- ① Coupler
- ② Trailer ball

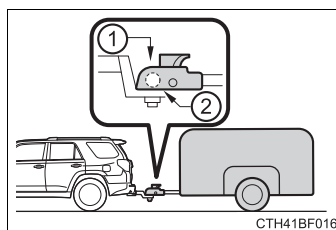

### ■ Before towing

Check that the following conditions are met:

- Ensure that your vehicle's tires are properly inflated. (→P. 468)
- Trailer tires are inflated according to the trailer manufacturer's recommendation.
- All trailer lights work as required by law.
- All lights work each time you connect them.
- The trailer ball is set at the proper height for the coupler on the trailer.
- The trailer is level when it is hitched.  
Do not drive if the trailer is not level, and check for improper tongue weight, overloading, worn suspension, or other possible causes.
- The trailer cargo is securely loaded.
- The rear view mirrors conform to all applicable federal, state/provincial or local regulations. If they do not, install rear view mirrors appropriate for towing purposes.

### ■ Break-in schedule

If your vehicle is new or equipped with any new power train components (such as an engine, transmission, differential or wheel bearing), Toyota recommends that you do not tow a trailer until the vehicle has been driven for over 500 miles (800 km).

After the vehicle has been driven for over 500 miles (800 km), you can start towing. However, for the next 500 miles (800 km), drive the vehicle at a speed of less than 45 mph (72 km/h) when towing a trailer, and avoid full throttle acceleration.

### ■ Maintenance

- If you tow a trailer, your vehicle will require more frequent maintenance due to the additional load. (See "Scheduled Maintenance Guide" or "Owner's Manual Supplement".)
- Retighten the fixing bolts of the towing ball and bracket after approximately 600 miles (1000 km) of trailer towing.

### ■ If trailer sway occurs

One or more factors (crosswinds, passing vehicles, rough roads, etc.) can adversely affect handling of your vehicle and trailer, causing instability.

- If trailer swaying occurs:
  - Firmly grip the steering wheel. Steer straight ahead.  
Do not try to control trailer swaying by turning the steering wheel.
  - Begin releasing the accelerator pedal immediately but very gradually to reduce speed.  
Do not increase speed. Do not apply vehicle brakes.

If you make no extreme correction with the steering or brakes, your vehicle and trailer should stabilize. (if enabled, Trailer Sway Control can also help to stabilize the vehicle and trailer.)

- After the trailer swaying has stopped:
  - Stop in a safe place. Get all occupants out of the vehicle.
  - Check the tires of the vehicle and the trailer.
  - Check the load in the trailer.
    - Make sure the load has not shifted.
    - Make sure the tongue weight is appropriate, if possible.
  - Check the load in the vehicle.
    - Make sure the vehicle is not overloaded after occupants get in.

If you cannot find any problems, the speed at which trailer swaying occurred is beyond the limit of your particular vehicle-trailer combination. Drive at a lower speed to prevent instability. Remember that swaying of the towing vehicle-trailer increases as speed increases.

#### CAUTION

##### ■ Trailer towing precautions

To tow a trailer safely, use extreme care and drive the vehicle in accordance with the trailer's characteristics and operating conditions. Failure to do so could cause an accident resulting in death or serious injury. Vehicle stability and braking performance are affected by trailer stability, brake setting and performance, and the hitch. Your vehicle will handle differently when towing a trailer.

##### ■ To avoid accident or injury

- Do not exceed the TWR, unbraked TWR, GCWR, GVWR or GAWR.
- If the gross trailer weight is over 2000 lb. (907 kg), a sway control device with sufficient capacity is required.
- Adjust the tongue weight within the appropriate range. Place heavier loads as close to the trailer axle as possible.
- Do not exceed 65 mph (104 km/h), the posted towing speed limit or the speed limit for your trailer as set forth in your trailer owner's manual, whichever is lowest. Slow down sufficiently before making a turn, in cross winds, on wet or slippery surface, etc. to help avoid an accident. If you experience a vehicle-trailer instability from reducing a certain speed, slow down and make sure you keep your vehicle speed under the speed of which you experience the instability.
- Do not make jerky, abrupt or sharp turns.

 CAUTION

- Do not apply the brakes suddenly as you may skid, resulting in jackknifing and loss of vehicle control. This is especially true on wet or slippery surfaces.
- Do not exceed the trailer hitch assembly weight, gross vehicle weight, gross axle weight and trailer tongue weight capacities.
- Do not use cruise control when towing.
- Slow down and downshift before descending steep or long downhill grades. Do not make sudden downshifts while descending steep or long downhill grades.
- Vehicle-trailer instability is more likely on steep long downhills. Before descending steep or long downhill grades, slow down and downshift. Do not make sudden downshifts when descending steep or long downhill grades. Avoid holding the brake pedal down too long or applying the brakes too frequently. This could cause the brakes to overheat and result in reduced braking efficiency.

■ **Hitch**

Trailer hitch assemblies have different weight capacities established by the hitch manufacturer. Even though the vehicle may be physically capable of towing a higher weight, the operator must determine the maximum weight rating of the particular hitch assembly and never exceed the maximum weight rating specified for the trailer-hitch. Exceeding the maximum weight rating set by the trailer-hitch manufacturer can cause an accident resulting in death or serious personal injuries.

■ **When towing a trailer**

Toyota recommends trailers with brakes that conform to any applicable federal and state/provincial regulations.

- If the gross trailer weight exceeds unbraked TWR, trailer brakes are required. Toyota recommends trailers with brakes that conform to all applicable federal and state/provincial regulations.
- Never tap into your vehicle's hydraulic system, as this will lower the vehicle's braking effectiveness.
- Never tow a trailer without using a safety chain securely attached to both the trailer and the vehicle. If damage occurs to the coupling unit or hitch ball, there is danger of the trailer wandering into another lane.

 NOTICE■ **When installing a trailer hitch**

Use only the position recommended by your Toyota dealer. Do not install the trailer hitch on the bumper; this may cause body damage.

■ **Do not directly splice trailer lights**

Do not directly splice trailer lights. Directly splicing trailer lights may damage your vehicle's electrical system and cause a malfunction.

## Dinghy towing

Your vehicle is not designed to be dinghy towed (with 4 wheels on the ground) behind a motor home.

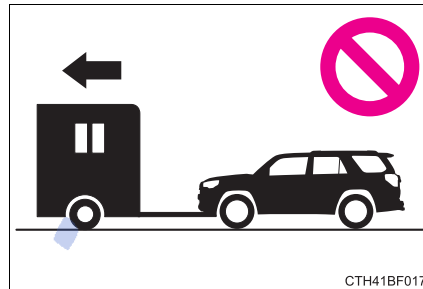

 NOTICE

- **To avoid serious damage to your vehicle**  
Do not tow your vehicle with the four wheels on the ground.

4

Driving

تلفن شبانه روزی: ۰۲۱-۸۸۶۲۰۸۵

FarmaSOS.com

## Engine (ignition) switch (vehicles without a smart key system)

### Starting the engine

- 1 Check that the parking brake is set.
- 2 Check that the shift lever is set in P.
- 3 Firmly depress the brake pedal.
- 4 Turn the engine switch to the "START" position to start the engine.

### Changing the engine switch positions

- ① "LOCK"  
The steering wheel is locked and the key can be removed. (The key can be removed only when the shift lever is in P.)
- ② "ACC"  
Some electrical components such as the audio system can be used.
- ③ "ON"  
All electrical components can be used.
- ④ "START"  
For starting the engine.

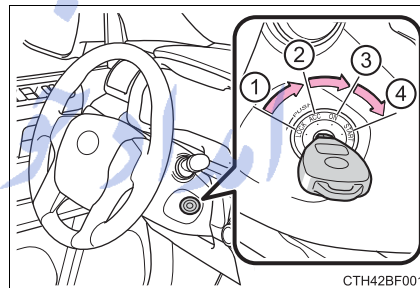

تلفن شبانه روزی: ۰۲۱-۸۸۶۲۰۸۵  
FarmaSOS.com

**■ Turning the key from “ACC” to “LOCK”**

- 1 Shift the shift lever to P.
- 2 Push in the key and turn to the “LOCK” position.

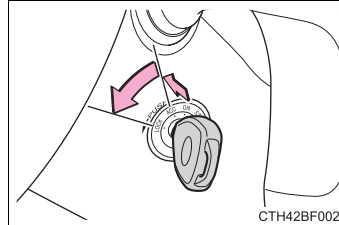
**■ If the engine does not start**

The engine immobilizer system may not have been deactivated. (→P. 70)  
Contact your Toyota dealer.

**■ When the steering lock cannot be released**

When starting the engine, the engine switch may seem stuck in the “LOCK” position. To free it, turn the key while turning the steering wheel slightly left and right.

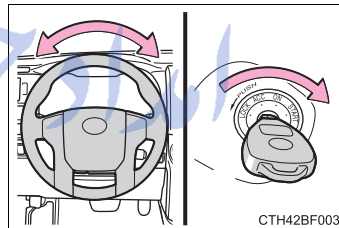
**■ Key reminder function**

A buzzer sounds if the driver's door is opened, while the engine switch is in the “LOCK” or “ACC” position to remind you to remove the key.

 CAUTION**■ When starting the engine**

Always start the engine while sitting in the driver's seat. Do not depress the accelerator pedal while starting the engine under any circumstances. Doing so may cause an accident resulting in death or serious injury.

**■ Caution when driving**

Do not turn the engine switch to the "LOCK" position while driving. If, in an emergency, you must turn the engine off while the vehicle is moving, turn the engine switch only to the "ACC" position to stop the engine. An accident may result if the engine is stopped while driving.

 NOTICE**■ To prevent battery discharge**

Do not leave the engine switch in the "ACC" or "ON" position for long periods of time without the engine running.

**■ When starting the engine**

- Do not crank the engine for more than 30 seconds at a time. This may overheat the starter and wiring systems.
- Do not race a cold engine.
- If the engine becomes difficult to start or stalls frequently, have the engine checked immediately.

FarmaSOS.com



## Engine (ignition) switch (vehicles with a smart key system)

Performing the following operations when carrying the electronic key on your person starts the engine or changes engine switch modes.

### Starting the engine

- 1 Check that the parking brake is set.
- 2 Check that the shift lever is set in P.
- 3 Firmly depress the brake pedal.

The engine switch indicator will turn green. If the indicator does not turn green, the engine cannot be started.

- 4 Press the engine switch.

The engine will crank until it starts or for up to 30 seconds, whichever is less.

Continue depressing the brake pedal until the engine is completely started.

The engine can be started from any engine switch mode.

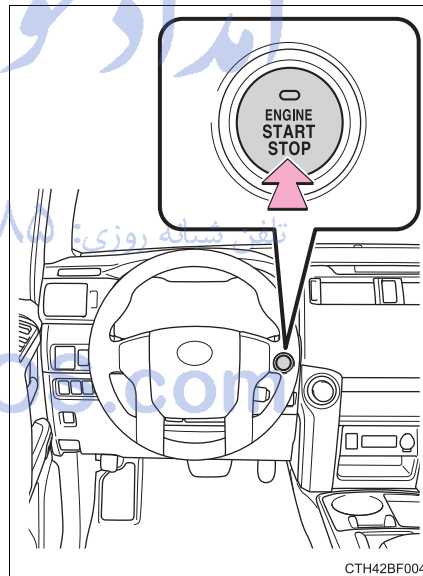

### Stopping the engine

- 1 Stop the vehicle.
- 2 Shift the shift lever to P.
- 3 Set the parking brake. (→P. 204)
- 4 Press the engine switch.
- 5 Release the brake pedal and check that the indicator on the engine switch is off.

### Changing engine switch modes

Modes can be changed by pressing the engine switch with brake pedal released. (The mode changes each time the switch is pressed.)

- ① Off\*
  - The emergency flashers can be used.
  - The engine switch indicator turns amber.
- ② ACCESSORY mode
  - Some electrical components such as the audio system can be used.
  - The engine switch indicator turns amber.
- ③ IGNITION ON mode
  - All electrical components can be used.

\*: If the shift lever is in a position other than P when turning off the engine, the engine switch will be turned to ACCESSORY mode, not to off.

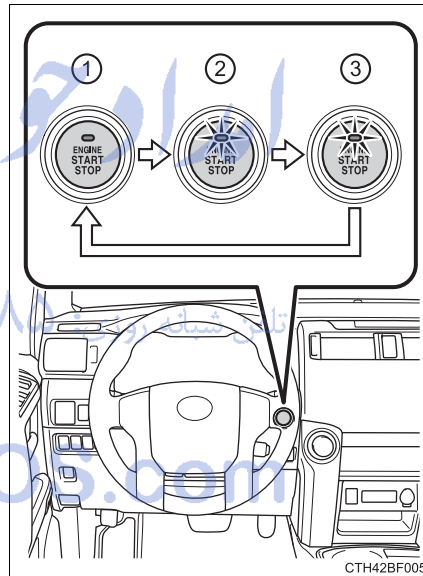

### When stopping the engine with the shift lever in a position other than P

If the engine is stopped with the shift lever in a position other than P, the engine switch will not be turned off but instead be turned to ACCESSORY mode. Perform the following procedure to turn the switch off:

- 1 Check that the parking brake is set.
- 2 Shift the shift lever to P.
- 3 Check that the indicator on the engine switch is illuminated in amber and then press the engine switch once.
- 4 Check that the indicator on the engine switch is off.

#### ■ Auto power off function

If the vehicle is left in ACCESSORY mode for more than 20 minutes or IGNITION ON mode (the engine is not running) for more than an hour with the shift lever in P, the engine switch will automatically turn off. However, this function cannot entirely prevent battery discharge. Do not leave the vehicle with the engine switch in ACCESSORY or IGNITION ON mode for long periods of time when the engine is not running.

#### ■ Electronic key battery depletion

→P. 97

#### ■ Conditions affecting operation

→P. 110

#### ■ Notes for the entry function

→P. 111

#### ■ If the engine does not start

The engine immobilizer system may not have been deactivated. (→P. 70)  
Contact your Toyota dealer.

#### ■ Steering lock

After turning the engine switch off and opening and closing the doors, the steering wheel will be locked due to the steering lock function. Operating the engine switch again automatically cancels the steering lock.

### ■ When the steering lock cannot be released

The green indicator light on the engine switch will flash. Press the engine switch again while turning the steering wheel left and right.

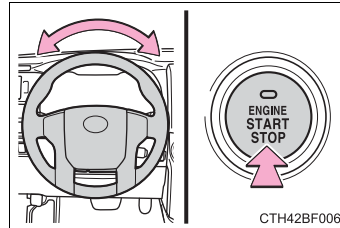

### ■ Steering lock motor overheating prevention

To prevent the steering lock motor from overheating, the motor may be suspended if the engine is turned on and off repeatedly in a short period of time. In this case, refrain from operating the engine. After about 10 seconds, the steering lock motor will resume functioning.

### ■ When the engine switch indicator flashes in amber

The system may be malfunctioning. Have the vehicle inspected by your Toyota dealer immediately.

### ■ If the electronic key battery is depleted

→P. 385

### ■ Operation of the engine switch

When operating the engine switch, one short, firm press is enough. If the switch is pressed improperly, the engine may not start or the engine switch mode may not change. It is not necessary to press and hold the switch.

تلفن شبانه روزی: ۰۲۱-۸۸۶۲۰۸۵

FarmaSOS.com

 CAUTION

■ **When starting the engine**

Always start the engine while sitting in the driver's seat. Do not depress the accelerator pedal while starting the engine under any circumstances. Doing so may cause an accident resulting in death or serious injury.

■ **Caution while driving**

If engine failure occurs while the vehicle is moving, do not lock or open the doors until the vehicle reaches a safe and complete stop. Activation of the steering lock in this circumstance may lead to an accident, resulting in death or serious injury.

■ **Stopping the engine in an emergency**

If you want to stop the engine in an emergency while driving the vehicle, press and hold the engine switch for more than 2 seconds, or press it briefly 3 times or more in succession. (→P. 409)

However, do not touch the engine switch while driving except in an emergency. Turning the engine off while driving will not cause loss of steering or braking control, but the power assist to these systems will be lost. This will make it more difficult to steer and brake, so you should pull over and stop the vehicle as soon as it is safe to do so.

 NOTICE

■ **To prevent battery discharge**

Do not leave the engine switch in ACCESSORY or IGNITION ON mode for long periods of time without the engine running.

■ **When starting the engine**

- Do not race a cold engine.
- If the engine becomes difficult to start or stalls frequently, have your vehicle checked by your Toyota dealer immediately.

## Automatic transmission

### Shifting the shift lever

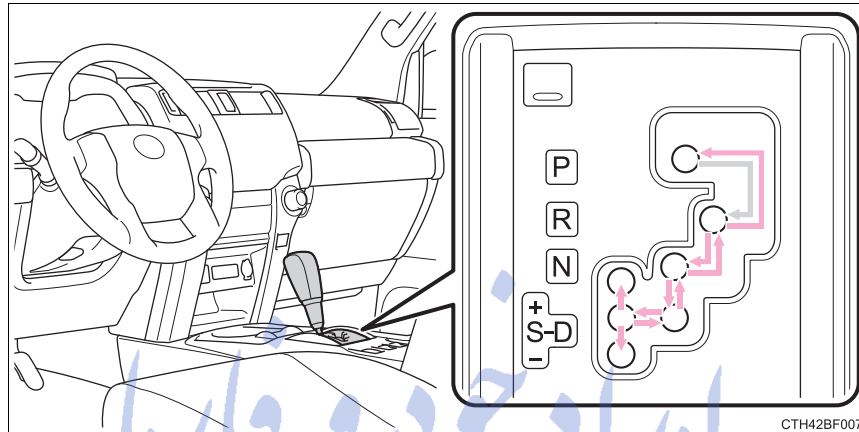

▶ Vehicles without a smart key system

- ← While the engine switch is in the “ON” position, move the shift lever with the brake pedal depressed.

When shifting the shift lever between P and D, make sure that the vehicle is completely stopped.

▶ Vehicles with a smart key system

- ← While the engine switch is in IGNITION ON mode, move the shift lever with the brake pedal depressed.

When shifting the shift lever between P and D, make sure that the vehicle is completely stopped.

### Shift position purpose

Shift position	Objective or function
P	Parking the vehicle/starting the engine
R	Reversing
N	Neutral
D	Normal driving*1
S	S mode driving*2 (→P. 201)

\*1: To improve fuel efficiency and reduce noises, set the shift lever in the D position for normal driving.

\*2: Selecting shift ranges using S mode restricts the upper limit of the possible gear ranges, controls engine braking forces, and prevents unnecessary upshifting

### Changing shift ranges in S mode

When the shift lever is in the S position, the shift lever can be operated as follows:

- ① Upshifting
- ② Downshifting

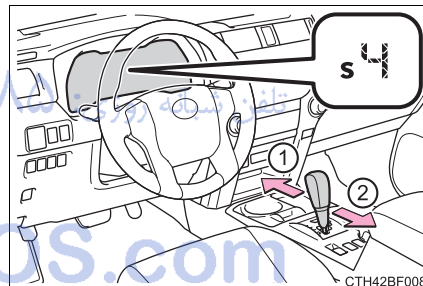

The initial shift range in S mode is set automatically to “4” according to vehicle speed. However, the initial shift range may be set to “3” if AI-SHIFT has operated while the shift lever was in the D position.

(→P. 202)

#### ■ Shift ranges and their functions

You can choose from 5 levels of engine braking force.

A lower shift range will provide greater engine braking force than a higher shift range, and the engine speed will also increase.

### ■ S mode

When the shift range is “3” or lower, holding the shift lever toward “+” sets the shift range to “5”.

### ■ AI-SHIFT

AI-SHIFT automatically selects the optimal gear according to driver performance and driving conditions.

AI-SHIFT automatically operates when the shift lever is in the D position. (Shifting the shift lever to the S position or paddle shifting cancels the function.)

The engine speed may remain high after releasing the accelerator pedal. This does not indicate a malfunction.

### ■ When driving with cruise control system

Engine braking will not occur in S mode, even when downshifting to “4”.  
(→P. 222)

### ■ If the shift lever cannot be shifted from P

→P. 448

### ■ If the “S” indicator does not come on even after shifting the shift lever to S

This may indicate a malfunction in the automatic transmission system. Have the vehicle inspected by your Toyota dealer immediately.

(In this situation, the transmission will operate in the same manner as when the shift lever is in D.)

### ■ Downshift restriction warning buzzer (S mode)

To help ensure safety and driving performance, downshifting operation may sometimes be restricted. In some circumstances, downshifting may not be possible even when the shift lever is operated. (A buzzer will sound twice.)

### ⚠ CAUTION

#### ■ When driving on slippery road surfaces

Be careful of downshifting and sudden acceleration, as this could result in the vehicle skidding to the side or spinning.



## Turn signal lever

### Operating instructions

The lever will return to its original position after operation.

- ① Right turn
- ② Lane change to the right (push and hold the lever partway)
 

The right hand signals will flash until you release the lever.
- ③ Lane change to the left (push and hold the lever partway)
 

The left hand signals will flash until you release the lever.
- ④ Left turn

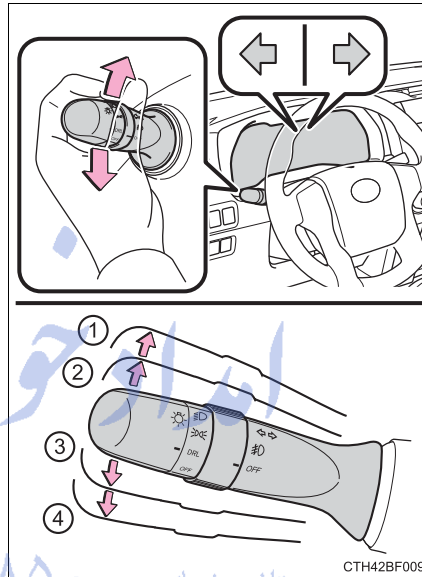

#### ■ Turn signals can be operated when

- ▶ Vehicles without a smart key system  
The engine switch is in the "ON" position.
- ▶ Vehicles with a smart key system  
The engine switch is in IGNITION ON mode.

#### ■ If the indicator flashes faster than usual

Check that a light bulb in the front or rear turn signal lights has not burned out.

## Parking brake

To set the parking brake, fully depress the parking brake pedal with your left foot while depressing the brake pedal with your right foot.

(Depressing the pedal again releases the parking brake.)

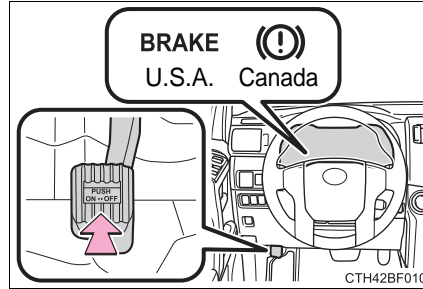

### ■ Usage in winter time

→P. 270

#### ⚠ NOTICE

#### ■ Before driving

Fully release the parking brake.

Driving the vehicle with the parking brake set will lead to brake components overheating, which may affect braking performance and increase brake wear.

تلفن شبانه روزی: ۰۲۱-۸۸۸۶۲۰۸۵

FarmaSOS.com



## Headlight switch

The headlights can be operated manually or automatically.

### Operating instructions

Turning the end of the lever turns on the lights as follows:

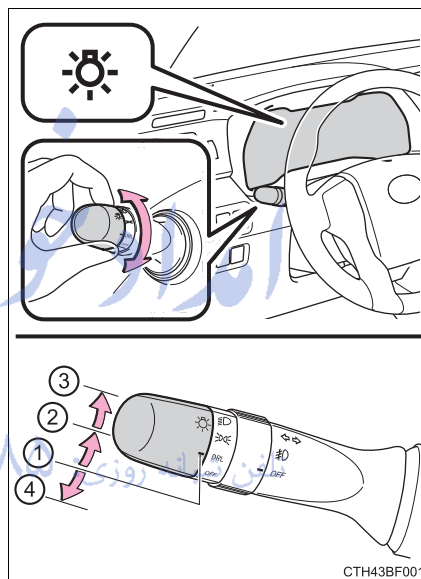

► Type A

- ① **DRL** The daytime running lights turn on.
- ②  The side marker, parking, tail, license plate, daytime running lights and instrument panel lights turn on.
- ③  The headlights and all the lights listed above (except daytime running lights) turn on.
- ④ **OFF** The daytime running lights turn off.



CTH43BF001

## ► Type B

- ① **AUTO** The headlights, parking lights, daytime running lights and so on turn on and off automatically (when the engine switch is in IGNITION ON mode).
- ②  The side marker, parking, tail, license plate, daytime running lights and instrument panel lights turn on.
- ③  The headlights and all the lights listed above (except daytime running lights) turn on.
- ④  The daytime running lights turn off.

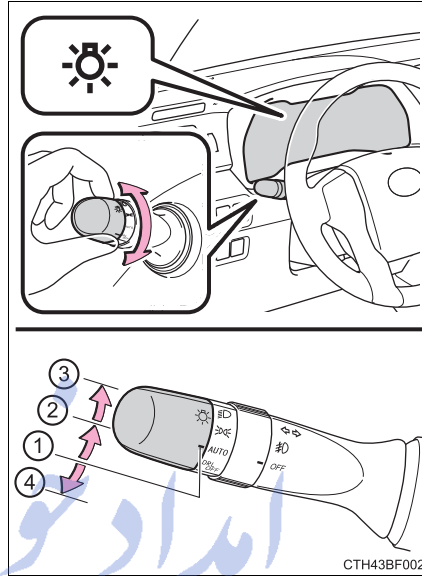

تلفن شبانه روزی: ۰۲۱-۸۸۸۶۲۰۸۵

FarmaSOS.com

## ► Type C

- ① ○ The daytime running lights turn on.
- ② ≡D≡ The side marker, parking, tail, license plate, daytime running lights and instrument panel lights turn on.
- ③ ≡D The headlights and all the lights listed above (except daytime running lights) turn on.

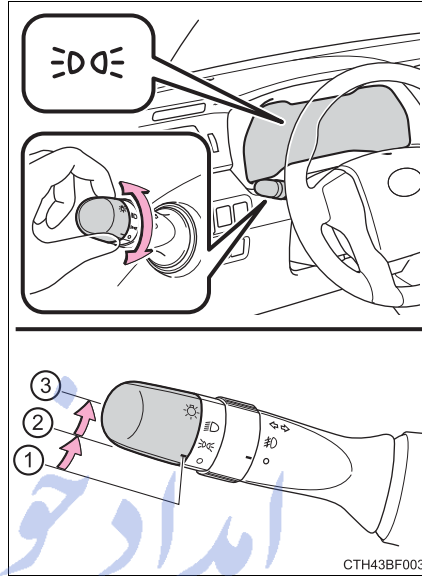

امداد خودرو فارما



4

Driving

تلفن شبانه روزی: ۰۲۱-۸۸۸۶۲۰۸۵

FarmaSOS.com

## ► Type D

- ① **AUTO** The headlights, parking lights, daytime running lights and so on turn on and off automatically (when the engine switch is in IGNITION ON mode).
- ②  The side marker, parking, tail, license plate, daytime running lights and instrument panel lights turn on.
- ③  The headlights and all the lights listed above (except daytime running lights) turn on.
- ④  The daytime running lights turn on.

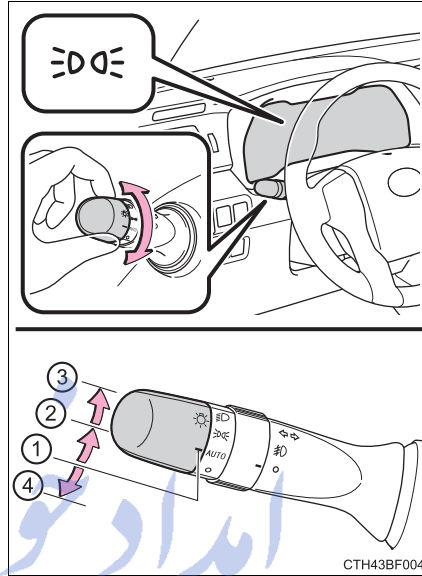
**Turning on the high beam headlights**

- ① With the headlights on, push the lever away from you to turn on the high beams.  
Pull the lever toward you to the center position to turn the high beams off.
- ② Pull the lever toward you and release it to flash the high beams once.

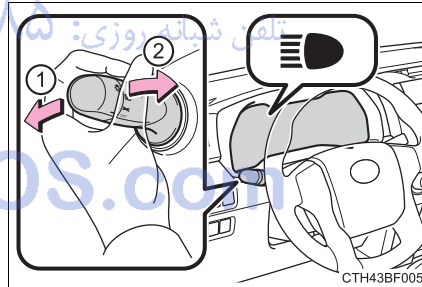

You can flash the high beams with the headlights on or off.

### ■ Daytime running light system

- To make your vehicle more visible to other drivers, the headlight high beam turn on automatically (at a decreased intensity) whenever the engine is started and the parking brake is released. Daytime running lights are not designed for use at night.

Type A and B: Daytime running lights can be turned off by operating the switch.

- Compared to turning on the headlights, the daytime running light system offers greater durability and consumes less electricity, so it can help improve fuel economy.

### ■ Headlight control sensor (if equipped)

The sensor may not function properly if an object is placed on the sensor, or anything that blocks the sensor is affixed to the windshield.

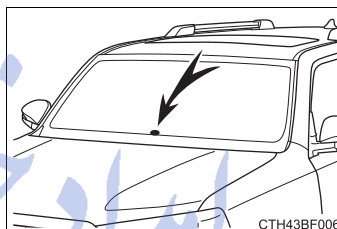

Doing so interferes with the sensor detecting the level of ambient light and may cause the automatic headlight system to malfunction.



### ■ Automatic light off system



#### ▶ Vehicles without a smart key system

- When the headlights come on: The headlights and tail lights turn off 30 seconds after a door is opened and closed if the engine switch is turned to the "ACC" or "LOCK" position. (The lights turn off immediately if  on the key is pressed after all the doors are locked.)
- When only the tail lights come on: The tail lights turn off automatically if the engine switch is turned to the "ACC" or "LOCK" position and the driver's door is opened.

To turn the lights on again, turn the engine switch to the "ON" position, or turn the lights off and then back to  or .

#### ▶ Vehicles with a smart key system

- When the headlights come on: The headlights and tail lights turn off 30 seconds after a door is opened and closed if the engine switch is turned to ACCESSORY mode or turned off. (The lights turn off immediately if  on the key is pressed after all the doors are locked.)
- When only the tail lights come on: The tail lights turn off automatically if the engine switch is turned off and the driver's door is opened.

To turn the lights on again, turn the engine switch to IGNITION ON mode, or turn the light switch off and then back to  or .

### ■ Customization

Settings (e.g. light sensor sensitivity) can be changed.  
(Customizable features: →P. 485)

 NOTICE

■ **To prevent battery discharge**

Do not leave the lights on longer than necessary when the engine is not running.

امداد خودرو فارما

تلفن شبانه روزی: ۰۲۱-۸۸۸۶۲۰۸۵

FarmaSOS.com



## Fog light switch

The fog lights secure excellent visibility in difficult driving conditions, such as in rain and fog.

► Type A

- ① OFF Turns the front fog lights off
- ②  Turns the front fog lights on

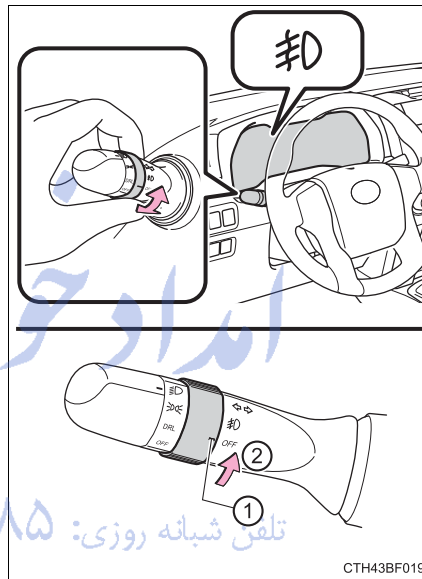

► Type B

- ① ○ Turns the front fog lights off
- ② ㊦ Turns the front fog lights on

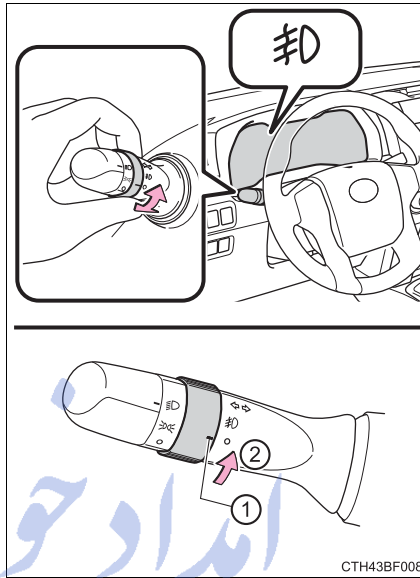

■ Fog lights can be used when

The headlights are on in low beam.

تلفن شبانه روزی: ۰۲۱-۸۸۸۶۲۰۸۵

FarmaSOS.com

## Windshield wipers and washer

### Operating the wiper lever

The wiper operation is selected by moving the lever as follows.

► Type A

Wiper intervals can be adjusted for intermittent operation (when INT is selected).

- ① INT Intermittent windshield wiper operation
- ② LO Low speed windshield wiper operation
- ③ HI High speed windshield wiper operation
- ④ MIST Temporary operation

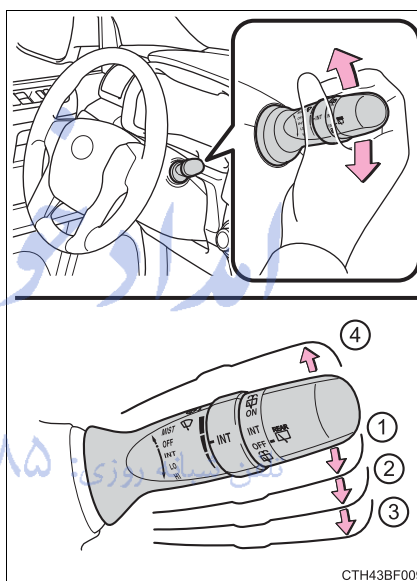



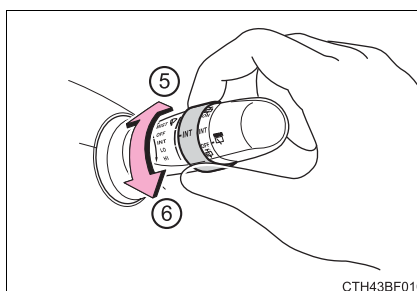

Wiper intervals can be adjusted when intermittent operation is selected.

- ⑤ Increases the intermittent windshield wiper frequency
- ⑥ Decreases the intermittent windshield wiper frequency



► Type B

Wiper intervals can be adjusted for intermittent operation (when  is selected).

- ①  Intermittent windshield wiper operation
- ②  Low speed windshield wiper operation
- ③  High speed windshield wiper operation
- ④  Temporary operation

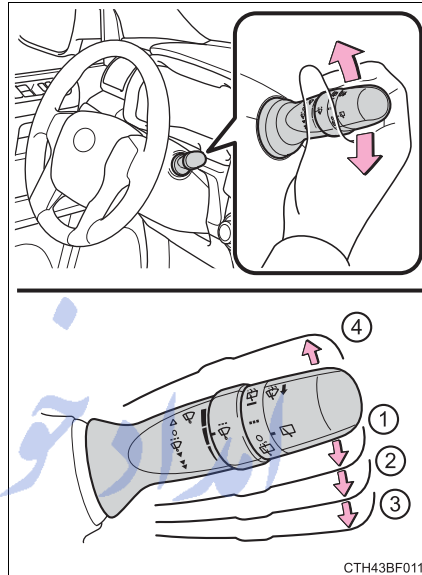

Wiper intervals can be adjusted when intermittent operation is selected.

- ⑤ Increases the intermittent windshield wiper frequency
- ⑥ Decreases the intermittent windshield wiper frequency

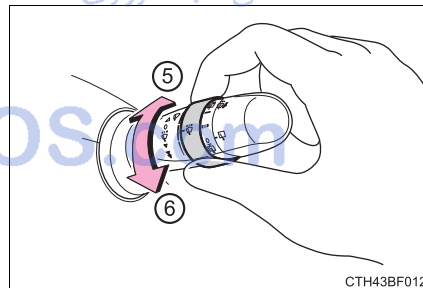

■ Washer/wiper dual operation

Wipers will automatically operate a couple of times after the washer squirts.

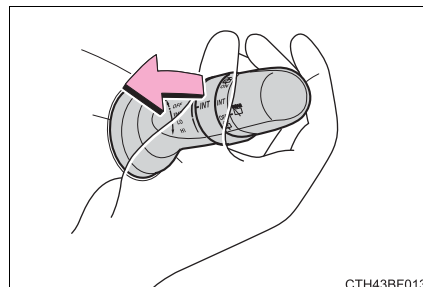

■ **The windshield wiper and washer can be operated when**

- ▶ Vehicles without a smart key system  
The engine switch is in the "ON" position.
- ▶ Vehicles with a smart key system  
The engine switch is in IGNITION ON mode.

■ **If no windshield washer fluid sprays**

Check that the washer nozzles are not blocked if there is washer fluid in the washer fluid reservoir.

 **CAUTION**

■ **Caution regarding the use of washer fluid**

When it is cold, do not use the washer fluid until the windshield becomes warm. The fluid may freeze on the windshield and cause low visibility. This may lead to an accident, resulting in death or serious injury.

 **NOTICE**

■ **When the windshield is dry**

Do not use the wipers, as they may damage the windshield.

■ **When the washer fluid tank is empty**

Do not operate the switch continually as the washer fluid pump may over-heat.

■ **When a nozzle becomes blocked**

In this case, contact your Toyota dealer.  
Do not try to clear it with a pin or other object. The nozzle will be damaged.



## Rear window wiper and washer

**Before operating the rear window wiper and washer switch, make sure the back window is completely closed. (→P. 151)**

### Operating instructions

The wiper operation is selected by moving the lever as follows:

► Type A

- ① **OFF** Off
- ② **INT** Intermittent window wiper operation
- ③ **ON** Normal window wiper operation
- ④  Washer/wiper dual operation
- ⑤  Washer/wiper dual operation

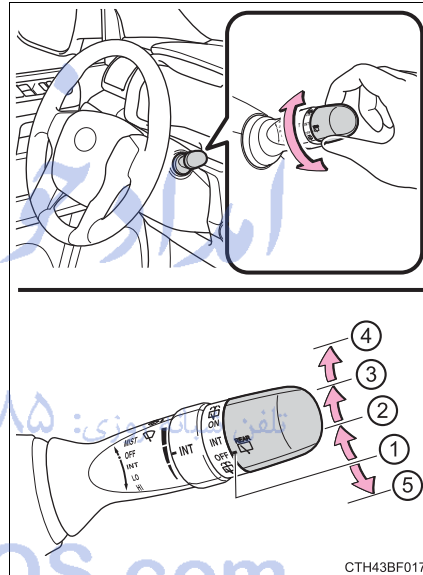

The wiper will automatically operate a couple of times after the washer squirts.

(After operating several times, the wiper operates one more time after a short delay to prevent dripping.)



CTH43BF017

## ► Type B

- ① ○ Off
- ② --- Intermittent window wiper operation
- ③ — Normal window wiper operation
- ④  Washer/wiper dual operation
- ⑤  Washer/wiper dual operation

The wiper will automatically operate a couple of times after the washer squirts.  
(After operating several times, the wiper operates one more time after a short delay to prevent dripping.)

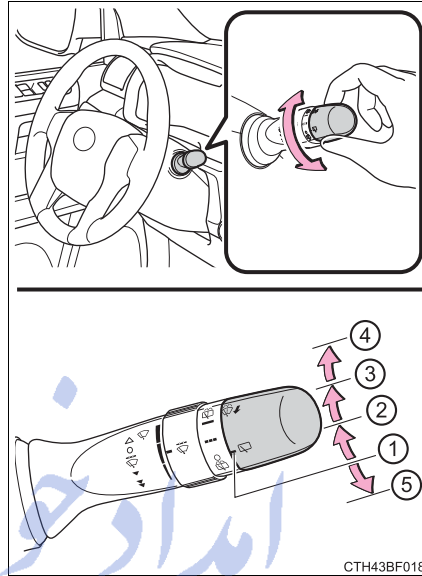

4

Driving

## ■ The rear window wiper and washer can be operated when

- Vehicles without a smart key system: The engine switch is in the "ON" position.
- Vehicles with a smart key system: The engine switch is in IGNITION ON mode.
- The back window is completely closed.

## ■ Intermittent window wiper operation

- When intermittent window wiper operation mode is selected, the wiper will operate a couple of times and then switch to intermittent operation.
- During intermittent operation, the wiper stops temporarily at the reversing position.

■ **When the rear window wiper and washer switch is turned off**

The rear wiper will stop operation, and return to the retracted position after approximately 3 seconds.

However, if the engine switch is turned to the “ACC” or “LOCK” position (vehicles without a smart key system) or the engine switch is turned to ACCESSORY mode or turned off (vehicles with a smart key system) while the rear wiper is operating, the rear wiper will stop at that position and will not return to the retracted position.

■ **If no washer fluid sprays**

Check that the washer nozzle is not blocked if there is washer fluid in the washer fluid reservoir.

■ **Customization**

Settings (e.g. drip prevention function) can be changed.  
(Customizable features →P. 485)

 NOTICE

■ **When the rear window is dry**

Do not use the wiper, as it may damage the rear window.

■ **When the washer fluid tank is empty**

Do not operate the switch continually as the washer fluid pump may overheat.

■ **When a nozzle becomes blocked**

In this case, contact your Toyota dealer.

Do not try to clear it with a pin or other object. The nozzle will be damaged.

FarmaSOS.com



## Opening the fuel tank cap

Perform the following steps to open the fuel tank cap:

### Before refueling the vehicle

- Close all the doors and windows, and turn the engine switch off.
- Confirm the type of fuel.

### Fuel types

Use unleaded gasoline (Octane rating 87 [Research Octane Number 91] or higher)

امداد خودرو فارما

تلفن شبانه روزی: ۰۲۱-۸۸۸۶۲۰۸۵

FarmaSOS.com

 CAUTION

■ **When refueling the vehicle**

Observe the following precautions while refueling the vehicle. Failure to do so may result in death or serious injury.

- After exiting the vehicle and before opening the fuel door, touch an unpainted metal surface to discharge any static electricity. It is important to discharge static electricity before refueling because sparks resulting from static electricity can cause fuel vapors to ignite while refueling.
- Always hold the grips on the fuel tank cap and turn it slowly to remove it. A whooshing sound may be heard when the fuel tank cap is loosened. Wait until the sound cannot be heard before fully removing the cap. In hot weather, pressurized fuel may spray out the filler neck and cause injury.
- Do not allow anyone that has not discharged static electricity from their body to come close to an open fuel tank.
- Do not inhale vaporized fuel. Fuel contains substances that are harmful if inhaled.
- Do not smoke while refueling the vehicle. Doing so may cause the fuel to ignite and cause a fire.
- Do not return to the vehicle or touch any person or object that is statically charged. This may cause static electricity to build up, resulting in a possible ignition hazard.

■ **When refueling**

Observe the following precautions to prevent fuel overflowing from the fuel tank:

- Securely insert the fuel nozzle into the fuel filler neck.
- Stop filling the tank after the fuel nozzle automatically clicks off.
- Do not top off the fuel tank.

 NOTICE

■ **Refueling**

Do not spill fuel during refueling.

Doing so may damage the vehicle, such as causing the emission control system to operate abnormally or damaging fuel system components or the vehicle's painted surface.

### Opening the fuel tank cap

- 1 Open the fuel filler door.

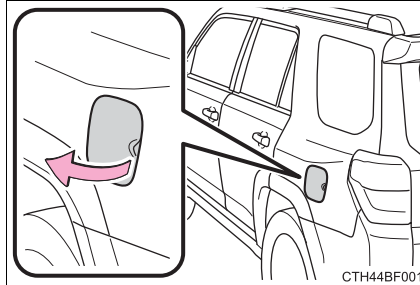

- 2 Turn the fuel tank cap slowly to open. Hang the fuel tank cap on the back of the fuel filler door.

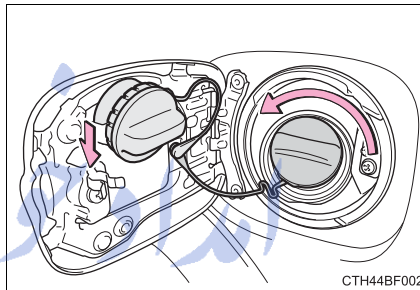

### Closing the fuel tank cap

After refueling, turn the fuel tank cap until you hear a click. Once the cap is released, it will turn slightly in the opposite direction.

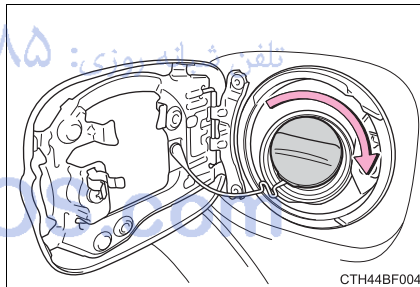

#### ⚠ CAUTION

##### ■ When replacing the fuel tank cap

Do not use anything but a genuine Toyota fuel tank cap designed for your vehicle. Doing so may cause a fire or other incident which may result in death or serious injury.

## Cruise control

### Summary of functions

Use the cruise control to maintain a set speed without depressing the accelerator pedal.

- ① Indicators
- ② Cruise control switch

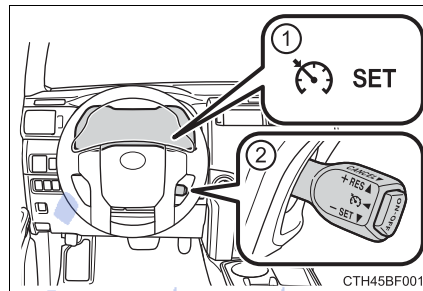

### Setting the vehicle speed

- 1 Press the "ON-OFF" button to activate the cruise control.  
Cruise control indicator will come on.  
Press the button again to deactivate the cruise control.

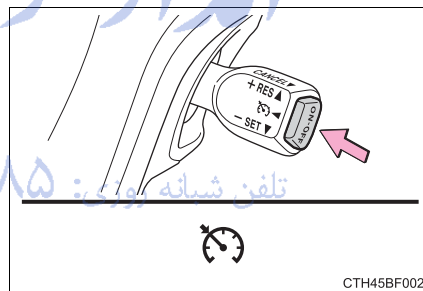

- 2 Accelerate or decelerate the vehicle to the desired speed, and push the lever down to set the speed.  
"SET" indicator will come on.  
The vehicle speed at the moment the lever is released becomes the set speed.

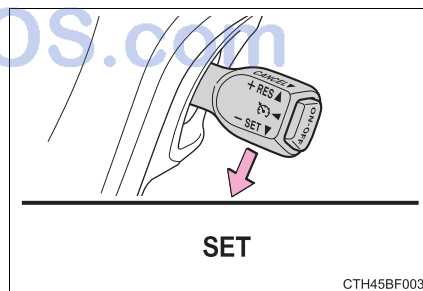

### Adjusting the set speed

To change the set speed, operate the lever until the desired set speed is obtained.

- ① Increases the speed
- ② Decreases the speed

Fine adjustment: Momentarily move the lever in the desired direction.

Large adjustment: Hold the lever in the desired direction.

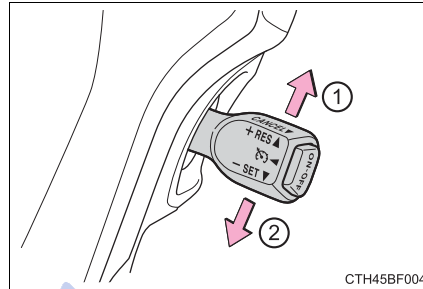

CTH45BF004

The set speed will be increased or decreased as follows:

Fine adjustment: By approximately 1 mph (1.6 km/h) each time the lever is operated.

Large adjustment: The set speed can be increased or decreased continually until the lever is released.

### Canceling and resuming the constant speed control

- ① Pulling the lever toward you cancels the constant speed control.

The speed setting is also canceled when the brakes are applied.

- ② Pushing the lever up resumes the constant speed control.

Resuming is available when the vehicle speed is more than approximately 25 mph (40 km/h).

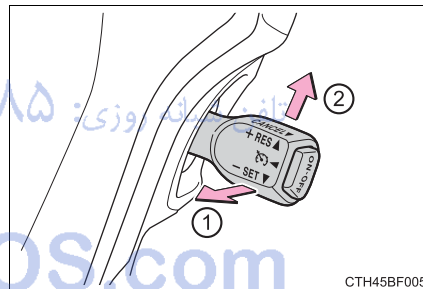

CTH45BF005

**■ Cruise control can be set when**

- The shift lever is in D or range 4 or higher of S has been selected.
- Vehicle speed is above approximately 25 mph (40 km/h).

**■ Accelerating after setting the vehicle speed**

- The vehicle can be accelerated normally. After acceleration, the set speed resumes.
- Even without canceling the cruise control, the set speed can be increased by first accelerating the vehicle to the desired speed and then pushing the lever down to set the new speed.

**■ Automatic cruise control cancelation**

Cruise control will stop maintaining the vehicle speed in any of the following situations.

- Actual vehicle speed falls more than approximately 10 mph (16 km/h) below the preset vehicle speed.  
At this time, the memorized set speed is not retained.
- Actual vehicle speed is below approximately 25 mph (40 km/h).
- VSC is activated.
- The operation cannot be switched for 5 seconds or more after operating the front-wheel drive control switch (part-time 4WD models) or the four-wheel drive control switch (full-time 4WD models).

**■ If the cruise control indicator light flashes**

Press the "ON-OFF" button once to deactivate the system, and then press the button again to reactivate the system.

If the cruise control speed cannot be set or if the cruise control cancels immediately after being activated, there may be a malfunction in the cruise control system. Have the vehicle inspected by your Toyota dealer.

FarmaSOS.com

 CAUTION**■ To avoid operating the cruise control by mistake**

Switch the cruise control off using the "ON-OFF" button when not in use.

**■ Situations unsuitable for cruise control**

Do not use cruise control in any of the following situations.

Doing so may result in loss of control and could cause an accident resulting in death or serious injury.

- In heavy traffic
- On roads with sharp bends
- On winding roads
- On slippery roads, such as those covered with rain, ice or snow
- On steep hills  
Vehicle speed may exceed the set speed when driving down a steep hill.
- When your vehicle is towing a trailer or during emergency towing

امداد خودرو فارما  
تلفن شبانه روزی: ۰۲۱-۸۸۶۲۰۸۵

FarmaSOS.com

## Intuitive parking assist\*

The distance from your vehicle to nearby obstacles when parallel parking or maneuvering into a garage is measured by the sensors and communicated via the multi-information display and a buzzer. Always check the surrounding area when using this system.

### ■ Types of sensors

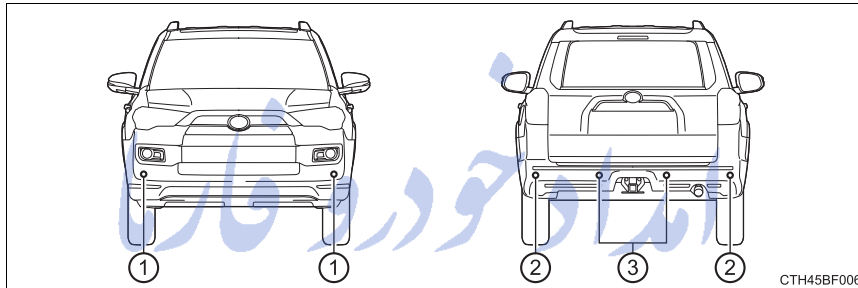

- ① Front corner sensors
- ② Rear corner sensors
- ③ Rear center sensors

### ■ Intuitive parking assist switch

Turns the intuitive parking assist on/off

When on, the indicator light comes on and the buzzer sounds to inform the driver that the system is operational.

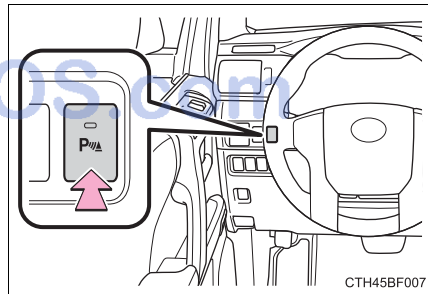

\*: If equipped



### Display

When the sensors detect an obstacle, a graphic is shown on the multi-information display depending on the position and distance to the obstacle.

- ① Front corner sensor operation
- ② Rear corner sensor operation
- ③ Rear center sensor operation



### The distance display and buzzer

When a sensor detects an obstacle, the direction of and the approximate distance to the obstacle are displayed and the buzzer sounds.

#### ► Corner sensors

Distance to an obstacle ft. (cm)	Buzzer
Approximately 2.0 - 1.5 (60 - 45)	Intermittent
Approximately 1.5 - 1.0 (45 - 30)	Fast intermittent
Approximately 1.0 or less (30 or less)	Continuously

#### ► Rear center sensors

Distance to an obstacle ft. (cm)	Buzzer
Approximately 4.9 - 2.0 (150 - 60)	Intermittent
Approximately 2.0 - 1.5 (60 - 45)	Fast intermittent
Approximately 1.5 - 1.2 (45 - 35)	Very fast intermittent
Approximately 1.2 or less (35 or less)	Continuously

### Detection range of the sensors

- ① Approximately 2.0 ft. (60 cm)
- ② Approximately 4.9 ft. (150 cm)

The diagram shows the detection range of the sensors. Note that the sensors cannot detect obstacles that are extremely close to the vehicle.

The range of the sensors may change depending on the shape of the object etc.

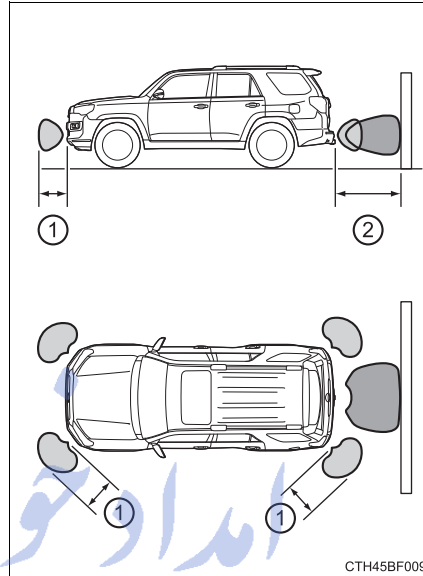

### Intuitive parking assist can be operated when

- Front corner sensors:
  - The engine switch is in the "ON" position (without a smart key system) or the engine switch is in IGNITION ON mode (with a smart key system).
  - The shift lever is in a position other than P.
  - The vehicle speed is less than approximately 6 mph (10 km/h).
- Rear corner and rear center sensors:
  - The engine switch is in the "ON" position (without a smart key system) or the engine switch is in IGNITION ON mode (with a smart key system).
  - The shift lever is in R.

### ■ Sensor detection information

- The sensor's detection areas are limited to the areas around the vehicle's front corner and rear bumpers.
- Certain vehicle conditions and the surrounding environment may affect the ability of the sensor to correctly detect obstacles. Particular instances where this may occur are listed below.
  - There is dirt, snow or ice on the sensor. (Wiping the sensors will resolve this problem.)
  - The sensor is frozen. (Thawing the area will resolve this problem.)

In especially cold weather, if a sensor is frozen the screen may show an abnormal display, or obstacles may not be detected.

- The sensor is covered in any way.
- The vehicle is leaning considerably to one side.
- On an extremely bumpy road, on an incline, on gravel, or on grass.
- The vicinity of the vehicle is noisy due to vehicle horns, motorcycle engines, air brakes of large vehicles, or other loud noises producing ultrasonic waves.
- There is another vehicle equipped with parking assist sensors in the vicinity.
- The sensor is coated with a sheet of spray or heavy rain.
- The vehicle is equipped with a fender pole or wireless antenna.
- Towing eyelet is installed.
- The bumper or sensor receives a strong impact.
- The vehicle is approaching a tall or curved curb.
- In harsh sunlight or intense cold weather.
- The area directly under the bumpers is not detected.
- If obstacles draw too close to the sensor.
- A non-genuine Toyota suspension (lowered suspension etc.) is installed.
- People may not be detected if they are wearing certain types of clothing.

In addition to the examples above, there are instances in which, because of their shape, signs and other objects may be judged by the sensor to be closer than they are.

- The shape of the obstacle may prevent the sensor from detecting it. Pay particular attention to the following obstacles:
  - Wires, fences, ropes, etc.
  - Cotton, snow and other materials that absorb sound waves
  - Sharply-angled objects
  - Low obstacles
  - Tall obstacles with upper sections projecting outwards in the direction of your vehicle

- The following situations may occur during use.
  - Depending on the shape of the obstacle and other factors, the detection distance may shorten, or detection may be impossible.
  - Obstacles may not be detected if they are too close to the sensor.
  - There will be a short delay between obstacle detection and display. Even at slow speeds, there is a possibility that the obstacle will come within the sensor's detection areas before the display is shown and the warning beep sounds.
  - Thin posts or objects lower than the sensor may not be detected for collision when approached, even if they have been detected once.
  - It might be difficult to hear beeps due to the volume of audio system or air flow noise of air conditioning system.

■ **If a message is displayed on the multi-information display**

→P. 426

■ **Customization that can be configured at Toyota dealer**

Settings (e.g. buzzer volume) can be changed.  
(Customizable features →P. 485)

■ **Certification**

- ▶ For vehicles sold in the U.S.A.

This device complies with Part 15 of the FCC Rules. Operation is subject to the following two conditions; (1) This device may not cause harmful interference, and (2) This device must accept any interference received, including interference that may cause undesired operation.

- ▶ For vehicles sold in Canada

This ISM device complies with Canadian ICES-001. تلفن شبانه ۰۰۱-۸۸۰-۸۸۰۰۰۰  
Cet appareil ISM est conforme a la norme NMB-001 du Canada.

FarmaSOS.com

 CAUTION

■ **When using the intuitive parking assist**

Observe the following precautions.

Failing to do so may result in the vehicle being unable to be driven safely and possibly cause an accident.

- Do not use the sensor at speeds in excess of 6 mph (10 km/h).
- The sensors' detection areas and reaction times are limited. When moving forward or reversing, check the areas surrounding the vehicle (especially the sides of the vehicle) for safety, and drive slowly, using the brake to control the vehicle's speed.
- Do not install accessories within the sensors' detection areas.

 NOTICE

■ **When using intuitive parking assist-sensor**

In the following situations, the system may not function correctly due to a sensor malfunction etc. Have the vehicle checked by your Toyota dealer.

- The intuitive parking assist operation display flashes, and a beep sounds when no obstacles are detected.
- If the area around a sensor collides with something, or is subjected to strong impact.
- If the bumper collides with something.
- If the display shows continuously without a beep.
- If a display error occurs, first check the sensor.

If the error occurs even if there is no ice, snow or mud on the sensor, it is likely that the sensor is malfunctioning.

■ **Notes when washing the vehicle**

Do not apply intensive bursts of water or steam to the sensor area.

Doing so may result in the sensor malfunctioning.

## Four-wheel drive system (part-time 4WD models)

**Use the front-wheel drive control lever or switch to select the following transfer modes:**

► Type A

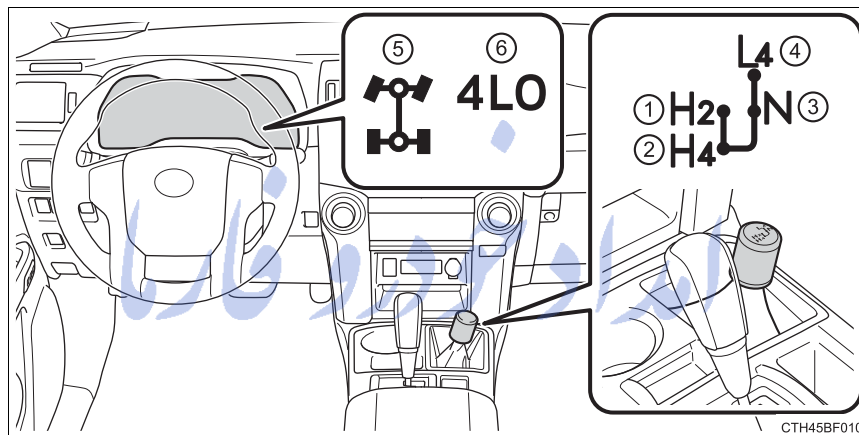

The four-wheel drive indicator comes on when H4, N or L4 mode is selected.

- ① H2 (high speed position, two-wheel drive)  
Use this for normal driving on dry hard-surfaced roads. This position gives greater economy, quietest ride and least wear.
- ② H4 (high speed position, four-wheel drive)  
Use this for driving only on tracks that permit the tires slide, like off-road, icy or snow-covered roads. This position provides greater traction than two-wheel drive.
- ③ N (neutral position)  
No power is delivered to the wheels. The vehicle must be stopped.
- ④ L4 (low speed position, four-wheel drive)  
Use this for maximum power and traction. Use "L4" for climbing or descending steep hills, off-road driving, and hard pulling in sand, mud or deep snow.
- ⑤ Four-wheel drive indicator
- ⑥ Low speed four-wheel drive indicator

## ► Type B

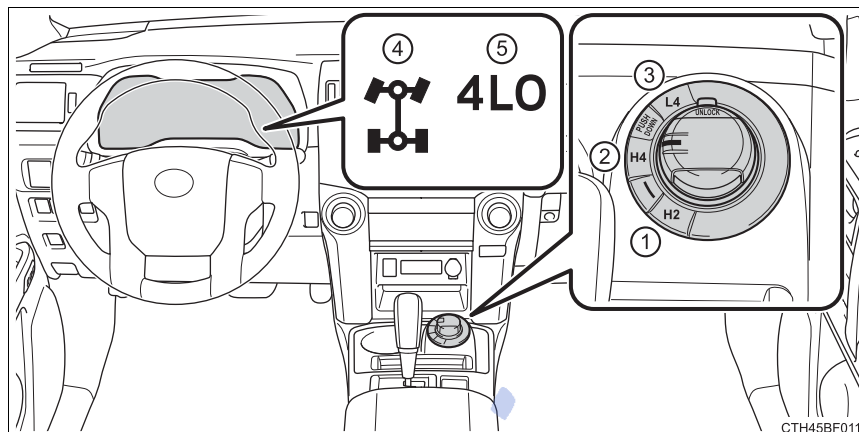

The four-wheel drive indicator comes on when H4 or L4 mode is selected.

## ① H2 (high speed position, two-wheel drive)

Use this for normal driving on dry hard-surfaced roads. This position gives greater economy, quietest ride and least wear.

## ② H4 (high speed position, four-wheel drive)

Use this for driving only on tracks that permit the tires slide, like off-road, icy or snow-covered roads. This position provides greater traction than two-wheel drive.

## ③ L4 (low speed position, four-wheel drive)

Use this for maximum power and traction. Use "L4" for climbing or descending steep hills, off-road driving, and hard pulling in sand, mud or deep snow.

## ④ Four-wheel drive indicator

## ⑤ Low speed four-wheel drive indicator

### Shifting between H2 and H4

#### ■ Shifting from H2 to H4

##### ▶ Type A

- 1 Reduce vehicle speed to less than 50 mph (80 km/h).
- 2 Shift the front-wheel drive control lever to H4.

##### ▶ Type B

- 1 Reduce vehicle speed to less than 62 mph (100 km/h).
- 2 Push the "UNLOCK" button and turn the front-wheel drive control switch to H4.

The four-wheel drive indicator will turn on.

#### ■ Shifting from H4 to H2

##### ▶ Type A

Shift the front-wheel drive control lever to H2.

##### ▶ Type B

Push the "UNLOCK" button and turn the front-wheel drive control switch to H2.

This can be done at any speed.

The four-wheel drive indicator will go off.

### Shifting between H4 and L4

#### ■ Shifting from H4 to L4

- 1 Stop the vehicle completely and continue to depress the brake pedal.
- 2 Shift the shift lever to N.

##### ▶ Type A

- 3 Shift the front-wheel drive control lever to L4.

##### ▶ Type B

- 3 Push the "UNLOCK" button and then push and turn the front-wheel drive control switch to L4.

The low speed four-wheel drive indicator will turn on.



### ■ Shifting from L4 to H4

- 1 Stop the vehicle completely and continue to depress the brake pedal.
- 2 Shift the shift lever to N.
  - ▶ Type A
    - 3 Shift the front-wheel drive control lever to H4.
  - ▶ Type B
    - 3 Push the “UNLOCK” button and turn the front-wheel drive control switch to H4.

The low speed four-wheel drive indicator will go off.

### ■ When the front-wheel drive control lever or switch is shifted to L4

VSC and TRAC are automatically turned off.

### ■ If the four-wheel drive indicator flashes

The transfer mode may not successfully change. Drive straight ahead while accelerating or decelerating, or drive in reverse.

### ■ If the low speed four-wheel drive indicator continues to flash

The transfer mode may not successfully change. Operate the four-wheel drive control switch again.

### ■ If the low speed four-wheel drive indicator continues to flash and a buzzer sounds

The shift lever is not in N and/or the vehicle is moving. Stop the vehicle completely, shift the shift lever to N and make sure that the indicator stops flashing.

### ■ If the four-wheel drive or low speed four-wheel drive indicator flashes rapidly

There may be a malfunction in the four-wheel drive system. Have the vehicle inspected by your Toyota dealer immediately.

### ■ Four-wheel drive usage frequency

You should drive in four-wheel drive for at least 10 miles (16 km) each month. This will assure that the front drive components are lubricated.

### ⚠ CAUTION

#### ■ Shifting the front-wheel drive control lever or switch from H2 to H4 while driving

Never operate the front-wheel drive control lever or switch if the wheels are slipping. Stop the slipping or spinning before shifting.

## Four-wheel drive system (full-time 4WD models)

Use the four-wheel drive control switch to select the following transfer modes:

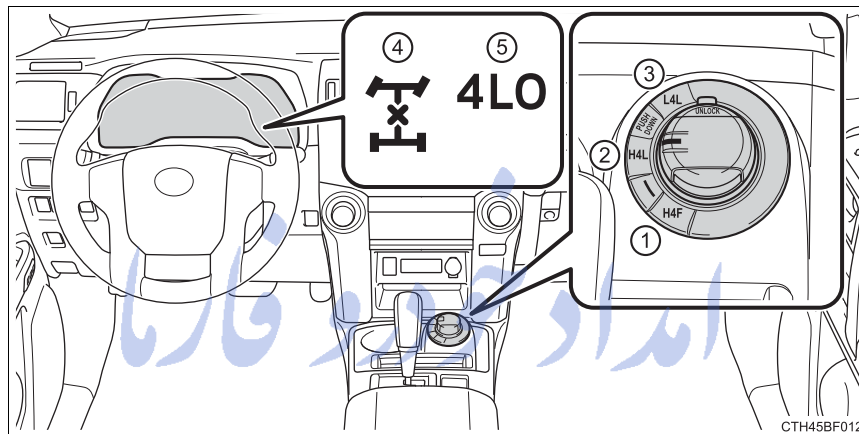

① H4F (high speed position)

Use this for normal driving on dry hard-surfaced roads. This position gives greater economy, quietest ride and least wear.

② H4L (high speed position, center differential locked)

Use this for driving only on tracks that permit the tires slide, like off-road, icy or snow-covered roads.

③ L4L (low speed position, center differential locked)

Use this for maximum power and traction. Use "L4L" for climbing or descending steep hills, off-road driving, and hard pulling in sand, mud or deep snow.

④ Center differential lock indicator

⑤ Low speed four-wheel drive indicator

### Shifting between H4F and H4L

Push the “UNLOCK” button and turn the four-wheel drive control switch to H4L or H4F.

This can be done at any speed.

The center differential lock indicator will turn on (H4L) or go off (H4F).

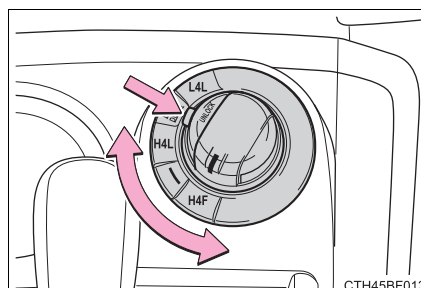

CTH45BF013

### Shifting between H4L and L4L

#### ■ Shifting from H4L to L4L

- 1 Stop the vehicle completely and continue to depress the brake pedal.
- 2 Shift the shift lever to N.
- 3 Push the “UNLOCK” button and then push and turn the four-wheel drive control switch to L4L.

Maintain this condition until the low speed four-wheel drive indicator turns on.

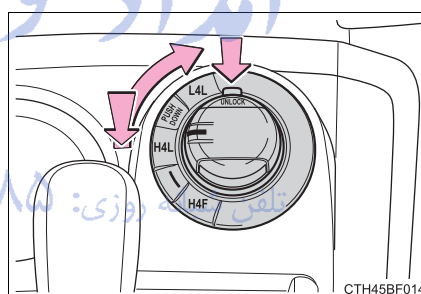

CTH45BF014

■ **Shifting from L4L to H4L**

- 1 Stop the vehicle completely and continue to depress the brake pedal.
- 2 Shift the shift lever to N.
- 3 Push the “UNLOCK” button and turn the four-wheel drive control switch to H4L.

Maintain this condition until the low speed four-wheel drive indicator goes off.

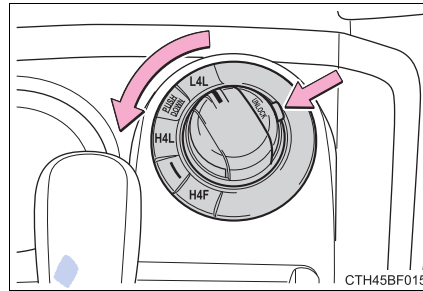

■ **The four-wheel drive control switch can be operated when**

The engine switch is in IGNITION ON mode.

■ **When the four-wheel drive control switch is turned to L4L**

VSC and TRAC are automatically turned off.

■ **If the center differential lock indicator flashes**

Locking or unlocking of the center differential is not complete. Drive straight ahead while accelerating or decelerating, or drive in reverse.

■ **If the center differential lock indicator flashes and a buzzer sounds**

Locking of the center differential is not complete. Stop the wheels from slipping or spinning and, if the indicator still flashes, operate the four-wheel drive control switch again.

■ **If the low speed four-wheel drive indicator continues to flash**

The transfer mode may not successfully change. Operate the four-wheel drive control switch again.

**■ If the low speed four-wheel drive indicator continues to flash and a buzzer sounds**

The shift lever is not in N and/or the vehicle is moving. Stop the vehicle completely, shift the shift lever to N and make sure that the indicator stops flashing.

**■ If the low speed four-wheel drive indicator or the center differential lock indicator flashes rapidly**

There may be a malfunction in the four-wheel drive system. Have the vehicle inspected by your Toyota dealer immediately.

**⚠ CAUTION****■ Operating the four-wheel drive control switch**

Never operate the four-wheel drive control switch if the wheels have lost traction. Doing so may cause an accident resulting in death or serious injury.

Stop the wheels from slipping or spinning before operating the switch.

**⚠ NOTICE****■ To prevent damage to the center differential**

- For normal driving on dry and hard surface roads, unlock the center differential.
- Unlock the center differential after the wheels are out of the ditch or off the slippery or bumpy surface.
- Do not lock or unlock the center differential when the vehicle is turning or when its wheels are spinning freely off the ground.

## Active traction control system\*

The active traction control system automatically helps prevent the spinning of 4 wheels when the vehicle is started or accelerated on slippery road surfaces.

### ■ System operation

- 1 Part-time 4WD models:

Stop the vehicle, shift the shift lever to N and shift the front-wheel drive control lever into L4.

Full-time 4WD models:

Stop the vehicle, shift the shift lever to N and then push and turn the four-wheel drive control switch to L4L.

- 2 Press the “A-TRAC” switch to activate the system.

At this time, the “A-TRAC” indicator will come on.

To cancel the system, push the switch again.

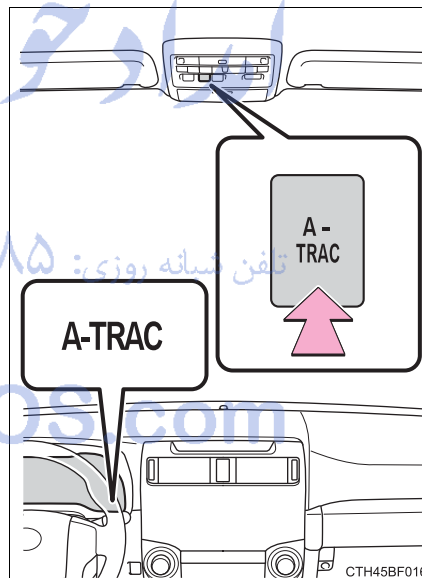

\*: If equipped

### When the active traction control system is operating

If all wheels spin, the slip indicator flashes to indicate that the active traction control system has been engaged.

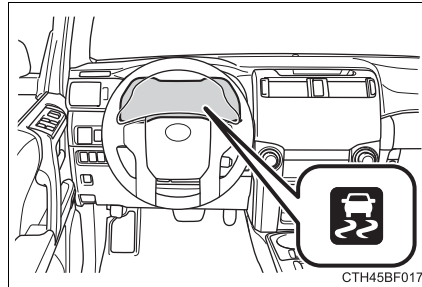

### When the rear differential is locked (vehicles with a rear differential lock system)

The active traction control system is activated only when vehicle speed is less than 4 mph (6 km/h).

### Sounds and vibrations caused by the active traction control system

- A sound may be heard from the engine compartment when the engine is started or just after the vehicle begins to move. This sound does not indicate that a malfunction has occurred in the system.
- Vibrations may be felt through the vehicle body and steering. This may occur when the system is operating.

### If the brake system overheats

The system will cease operation and a buzzer will sound to alert the driver. At this time, the "A-TRAC" indicator will go off and the "TRAC OFF" indicator will come on. Stop the vehicle in a safe place. (There is no problem with continuing normal driving.)

The system will be automatically restored after a short time.

### CAUTION

#### The active traction control system may not operate effectively when

Directional control and power may not be achievable while driving on slippery road surfaces, even if the active traction control system is operating. Do not drive the vehicle in conditions where stability and power may be lost.

## AUTO LSD system (2WD models)

The AUTO LSD system aids traction by using the traction control system to control engine performance and braking when one of the rear wheels begins to spin.

The system should be used only when wheel spinning occurs in a ditch or rough surface.

### ■ System operation

Press the VSC off switch to turn on the system.

At this time, the "AUTO LSD" and VSC off indicators will come on.

To turn off the system, press the switch again.

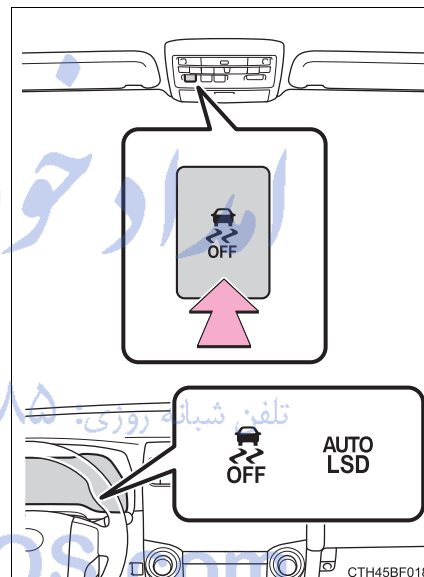



### When the AUTO LSD system is operating

If the rear wheels spin, the slip indicator flashes to indicate that the AUTO LSD system has controlled the spinning of the rear wheels.

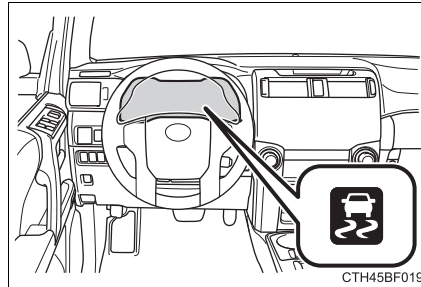

#### ■ If the engine is turned off and restarted

The AUTO LSD system and the indicators are automatically turned off.

#### ■ If the brake system overheats

The system will cease operation and a buzzer will sound to alert the driver. At this time, the "AUTO LSD" indicator will flash and the "TRAC OFF" indicator will come on. Stop the vehicle in a safe place. (There is no problem with continuing normal driving.)

The system will be automatically restored after a short time.

#### ⚠ CAUTION

##### ■ To avoid an accident

- Do not use the AUTO LSD system in conditions other than when wheel spinning occurs in a ditch or rough surfaces.  
A much greater steering effort and more careful cornering control will be required.
- Do not drive with the AUTO LSD system continuously turned on.

#### ⚠ NOTICE

##### ■ Activating while driving

Never activate the AUTO LSD system if the wheel is slipping.  
Stop the slipping or spinning before activating.

## Rear differential lock system\*

**The rear differential lock system is provided for use only when wheel spinning occurs in a ditch or on a slippery or rugged surface.**

The rear differential lock system is effective in case one of the rear wheels is spinning.

Press the switch to lock the rear differential.

At this time, the rear differential lock indicator will flash. Wait a few seconds for the system to complete operation. After the rear differential is locked, the indicator will stop flashing and remain on.

To unlock the rear differential, press the switch again.

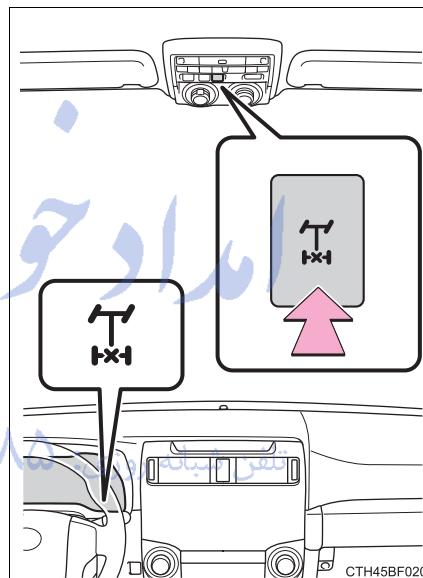

\*: If equipped

### Using the rear differential lock system

- 1 Before using the rear differential lock system:  
Stop the vehicle, shift the shift lever to N and shift the front-wheel drive control lever into L4 to see if this is sufficient. If this has no effect, additionally use the rear differential lock system.
- 2 Be sure the wheels have stopped spinning.
- 3 Press the rear differential lock switch.
- 4 Gently depress the accelerator pedal.

After the rear differential is locked, the indicator will come on.

Unlock the rear differential as soon as the vehicle moves.

To unlock the rear differential, press the switch again.

### Locking the rear differential

The following systems do not operate when the rear differential is locked. It is normal operation for the ABS warning light and VSC OFF indicator to be on at this time.

- ABS
- Multi Terrain ABS
- Brake assist system
- VSC
- Hill-start assist control

### The rear differential lock is disengaged when

The front-wheel drive control lever or switch is shifted to H2 or H4.

Never forget to turn off the switch after using this feature.

### After unlocking the rear differential

Check that the indicator goes off.

### If the rear differential lock indicator flashes rapidly

There may be a malfunction in the rear differential lock system. Have the vehicle inspected by your Toyota dealer immediately.

**⚠ CAUTION****■ To avoid an accident**

- Do not use the rear differential lock system except when wheel spinning occurs in a ditch or on a slippery or rugged surface. Large steering effort and careful cornering control will be required.
- Do not lock the rear differential until the wheels have stopped spinning. Otherwise, the vehicle may move in an unexpected direction when the differential lock is engaged, resulting in an accident. This may also lead to possible damage to rear differential lock component parts.
- Do not drive over 5 mph (8 km/h) when the rear differential is locked.
- Do not keep driving with the rear differential lock switch on.

امداد خودرو فارما

تلفن شبانه روزی: ۰۲۱-۸۸۸۶۲۰۸۵

FarmaSOS.com

## Downhill assist control system\*

**With the downhill assist control system, the vehicle is able to descend a steep hill while maintaining a constant low speed of about 3 mph (5 km/h) without brake pedal operation.**

### ■ Activating the system

The system will activate when

- The vehicle is traveling under 15 mph (25 km/h) with the accelerator and brake pedals released.
- Part-time 4WD models: The front-wheel drive control lever or switch is in L4.
- Full-time 4WD models: The four-wheel drive control switch is in L4L.
- The rear differential is unlocked (if equipped).

Press the “DAC” switch.

The downhill assist control system indicator will come on to indicate that the downhill assist control system is activated.

Pressing the switch again turns the system off.

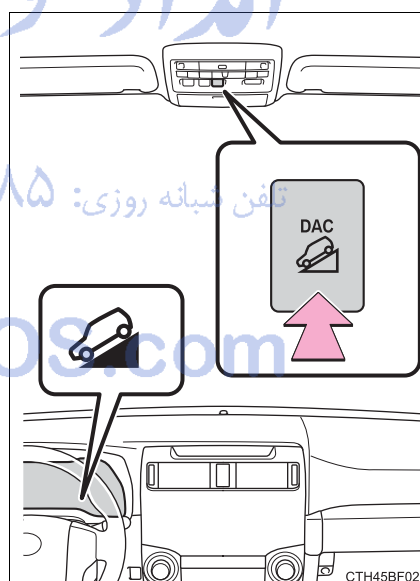

4

Driving

\*: If equipped

### While the downhill assist control system is operating

The slip indicator will flash to indicate that the downhill assist control system is operating, and the stop lights and high mounted spotlight will turn on.

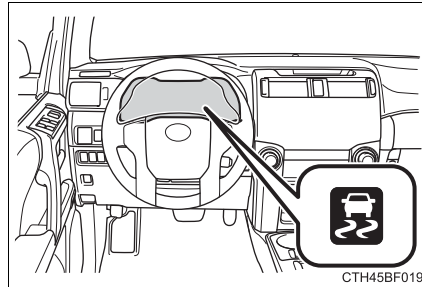

#### ■ Operating tips

The system will operate when the shift lever is in any position other than P. However, to make effective use of the system it is recommended that the shift lever be shifted to the “2” or “1” range of S.

#### ■ If the downhill assist control system indicator flashes

- In the following situations, the indicator flashes and the system will not operate:
  - The transfer mode is not in L4 (part-time 4WD models) or L4L (full-time 4WD models).
  - The rear differential is locked.
  - The brake system overheats.
 

The system will cease operation and a buzzer will sound to alert the driver. At this time, the “TRAC OFF” indicator will come on. Stop the vehicle in a safe place. Refrain from using the system until the indicator stops flashing and stays on. (There is no problem with continuing normal driving.)
- In the following situations, the indicator flashes to alert the driver, but the system will still operate:
  - The shift lever is in N. (Engine braking will not occur.)
  - The “DAC” switch is turned off while the system is operating.
 

The system will gradually cease operation. The indicator will flash during operation, and then go off when the system is fully off.

**■ System malfunction**

In case of a system malfunction, the following may occur:

- The downhill assist control system indicator flashes in a situation other than those listed above.
- The downhill assist control system indicator does not come on when the engine switch is turned to the "ON" position (vehicles without a smart key system) or the engine switch is turned to IGNITION ON mode (vehicles with a smart key system).

Have your vehicle inspected by your Toyota dealer.

**⚠ CAUTION****■ Conditions which may affect the downhill assist control system operation**

- Do not rely too heavily on the downhill assist control system. On extremely steep inclines, icy surfaces or muddy roads, the vehicle may slip and the system may not be able to maintain the constant low vehicle speed of about 3 mph (5 km/h), leading to an accident causing death or serious injury.
- Do not shift the shift lever to R while driving forward, or to D while driving backward. Doing so may cause the wheels to lock up, leading to an accident causing death or serious injury. In addition, excessive stress will be applied to the automatic transmission, possibly resulting in damage.

تلفن شبانه روزی: ۰۲۱-۸۸۶۲۰۸۵

FarmaSOS.com

## Crawl Control\*

Allows travel on extremely rough off-road surfaces at a fixed low speed without pressing the accelerator or brake pedal. Minimizes loss of traction or vehicle slip when driving on slippery road surfaces, allowing for stable driving.

### ■ Crawl Control switch

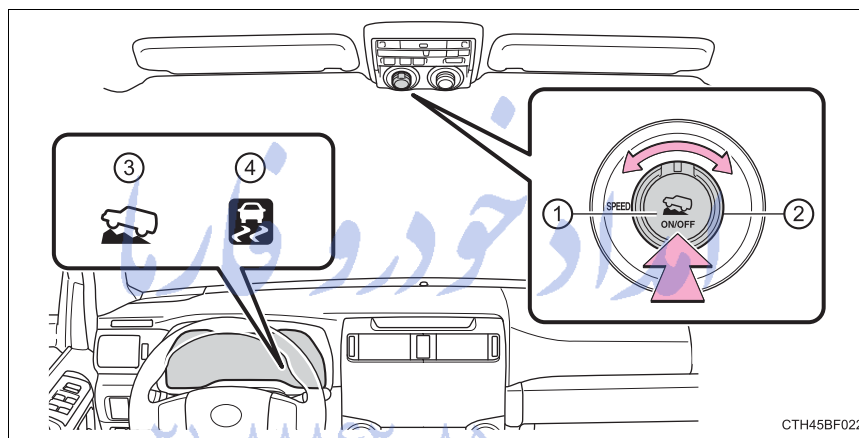

- ① "ON/OFF" switch  
The Crawl Control indicator comes on and the slip indicator flashes when operating.
- ② Speed selector dial  
Turn the dial clockwise to increase the speed and counterclockwise to decrease the speed.
- ③ Crawl Control indicator
- ④ Slip indicator

\*: If equipped



### ■ Speed modes

The following table shows some typical terrains and the recommended speed modes.

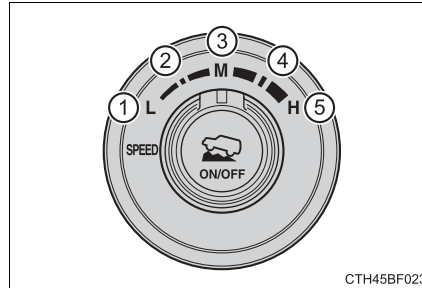

Mode		Road condition
①	L (Low)	Rock, mogul (downhill) and gravel (downhill)
②	Between L and M	Mogul (uphill)
③	M (Medium)	
④	Between M and H	Snow, mud, gravel (uphill), sand, dirt, mogul (uphill) and grass
⑤	H (High)	

### ■ Crawl Control can be operated when

- The engine is running.
- The shift lever is in any position other than P or N.
- The front-wheel drive control lever or switch is in L4.
- The driver's door is closed.

### ■ Crawl Control is temporarily canceled when

Vehicle speed exceeds 15 mph (25 km/h). The Crawl Control indicator flashes until the vehicle speed is reduced.

#### ■ Automatic system cancelation

In the following situations, the system will cease operation and a buzzer will sound to alert the driver. The Crawl Control indicator will flash until the system is turned off completely.

- When the shift lever is shifted to P or N
- When the front-wheel drive control lever or switch is shifted to H4
- When the driver's door is opened
- When the system is malfunctioning
- When the brake system overheats  
Stop the vehicle in a safe place. (There is no problem with continuing normal driving.)
- When the automatic transmission system overheats  
Stop the vehicle in a safe place until the automatic transmission fluid temperature warning light goes off.

#### ■ Sounds and vibrations caused by the Crawl Control system

- A sound may be heard from the engine compartment when the engine is started or just after the vehicle begins to move. This sound does not indicate that a malfunction has occurred in Crawl Control system.
- Either of the following conditions may occur when the Crawl Control system is operating. None of these indicates that a malfunction has occurred.
  - Vibrations may be felt through the vehicle body and steering.
  - A motor sound may be heard after the vehicle comes to a stop.

#### ▲ CAUTION

##### ■ When using Crawl Control

- Do not overly rely on Crawl Control. This function does not extend the vehicle's performance limitations. Always check the terrain thoroughly and drive safely.
- The recommended speed modes for the listed terrains (→P. 251) are only a reference. The selected mode may not be suitable to actual off-road conditions due to factors such as the type or unevenness of the terrain or the degree of incline. Check the actual terrain thoroughly and drive safely.
- After activating Crawl Control, make sure that the Crawl Control indicator comes on. If the indicator flashes, the vehicle is not under system control.

##### ■ Conditions under which the system may not operate correctly

When driving on the following surfaces, the system may not be able to maintain a fixed low speed, which may result in an accident:

- Extremely steep inclines
- Extremely uneven surfaces
- Snow-covered roads, or other slippery surfaces

## Multi-terrain Select\*

The Multi-terrain Select system has 4 terrain modes. When a terrain mode is selected in accordance with terrain conditions, engine power and active traction control system is controlled to enhance off-road drivability.

Additionally, guidance messages such as transfer mode selection advice are displayed on the accessory meter to assist the driver in operating the vehicle.

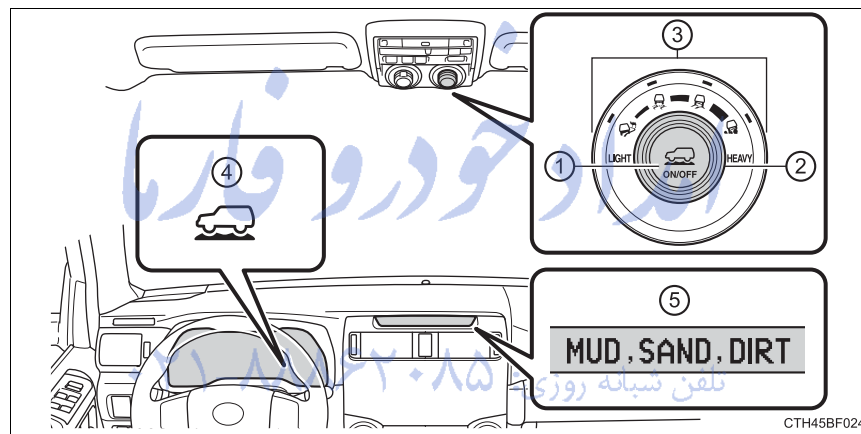

- ① "ON/OFF" switch
- ② Mode selector dial
- ③ Mode indicators
- ④ Multi-terrain Select indicator
- ⑤ Accessory meter

4

Driving

\*: If equipped

■ Multi-terrain Select modes

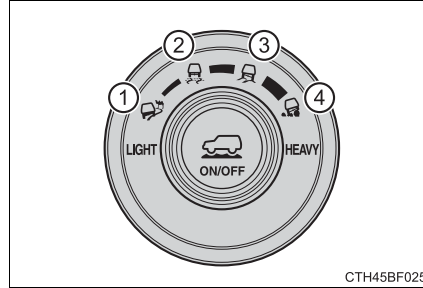

	Symbol	Mode
①		MUD & SAND
②		LOOSE ROCK
③		MOGUL
④		ROCK

تلفن شبانه روزی: ۰۲۱-۸۸۶۲۰۸۵

FarmaSOS.com

The following table shows some typical terrains and the recommended Multi-terrain Select modes.

Mode Road condition	ROCK	MOGUL	LOOSE ROCK	MUD & SAND
Rock	★			
Mogul		★		
Bump, groove		★		
Slope/ V-ditch		★		
Uphill/ downhill		★		
Riverbed			★	
Gravel			★	
Bush			★	
Deep snow				★
Sand				★
Mud				★
Dirt				★

■ **Multi-terrain Select can be activated when**

- Vehicle speed is approximately 7 mph (12 km/h) or less.
- MUD & SAND: The front-wheel drive control lever or switch is in L4 or H4.  
LOOSE ROCK, MOGUL and ROCK: The front-wheel drive control lever or switch is in L4.
- Crawl Control is not operating.

### Selecting modes

- 1 Press the "ON/OFF" switch.

All the mode indicators will come on and then go off except the indicator for the present mode. The applicable road conditions will be displayed on the accessory meter.

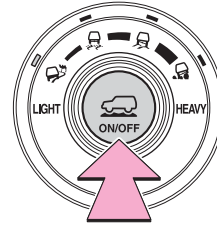

MUD, SAND, DIRT

CTH45BF026

- 2 Turn the dial to select the desired mode.

The indicator of the selected mode will come on and the applicable road conditions will be displayed on the accessory meter.

If the mode indicator flashes, Multi-terrain Select cannot be operated. Follow the instructions displayed on the accessory meter and check that the mode indicator stops flashing. (→P. 257)

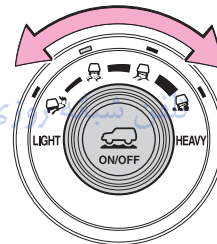

LOOSE ROCK

CTH45BF027

### Messages displayed on the accessory meter

Depending on switch operation, one of the following messages may appear on the accessory meter to provide guidance on transfer mode selection etc:

Message	Details	Procedure
SHIFT TO 4WD (When selecting MUD & SAND mode)	Indicates that the transfer mode needs to be changed to H4 or L4.	Shift the front-wheel drive control lever or switch to H4 or L4.
SHIFT TO L4 (When selecting LOOSE ROCK, MOGUL or ROCK mode)	Indicates that the transfer mode needs to be changed to L4.	Shift the front-wheel drive control lever or switch to L4.
STOP THE VEHICLE & SHIFT THE AUTO. TRANSMISSION TO N (When selecting any mode)	Indicates that the transfer mode cannot be changed to H4 or L4.	Stop the vehicle completely and/or shift the shift lever to N.
ACCELERATE OR DECELERATE (When shifting the front-wheel control lever to H4 or H2)	Indicates that the transfer mode may not successfully change.	Drive straight ahead while accelerating or decelerating, or drive in reverse.
DRIVE THE VEHICLE A SHORT DISTANCE (When pressing the rear differential lock switch)	Indicates that the rear differential is not locked.	Drive the vehicle forward or backward a short distance.
OP. NOT POSSIBLE WHEN Multi-terrain Select ACTIVATED (When pressing the VSC off switch or "A-TRAC" switch)	Indicates that VSC and active traction control cannot be disabled while Multi-terrain Select is operating.	-

Message	Details	Procedure
CANNOT BE SELECTED (When pressing the "ON/OFF" switch)	Indicates that Multi-terrain Select cannot be operated because vehicle speed exceeds approximately 7 mph (12 km/h).	Reduce vehicle speed.
OP. NOT POSSIBLE WHEN CRAWL CONTROL ACTIVATED (When pressing the "ON/OFF" switch)	Indicates that Multi-terrain Select cannot be operated because Crawl Control is operating.	Turn Crawl Control off.
Multi-terrain Select HAS BEEN CANCELED (When pressing the "ON/OFF" switch)	Indicates that Multi-terrain Select is turned off.	-
Multi-terrain Select NOT AVAILABLE (When pressing the "ON/OFF" switch)	Indicates that Multi-terrain Select cannot be operated because the VSC and/or 4WD system may be malfunctioning.	Contact your Toyota dealer.

■ **Multi-terrain Select is temporarily canceled when**

The front-wheel drive control lever or switch is shifted to H4 when Multi-terrain Select is in ROCK, MOGUL or LOOSE ROCK mode. The mode indicator will flash until the lever is shifted back to L4.

■ **If the Multi-terrain Select indicator continues to flash**

This may indicate a malfunction in the Multi-terrain Select system. In this case, Multi-terrain Select is automatically canceled. Have your vehicle inspected by your Toyota dealer.



■ **If the Multi-terrain Select indicator goes off while Multi-terrain Select is operating**

- One of the vehicle systems related to Multi-terrain Select may be malfunctioning.  
Have your vehicle inspected by your Toyota dealer.
- The brake actuator may be at risk of overheating.  
A buzzer will sound, the “A-TRAC” indicator will go off and the “TRAC OFF” indicator will come on. Stop the vehicle in a safe place. Refrain from using Multi-terrain Select until the “A-TRAC” indicator comes back on and the “TRAC OFF” indicator goes off. (The vehicle can still be driven, even if Multi-terrain Select is inoperative.)

In the above cases, Multi-terrain Select is automatically canceled.

 **CAUTION**

■ **Before driving**

To avoid an accident, observe the precautions relating to off-road driving. (→P. 273)

■ **When using Multi-terrain Select**

- Do not use the Multi-terrain Select system for normal (on-road) driving. The Multi-terrain Select system is designed for off-road use only.
- Do not overly rely on Multi-terrain Select. This function does not extend the vehicle's performance limitations. Always check the terrain thoroughly and drive safely.
- The recommended modes for the listed terrains (→P. 254) are only a reference. The selected mode may not be suitable to actual off-road conditions due to factors such as the type or unevenness of the terrain or the degree of incline. Check the actual terrain thoroughly and drive safely.
- After selecting a mode, make sure that the Multi-terrain Select indicator and the selected mode indicator come on. If any related indicator flashes, the vehicle is not under Multi-terrain Select control.

## Driving assist systems

To help enhance driving safety and performance, the following systems operate automatically in response to various driving situations. Be aware, however, that these systems are supplementary and should not be relied upon too heavily when operating the vehicle.

### ◆ ABS (Anti-lock Brake System)

Helps to prevent wheel lock when the brakes are applied suddenly, or if the brakes are applied while driving on a slippery road surface

### ◆ Multi Terrain ABS (Anti-lock Brake System) (if equipped)

Helps to prevent wheel lock when the brakes are applied suddenly, or if the brakes are applied while driving on a slippery road surface, or in off-road conditions (such as rough roads, sand and mud)

The Multi Terrain ABS operates in synchronization with the Multi-terrain Select.

### ◆ Brake assist

Generates an increased level of braking force after the brake pedal is depressed when the system detects a panic stop situation

### ◆ VSC (Vehicle Stability Control)

Helps the driver to control skidding when swerving suddenly or turning on slippery road surfaces

### ◆ Trailer Sway Control

Helps the driver to control trailer sway by selectively applying brake pressure for individual wheels and reducing engine torque when trailer sway is detected.

Trailer Sway Control is part of the VSC system and will not operate if VSC is turned off or experiences a malfunction.

### ◆ TRAC (Traction Control)

Helps to maintain drive power and prevent the drive wheels from spinning when starting the vehicle or accelerating on slippery roads

◆ **Hill-start assist control (if equipped)**

Helps to prevent the vehicle from rolling backward when starting on an incline or slippery slope

◆ **LSD (Limited Slip Differential) (if equipped)**

Transfers drive power to the rear tires when front tires spin, and vice versa, in order to improve traction

◆ **KDSS (Kinetic Dynamic Suspension System) (if equipped)**

Enhances ride comfort and handling response by using a hydraulic control system to control the suspension stabilizer bars in response to road surface and driving conditions during cornering or off-road driving

**When the TRAC/VSC/Trailer Sway Control systems are operating (2WD models)**

If the vehicle is in danger of slipping or if any of the drive wheels spins, the slip indicator flashes to indicate that the TRAC/VSC/Trailer Sway Control systems are operating.

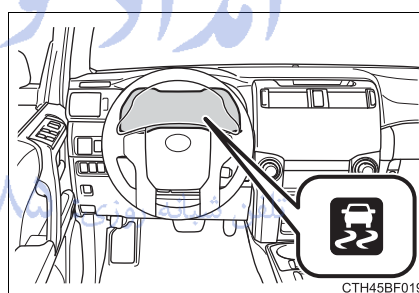

**When the TRAC/VSC/Trailer Sway Control/hill-start assist control systems are operating (4WD models)**

If the vehicle is in danger of slipping or rolling backward when starting on an incline, or if any of the drive wheels spins, the slip indicator flashes to indicate that the TRAC/VSC/Trailer Sway Control/hill-start assist control systems are operating.

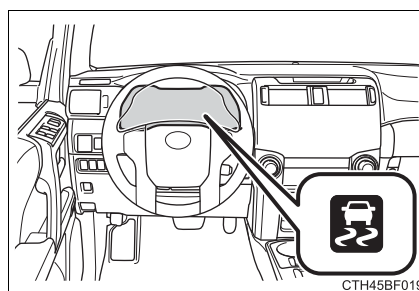

The stop lights and high mounted stoplight turn on and a buzzer (intermittent) sounds when the hill-start assist control system is operating.

**Disabling the TRAC/VSC/Trailer Sway Control systems (2WD models)**

If the vehicle gets stuck in fresh snow or mud, the TRAC/VSC/Trailer Sway Control systems may reduce power from the engine to the wheels. You may need to turn the system off to enable you to rock the vehicle in order to free it.

**■ Turning off the TRAC system only (turning on the AUTO LSD system [→P. 242])**

To turn the TRAC system off, quickly press and release the switch.

The VSC OFF and “AUTO LSD” indicators will come on.

Press the switch again to turn the system back on.

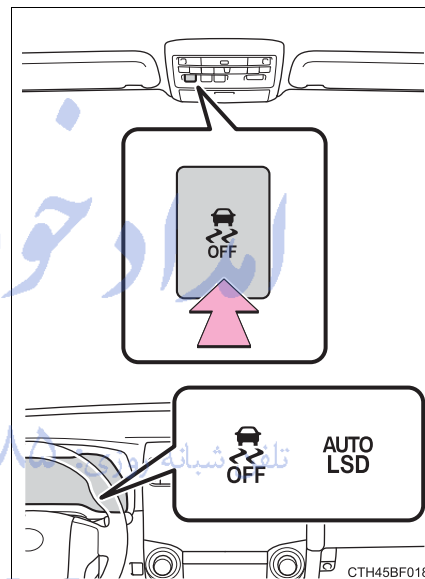

FarmaSOS.com

### ■ Turning off TRAC, VSC and Trailer Sway Control systems

To turn the TRAC, VSC and Trailer Sway Control systems off, press and hold the switch for more than 3 seconds while the vehicle is stopped.

The "TRAC OFF" and VSC OFF indicators will come on.

Press the switch again to turn the systems back on.

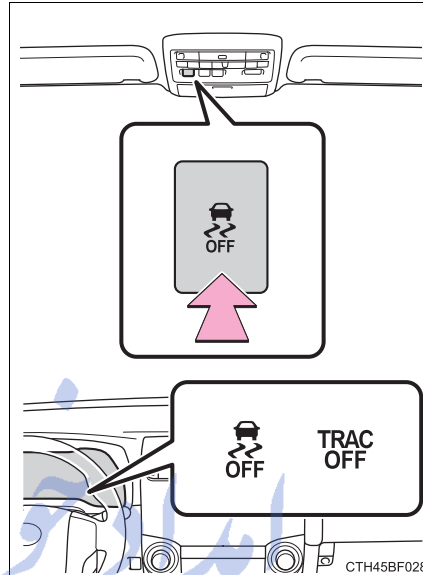

تلفن شبانه روزی: ۰۲۱-۸۸۸۶۲۰۸۵

FarmaSOS.com

**Disabling the TRAC/VSC/Trailer Sway Control systems (4WD models)**

If the vehicle gets stuck in fresh snow or mud, the TRAC/VSC/Trailer Sway Control systems may reduce power from the engine to the wheels. You may need to turn the system off to enable you to rock the vehicle in order to free it.

**■ Turning off the TRAC system only**

To turn the TRAC system off, quickly press and release the switch.

The "TRAC OFF" indicator will come on.

Press the switch again to turn the system back on.

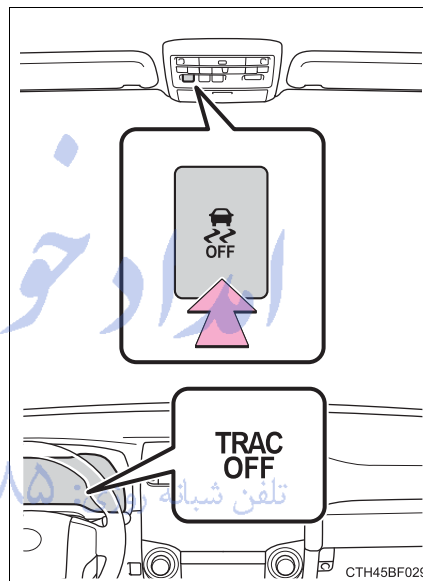

FarmaSOS.com

**■ Turning off TRAC, VSC and Trailer Sway Control systems**

To turn the TRAC, VSC and Trailer Sway Control systems off, press and hold the switch for more than 3 seconds while the vehicle is stopped.

The “TRAC OFF” and VSC OFF indicators will come on.

Press the switch again to turn the systems back on.

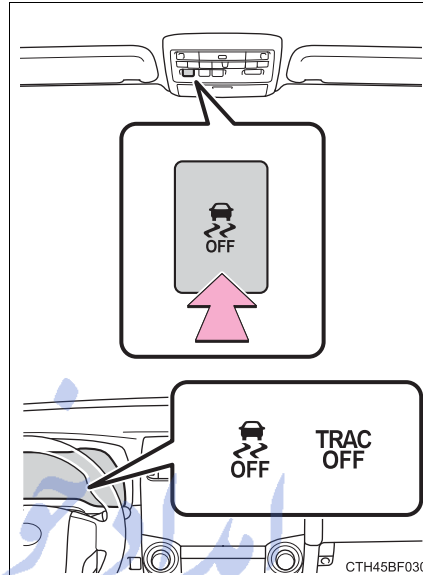

تلفن شبانه روزی: ۰۲۱-۸۸۸۶۲۰۸۵

FarmaSOS.com

■ **When the “TRAC OFF” indicator light comes on even if the VSC off switch has not been pressed**

TRAC, hill-start assist control, downhill assist control and Crawl Control cannot be operated. Contact your Toyota dealer.

■ **Hill-start assist control operation conditions**

- The shift lever is in D or S.
- The brake pedal is not depressed.
- The rear differential is unlocked (if equipped).

■ **If the brake system overheats**

The hill-start assist control will cease operation and a buzzer will sound to alert the driver. At this time, the “TRAC OFF” indicator will come on. Stop the vehicle in a safe place. (There is no problem with continuing with normal driving.)

The system will be automatically restored after a short time.

■ **Sounds and vibrations caused by the ABS, Multi Terrain ABS (if equipped), brake assist, VSC, Trailer Sway Control, TRAC and hill-start assist control (if equipped) systems**

- A sound may be heard from the engine compartment when the engine is started or just after the vehicle begins to move. This sound does not indicate that a malfunction has occurred in any of these systems.
- Any of the following conditions may occur when the above systems are operating. None of these indicates that a malfunction has occurred.
  - Vibrations may be felt through the vehicle body and steering.
  - A motor sound may be heard after the vehicle comes to a stop.
  - The brake pedal may pulsate slightly after the ABS or Multi Terrain ABS is activated.
  - The brake pedal may move down slightly after the ABS or Multi Terrain ABS is activated.

■ **Reactivation of the TRAC/VSC/Trailer Sway Control systems after turning off the engine**

Turning off the engine after turning off the TRAC/VSC/Trailer Sway Control systems will automatically reactivate them.



■ **Reactivation of the VSC and Trailer Sway Control system linked to vehicle speed (2WD models)**

When the TRAC system is turned off and the AUTO LSD system is turned on, the VSC and Trailer Sway Control system will turn on when vehicle speed increases. However, when the TRAC, VSC and Trailer Sway Control systems are turned off, the systems will not turn on even when vehicle speed increases.

■ **Reactivation of the TRAC/VSC/Trailer Sway Control systems (4WD models)**

If the TRAC/VSC/Trailer Sway Control systems are turned off, the systems will not turn on even when vehicle speed increases.

 CAUTION

■ **The ABS and Multi Terrain ABS do not operate effectively when**

- The limits of tire gripping performance have been exceeded (such as excessively worn tires on a snow covered road).
- The vehicle hydroplanes while driving at high speed on wet or slick roads.

■ **Stopping distance when the ABS or Multi Terrain ABS is operating may exceed that of normal conditions**

The ABS and Multi Terrain ABS are not designed to shorten the vehicle's stopping distance. Always maintain a safe distance from the vehicle in front of you, especially in the following situations:

- When driving on dirt, gravel or snow-covered roads
- When driving with tire chains
- When driving over bumps in the road
- When driving over roads with potholes or roads with uneven surfaces

■ **TRAC may not operate effectively when**

Directional control and power may not be achievable while driving on slippery road surfaces, even if the TRAC system is operating.

Do not drive the vehicle in conditions where stability and power may be lost.

■ **Hill-start assist control does not operate effectively when**

Do not overly rely on the hill-start assist control. The hill-start assist control may not operate effectively on steep inclines and roads covered with ice.

 CAUTION

■ **When the VSC and Trailer Sway Control are activated**

The slip indicator light flashes. Always drive carefully. Reckless driving may cause an accident. Exercise particular care when the indicator light flashes.

■ **When TRAC/VSC/Trailer Sway Control systems are turned off**

Be especially careful and drive at a speed appropriate to the road conditions. As these are systems to ensure vehicle stability and driving force, do not turn the TRAC/VSC/Trailer Sway Control systems off unless necessary.

■ **Replacing tires**

Make sure that all tires are of the specified size, brand, tread pattern and total load capacity. In addition, make sure that the tires are inflated to the recommended tire inflation pressure level.

The ABS, Multi Terrain ABS, VSC and Trailer Sway Control will not function correctly if different tires are fitted on the vehicle.

Contact your Toyota dealer for further information when replacing tires or wheels.

■ **Handling of tires and the suspension**

Using tires with any kind of problem or modifying the suspension will affect the driving assist systems, and may cause a system to malfunction.

■ **Trailer Sway Control precaution**

The Trailer Sway Control system is not able to reduce trailer sway in all situations.

Depending on many factors such as the conditions of the vehicle, trailer, road surface, and driving environment, the Trailer Sway Control system may not be effective. Refer to your trailer owner's manual for information on how to tow your trailer properly.

■ **If trailer sway occurs**

Observe the following precautions.

Failing to do so may cause death or serious injury.

● Firmly grip the steering wheel. Steer straight ahead.

Do not try to control trailer swaying by turning the steering wheel.

● Begin releasing the accelerator pedal immediately but very gradually to reduce speed.

Do not increase speed. Do not apply vehicle brakes.

If you make no extreme correction with the steering or brakes, your vehicle and trailer should stabilize. (→P. 188)

## Winter driving tips

**Carry out the necessary preparations and inspections before driving the vehicle in winter. Always drive the vehicle in a manner appropriate to the prevailing weather conditions.**

### Preparation for winter

- Use fluids that are appropriate to the prevailing outside temperatures.
  - Engine oil
  - Engine coolant
  - Washer fluid
- Have a service technician inspect the condition of the battery.
- Have the vehicle fitted with four snow tires or purchase a set of tire chains for the rear tires.

Ensure that all tires are the same size and brand, and that chains match the size of the tires.

تلفن شبانه روزی: ۰۲۱-۸۸۶۲۰۸۵

FarmaSOS.com

### **Before driving the vehicle**

Perform the following according to the driving conditions:

- Do not try to forcibly open a window or move a wiper that is frozen. Pour warm water over the frozen area to melt the ice. Wipe away the water immediately to prevent it from freezing.
- To ensure proper operation of the climate control system fan, remove any snow that has accumulated on the air inlet vents in front of the windshield.
- Check for and remove any excess ice or snow that may have accumulated on the exterior lights, vehicle's roof, chassis, around the tires or on the brakes.
- Remove any snow or mud from the bottom of your shoes before getting in the vehicle.

### **When driving the vehicle**

Accelerate the vehicle slowly, keep a safe distance between you and the vehicle ahead, and drive at a reduced speed suitable to road conditions.

### **When parking the vehicle**

Park the vehicle and move the shift lever to P without setting the parking brake. The parking brake may freeze up, preventing it from being released. If necessary, block the wheels to prevent inadvertent sliding or creeping.

FarmaSOS.com

### Selecting tire chains

Use the correct tire chain size when mounting the tire chains.  
Chain size is regulated for each tire size.

- ① Side chain  
(0.20 in. [5 mm] in diameter)
- ② Cross chain  
(0.20 in. [5 mm] in diameter)

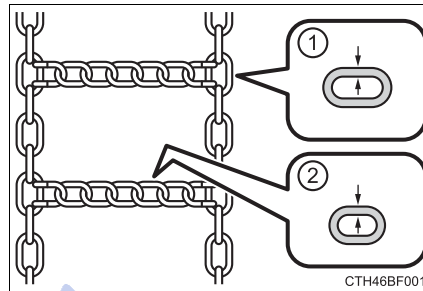

### Regulations on the use of tire chains

Regulations regarding the use of tire chains vary depending on location and type of road. Always check local regulations before installing chains.

#### ■ Tire chain installation

Observe the following precautions when installing and removing chains:

- Install and remove tire chains in a safe location.
- Install tire chains on the rear tires only. Do not install tire chains on the front tires.
- Install tire chains on rear tires as tightly as possible. Retighten chains after driving 1/4 — 1/2 mile (0.5 — 1.0 km).
- Install tire chains following the instructions provided with the tire chains.

 CAUTION

**■ Driving with snow tires**

Observe the following precautions to reduce the risk of accidents. Failure to do so may result in a loss of vehicle control and cause death or serious injury.

- Use tires of the specified size.
- Maintain the recommended level of air pressure.
- Do not drive in excess of 75 mph (120 km/h), regardless of the type of snow tires being used.
- Use snow tires on all, not just some wheels.

**■ Driving with tire chains**

Observe the following precautions to reduce the risk of accidents. Failure to do so may result in the vehicle being unable to be driven safely, and may cause death or serious injury.

- Do not drive in excess of the speed limit specified for the tire chains being used, or 30 mph (50 km/h), whichever is lower.
- Avoid driving on bumpy road surfaces or over potholes.
- Avoid sudden acceleration, abrupt steering, sudden braking and shifting operations that cause sudden engine braking.
- Slow down sufficiently before entering a curve to ensure that vehicle control is maintained.

 NOTICE

**■ Repairing or replacing snow tires**

Request repairs or replacement of snow tires from Toyota dealers or legitimate tire retailers.

This is because the removal and attachment of snow tires affects the operation of the tire pressure warning valves and transmitters.

**■ Fitting tire chains**

The tire pressure warning valves and transmitters may not function correctly when tire chains are fitted.

## Off-road precautions

**This vehicle belongs to the utility vehicle class, which has higher ground clearance and narrower tread in relation to the height of its center of gravity to make it capable of performing in a wide variety of off-road applications.**

### Off-road vehicle feature

- Specific design characteristics give it a higher center of gravity than ordinary passenger cars. This vehicle design feature causes this type of vehicle to be more likely to rollover. And, utility vehicles have a significantly higher rollover rate than other types of vehicles.
- An advantage of the higher ground clearance is a better view of the road allowing you to anticipate problems.
- It is not designed for cornering at the same speeds as ordinary passenger cars any more than low-slung sports cars designed to perform satisfactorily under off-road conditions. Therefore, sharp turns at excessive speeds may cause rollover.

تلفن شبانه روزی: ۰۲۱-۸۸۶۲۰۸۵

FarmaSOS.com

 CAUTION**Off-road vehicle precautions**

Always observe the following precautions to minimize the risk of death, serious injury or damage to your vehicle:

- In a rollover crash, an unbelted person is significantly more likely to die than a person wearing a seat belt. Therefore, the driver and all passengers should fasten their seat belts whenever the vehicle is moving.
- Avoid sharp turns or abrupt maneuvers, if at all possible.  
Failure to operate this vehicle correctly may result in loss of control or vehicle rollover causing death or serious injury.
- Loading cargo on the roof luggage carrier will make the center of the vehicle gravity higher. Avoid high speeds, sudden starts, sharp turns, sudden braking or abrupt maneuvers, otherwise it may result in loss of control or vehicle rollover due to failure to operate this vehicle correctly.
- Always slow down in gusty crosswinds. Because of its profile and higher center of gravity, your vehicle is more sensitive to side winds than an ordinary passenger car. Slowing down will allow you to have better control.
- When driving off-road or in rugged terrain, do not drive at excessive speeds, jump, make sharp turns, strike objects, etc. This may cause loss of control or vehicle rollover causing death or serious injury. You are also risking expensive damage to your vehicle's suspension and chassis.
- Do not drive horizontally across steep slopes. Driving straight up or straight down is preferred. Your vehicle (or any similar off-road vehicle) can tip over sideways much more easily than forward or backward.

FarmaSOS.com



### Off-road driving

When driving your vehicle off-road, please observe the following precautions to ensure your driving enjoyment and to help prevent the closure of areas to off-road vehicles:

- Drive your vehicle only in areas where off-road vehicles are permitted to travel.
- Respect private property. Get owner's permission before entering private property.
- Do not enter areas that are closed. Honor gates, barriers and signs that restrict travel.
- Stay on established roads. When conditions are wet, driving techniques should be changed or travel delayed to prevent damage to roads.

### ■ Additional information for off-road driving

For owners in U.S. mainland, Hawaii and Puerto Rico:

To obtain additional information pertaining to driving your vehicle off-road, consult the following organizations.

- State and Local Parks and Recreation Departments
- State Motor Vehicle Bureau
- Recreational Vehicle Clubs
- U.S. Forest Service and Bureau of Land Management

FarmaSOS.com

 CAUTION**Off-road driving precautions**

Always observe the following precautions to minimize the risk of death, serious injury or damage to your vehicle:

- Drive carefully when off the road. Do not take unnecessary risks by driving in dangerous places.
- Do not grip the steering wheel spokes when driving off-road. A bad bump could jerk the wheel and injure your hands. Keep both hands and especially your thumbs on the outside of the rim.
- Always check your brakes for effectiveness immediately after driving in sand, mud, water or snow.
- After driving through tall grass, mud, rock, sand, rivers, etc., check that there is no grass, bush, paper, rags, stone, sand, etc. adhering or trapped on the underbody. Clear off any such matter from the underbody. If the vehicle is used with these materials trapped or adhering to the underbody, a breakdown or fire could occur.
- In a rollover crash, an unbelted person is significantly more likely to die than a person wearing a seat belt. Therefore, the driver and all passengers should fasten their seat belts whenever the vehicle is moving.
- When driving off-road or in rugged terrain, do not drive at excessive speeds, jump, make sharp turns, strike objects, etc. This may cause loss of control or vehicle rollover causing death or serious injury. You are also risking expensive damage to your vehicle's suspension and chassis.

FarmaSOS.com

 NOTICE

■ **To prevent water damage**

Take all necessary safety measures to ensure that water damage to the engine or other components does not occur.

- Water entering the engine air intake will cause severe engine damage.
- Water entering the automatic transmission will cause deterioration in shift quality, locking up of your transmission accompanied by vibration, and ultimately damage.
- Water can wash the grease from wheel bearings, causing rusting and premature failure, and may also enter the differentials, transmission and transfer case, reducing the gear oil's lubricating qualities.

■ **When you drive through water**

If driving through water, such as when crossing shallow streams, first check the depth of the water and the bottom of the riverbed for firmness. Drive slowly and avoid deep water.

■ **Inspection after off-road driving**

- Sand and mud that has accumulated in brake drums and around brake discs may affect braking efficiency and may damage brake system components.
- Always perform a maintenance inspection after each day of off-road driving that has taken you through rough terrain, sand, mud, or water. For scheduled maintenance information, refer to the "Scheduled Maintenance Guide" or "Owner's Manual Supplement".

FarmaSOS.com

# امداد خودرو فارما

تلفن شبانه روزی: ۰۲۱-۸۸۸۶۲۰۸۵

**FarmaSOS.com**

## Interior features

# 5

### 5-1. Using the air conditioning system and defogger

Manual air conditioning system.....	280
Automatic air conditioning system.....	286
Seat heaters/ seat ventilators.....	293

### 5-2. Using the interior lights

Interior lights list .....	295
• Interior lights .....	296
• Personal lights .....	296

### 5-3. Using the storage features

List of storage features .....	298
• Glove box.....	299
• Console box.....	299
• Cup holders .....	300
• Auxiliary box .....	302
• Coin holder/tissue pocket/pen holder .....	303
• Bottle holders.....	304
Luggage compartment features .....	305

### 5-4. Other interior features

Other interior features .....	310
• Sun visors .....	310
• Vanity mirrors.....	310
• Clock.....	311
• Outside temperature display.....	312
• Power outlets (120 V AC).....	314
• Power outlets .....	319
• Armrest .....	321
• Assist grips .....	322
Garage door opener.....	323
Safety Connect .....	330
Compass.....	335

## Manual air conditioning system\*

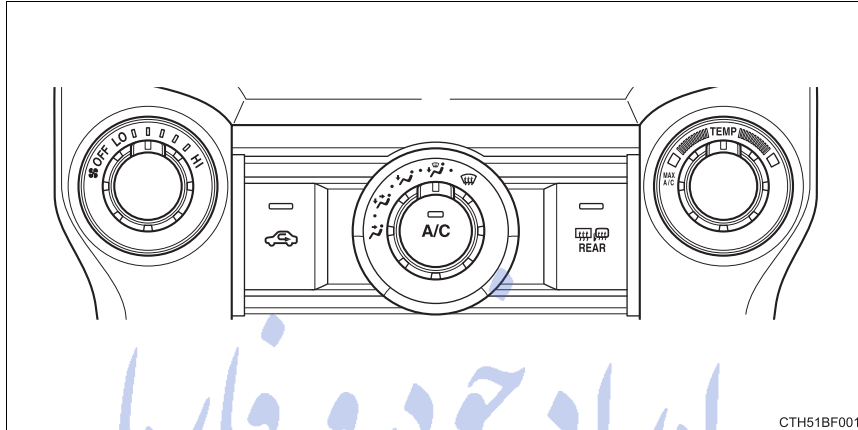

### Air conditioning controls



#### ■ Adjusting the temperature setting

To adjust the temperature setting, turn  clockwise (warm) or counterclockwise (cool).

If  is not pressed, the system will blow ambient temperature air or heated air.

For quick cooling, turn the temperature control knob to "MAX A/C". The air conditioning will automatically turn on and, if an air outlet position other than  or  is selected, the system will be set to recirculated air mode. While "MAX A/C" is selected, it is not possible to turn off the air conditioning.

\*: If equipped

### ■ Fan speed setting

To adjust the fan speed, turn  clockwise (increase) or counterclockwise (decrease).

Turning the knob to "OFF" turns off the fan.

### ■ Change the airflow mode

To select the air outlets, set  to the desired position.

The positions between the air outlet selections shown below can also be selected for more delicate adjustment.

### ■ Other functions

- Switching between outside air and recirculated air modes (→P. 281)
- Defogging the windshield (→P. 282)
- Defogging the rear window and outside rear view mirrors (→P. 282)
- Windshield wiper de-icer (if equipped) (→P. 282)

### Other functions

#### ■ Switching between outside air and recirculated air modes

Press  .

The mode switches between outside air mode (introduces air from outside the vehicle) (indicator off) and recirculated air mode (recycles air inside the vehicle) (indicator on) each time the button is pressed.

### ■ Defogging the windshield

Defoggers are used to defog the windshield and front side windows.

Set the air outlet selector dial to  position.

If the recirculated air mode is used, it will automatically switch to outside air mode.

To defog the windshield and the side windows early, increase the air flow and temperature.

If the dehumidification function is not operating, press  to operate the dehumidification function.

### ■ Defogging the rear window and outside rear view mirrors

Defoggers are used to defog the rear window, and to remove rain-drops, dew and frost from the outside rear view mirrors.

Before operating the defoggers, make sure the back window is completely closed. (→P. 151)

Press 

The defoggers will automatically turn off after their operation time. The operation time varies depending on the ambient temperature and vehicle speed.

### ■ Windshield wiper de-icer (if equipped)

This feature is used to prevent ice from building up on the windshield and wiper blades.

Turns the windshield wiper de-icer on/off

The windshield wiper de-icer will automatically turn off after approximately 15 minutes.

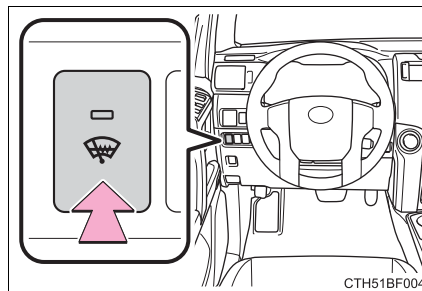



## Air outlets

### ■ Location of air outlets

The air outlets and air volume changes according to the selected airflow mode.

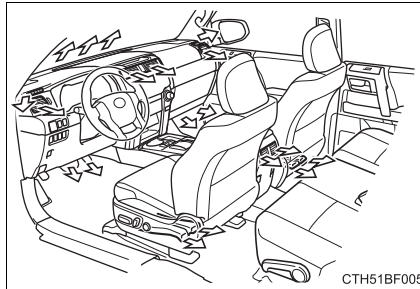

### ■ Adjusting the position of and opening and closing the air outlets

#### ► Front center outlets

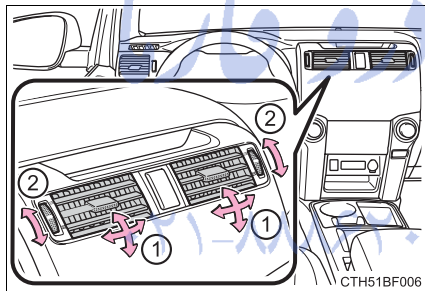

#### ► Front side outlets

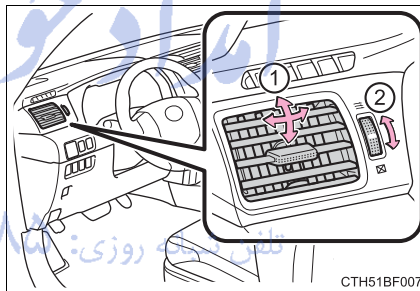

#### ► Rear outlets

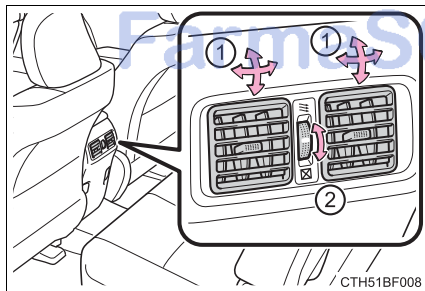

- ① Direct air flow to the left or right, up or down.
- ② Turn the knob to open or close the vent.

### ■ Fogging up of the windows

- The windows will easily fog up when the humidity in the vehicle is high.

Turning  on will dehumidify the air from the outlets and defog the windshield effectively.

- If you turn  off, the windows may fog up more easily.
- The windows may fog up if the recirculated air mode is used.

### ■ Outside/recirculated air mode

When driving on dusty roads such as tunnels or in heavy traffic, set the outside/recirculated air mode to the recirculated air mode. This is effective in preventing outside air from entering the vehicle interior. During cooling operation, setting the recirculated air mode will also cool the vehicle interior effectively.

### ■ When the outside temperature exceeds 75°F (24°C) and the air conditioning system is on

- In order to reduce the air conditioning power consumption, the air conditioning system may switch to recirculated air mode automatically. This may also reduce fuel consumption.
- Recirculated air mode is selected as a default mode when the engine switch is turned to the "ON" position (vehicles without a smart key system) or the engine switch is turned to IGNITION ON mode (vehicles with a smart key system).
- It is possible to switch to outside air mode at any time by pressing  .

### ■ When the indicator light on flashes

Press  to turn off the cooling and dehumidification function and turn it on again. There may be a problem in the air conditioning system if the indicator light continues to flash. Turn the air conditioning system off and have it inspected by your Toyota dealer.

### ■ When the outside temperature falls to nearly 32°F (0°C)

The dehumidification function may not operate even when  is pressed.

### ■ Air conditioning odors

- During use, various odors from inside and outside the vehicle may enter into and accumulate in the air conditioning system. This may then cause odor to be emitted from the vents.
- To reduce potential odors from occurring:  
It is recommended that the air conditioning system be set to outside air mode prior to turning the vehicle off.

### ⚠ CAUTION

#### ■ To prevent the windshield from fogging up

- Do not use  during cool air operation in extremely humid weather. The difference between the temperature of the outside air and that of the windshield can cause the outer surface of the windshield to fog up, blocking your vision.
- Do not place anything on the instrument panel which may cover the air outlets. Otherwise, air flow may be obstructed, preventing the windshield defoggers from defogging.

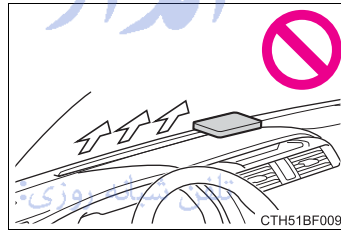

#### ■ To prevent burns

- Do not touch the rear view mirror surfaces when the outside rear view mirror defoggers are on.
- Do not touch the glass at lower part of the windshield or to the side of the front pillars when the windshield wiper de-icer is on.

### ⚠ NOTICE

#### ■ To prevent battery discharge

Do not leave the air conditioning system on longer than necessary when the engine is stopped.

## Automatic air conditioning system\*

**Air outlets and fan speed are automatically adjusted according to the temperature setting.**

### Air conditioning controls

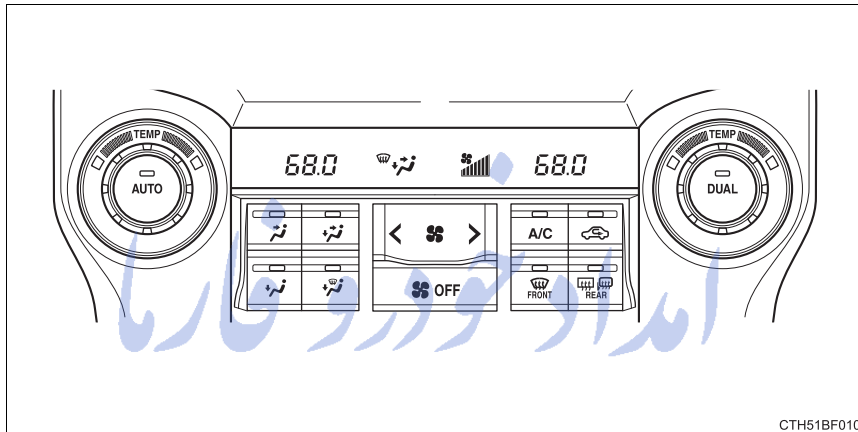



#### ■ Adjusting the temperature setting

To adjust the temperature setting, turn  clockwise to

increase the temperature and turn  counterclockwise to decrease the temperature.

#### ■ Fan speed setting

To adjust the fan speed, press ">" on  to increase the fan speed and "<" to decrease the fan speed.

Press  to turn the fan off.

\*: If equipped

### ■ Change the airflow mode

To change the air outlets, press , ,  or .

### ■ Other functions

- Switching between outside air and recirculated air modes (→P. 288)
- Defogging the windshield (→P. 288)
- Defogging the rear window and outside rear view mirrors (→P. 288)
- Windshield wiper de-icer (if equipped) (→P. 289)

### Using automatic mode

- 1 Press .

The air conditioning system begins to operate. Air outlets and fan speed are automatically adjusted according to the temperature setting.

- 2 Adjust the temperature setting.
- 3 To stop the operation, press .

#### ■ If the system is operated manually in automatic mode

If the fan speed setting or air flow modes are operated, the automatic mode indicator goes off. However, automatic mode for functions other than that operated are maintained.

#### ■ Adjusting the temperature for driver and passenger seats separately (“DUAL” mode)

Perform the following procedures to turn on the “DUAL” mode:

- Press .
- Adjust the passenger’s side temperature setting.  
The indicator comes on when the “DUAL” mode is on.  
While in “DUAL” mode, the temperature of the rear air outlets is set at the right-hand side temperature setting.

### Other functions

#### ■ Switching between outside air and recirculated air modes

Press  .

The mode switches between outside air mode (the indicator is off) and recirculated air mode (the indicator is on) each time the button is pressed.

#### ■ Defogging the windshield

Defoggers are used to defog the windshield and front side windows.

Press  .

The dehumidification function operates and fan speed increases. Set the outside/recirculated air mode button to the outside air mode if the recirculated air mode is used. (It may switch automatically.) To defog the windshield and the side windows early, turn the air flow and temperature up.

To return to the previous mode, press  again when the windshield is defogged.

#### ■ Defogging the rear window and outside rear view mirrors

Defoggers are used to defog the rear window, and to remove rain-drops, dew and frost from the outside rear view mirrors.

Before operating the defoggers, make sure the back window is completely closed. (→P. 151)

Press  .

The defoggers will automatically turn off after their operation time. The operation time varies depending on the ambient temperature and vehicle speed.

■ **Windshield wiper de-icer (if equipped)**

This feature is used to prevent ice from building up on the windshield and wiper blades.

Turns the windshield wiper de-icer on/off

The windshield wiper de-icer will automatically turn off after approximately 15 minutes.

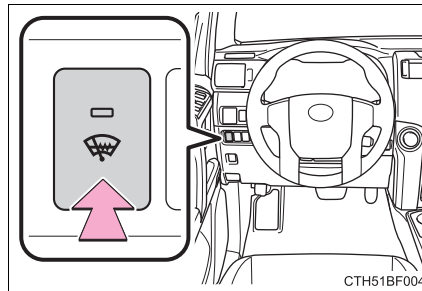

**Air outlets**

■ **Location of air outlets**

The air outlets and air volume changes according to the selected airflow mode.

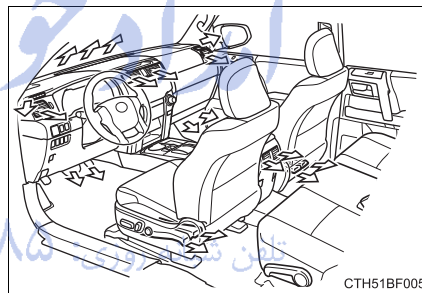

■ **Adjusting the position of and opening and closing the air outlets**

- ▶ Front center outlets
- ▶ Front side outlets

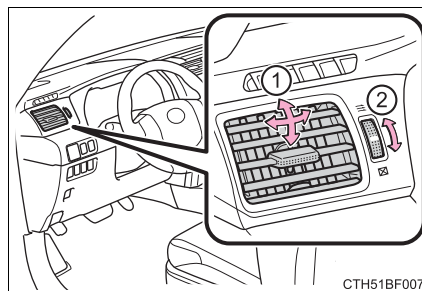
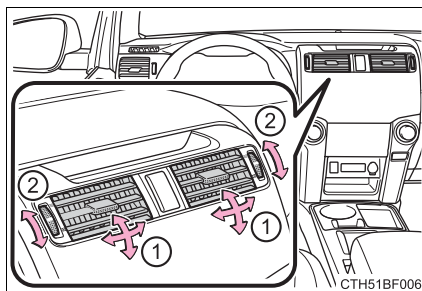

► Rear outlets

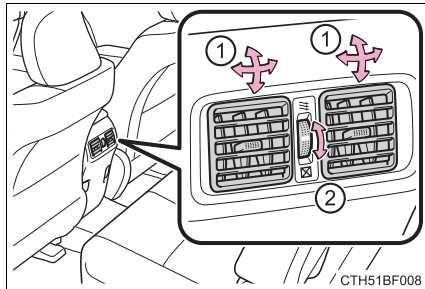

- ① Direct air flow to the left or right, up or down.
- ② Turn the knob to open or close the vent.

■ Using automatic mode

Fan speed is adjusted automatically according to the temperature setting and the ambient conditions.

Therefore, the fan may stop for a while until warm or cool air is ready to flow immediately after  is pressed.

■ Fogging up of the windows

- The windows will easily fog up when the humidity in the vehicle is high. Turning  on will dehumidify the air from the outlets and defog the windshield effectively.

- If you turn  off, the windows may fog up more easily.

- The windows may fog up if the recirculated air mode is used.

■ Outside/recirculated air mode

- When driving on dusty roads such as tunnels or in heavy traffic, set the outside/recirculated air mode to the recirculated air mode. This is effective in preventing outside air from entering the vehicle interior. During cooling operation, setting the recirculated air mode will also cool the vehicle interior effectively.

- Outside/recirculated air mode may automatically switch depending on the temperature setting, outside temperature, pressure, engine coolant temperature or inside temperature.



■ **When the outside temperature exceeds 75°F (24°C) and the air conditioning system is on**

- In order to reduce the air conditioning power consumption, the air conditioning system may switch to recirculated air mode automatically. This may also reduce fuel consumption.
- Recirculated air mode is selected as a default mode when the engine switch is turned to the "ON" position (vehicles without a smart key system) or the engine switch is turned to IGNITION ON mode (vehicles with a smart key system).
- It is possible to switch to outside air mode at any time by pressing  .

■ **When the outside temperature falls to nearly 32°F (0°C)**

The dehumidification function may not operate even when  is pressed.

■ **When driving on dusty roads**

Close all windows. If dust thrown up by the vehicle is still drawn into the vehicle after closing the windows, it is recommended that the air intake mode be set to outside air mode and the fan speed to any setting except off.

■ **When the indicator light on  flashes**

Press  to turn off the cooling and dehumidification function and turn it on again. There may be a problem in the air conditioning system if the indicator light continues to flash. Turn the air conditioning system off and have it inspected by your Toyota dealer.

■ **Air conditioning odors**

- During use, various odors from inside and outside the vehicle may enter into and accumulate in the air conditioning system. This may then cause odor to be emitted from the vents.
- To reduce potential odors from occurring:
  - It is recommended that the air conditioning system be set to outside air mode prior to turning the vehicle off.
  - The start timing of the blower may be delayed for a short period of time immediately after the air conditioning system is started in automatic mode.

■ **Air conditioning filter**

→P. 383

 CAUTION

■ **To prevent the windshield from fogging up**

- Do not use  during cool air operation in extremely humid weather.

The difference between the temperature of the outside air and that of the windshield can cause the outer surface of the windshield to fog up, blocking your vision.

- Do not place anything on the instrument panel which may cover the air outlets. Otherwise, air flow may be obstructed, preventing the windshield defoggers from defogging.

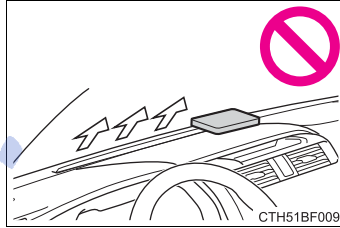

■ **To prevent burns**

- Do not touch the rear view mirror surfaces when the outside rear view mirror defoggers are on.
- Do not touch the glass at lower part of the windshield or to the side of the front pillars when the windshield wiper de-icer is on.

 NOTICE

■ **To prevent battery discharge**

Do not leave the air conditioning system on longer than necessary when the engine is stopped.

## Seat heaters\*/seat ventilators\*

**The seat heaters warm the seats and the seat ventilators maintain good airflow by blowing air through the seats.**

### CAUTION

- Care should be taken to prevent injury if anyone in the following categories comes in contact with the seats when the heater is on:
  - Babies, small children, the elderly, the sick and the physically challenged
  - Persons with sensitive skin
  - Persons who are fatigued
  - Persons who have taken alcohol or drugs that induce sleep (sleeping drugs, cold remedies, etc.)
- Observe the following precautions to prevent the minor burns or overheating
  - Do not cover the seat with a blanket or cushion when using the seat heater.
  - Do not use seat heater more than necessary.

### NOTICE

- Do not put heavy objects that have an uneven surface on the seat and do not stick sharp objects (needles, nails, etc.) into the seat.
- To prevent battery discharge, do not use the functions when the engine is off.

5

Interior features

\*: If equipped

### Seat heaters/ventilators

#### ► Vehicles with ventilator

- ① Press the knob to release it, and turn the knob to the desired temperature setting.
- ② OFF  
Press the knob to lock it when not in use.
- ③ Ventilation
- ④ Heat

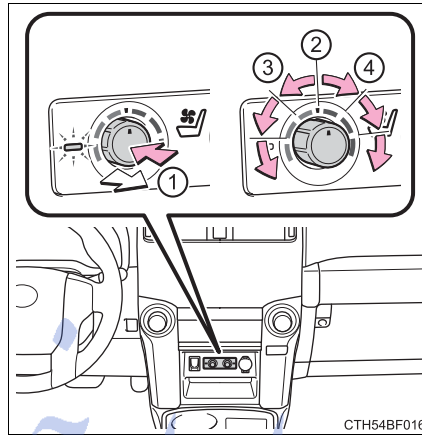

#### ► Vehicles without ventilator

- ① On  
The indicator light comes on.
- ② Adjusts the seat temperature  
The further you move the dial forward, the warmer the seat becomes.
- ③ Off  
Move the dial fully backward.  
The indicator light turns off.

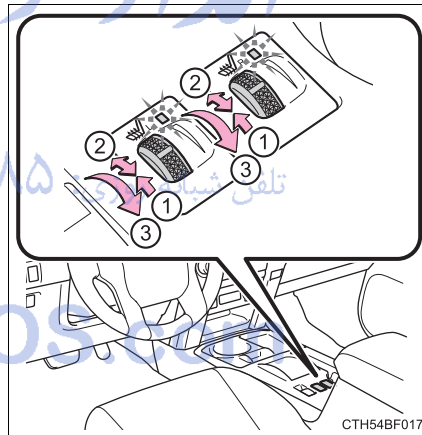

#### ■ The seat heaters/seat ventilators can be used when

- Vehicles without a smart key system  
The engine switch is in the "ON" position.
- Vehicles with a smart key system  
The engine switch is in IGNITION ON mode.

## Interior lights list

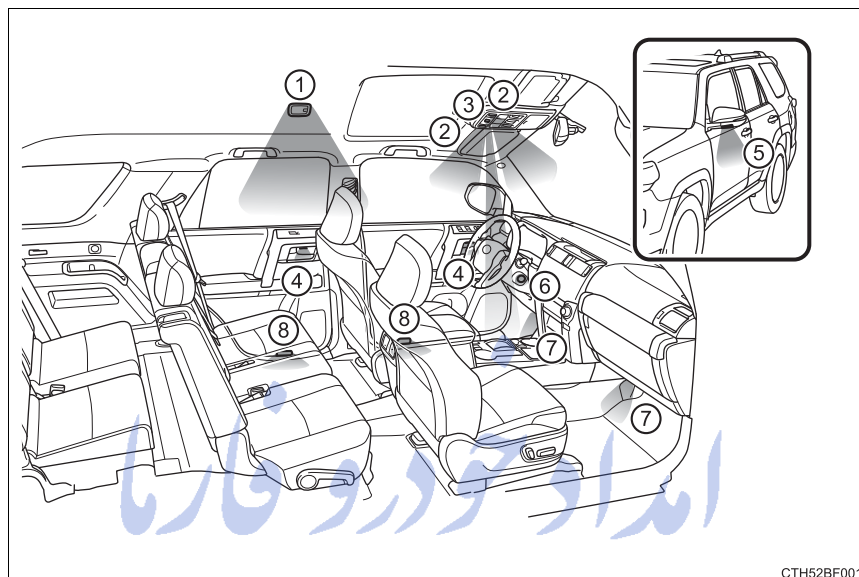

CTH52BF001

- ① Rear interior light (→P. 296)
- ② Front interior light/front personal lights (→P. 296)
- ③ Shift lever light (when the engine switch is in the “ACC” or “ON” position [without a smart key system] or the engine switch is in ACCESSORY or IGNITION ON mode [with a smart key system])
- ④ Inside door handle lights (if equipped)
- ⑤ Outer foot lights (if equipped)
- ⑥ Engine switch light (vehicles without a smart key system)
- ⑦ Footwell lights (if equipped)
- ⑧ Door courtesy lights

Turning the instrument panel light control dial fully downward disables the inside door handle lights, footwell lights and shift lever light.  
(→P. 82)

5

Interior features

### Interior lights

#### ■ Front

- ① Turns the lights off
- ② Turns the door position on

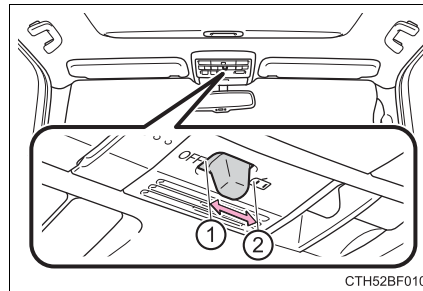

#### ■ Rear

- ① Turns the door position on
- ② Turns the light off
- ③ Turns the light on

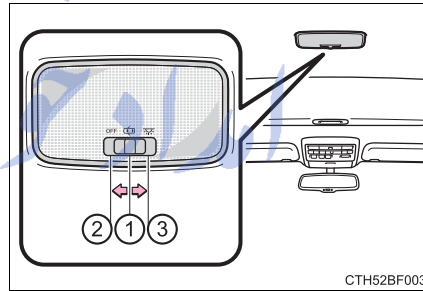

### Personal lights

Turns the lights on/off

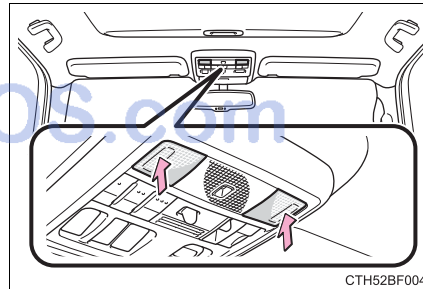

### ■ Illuminated entry system

#### ▶ Vehicles without a smart key system

The lights automatically turn on/off according to the engine switch position, whether the doors are locked/unlocked, and whether the doors are open/closed.

#### ▶ Vehicles with a smart key system

The lights automatically turn on/off according to engine switch mode, the presence of the electronic key, whether the doors are locked/unlocked, and whether the doors are opened/closed.

### ■ To prevent battery discharge

If the following lights remain on, the lights will go off automatically after 20 minutes:

- Engine switch light
- Front interior light
- Rear interior light
- Personal lights
- Footwell lights
- Inside door handle lights
- Door courtesy lights

### ■ Customization

Setting (e.g. the time elapsed before lights turn off) can be changed.  
(Customizable features: →P. 485)



#### NOTICE

#### ■ To prevent battery discharge

Do not leave the lights on longer than necessary when the engine is not running.

## List of storage features

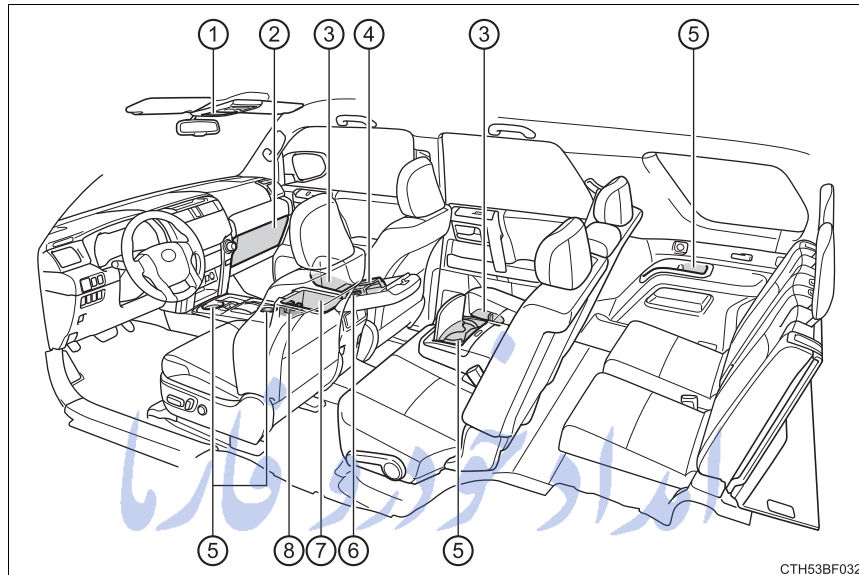

- |                            |                         |
|----------------------------|-------------------------|
| ① Auxiliary box (→P. 302)  | ⑤ Cup holders (→P. 303) |
| ② Glove box (→P. 299)      | ⑥ Pen holder (→P. 303)  |
| ③ Bottle holders (→P. 304) | ⑦ Console box (→P. 299) |
| ④ Tissue pocket (→P. 303)  | ⑧ Coin holder (→P. 303) |

### ⚠ CAUTION

- Do not leave glasses, lighters or spray cans in the storage spaces, as this may cause the following when cabin temperature becomes high:
  - Glasses may be deformed by heat or cracked if they come into contact with other stored items.
  - Lighters or spray cans may explode. If they come into contact with other stored items, the lighter may catch fire or the spray can may release gas, causing a fire hazard.
- When driving or when the storage compartments are not in use, keep the lids closed. In the event of sudden braking or sudden swerving, an accident may occur due to an occupant being struck by an open lid or the items stored inside.



### Glove box

The glove box can be opened by pressing the lock release button and can be locked and unlocked by using the master key (vehicles without a smart key system) or the mechanical key (vehicles with a smart key system).

- ① Open
- ② Unlock
- ③ Lock

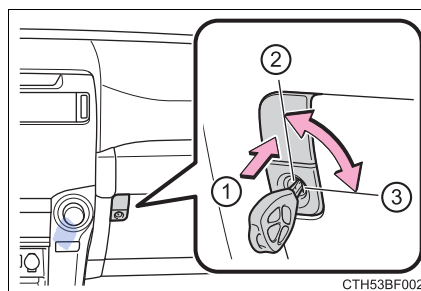

### Console box

Lift the lid while pulling up the knob to release the lock.

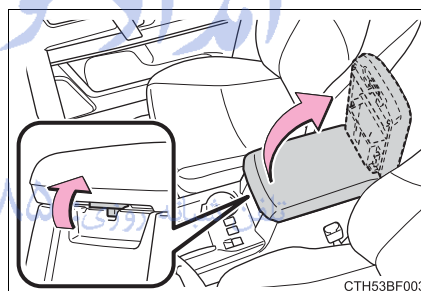

■ The separator can be used in either of the positions shown in the illustration

Change the separator position.

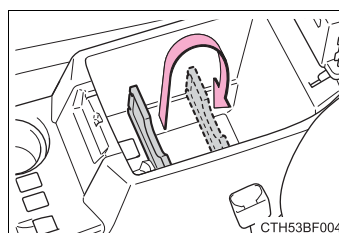

### Cup holders

► Front seats

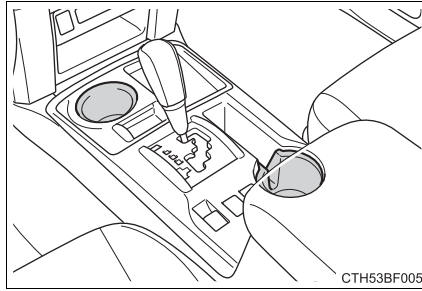

► Rear seats (without third row seats)

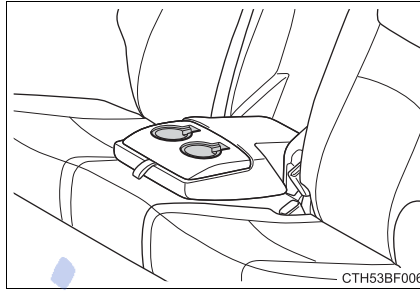

Pull down the rear seat center armrest.

► Second row seats (with third row seats)

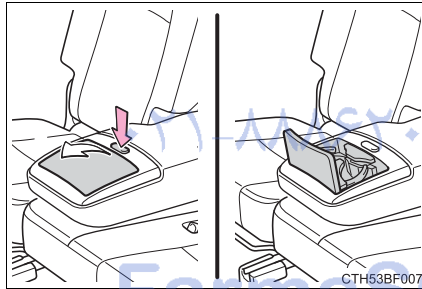

► Third row seats (if equipped)

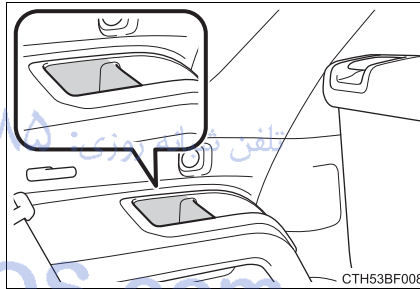

Pull down the second row seat center armrest and press down the button on the armrest.

### ■ Adjusting the size of the cup holders

#### ▶ Front seats

Remove the adapter.

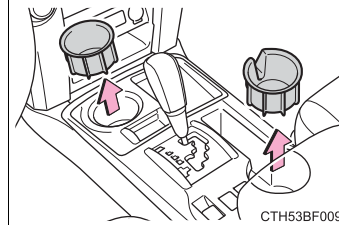

#### ▶ Rear seats (without third row seats)

Remove the adapter.

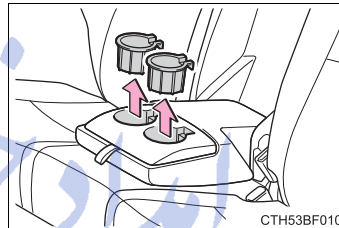

### ⚠ CAUTION

#### ■ Items unsuitable for the cup holders

Do not place anything other than cups or aluminum cans in the cup holders. Other items may be thrown out of the holders in the event of an accident or sudden braking, causing injury. If possible, cover hot drinks to prevent burns.

#### ■ When not in use (second row seat cup holders only)

Keep the cup holders closed. In the event of sudden braking, an accident may occur due to an occupant being struck by the open cup holders or the items stored inside.

### ⚠ NOTICE

#### ■ To prevent damage to the rear cup holders (second row seats only)

Stow the cup holders before stowing the armrest.

### Auxiliary box (If equipped)

Push the lid.

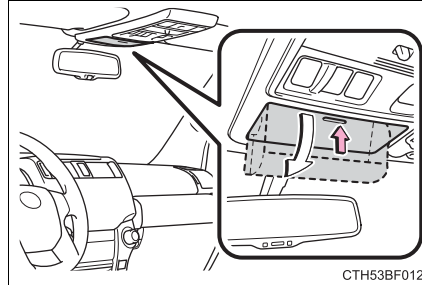

#### CAUTION

##### ■ Items unsuitable for storing

Do not store items heavier than 0.4 lb. (0.2 kg).  
Doing so may cause the auxiliary box to open and the items inside may fall out, resulting in an accident.

تلفن شبانه روزی: ۰۲۱-۸۸۸۶۲۰۸۵

FarmaSOS.com

### Coin holder/tissue pocket/pen holder

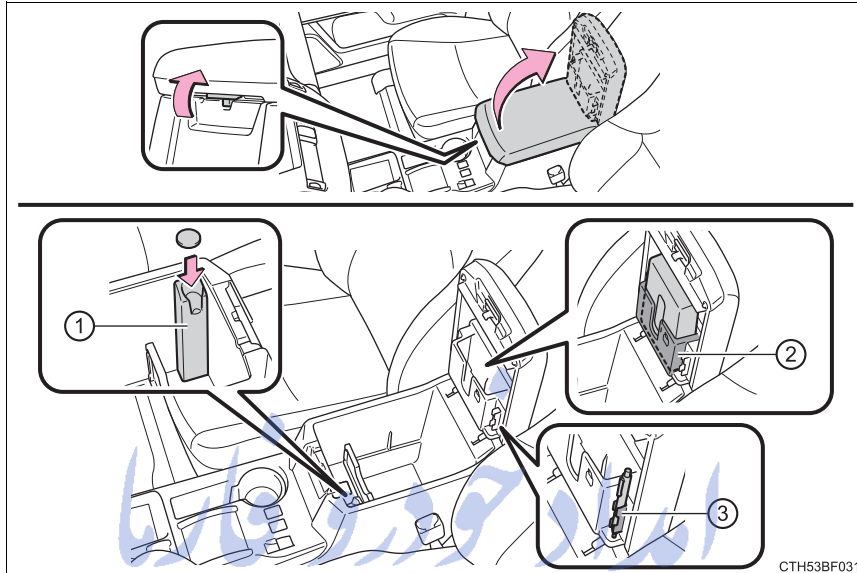

Lift the lid while pulling up the knob to release the lock.

- ① Coin holder
- ② Tissue pocket
- ③ Pen holder

تلفن شبانه روزی: ۰۱۵-۸۸۶۲۰۸۱

FarmaSOS.com

### Bottle holders

► Front seats

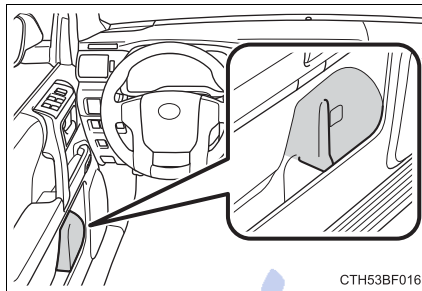

► Rear seats (without third row seats)/second row seats (with third row seats)

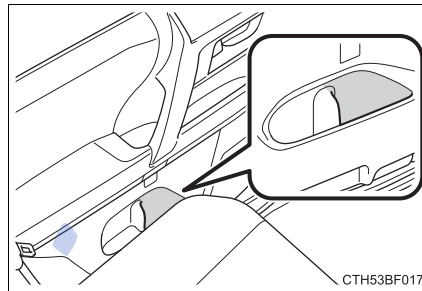

■ **When using the bottle holder**

- When storing a bottle, close the cap.
- The bottle may not be stored depending on its size or shape.

**⚠ CAUTION**

■ **Items unsuitable for the bottle holder**

Do not place anything other than a bottle in the bottle holders. Other items may be thrown out of the holders in the event of an accident or sudden braking and cause injury.

**⚠ NOTICE**

■ **Items that should not be stowed in the bottle holders**

Put the cap on before stowing a bottle. Do not place open bottles in the bottle holders, or glasses and paper cups containing liquid. The contents may spill and glasses may break.

## Luggage compartment features

### ■ Cargo hooks

#### ▶ Vehicles with third seats

1 Fold down the third seats. (→P. 131)

2 Raise the hook to use.

The cargo hooks are provided for securing loose items.

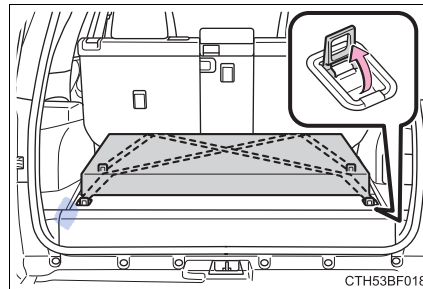

#### ▶ Vehicles without third seats

Raise the hook to use.

The cargo hooks are provided for securing loose items.

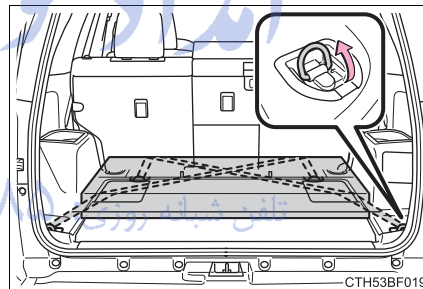

■ **Cargo net hooks**

The cargo net itself is not included as original equipment.

▶ **Vehicles with third seats (pattern 1)**

Raise the rear cargo hook to use.

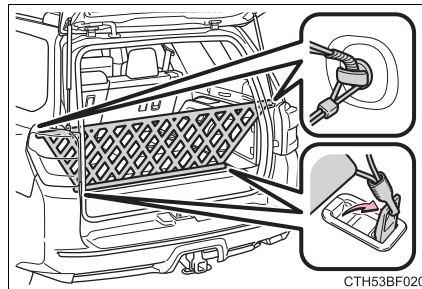

▶ **Vehicles with third seats (pattern 2)**

- 1 Fold down the third seats. (→P. 131)
- 2 Raise the cargo hook to use.

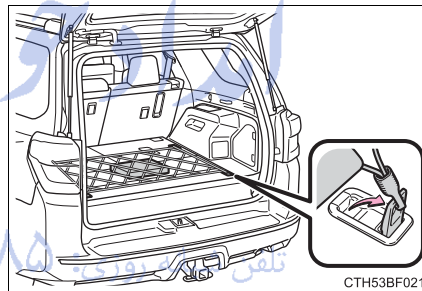

▶ **Vehicles without third seats (pattern 1)**

Raise the rear cargo hook to use.

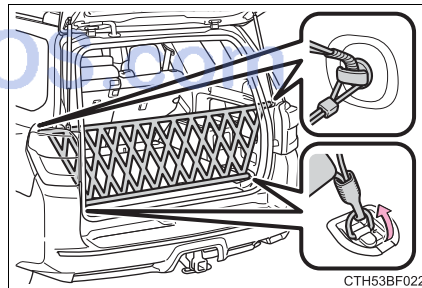



▶ Vehicles without third seats (pattern 2)

Raise the cargo hook to use.

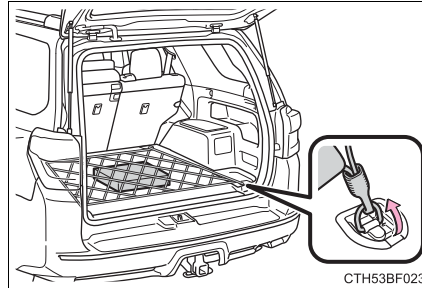

■ Storage compartment

▶ Type A (if equipped)

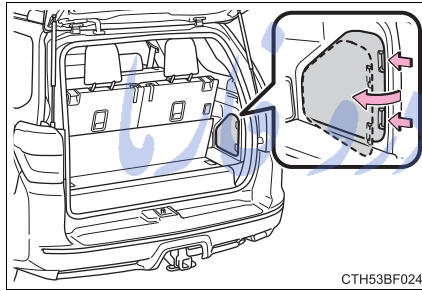

▶ Type B (if equipped)

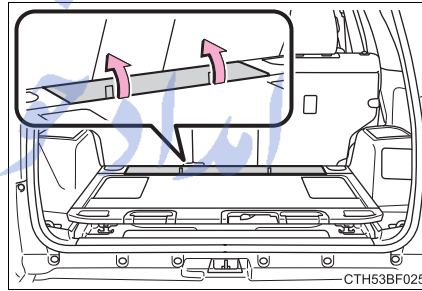

Open the storage compartment as shown.

تلفن شبانه روزی: ۰۲۱-۸۸۸۶۰۸۵

FarmaSOS.com

■ **Slide deck (if equipped)**

Slide the deck while turning the lock release lever, and then release the lever after sliding the deck to the lock position.

- ① Half-slide locked position
- ② Full-slide locked position

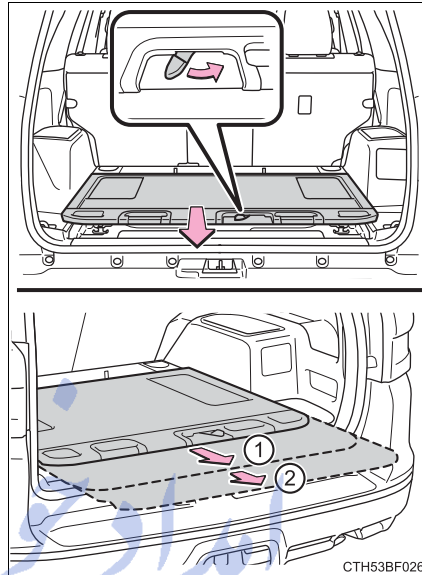

■ **Grocery bag hooks**

▶ Type A

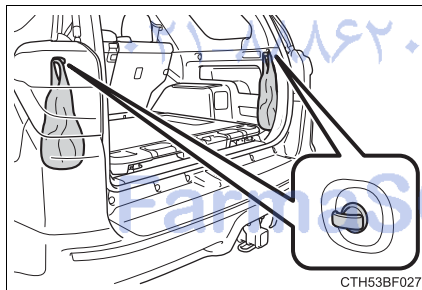

▶ Type B (if equipped)

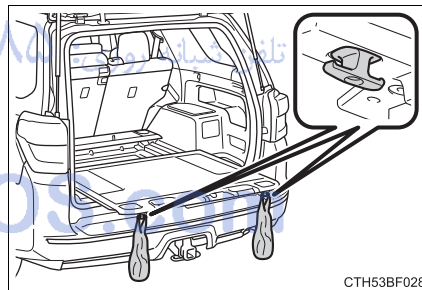

Type B only: To use the grocery bag hooks, slide the slide deck to the full-slide locked position. (→P. 308)

 CAUTION

■ **When the cargo hooks are not in use**

To avoid injury, always return the cargo hooks to their stowed positions.

■ **Slide deck operating precaution (if equipped)**

- Be careful not to get hands or feet pinched by the slide deck.
- Be careful not to allow the slide deck to hit any persons or luggage while sliding the deck.
- Do not operate the slide deck while someone is on it. Doing so may cause an accident.
- If operating the slide deck when the vehicle is stopped on an incline, the slide deck may move faster. Be careful not to allow the slide deck to hit you or pinch your fingers etc.
- After sliding the deck, make sure it is securely locked in position.
- Do not close the back door while any person is sitting on the slide deck or any person is between the slide deck and back door.
- Do not stow any objects into the space between the slide deck rails.

 NOTICE

■ **To prevent damage to the cargo net hooks**

Avoid hanging things other than a cargo net on them.

■ **Slide deck weight capacity (if equipped)**

Do not load anything heavier than 440 lb. (200 kg) on the sliding deck.

■ **Grocery bag hook weight capacity**

Do not hang any object heavier than 8.8 lb. (4 kg) on the grocery bag hooks.

■ **When using the slide deck (if equipped)**

- Do not close the back door while the slide deck is sliding out. Doing so may cause the back door or slide deck to break.
- If operating the slide deck when the vehicle is stopped on an incline, the slide deck may move faster. Be careful as luggage may become damaged or fly out and damage the cabin.

## Other interior features

### Sun visors

- ① To set the visor in the forward position, flip it down.
- ② To set the visor in the side position, flip down, unhook, and swing it to the side.
- ③ To use the side extender, place the visor in the side position, then slide it backward.

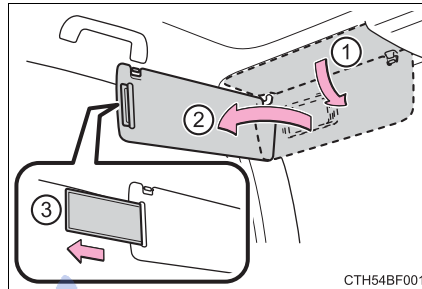

### Vanity mirrors

Slide the cover to open.

The light turns on when the cover is opened.

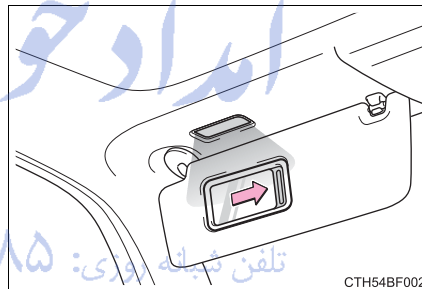

#### ⚠ NOTICE

#### ■ To prevent battery discharge

Do not leave the vanity lights on for extended periods while the engine is off.

## Clock

The clock can be adjusted by pressing the buttons.

- ① Adjusts the hours
- ② Adjusts the minutes

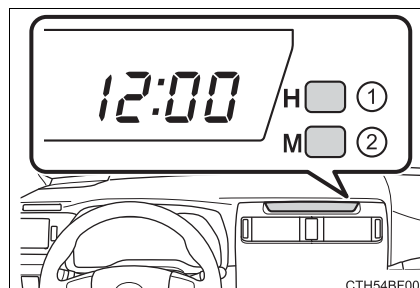

### ■ For quicker adjustment of the clock (Vehicles with Multi-terrain Select only)

To advance the minutes and hours quickly, press and hold the “M” or “H” button.

The time can be adjusted back or forth by following the procedure below:

The hour or minute can be moved forward or backward by pressing the “MODE/▼” or “SET/▲” button while pressing and holding the “H” or “M” button. If the “MODE/▼” or “SET/▲” button is also pressed and held in the above operation, the hour or minute will move faster.

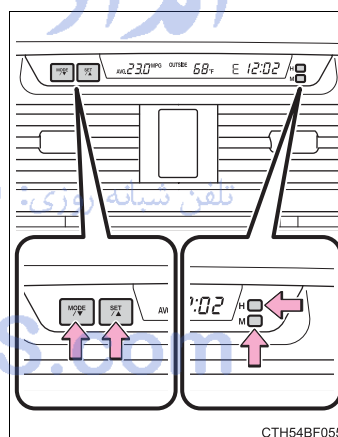

### ■ The clock is displayed when

- ▶ Vehicles without a smart key system

The engine switch is in the “ACC” or “ON” position.

- ▶ Vehicles with a smart key system

The engine switch is in ACCESSORY or IGNITION ON mode.

### ■ When disconnecting and reconnecting battery terminals

The clock data will be reset.

### Outside temperature display

The temperature display shows temperatures within the range of -40°F (-40°C) to 122°F (50°C).

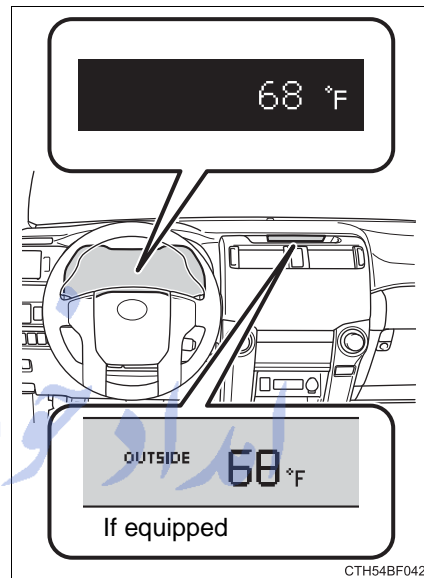

#### ■ The outside temperature is displayed when

- ▶ Vehicles without a smart key system

The engine switch is in the "ON" position.

- ▶ Vehicles with a smart key system

The engine switch is in IGNITION ON mode.

### ■ Ice indicator

If the outside temperature lowers to 37°F (3°C) or below when the engine switch is in the "ON" position (vehicles without a smart key system) or the engine switch is in IGNITION ON mode (vehicles with a smart key system), the indicator will come on to warn the driver that roads may be icy. Check the road surface and drive carefully. (The indicator will go off when the outside temperature rises to 41°F [5°C].)

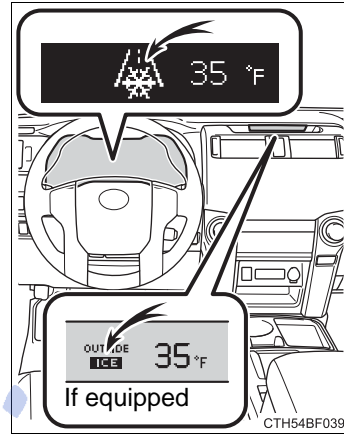

### ■ Display

In the following situations, the correct outside temperature may not be displayed, or the display may take longer than normal to change.

- When the vehicle is stopped, or moving at low speeds (less than 14 mph [24 km/h]).
- When the outside temperature has changed suddenly (at the entrance/exit of a garage, tunnel, etc.)

تلفن شبانه روزی: ۰۲۱-۸۸۶۲۰۸۵

FarmaSOS.com

### Power outlets (120 V AC) (If equipped)

The power outlet can be used for electrical appliances.

#### ► Main switch

To use the power outlet, turn on the main switch.

The power supply starts a few seconds after the main switch is pressed.

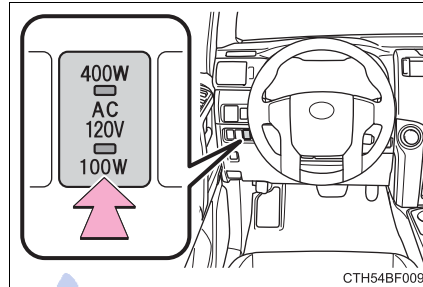

#### ► Power outlet socket (luggage compartment)

Open the lid.

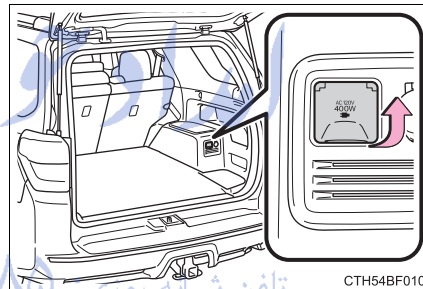

#### ■ Maximum available capacity of the power outlet

##### ● While the vehicle is being driven

The maximum capacity of the power outlet is always 120 V AC/100 W.

##### ● When the vehicle is stationary

The maximum capacity of the power outlet varies depending on the position of the shift lever.

- The maximum capacity is 120 V AC/100 W when the shift lever is in any position other than P or N.
- The maximum capacity is 120 V AC/400 W when the shift lever is in P or N.

The maximum capacity of 400 W can only be restored by turning the power outlet main switch off and then on again with the shift lever in P or N.



■ **The power outlet can be used when**

The engine is running.

■ **The indicator light changes according to the maximum available capacity as follows:**

- ① 120 V AC/400 W
- ② 120 V AC/100 W

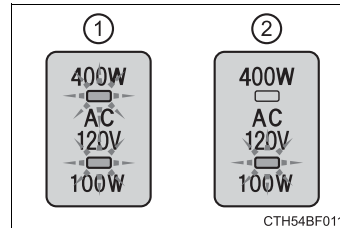

■ **When the power outlet is in operation**

The sound of the cooling fan may be heard from the right side of the luggage compartment. This is normal and does not indicate a malfunction.

■ **If the engine is started with the power outlet main switch on**

The maximum capacity of the power supply may decrease below the standard, or may be cut off completely, even when the vehicle is stationary.

■ **The protection circuit may be activated to cut the power supply if any of the following conditions apply:**

- The engine is started with the power outlet main switch on.
- Use of electrical appliances exceeding the maximum capacity is attempted. A sound may be heard when the protection circuit is activated. This is normal and does not indicate a malfunction.
- Electrical appliances, which consume power exceeding 100 W, have been used continuously for a long time period.
- The total power usage by all electrical features (headlights, air conditioning, etc.) has exceeded the total vehicle maximum for an extended period of time.

■ **If the protection circuit is activated and the power supply is cut, conduct the following procedure:**

- 1 Park the vehicle in a safe place, and then securely apply the parking brake.
- 2 Check and ensure that the shift lever is in P or N.
- 3 Make sure that the power consumption of the electric appliance is within the maximum capacity of the power outlet and the appliance is not broken.
- 4 Press the power outlet main switch again.

When the cabin temperature is high, open the windows to cool the temperature down. Once it reaches the normal temperature, turn the power outlet main switch on again.

If the power supply does not resume even after the above procedure has been performed, have the vehicle inspected by your Toyota dealer.

امداد خودرو فارما

تلفن شبانه روزی: ۰۲۱-۸۸۸۶۲۰۸۵

FarmaSOS.com

 CAUTION

**■ Using a power outlet**

Observe the following precautions to reduce the risk of injury.

- Use of the power outlet when it is wet with water or snow may result in electrical shocks and is extremely dangerous. The power outlet must be thoroughly dried before use.
- Do not allow children to use or play with the power outlet.
- Be careful not to get any part of your body caught in the power outlet lid.
- When using electrical appliances, strictly follow any cautions and notices written on their labels and in the manufacturers' instruction manuals.
- Do not modify, disassemble or repair the power outlet or its inverter in any way. Doing so may result in unexpected malfunctions or accidents, which could cause serious damage or injuries. Contact your Toyota dealer for any necessary repairs.

**■ To prevent injuries and accidents, secure all electric appliances before use and do not use any appliances that may do any of the following:**

- Distract the driver while driving, or hamper safe driving.
- Result in a fire or burn injuries due to the appliance rolling, falling or overheating while driving.
- Emit steam while the windows of the cabin are closed.

**■ To prevent unexpected accidents, such as electric shocks, do not perform any of the following actions:**

- Using the power outlet for electric heaters while sleeping.
- Contaminating the power outlet with liquid substances or mud.
- Handling electrical appliance plugs at the power outlet with wet hands or feet.
- Inserting foreign objects into the power outlet.
- Using malfunctioning electric appliances.
- Inserting inappropriate or badly fitting plugs into the power outlet.

 NOTICE**■ To avoid damaging the power outlet and the plug**

- Close the power outlet lid when not in use.
- Do not allow foreign objects or liquids to enter the power outlet, as this may cause a short circuit.
- Do not use plug adaptors to connect too many plugs to the power outlet.
- After removing a plug, gently close the power outlet lid.

**■ To prevent the fuse from being blown**

Do not use a 120 V AC appliance that requires more than the maximum capacity of the power outlet. If a 120 V AC appliance that consumes more than the maximum capacity is used, the protection circuit will cut the power supply.

**■ Appliances that may not operate properly (120 V AC)**

The following 120 V AC appliances may not operate even if their power consumption is under maximum capacity.

- Appliances with high initial peak wattage
- Measuring devices that process precise data.
- Other appliances that require an extremely stable power supply

**■ To prevent battery discharge**

Turn off all the vehicle's electronic equipment and accessories, such as the headlights and air conditioning, when electrical appliances that consume in excess of 100 W are used continuously for long periods of time.

**■ To prevent any damage caused by heat**

- Do not use any electrical appliances that give off intense heat, such as toasters, in any locations including the internal or external trim, seats and deck.
- Do not use any electrical appliances that are easily affected by vibration or heat inside the vehicle. Vibration while driving, or the heat of the sun while parking, may result in damage to those electrical appliances.

 NOTICE

■ **If any electrical appliances are to be used while driving**

Securely fasten both the appliances and their cables to prevent them from falling or getting caught in any of the power train components.

■ **If the power outlet is loose when an electrical appliance plug is connected**

Replace the outlet. Contact your Toyota dealer for any necessary replacements.

■ **If the power outlet gets dirty**

Turn the main switch off and use a soft, clean cloth to wipe it gently. Do not use any cleansing materials, such as organic solvents, wax, or compound cleaners, as these may damage the power outlet or cause it to malfunction.

### Power outlets

Please use as a power supply for electronic goods that use less than 12 VDC / 10 A (power consumption of 120 W).

When using electronic goods, make sure that the power consumption of all the connected power outlets is less than 120 W.

► Center panel

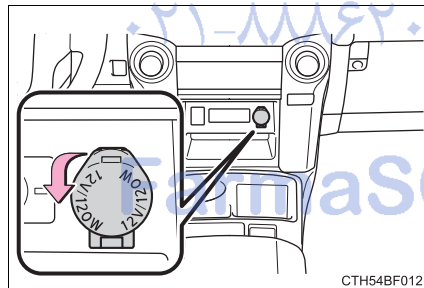

► Console box (outside)

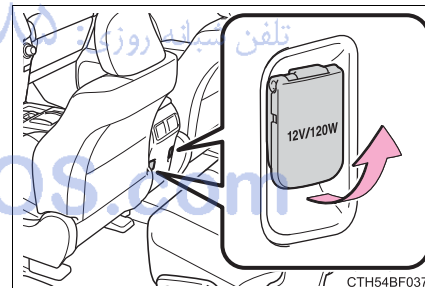

Open the lid.

► Console box (inside)

- 1 Lift the lid while pulling up the knob to release the lock.

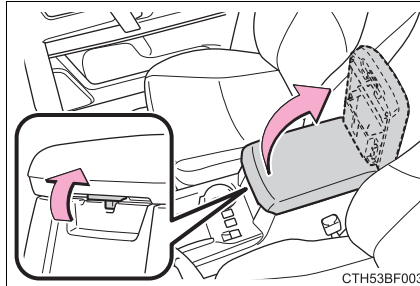

- 2 Open the lid.

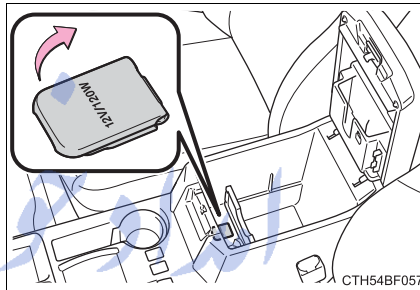

► Luggage compartment (vehicles without the 120 V AC)

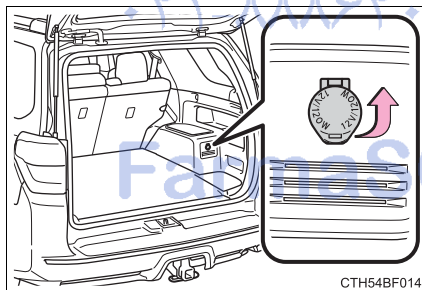

► Luggage compartment (vehicles with the 120 V AC)

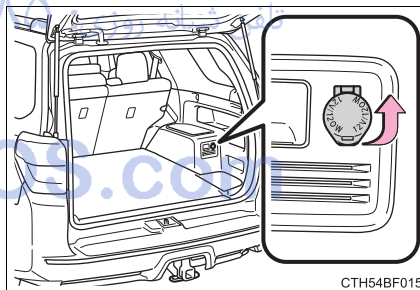

Open the lid.

#### ■ The power outlets can be used when

- ▶ Vehicles without a smart key system

The engine switch is in the “ACC” or “ON” position.

- ▶ Vehicles with a smart key system

The engine switch is in ACCESSORY or IGNITION ON mode.

#### ⚠ NOTICE

##### ■ To avoid damaging the power outlets

Close the power outlet lids when the power outlets are not in use.

Foreign objects or liquids that enter the power outlets may cause a short circuit.

##### ■ To prevent battery discharge

Do not use the power outlets longer than necessary when the engine is off.

#### Armrest

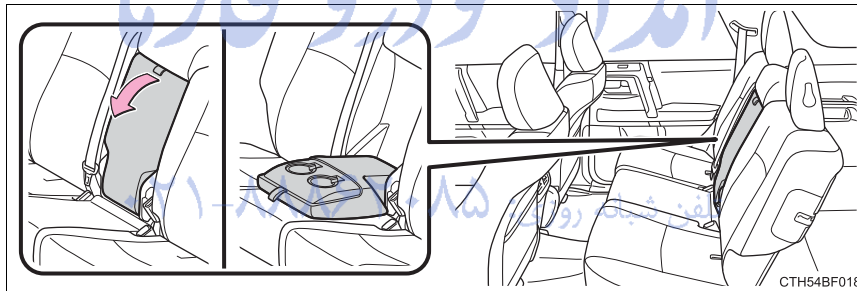

Pull down the armrest for use.

#### ⚠ NOTICE

Do not apply too much load on the armrest.

### Assist grips

An assist grip (type A) installed on the ceiling can be used to support your body while sitting on the seat.

An assist grip (type B) installed on the pillar can be used when getting in or out of the vehicle and others.

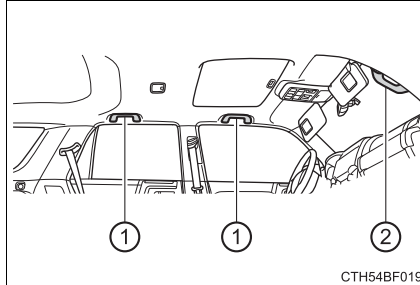

- ① Assist grip (type A)
- ② Assist grip (type B)

#### ⚠ CAUTION

##### ■ Assist grip (type A)

Do not use the assist grip (type A) when getting in or out of the vehicle or rising from your seat.

#### ⚠ NOTICE

Do not hang any heavy object or put a heavy load on the assist grip.

FarmaSOS.com



## Garage door opener\*

The garage door opener can be programmed to operate garage doors, gates, entry doors, door locks, home lighting systems, security systems, and other devices.

The garage door opener (HomeLink® Universal Transceiver) is manufactured under license from HomeLink®.

### Programming the HomeLink®

The HomeLink® compatible transceiver in your vehicle has 3 buttons which can be programmed to operate 3 different devices. Refer to the programming method below appropriate for the device.

- ① HomeLink® Indicator light
- ② Garage door operation indicators (→P. 327)
- ③ Buttons

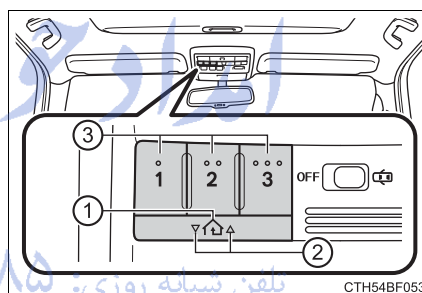

#### ■ Before programming HomeLink®

- During programming, it is possible that garage doors, gates, or other devices may operate. For this reason, make sure that people and objects are clear of the garage door or other devices to prevent injury or other potential harm.
- It is recommended that a new battery be placed in the remote control transmitter for more accurate programming.
- Garage door openers manufactured after 1995 may be equipped with rolling code protection. If this is the case, you will need a step-ladder or other sturdy, safe device to reach the “learn” or “smart” button on the garage door opener motor.

\*: If equipped

### ■ Programming HomeLink®

- 1 Point the remote control transmitter for the device 1 to 3 in. (25 to 75 mm) from the HomeLink® buttons.

Keep the HomeLink® indicator light in view while programming.

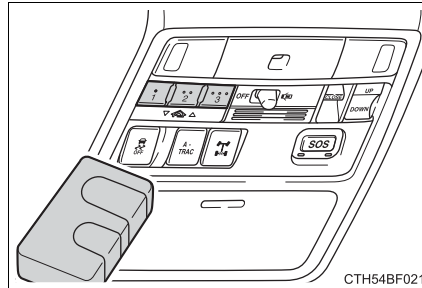

#### ► For U.S.A. owner's

- 2 Press and hold the HomeLink® button you want to program and the handheld transmitter button simultaneously. When the HomeLink® indicator light changes from slowly flashing orange to rapidly flashing green (rolling code) or continuously lit green (fixed code), release both buttons.

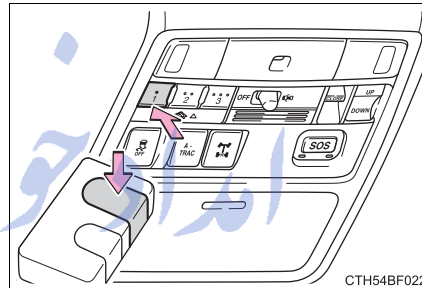

#### ► Programming an entry gate (for U.S.A. owners)/Programming a device in the Canadian market

- 2 With one hand, press and hold the HomeLink® button you want to program. With your other hand, press and release the remote control transmitter every 2 seconds and repeat this cycle until the HomeLink® indicator light starts to flash rapidly. Then, release the buttons.

- 3 Test the HomeLink<sup>®</sup> operation by pressing the newly programmed button and observing the indicator light:
  - If the indicator light is solid/continuous, programming has been completed and your device should activate when the HomeLink<sup>®</sup> button is pressed and released.
  - If the indicator light blinks rapidly for 2 seconds and then turns into a solid/continuous light, proceed to the heading “Programming a rolling code system”.
- 4 Repeat the steps above to program another device for any of the remaining HomeLink<sup>®</sup> buttons.

#### ■ Programming a rolling code system

- 1 Locate the “learn” or “smart” button on the garage door opener motor in the garage.

This button can usually be found where the hanging antenna wire is attached to the unit. The name and color of the button may vary by manufacturer. Please refer to the owner’s manual supplied with the garage door opener motor for details.

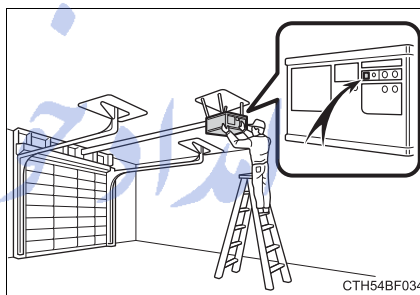

- 2 Press and release the “learn” or “smart” button. Perform 3 within 30 seconds after performing 2.

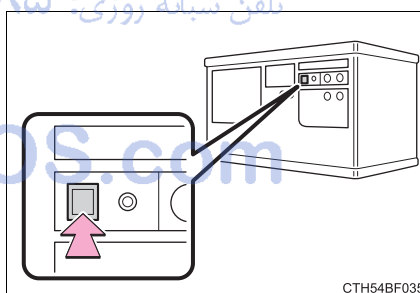

- 3 Press and hold the programmed HomeLink<sup>®</sup> button (located inside the vehicle) for 2 seconds and release it. Repeat this sequence (press/hold/release) up to 3 times to complete programming.

If the garage door opener motor activates when the HomeLink<sup>®</sup> button is pressed, the garage door opener motor recognizes the HomeLink<sup>®</sup> signal.

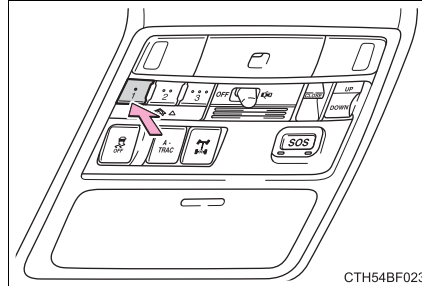

#### ■ Enabling 2-way communication with a garage door (only available for compatible devices)

When enabled, 2-way communication allows you to check the status of the opening and closing of the garage door through indicators in your vehicle.

2-way communication is only available if the garage door opener motor used is a compatible device. (To check device compatibility, refer to the owner's manual supplied with the garage door opener motor.)

- 1 Press a programmed HomeLink<sup>®</sup> button to operate a garage door.
- 2 Within 1 minute of pressing the HomeLink<sup>®</sup> button, after the garage door operation has stopped, press the "learn" or "smart" button on the garage door opener motor. Within 5 seconds of the establishment of 2-way communication with the garage door opener, both garage door operation indicators in the vehicle will flash rapidly (green).

#### ■ Reprogramming a single HomeLink<sup>®</sup> button

When the following procedure is performed, buttons which already have devices registered to them can be overwritten:

- 1 With one hand, press and hold the desired HomeLink<sup>®</sup> button.
- 2 When the HomeLink<sup>®</sup> indicator starts flashing, continue to hold the HomeLink<sup>®</sup> button and perform "Programming HomeLink<sup>®</sup>" from 1 (it takes 20 seconds for the HomeLink<sup>®</sup> indicator to start flashing).

### Operating HomeLink®

Press the appropriate HomeLink® button. The HomeLink® indicator light should turn on.

### Garage door operation indicators

The status of the opening and closing of a garage door is shown by the indicators.

- ① Opening
- ② Closing

This function is only available if the garage door opener motor used is a compatible device. (To check device compatibility, refer to the owner's manual supplied with the garage door opener motor.)

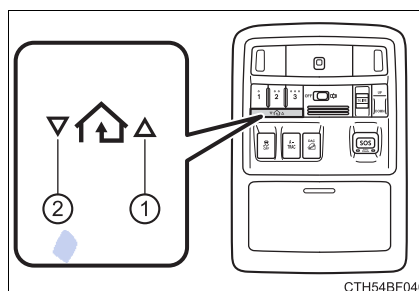

Color	Status
Orange (flashing)	Currently opening/closing
Green	Opening/closing has completed
Red (flashing)	Feedback signals cannot be received

The indicators can operate within approximately 820 ft. (250 m) of the garage door. However, if there are obstacles between the garage door and the vehicle, such as houses and trees, feedback signals from the garage door may not be received.

To recall the previous door operation status, press and release either HomeLink® buttons “1” and “2” or “2” and “3” simultaneously for 2 seconds. The last recorded status will be displayed for 5 seconds.

### Erasing the entire HomeLink® memory (all three programs)

Press and hold the 2 outside buttons for 10 seconds until the HomeLink® indicator light changes from continuously lit (orange) to rapidly flashing (green).

If you sell your vehicle, be sure to erase the programs stored in the HomeLink® memory.

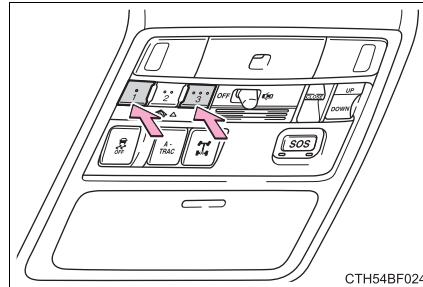

### Programs stored in the HomeLink® memory

- The registered codes are not erased even if the 12-volt battery cable is disconnected.
- If learning failed when registering a different code to a HomeLink® button that already has a code registered to it, the already registered code is not erased.

### Before programming

- Install a new battery in the transmitter.
- The battery side of the transmitter must be pointed away from the HomeLink®.

### Certification for the garage door opener

This device complies with FCC rules part 15 and Industry Canada RSS-210.

Operation is subject to the following two conditions: (1) This device may not cause harmful interference, and (2) This device must accept any interference that may be received including interference that may cause undesired operation.

#### WARNING:

The transmitter has been tested and complies with FCC and IC rules. Changes or modifications not expressly approved by the party responsible for compliance could void the user's authority to operate the device.

The term "IC:" before the certification/registration number only signifies that Industry Canada technical specifications were met.

IC: 279B-775AHL5 MODEL/FCC ID: CB2775AHL5

### For additional programming assistance with your HomeLink® Universal Transceiver

Visit on the web at [www.homelink.com](http://www.homelink.com) or call 1-800-355-3515.

**⚠ CAUTION****■ When programming a garage door or other remote control device**

The garage door may operate, so ensure people and objects are out of danger to prevent potential harm.

**■ Conforming to federal safety standards**

Do not use the HomeLink® Compatible Transceiver with any garage door opener or device that lacks safety stop and reverse features as required by federal safety standards.

This includes any garage door that cannot detect an obstruction object. A door or device without these features increases the risk of death or serious injury.

**■ When operating or programming HomeLink®**

Never allow a child to operate or play with the HomeLink® buttons.

امداد خودرو فارما

تلفن شبانه روزی: ۰۲۱-۸۸۸۶۲۰۸۵

FarmaSOS.com

## Safety Connect\*

**Safety Connect is a subscription-based telematics service that uses Global Positioning System (GPS) data and embedded cellular technology to provide safety and security features to subscribers. Safety Connect is supported by Toyota's designated response center, which operates 24 hours per day, 7 days per week.**

**Safety Connect service is available by subscription on select, telematics hardware-equipped vehicles.**

**By using the Safety Connect service, you are agreeing to be bound by the Telematics Subscription Service Agreement and its Terms and Conditions, as in effect and amended from time to time, a current copy of which is available at Toyota.com. All use of the Safety Connect service is subject to such then-applicable Terms and Conditions.**

### ■ System components

- ① Microphone
- ② "SOS" button
- ③ LED light indicators

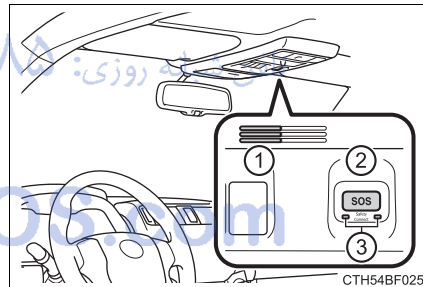

\*: If equipped



### ■ Services

Subscribers have the following Safety Connect services available:

- Automatic Collision Notification\*  
Helps drivers receive necessary response from emergency service providers. (→P. 332)  
\*: U.S. Patent No. 7,508,298 B2
- Stolen Vehicle Location  
Helps drivers in the event of vehicle theft. (→P. 333)
- Emergency Assistance Button (SOS)  
Connects drivers to response-center support. (→P. 333)
- Enhanced Roadside Assistance  
Provides drivers various on-road assistance. (→P. 333)

### ■ Subscription

After you have signed the Telematics Subscription Service Agreement and are enrolled, you can begin receiving services.

A variety of subscription terms is available for purchase. Contact your Toyota dealer, call 1-800-331-4331, or push the “SOS” button in your vehicle for further subscription details.

### ■ Safety Connect Services Information

- Phone calls using the vehicle's Bluetooth® technology will not be possible during Safety Connect.
- Safety Connect is available beginning Fall 2009 on select Toyota models. Contact with the Safety Connect response center is dependent upon the telematics device being in operative condition, cellular connection availability, and GPS satellite signal reception, which can limit the ability to reach the response center or receive emergency service support. Enrollment and Telematics Subscription Service Agreement required. A variety of subscription terms is available; charges vary by subscription term selected.
- Automatic Collision Notification, Emergency Assistance, Stolen Vehicle Location, and Enhanced Roadside Assistance will function in the United States, including Hawaii and Alaska, and in Canada. No Safety Connect services will function outside of the United States in countries other than Canada.
- Safety Connect services are not subject to section 255 of the Telecommunications Act and the device is not TTY compatible.

### ■ Languages

The Safety Connect response center will offer support in multiple languages. The Safety Connect system will offer voice prompts in English and Spanish. Please indicate your language of choice when enrolling.

### ■ When contacting the response center

You may be unable to contact the response center if the network is busy.

### **Safety Connect LED light Indicators**

When the engine switch is turned to the “ON” position (vehicles without a smart key system) or the engine switch is turned to IGNITION ON mode (vehicles with a smart key system), the red indicator light comes on for 2 seconds then turns off. Afterward, the green indicator light comes on, indicating that the service is active.

The following indicator light patterns indicate specific system usage conditions:

- Green indicator light on = Active service
- Green indicator light flashing = Safety Connect call in process
- Red indicator light (except at vehicle start-up) = System malfunction (contact your Toyota dealer)
- No indicator light (off) = Safety Connect service not active

### **Safety Connect services**

#### **■ Automatic Collision Notification**

In case of either airbag deployment or severe rear-end collision, the system is designed to automatically call the response center. The responding agent receives the vehicle’s location and attempts to speak with the vehicle occupants to assess the level of emergency. If the occupants are unable to communicate, the agent automatically treats the call as an emergency, contacts the nearest emergency services provider to describe the situation, and requests that assistance be sent to the location.

FarmaSOS.com

**■ Stolen Vehicle Location**

If your vehicle is stolen, Safety Connect can work with local authorities to assist them in locating and recovering the vehicle. After filing a police report, call the Safety Connect response center at 1-800-331-4331 and follow the prompts for Safety Connect to initiate this service.

In addition to assisting law enforcement with recovery of a stolen vehicle, Safety-Connect-equipped vehicle location data may, under certain circumstances, be shared with third parties to locate your vehicle. Further information is available at Toyota.com.

**■ Emergency Assistance Button (“SOS”)**

In the event of an emergency on the road, push the “SOS” button to reach the Safety Connect response center. The answering agent will determine your vehicle’s location, assess the emergency, and dispatch the necessary assistance required.

If you accidentally press the “SOS” button, tell the response-center agent that you are not experiencing an emergency.

**■ Enhanced Roadside Assistance**

Enhanced Roadside Assistance adds GPS data to the already included warranty-based Toyota roadside service.

Subscribers can press the “SOS” button to reach a Safety Connect response-center agent, who can help with a wide range of needs, such as: towing, flat tire, fuel delivery, etc. For a description of the Enhanced Roadside Assistance services and their limitations, please see the Safety Connect Terms and Conditions, which are available at Toyota.com.

---

**Safety information for Safety Connect**

Important! Read this information before using Safety Connect.

**■ Exposure to radio frequency signals**

The Safety Connect system installed in your vehicle is a low-power radio transmitter and receiver. It receives and also sends out radio frequency (RF) signals.

In August 1996, the Federal Communications Commission (FCC) adopted RF exposure guidelines with safety levels for mobile wireless phones. Those guidelines are consistent with the safety standards previously set by the following U.S. and international standards bodies.

- ANSI (American National Standards Institute) C95.1 [1992]
- NCRP (National Council on Radiation Protection and Measurement) Report 86 [1986]
- ICNIRP (International Commission on Non-Ionizing Radiation Protection) [1996]

Those standards were based on comprehensive and periodic evaluations of the relevant scientific literature. Over 120 scientists, engineers, and physicians from universities, and government health agencies and industries reviewed the available body of research to develop the ANSI Standard (C95.1).

The design of Safety Connect complies with the FCC guidelines in addition to those standards.

---

**■ Certification for Safety Connect**

FCC ID: N7NGTM2

FCC ID: O6Y-CDMRF101

NOTE:

This device complies with Part 15 of the FCC Rules. Operation is subject to the following two conditions: (1) This device may not cause harmful interference, and (2) this device must accept any interference received, including interference that may cause undesired operation.

FCC WARNING:

Changes or modifications not expressly approved by the party responsible for compliance could void the user's authority to operate the equipment.

## Compass\*

The compass on the accessory meter display indicates the direction in which the vehicle is heading.

- ① “MODE/▼” button
- ② “SET/▲” button
- ③ Direction display

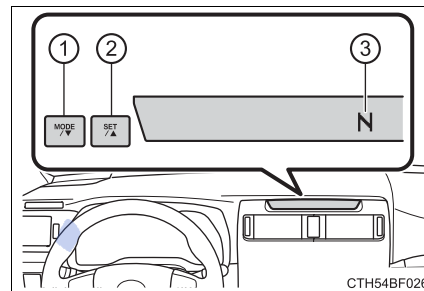

### ■ Displays and directions

Display	Direction
“N”	North
“NE”	Northeast
“E”	East
“SE”	Southeast
“S”	South
“SW”	Southwest
“W”	West
“NW”	Northwest

\*: If equipped

### Calibrating the compass

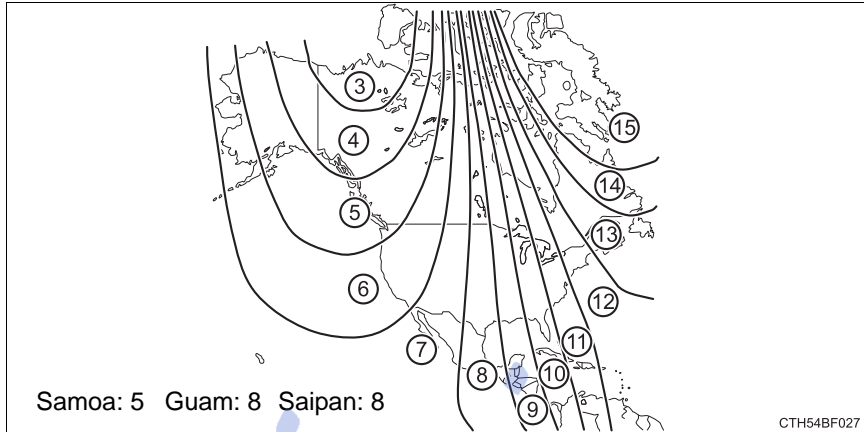

The direction display deviates from the true direction determined by the earth's magnetic field. The amount of deviation varies depending on the geographic position of the vehicle.

If you cross over one of the map boundaries shown in illustration, the compass will deviate.

To obtain higher precision or perfect calibration, refer to "Deviation calibration".

تلفن شبانه روزی: ۰۲۱-۸۸۸۶۲۰۸۵

FarmaSOS.com

### ■ Deviation calibration

- 1 Stop the vehicle.
- 2 Change the accessory meter display to deviation calibration mode by doing the following.

When the parking lights are turned on:

Press and hold the “MODE/▼” button.

A number (1 to 15) will appear on the display.

When the parking lights are off:

In accessory meter light control mode (→P. 90), press and hold the “MODE/▼” button.

A number (1 to 15) will appear on the display.

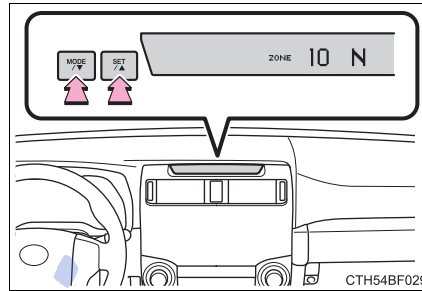

- 3 Referring to the map above, press the “MODE/▼” or “SET/▲” button to select the number of the zone you are in.
- 4 Press and hold the “SET/▲” button to confirm the number and to exit deviation calibration mode. (If the button is pressed for more than 6 seconds, the number will automatically be confirmed and the display returned to normal.)

### ■ Circling calibration

If “•” appears on the left side of the direction display, circling calibration needs to be performed.

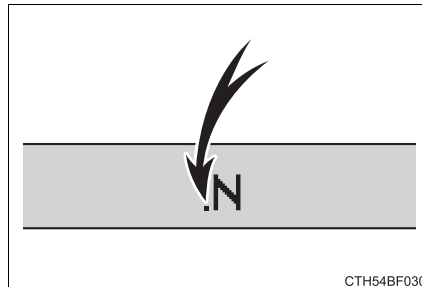

CTH54BF030

- 1 Stop the vehicle in a place where it is safe to drive in a circle.

- 2 In deviation calibration mode (→P. 337), press and hold the “MODE/▼” button to change to circling calibration mode.

“•” on the left side of the direction display will blink.

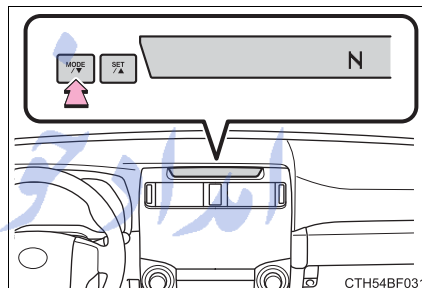

CTH54BF031

- 3 Drive the vehicle in a circle completing at least one full circle within 20 - 120 seconds.

If there is not enough space to drive in a circle, drive around the block until a direction is displayed.



CTH54BF032

- 4 Press and hold the “SET/▲” button to confirm the direction and to exit circling calibration mode. (If the button is pressed for several minutes, the direction will automatically be confirmed and the display returned to normal.)
- 5 Make sure that “•” on the left side of the direction display has gone off. If “•” is illuminated, perform the above procedure again.



#### ■ Conditions unfavorable to correct operation

The compass may not show the correct direction in the following conditions:

- The vehicle is stopped immediately after turning.
- The vehicle is on an inclined surface.
- The vehicle is in a place where the earth's magnetic field is subject to interference by artificial magnetic fields (underground car park/parking lot, under a steel tower, between buildings, roof car park/parking lot, near an intersection, near a large vehicle, etc.).
- The vehicle has become magnetized.  
(There is a magnet or metal object near the accessory meter display.)
- The battery has been disconnected.
- A door is open.

#### ■ Circling calibration error message

In the following situations, an error message regarding the circling calibration will appear on the accessory meter display for a few seconds:

- The vehicle was driven too fast during the circling calibration.
- The circling calibration was not completed successfully within about two minutes.

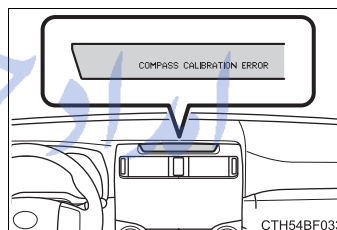

#### ⚠ CAUTION

##### ■ While driving the vehicle

Do not adjust the display. Adjust the display only when the vehicle is stopped.

##### ■ When doing the circling calibration

Secure a wide space, and watch out for people and vehicles in the vicinity. Do not violate any local traffic rules while performing circling calibration.



## NOTICE

**■ To avoid compass malfunctions**

Do not place magnets or any metal objects near the accessory meter display.

Doing this may cause the compass sensor to malfunction.

**■ To ensure normal operation of the compass**

● Do not perform a circling calibration of the compass in a place where the earth's magnetic field is subject to interference by artificial magnetic fields.

● During calibration, do not operate electric systems (moon roof, power windows, etc.) as they may interfere with the calibration.

امداد خودرو فارما

تلفن شبانه روزی: ۰۲۱-۸۸۸۶۲۰۸۵

FarmaSOS.com

<b>6-1. Maintenance and care</b>	
Cleaning and protecting the vehicle exterior.....	342
Cleaning and protecting the vehicle interior.....	344
<b>6-2. Maintenance</b>	
Maintenance requirements.....	347
General maintenance.....	349
Emission inspection and maintenance (I/M) programs.....	352
<b>6-3. Do-it-yourself maintenance</b>	
Do-it-yourself service precautions .....	353
Hood .....	356
Engine compartment.....	357
Tires.....	372
Tire inflation pressure .....	377
Wheels .....	380
Air conditioning filter.....	383
Wireless remote control/ electronic key battery .....	385
Checking and replacing fuses .....	388
Light bulbs.....	391

## Cleaning and protecting the vehicle exterior

### Perform the following to protect the vehicle and maintain it in prime condition:

- Working from top to bottom, liberally apply water to the vehicle body, wheel wells and underside of the vehicle to remove any dirt and dust.
- Wash the vehicle body using a sponge or soft cloth, such as a chamois.
- For hard-to-remove marks, use car wash soap and rinse thoroughly with water.
- Wipe away any water.
- Wax the vehicle when the waterproof coating deteriorates.  
If water does not bead on a clean surface, apply wax when the vehicle body is cool.

#### ■ Automatic car washes

- Fold the mirrors before washing the vehicle. Start washing from the front of the vehicle. Make sure to extend the mirrors before driving.
- Brushes used in automatic car washes may scratch the vehicle surface and harm your vehicle's paint.
- In certain automatic car washes, the roof antenna (if equipped) or rear spoiler may interfere with machine operation. This may prevent the vehicle from being cleaned properly or result in damage to the antenna or rear spoiler.

#### ■ High pressure car washes

- Do not allow the nozzles of the car wash to come within close proximity of the windows.
- Before using the car wash, check that the fuel filler door on your vehicle is closed properly.

#### ■ Aluminum wheels (if equipped)

- Remove any dirt immediately by using a neutral detergent. Do not use hard brushes or abrasive cleaners. Do not use strong or harsh chemical cleaners.  
Use the same mild detergent and wax as used on the paint.
- Do not use detergent on the wheels when they are hot, for example after driving for long distance in the hot weather.
- Wash detergent from the wheels immediately after use.

### ■ Bumpers and side moldings

Do not scrub with abrasive cleaners.

#### ⚠ CAUTION

##### ■ When washing the vehicle

Do not apply water to the inside of the engine compartment. Doing so may cause the electrical components etc. to catch fire.

##### ■ Precautions regarding the exhaust pipe

Exhaust gases cause the exhaust pipe to become quite hot.

When washing the vehicle, be careful not to touch the pipe until it has cooled sufficiently, as touching hot exhaust pipe can cause burns.

#### ⚠ NOTICE

##### ■ To prevent paint deterioration and corrosion on the body and components (aluminum wheels etc.)

● Wash the vehicle immediately in the following cases:

- After driving near the sea coast
- After driving on salted roads
- If coal tar or tree sap is present on the paint surface
- If dead insects, insect droppings or bird droppings are present on the paint surface
- After driving in an area contaminated with soot, oily smoke, mine dust, iron powder or chemical substances
- If the vehicle becomes heavily soiled with dust or mud
- If liquids such as benzene and gasoline are spilled on the paint surface

● If the paint is chipped or scratched, have it repaired immediately.

● To prevent the wheels from corroding, remove any dirt and store in a place with low humidity when storing the wheels.

##### ■ Cleaning the exterior lights

● Wash carefully. Do not use organic substances or scrub with a hard brush. This may damage the surfaces of the lights.

● Do not apply wax to the surfaces of the lights. Wax may cause damage to the lenses.

##### ■ High pressure car washes (vehicles with rear view monitor system)

When washing the vehicle, do not apply intensive bursts of water to the camera or camera area. Doing so may result in the camera malfunctioning.

## Cleaning and protecting the vehicle interior

**The following procedures will help protect your vehicle's interior and keep it in top condition:**

### Protecting the vehicle interior

Remove dirt and dust using a vacuum cleaner. Wipe dirty surfaces with a cloth dampened with lukewarm water.

### Cleaning the leather areas

- Remove dirt and dust using a vacuum cleaner.
- Wipe off any excess dirt and dust with a soft cloth dampened with diluted detergent.  
Use a diluted water solution of approximately 5% neutral wool detergent.
- Wring out any excess water from the cloth and thoroughly wipe off all remaining traces of detergent.
- Wipe the surface with a dry, soft cloth to remove any remaining moisture. Allow the leather to dry in a shaded and ventilated area.

### Cleaning the synthetic leather areas

- Remove loose dirt using a vacuum cleaner.
- Apply a mild soap solution to the synthetic leather using a sponge or soft cloth.
- Allow the solution to soak in for a few minutes. Remove the dirt and wipe off the solution with a clean, damp cloth.

**■ Caring for leather areas**

Toyota recommends cleaning the interior of the vehicle at least twice a year to maintain the quality of the vehicle's interior.

**■ Shampooing the carpets**

There are several commercial foaming-type cleaners available. Use a sponge or brush to apply the foam. Rub in overlapping circles. Do not use water. Wipe dirty surfaces and let them dry. Excellent results are obtained by keeping the carpet as dry as possible.

**■ Seat belts**

Clean with mild soap and lukewarm water using a cloth or sponge. Also check the belts periodically for excessive wear, fraying or cuts.

**⚠ CAUTION****■ Water in the vehicle**

- Do not splash or spill liquid in the vehicle.  
Doing so may cause electrical components etc. to malfunction or catch fire.
- Do not get any of the SRS components or wiring in the vehicle interior wet.  
(→P. 36)  
An electrical malfunction may cause the airbags to deploy or not function properly, resulting in death or serious injury.

**■ Cleaning the interior (especially instrument panel)**

Do not use polish wax or polish cleaner. The instrument panel may reflect off the windshield, obstructing the driver's view and leading to an accident, resulting in death or serious injury.

 NOTICE**■ Cleaning detergents**

- Do not use the following types of detergent, as they may discolor the vehicle interior or cause streaks or damage to painted surfaces:
  - Non-seat portions: Organic substances such as benzene or gasoline, alkaline or acidic solutions, dye, and bleach
  - Seats: Alkaline or acidic solutions, such as thinner, benzene, and alcohol
- Do not use polish wax or polish cleaner. The instrument panel's or other interior part's painted surface may be damaged.

**■ Preventing damage to leather surfaces**

Observe the following precautions to avoid damage to and deterioration of leather surfaces:

- Remove any dust or dirt from leather surfaces immediately.
- Do not expose the vehicle to direct sunlight for extended periods of time. Park the vehicle in the shade, especially during summer.
- Do not place items made of vinyl, plastic, or containing wax on the upholstery, as they may stick to the leather surface if the vehicle interior heats up significantly.

**■ Water on the floor**

Do not wash the vehicle floor with water.

Vehicle systems such as the audio system may be damaged if water comes into contact with electrical components such as the audio system above or under the floor of the vehicle. Water may also cause the body to rust.

**■ Cleaning the inside of the rear quarter windows and back window**

- Do not use glass cleaner to clean the rear quarter windows and back window, as this may cause damage to the rear window defogger heater wires or antenna. Use a cloth dampened with lukewarm water to gently wipe the window clean. Wipe the window in strokes running parallel to the heater wires or antenna.
- Be careful not to scratch or damage the heater wires or antenna.



## Maintenance requirements

**To ensure safe and economical driving, day-to-day care and regular maintenance are essential. It is the owner's responsibility to perform regular checks. Toyota recommends the following maintenance:**

### General maintenance

General maintenance should be performed on a daily basis. This can be done by yourself or by a Toyota dealer.

### Scheduled maintenance

Scheduled maintenance should be performed at specified intervals according to the maintenance schedule.

For details about maintenance items and schedules, refer to the "Scheduled Maintenance Guide" or "Owner's Manual Supplement".

### Do-it-yourself maintenance

You can perform some maintenance procedures by yourself.

Please be aware that do-it-yourself maintenance may affect warranty coverage.

The use of Toyota Repair Manuals is recommended.

For details about warranty coverage, refer to the separate "Owner's Warranty Information Booklet" or "Owner's Manual Supplement".

### Repair and replacement

It is recommended that genuine Toyota parts be used for repairs to ensure performance of each system. If non-Toyota parts are used in replacement or if a repair shop other than a Toyota dealer performs repairs, confirm the warranty coverage.

### ■ Reset the maintenance data (U.S.A. only)

After the required maintenance is performed according to the maintenance schedule, please reset the maintenance data.

To reset the data, follow the procedure described below:

- 1 Turn the engine switch off with the trip meter A reading shown. (→P. 83)
- 2 Vehicles without a smart key system:  
While pressing the display change button (→P. 83), turn the engine switch to the "ON" position (do not start the engine because reset mode will be canceled).  
Vehicles with a smart key system:  
While pressing the display change button (→P. 83), turn the engine switch to the IGNITION ON mode (do not start the engine because otherwise the reset mode will be canceled).
- 3 Continue to press and hold the button until the trip meter displays "000000".

### ■ Allow inspection and repairs to be performed by a Toyota dealer

- Toyota technicians are well-trained specialists and are kept up to date with the latest service information. They are well informed about the operations of all systems on your vehicle.
- Keep a copy of the repair order. It proves that the maintenance that has been performed is under warranty coverage. If any problem should arise while your vehicle is under warranty, your Toyota dealer will promptly take care of it.



### CAUTION

#### ■ If your vehicle is not properly maintained

Improper maintenance could result in serious damage to the vehicle and possible death or serious injury.

#### ■ Handling of the battery

- Engine exhaust, some of its constituents, and a wide variety of automobile components contain or emit chemicals known to the State of California to cause cancer and birth defects and other reproductive harm. Work in a well ventilated area.
- Oils, fuels and fluids contained in vehicles as well as waste produced by component wear contain or emit chemicals known to the State of California to cause cancer and birth defects or other reproductive harm. Avoid exposure and wash any affected area immediately.
- Battery posts, terminals and related accessories contain lead and lead compounds which are known to cause brain damage. Wash your hands after handling. (→P. 367)

## General maintenance

Listed below are the general maintenance items that should be performed at the intervals specified in the “Owner’s Warranty Information Booklet” or “Owner’s Manual Supplement/Scheduled Maintenance Guide”. It is recommended that any problem you notice should be brought to the attention of your Toyota dealer or qualified service shop for advice.

### Engine compartment

Items	Check points
Battery	Check the connections. (→P. 367)
Brake fluid	Is the brake fluid at the correct level? (→P. 364)
Engine coolant	Is the engine coolant at the correct level? (→P. 362)
Engine oil	Is the engine oil at the correct level? (→P. 359)
Exhaust system	There should not be any fumes or strange sounds.
Power steering fluid	Is the power steering fluid at the correct level? (→P. 366)
Radiator/condenser	The radiator and condenser should be free from foreign objects. (→P. 363)
Washer fluid	Is there sufficient washer fluid? (→P. 370)

FarmaSOS.com

**Vehicle interior**

Items	Check points
Accelerator pedal	<ul style="list-style-type: none"> <li>The accelerator pedal should move smoothly (without uneven pedal effort or catching).</li> </ul>
Automatic transmission "Park" mechanism	<ul style="list-style-type: none"> <li>When parked on a slope and the shift lever is in P, is the vehicle securely stopped?</li> </ul>
Brake pedal	<ul style="list-style-type: none"> <li>Does the brake pedal move smoothly?</li> <li>Does the brake pedal have appropriate clearance from the floor? (→P. 467)</li> <li>Does the brake pedal have the correct amount of free play? (→P. 467)</li> </ul>
Brakes	<ul style="list-style-type: none"> <li>The vehicle should not pull to one side when the brakes are applied.</li> <li>The brakes should work effectively.</li> <li>The brake pedal should not feel spongy.</li> <li>The brake pedal should not get too close to the floor when the brakes are applied.</li> </ul>
Head restraints	<ul style="list-style-type: none"> <li>Do the head restraints move smoothly and lock securely?</li> </ul>
Indicators/buzzers	<ul style="list-style-type: none"> <li>Do the indicators and buzzers function properly?</li> </ul>
Lights	<ul style="list-style-type: none"> <li>Do all the lights come on? تلفن شبانه ۰۲۱-۸۸۵۲۰۸۸</li> </ul>
Parking brake	<ul style="list-style-type: none"> <li>Does the parking brake pedal move smoothly?</li> <li>When parked on a slope and the parking brake is on, is the vehicle securely stopped?</li> </ul>
Seat belts	<ul style="list-style-type: none"> <li>Do the seat belts operate smoothly?</li> <li>The seat belts should not be damaged.</li> </ul>
Seats	<ul style="list-style-type: none"> <li>Do the seat controls operate properly?</li> </ul>
Steering wheel	<ul style="list-style-type: none"> <li>Does the steering wheel rotate smoothly?</li> <li>Does the steering wheel have the correct amount of free play?</li> <li>There should not be any strange sounds coming from the steering wheel.</li> </ul>

**Vehicle exterior**

Items	Check points
Doors	<ul style="list-style-type: none"> <li>Do the doors operate smoothly?</li> </ul>
Engine hood	<ul style="list-style-type: none"> <li>Does the engine hood lock system work properly?</li> </ul>
Fluid leaks	<ul style="list-style-type: none"> <li>There should not be any signs of fluid leakage after the vehicle has been parked.</li> </ul>
Tires	<ul style="list-style-type: none"> <li>Is the tire inflation pressure correct?</li> <li>The tires should not be damaged or excessively worn.</li> <li>Have the tires been rotated according to the maintenance schedule?</li> <li>The wheel nuts should not be loose.</li> </ul>
Windshield wipers/ rear window wiper	<ul style="list-style-type: none"> <li>The wiper blades should not show any signs of cracking, splitting, wear, contamination or deformation.</li> <li>The wiper blades should clear the windshield/rear window without streaking or skipping.</li> </ul>

**⚠ CAUTION****■ If the engine is running**

Turn the engine off and ensure that there is adequate ventilation before performing maintenance checks.

## Emission inspection and maintenance (I/M) programs

**Some states have vehicle emission inspection programs which include OBD (On Board Diagnostics) checks. The OBD system monitors the operation of the emission control system.**

### **If the malfunction indicator lamp comes on**

The OBD system determines that a problem exists somewhere in the emission control system. Your vehicle may not pass the I/M test and may need to be repaired. Contact your Toyota dealer to service the vehicle.

### **Your vehicle may not pass the I/M test in the following situations:**

- When the battery is disconnected or discharged  
Readiness codes that are set during ordinary driving are erased. Also, depending on your driving habits, the readiness codes may not be completely set.
- When the fuel tank cap is loose  
The malfunction indicator lamp comes on, indicating a temporary malfunction and your vehicle may not pass the I/M test.

### **When the malfunction indicator lamp still remains on after several driving trips**

The error code in the OBD system will not be cleared unless the vehicle is driven 40 or more times.

### **If your vehicle does not pass the I/M test**

Contact your Toyota dealer to prepare the vehicle for re-testing.

## Do-it-yourself service precautions

**If you perform maintenance by yourself, be sure to follow the correct procedure as given in these sections.**

Items	Parts and tools
Battery condition (→P. 367)	<ul style="list-style-type: none"> <li>• Warm water</li> <li>• Grease</li> <li>• Conventional wrench (for terminal clamp bolts)</li> <li>• Baking soda</li> </ul>
Brake fluid level (→P. 364)	<ul style="list-style-type: none"> <li>• FMVSS No.116 DOT 3 or SAE J1703 brake fluid</li> <li>• Rag or paper towel</li> <li>• Funnel (used only for adding brake fluid)</li> </ul>
Engine coolant level (→P. 362)	<ul style="list-style-type: none"> <li>• “Toyota Super Long Life Coolant” or a similar high quality ethylene glycol-based non-silicate, non-amine, non-nitrite and non-borate coolant with long-life hybrid organic acid technology</li> <li>For the U.S.A.: “Toyota Super Long Life Coolant” is pre-mixed with 50% coolant and 50% deionized water.</li> <li>For Canada: “Toyota Super Long Life Coolant” is pre-mixed with 55% coolant and 45% deionized water.</li> <li>• Funnel (used only for adding coolant)</li> </ul>
Engine oil level (→P. 359)	<ul style="list-style-type: none"> <li>• “Toyota Genuine Motor Oil” or equivalent</li> <li>• Rag or paper towel</li> <li>• Funnel (used only for adding engine oil)</li> </ul>

Items	Parts and tools
Fuses (→P. 388)	<ul style="list-style-type: none"> <li>• Fuse with same amperage rating as original</li> </ul>
Light bulbs (→P. 391)	<ul style="list-style-type: none"> <li>• Bulb with same number and wattage rating as original</li> <li>• Phillips-head screwdriver</li> <li>• Flathead screwdriver</li> <li>• Wrench</li> </ul>
Power steering fluid level (→P. 366)	<ul style="list-style-type: none"> <li>• Automatic transmission fluid DEXRON® II or III</li> <li>• Rag or paper towel</li> <li>• Clean funnel</li> </ul>
Radiator and condenser (→P. 363)	—
Tire inflation pressure (→P. 377)	<ul style="list-style-type: none"> <li>• Tire pressure gauge</li> <li>• Compressed air source</li> </ul>
Washer fluid (→P. 370)	<ul style="list-style-type: none"> <li>• Water or washer fluid containing antifreeze (for winter use)</li> <li>• Funnel (used only for adding water or washer fluid)</li> </ul>

تلفن شبانه روزی: ۰۲۱-۸۸۸۶۲۰۸۵

FarmaSOS.com



 CAUTION

The engine compartment contains many mechanisms and fluids that may move suddenly, become hot, or become electrically energized. To avoid death or serious injury, observe the following precautions.

**■ When working on the engine compartment**

- Keep hands, clothing and tools away from the moving fan and engine drive belt.
- Be careful not to touch the engine, radiator, exhaust manifold, etc. right after driving as they may be hot. Oil and other fluids may also be hot.
- Do not leave anything that may burn easily, such as paper and rags, in the engine compartment.
- Do not smoke, cause sparks or expose an open flame to fuel or the battery. Fuel and battery fumes are flammable.
- Be extremely cautious when working on the battery. It contains poisonous and corrosive sulfuric acid.

**■ Safety glasses**

Wear safety glasses to prevent flying or falling material, fluid spray, etc. from getting in your eyes.

 NOTICE**■ If you remove the air cleaner filter**

Driving with the air cleaner filter removed may cause excessive engine wear due to dirt in the air.

FarmaSOS.com

## Hood

### Release the lock from the inside of the vehicle to open the hood.

- 1 Pull the hood lock release lever.  
The hood will pop up slightly.

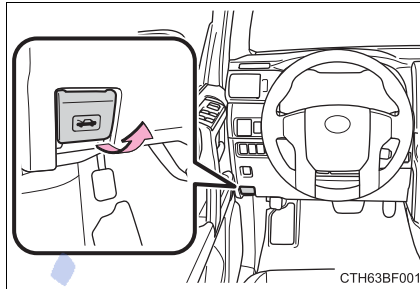

- 2 Push the auxiliary catch lever to the left and lift the hood.

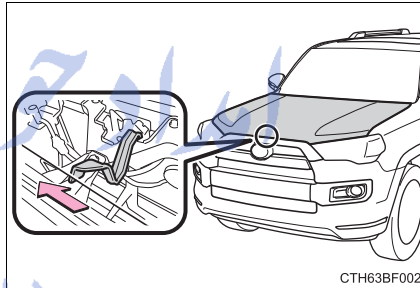

### ⚠ CAUTION

#### ■ Pre-driving check

Check that the hood is fully closed and locked.  
If the hood is not locked properly, it may open while the vehicle is in motion and cause an accident, which may result in death or serious injury.

## Engine compartment

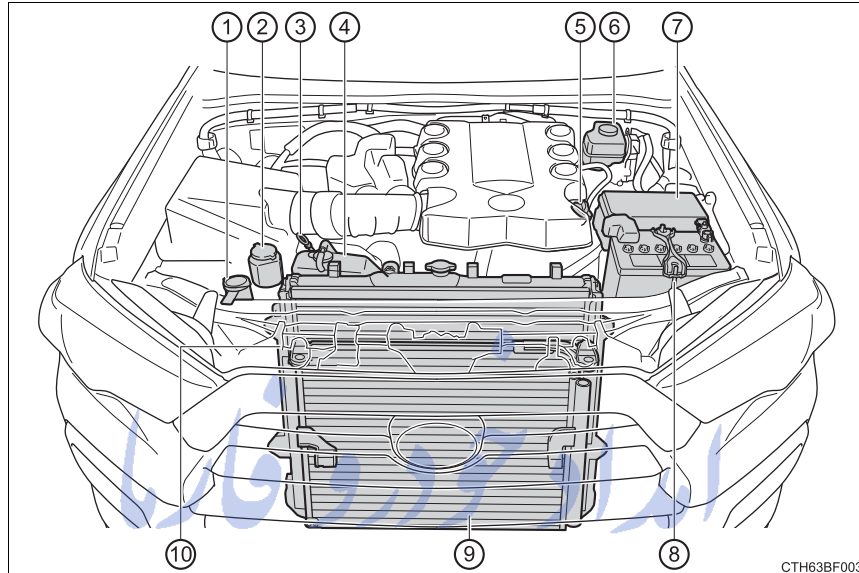

- |  |                                   |
|--|-----------------------------------|
| ① Washer fluid tank (→P. 370)              | ⑥ Brake fluid reservoir (→P. 364) |
| ② Power steering fluid reservoir (→P. 366) | ⑦ Fuse box (→P. 388)              |
| ③ Engine oil level dipstick (→P. 359)      | ⑧ Battery (→P. 367)               |
| ④ Engine coolant reservoir (→P. 362)       | ⑨ Condenser (→P. 363)             |
| ⑤ Engine oil filler cap (→P. 360)          | ⑩ Radiator (→P. 363)              |

## Engine compartment cover

### ■ Removing the engine compartment cover

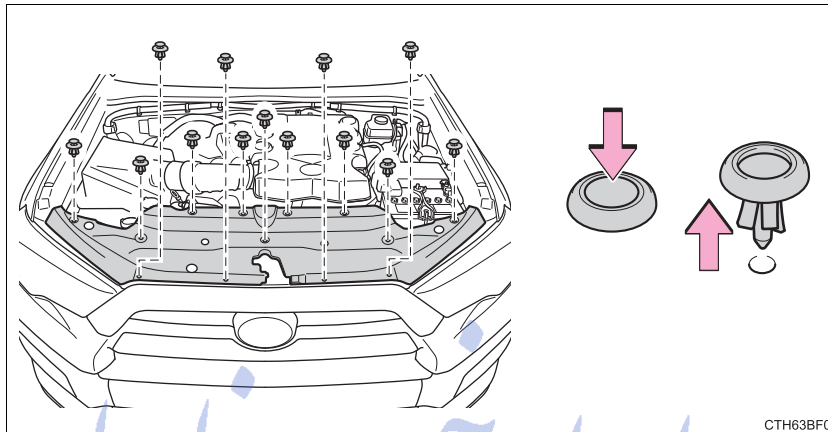

CTH63BF00

### ■ Installing the clips

- ① Push up center portion
- ② Insert
- ③ Press

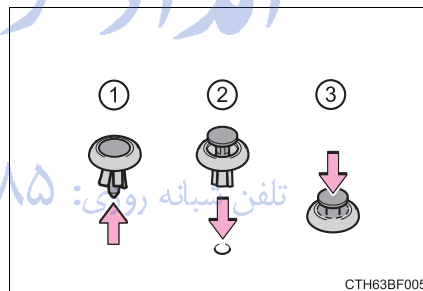

CTH63BF005

### ⚠ NOTICE

#### ■ After installing an engine compartment cover

Make sure that the cover is securely installed in its original position.

## Engine oil

With the engine at operating temperature and turned off, check the oil level on the dipstick.

### ■ Checking the engine oil

- 1 Park the vehicle on level ground. After warming up the engine and turning it off, wait more than 5 minutes for the oil to drain back into the bottom of the engine.
- 2 Holding a rag under the end, pull the dipstick out.

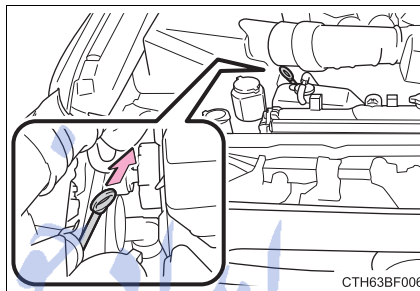

- 3 Wipe the dipstick clean.
- 4 Reinsert the dipstick fully.
- 5 Holding a rag under the end, pull the dipstick out and check the oil level.

- ① Low
- ② Normal
- ③ Excessive

The shape of the dipstick may differ depending on the type of vehicle or engine.

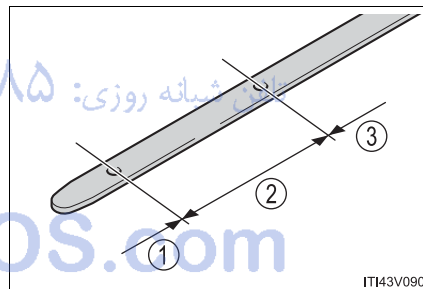

- 6 Wipe the dipstick and reinsert it fully.

### ■ Adding engine oil

If the oil level is below or near the low level mark, add engine oil of the same type as that already in the engine.

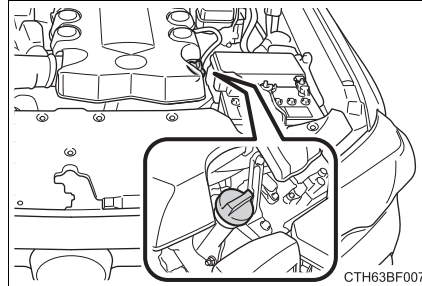

Make sure to check the oil type and prepare the items needed before adding oil.

Engine oil selection	→P. 463
Oil quantity (Low → Full)	1.8 qt. (1.7 L, 1.5 Imp. qt.)
Items	Clean funnel

- 1 Remove the oil filler cap by turning it counterclockwise.
- 2 Add engine oil slowly, checking the dipstick.
- 3 Install the oil filler cap by turning it clockwise.

### ■ Engine oil consumption

A certain amount of engine oil will be consumed while driving. In the following situations, oil consumption may increase, and engine oil may need to be refilled in between oil maintenance intervals.

- When the engine is new, for example directly after purchasing the vehicle or after replacing the engine
- If low quality oil or oil of an inappropriate viscosity is used
- When driving at high engine speeds or with a heavy load, when towing, or when driving while accelerating or decelerating frequently
- When leaving the engine idling for a long time, or when driving frequently through heavy traffic

 CAUTION■ **Used engine oil**

- Used engine oil contains potentially harmful contaminants which may cause skin disorders such as inflammation and skin cancer, so care should be taken to avoid prolonged and repeated contact. To remove used engine oil from your skin, wash thoroughly with soap and water.
- Dispose of used oil and filters only in a safe and acceptable manner. Do not dispose of used oil and filters in household trash, in sewers or onto the ground.  
Call your Toyota dealer, service station or auto parts store for information concerning recycling or disposal.
- Do not leave used engine oil within the reach of children.

 NOTICE■ **To prevent serious engine damage**

Check the oil level on a regular basis.

■ **When replacing the engine oil**

- Be careful not to spill engine oil on the vehicle components.
- Avoid overfilling, or the engine could be damaged.
- Check the oil level on the dipstick every time you refill the vehicle.
- Be sure the engine oil filler cap is properly tightened.

FarmaSOS.com

### Engine coolant

The coolant level is satisfactory if it is between the “F” and “L” lines on the reservoir when the engine is cold.

- ① Reservoir cap
- ② “F” line
- ③ “L” line

If the level is on or below the “L” line, add coolant up to the “F” line.  
(→P. 455)

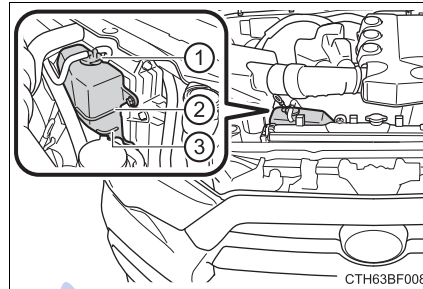

#### ■ Coolant selection

Only use “Toyota Super Long Life Coolant” or a similar high quality ethylene glycol based non-silicate, non-amine, non-nitrite, and non-borate coolant with long-life hybrid organic acid technology.

U.S.A.:

“Toyota Super Long Life Coolant” is a mixture of 50% coolant and 50% deionized water. (Minimum temperature: -31°F [-35°C])

Canada:

“Toyota Super Long Life Coolant” is a mixture of 55% coolant and 45% deionized water. (Minimum temperature: -44°F [-42°C])

For more details about engine coolant, contact your Toyota dealer.

#### ■ If the coolant level drops within a short time of replenishing

Visually check the radiator, hoses, engine coolant reservoir caps, drain cock and water pump.

If you cannot find a leak, have your Toyota dealer test the cap and check for leaks in the cooling system.



**⚠ CAUTION****■ When the engine is hot**

Do not remove the engine coolant reservoir cap or the radiator cap.  
(→P. 456)

The cooling system may be under pressure and may spray hot coolant if the cap is removed, causing serious injuries, such as burns.

**⚠ NOTICE****■ When adding coolant**

Coolant is neither plain water nor straight antifreeze. The correct mixture of water and antifreeze must be used to provide proper lubrication, corrosion protection and cooling. Be sure to read the antifreeze or coolant label.

**■ If you spill coolant**

Be sure to wash it off with water to prevent it from damaging parts or paint.

**Radiator and condenser**

Check the radiator and condenser and clear away any foreign objects. If either of the above parts is extremely dirty or you are not sure of their condition, have your vehicle inspected by your Toyota dealer.

**⚠ CAUTION****■ When the engine is hot**

Do not touch the radiator or condenser as they may be hot and cause serious injuries, such as burns.

## Brake fluid

### ■ Checking fluid level

The brake fluid level should be between the "MAX" and "MIN" lines on the tank.

- ① "MAX" line
- ② "MIN" line

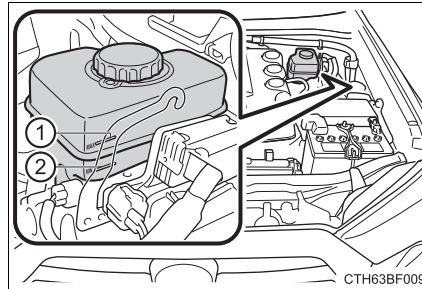

### ■ Adding fluid

Make sure to check the fluid type and prepare the necessary item.

Fluid type	FMVSS No.116 DOT 3 or SAE J1703 brake fluid
Items	Clean funnel

### ■ Refilling brake fluid

- ① Turn the engine switch off.
- ② Depress the brake pedal more than 40 times.
- ③ Remove the reservoir cap by hand. Add brake fluid up to the "MAX" line.

If you do not follow the procedure above, the reservoir may overflow.

FarmaSOS.com

**■ Brake fluid can absorb moisture from the air**

Excess moisture in the brake fluid can cause a dangerous loss of braking efficiency. Use only newly opened brake fluid.

**⚠ CAUTION****■ When filling the reservoir**

Take care as brake fluid can harm your hands and eyes and damage painted surfaces.

If fluid gets on your hands or in your eyes, flush the affected area with clean water immediately.

If you still experience discomfort, see a doctor.

**⚠ NOTICE****■ If the fluid level is low or high**

It is normal for the brake fluid level to go down slightly as the brake pads wear out or when the fluid level in the accumulator is high.

If the reservoir needs frequent refilling, there may be a serious problem.

تلفن شبانه روزی: ۰۲۱-۸۸۶۲۰۸۵

FarmaSOS.com

## Power steering fluid

### ■ Fluid level

The fluid level should be within the appropriate range.

- ① Full (when cold)
- ② Add fluid (when cold)
- ③ Full (when hot)
- ④ Add fluid (when hot)

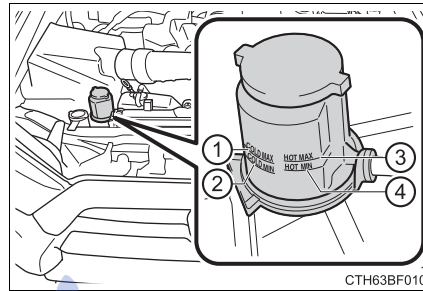

**Hot:** Vehicle has been driven around 50 mph (80 km/h) for 20 minutes, or slightly longer in frigid temperatures. (Fluid temperature, 140°F - 175°F [60°C - 80°C]).

**Cold:** Engine has not been run for about 5 hours. (Room temperature, 50°F - 85°F [10°C - 30°C]).

### ■ Checking the fluid level

Make sure to check the fluid type and prepare the necessary items.

Fluid type	Automatic transmission fluid DEXRON® II or III
Items	Rag or paper, clean funnel (only for adding fluid)

- ① Clean all dirt off the reservoir.
- ② Remove the cap by turning it counterclockwise.
- ③ Wipe the dipstick clean.
- ④ Reinstall the cap and remove it again.
- ⑤ Check the fluid level.

**⚠ CAUTION****■ When checking the reservoir**

Take care as the reservoir may be hot.

**⚠ NOTICE****■ When adding fluid**

Avoid overfilling, or the power steering may be damaged.

**■ After replacing the reservoir cap**

Check the steering box case, vane pump and hose connections for leaks or damage.

**Battery**

Check the battery as follows.

**■ Battery exterior**

Make sure that the battery terminals are not corroded and that there are no loose connections, cracks, or loose clamps.

- ① Terminals
- ② Hold-down clamp

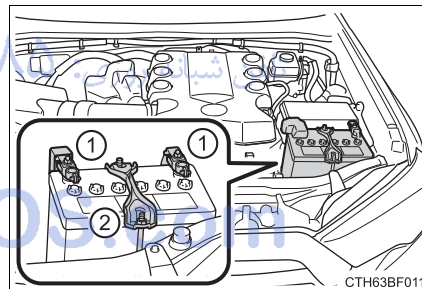
**■ Before recharging**

When recharging, the battery produces hydrogen gas which is flammable and explosive. Therefore, observe the following before recharging:

- If recharging with the battery installed on the vehicle, be sure to disconnect the ground cable.
- Make sure the power switch on the charger is off when connecting and disconnecting the charger cables to the battery.

**■ After recharging/reconnecting the battery (vehicles with a smart key system)**

The engine may not start. Follow the procedure below to initialize the system.

1 Shift the shift lever to P.

2 Open and close any of the doors.

3 Restart the engine.

- Unlocking the doors using the smart key system may not be possible immediately after reconnecting the battery. If this happens, use the wireless remote control or the mechanical key to lock/unlock the doors.
- Start the engine with the engine switch in ACCESSORY mode. The engine may not start when the engine switch turned from off. However, the engine will operate normally from the second attempt.
- The engine switch mode is recorded by the vehicle. If the battery is reconnected, the vehicle will return the engine switch mode to the status it was in before the battery was disconnected. Make sure to turn off the engine before disconnect the battery. Take extra care when connecting the battery if the engine switch mode prior to discharge is unknown.

If the system will not start even after multiple attempts, contact your Toyota dealer.

**⚠ CAUTION****■ Chemicals in the battery**

Batteries contain poisonous and corrosive sulfuric acid and may produce hydrogen gas which is flammable and explosive. To reduce the risk of death or serious injury, take the following precautions while working on or near the battery:

- Do not cause sparks by touching the battery terminals with tools.
- Do not smoke or light a match near the battery.
- Avoid contact with eyes, skin and clothes.
- Never inhale or swallow electrolyte.
- Wear protective safety glasses when working near the battery.
- Keep children away from the battery.

**⚠ CAUTION****■ Where to safely charge the battery**

Always charge the battery in an open area. Do not charge the battery in a garage or closed room where there is insufficient ventilation.

**■ How to recharge the battery**

Only perform a slow charge (5 A or less). The battery may explode if charged at a quicker rate.

**■ Emergency measures regarding electrolyte**

- If electrolyte gets in your eyes  
Flush your eyes with clean water for at least 15 minutes and get immediate medical attention. If possible, continue to apply water with a sponge or cloth while traveling to the nearest medical facility.
- If electrolyte gets on your skin  
Wash the affected area thoroughly. If you feel pain or burning, get medical attention immediately.
- If electrolyte gets on your clothes  
It can soak through clothing on to your skin. Immediately take off the clothing and follow the procedure above if necessary.
- If you accidentally swallow electrolyte  
Drink a large quantity of water or milk. Get emergency medical attention immediately.

**⚠ NOTICE****■ When recharging the battery**

Never recharge the battery while the engine is running. Also, be sure all accessories are turned off.

### Washer fluid

#### ► Type A

If any washer does not work or the low washer fluid warning light comes on, the washer tank may be empty. Add washer fluid.

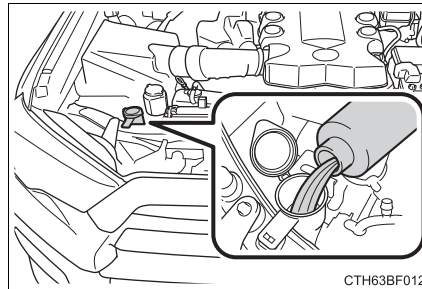

CTH63BF012

#### ► Type B

If the washer fluid level is at "LOW", add washer fluid.

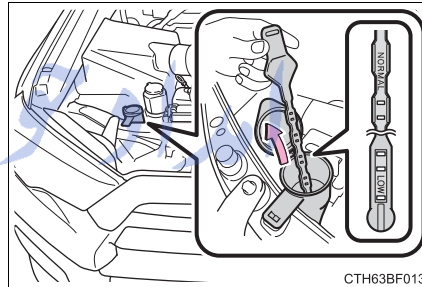

CTH63BF013

#### ■ Using the gauge (Type B only)

The washer fluid level can be checked by observing the position of the level on the liquid-covered holes in the gauge. If the level falls below the second hole from the bottom (the "LOW" position), refill the washer fluid.

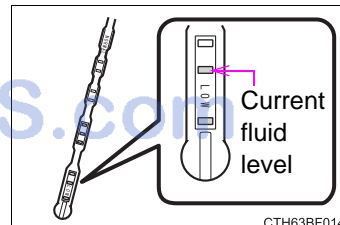

CTH63BF014



 CAUTION■ **When adding washer fluid**

Do not add washer fluid when the engine is hot or running as washer fluid contains alcohol and may catch fire if spilled on the engine etc.

 NOTICE■ **Do not use any fluid other than washer fluid**

Do not use soapy water or engine antifreeze instead of washer fluid. Doing so may cause streaking on the vehicle's painted surfaces.

■ **Diluting washer fluid**

Dilute washer fluid with water as necessary.  
Refer to the freezing temperatures listed on the label of the washer fluid bottle.

امداد خودرو فارما

تلفن شبانه روزی: ۰۲۱-۸۸۸۶۲۰۸۵

FarmaSOS.com

## Tires

Replace or rotate tires in accordance with maintenance schedules and treadwear.

### Checking tires

- ① New tread
- ② Treadwear indicator
- ③ Worn tread

The location of treadwear indicators is shown by the "TWI" or "Δ" marks, etc., molded on the sidewall of each tire.

Check spare tire condition and pressure if not rotated.

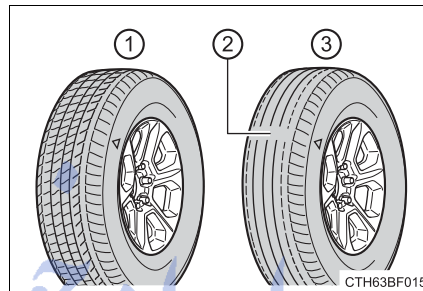

### Tire rotation

Rotate the tires in the order shown.

To equalize tire wear and extend tire life, Toyota recommends that tire rotation is carried out at the same interval as tire inspection.

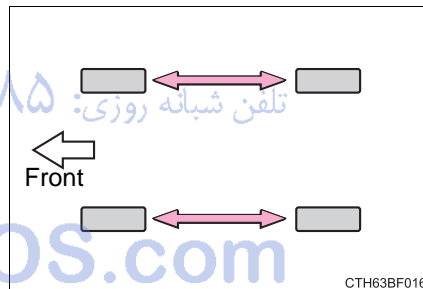

### Tire pressure warning system

Your vehicle is equipped with a tire pressure warning system that uses tire pressure warning valves and transmitters to detect low tire inflation pressure before serious problems arise. (→P. 421)

#### ◆ Installing tire pressure warning valves and transmitters

When replacing tires or wheels, tire pressure warning valves and transmitters must also be installed.

When new tire pressure warning valves and transmitters are installed, new ID codes must be registered in the tire pressure warning computer and the tire pressure warning system must be initialized. Have tire pressure warning valve and transmitter ID codes registered by your Toyota dealer. (→P. 373)

#### ◆ Registering ID codes

The tire pressure warning valve and transmitter is equipped with a unique ID code. When replacing a tire pressure warning valve and transmitter, it is necessary to register the ID code. Have the ID code registered by your Toyota dealer.

#### ■ When to replace your vehicle's tires

Tires should be replaced if:

- You have tire damage such as cuts, splits, cracks deep enough to expose the fabric, and bulges indicating internal damage
- A tire goes flat repeatedly or cannot be properly repaired due to the size or location of a cut or other damage

If you are not sure, consult with your Toyota dealer.

#### ■ Replacing tires and wheels

If the ID code of the tire pressure warning valve and transmitter is not registered, the tire pressure warning system will not work properly. After driving for about 20 minutes, the tire pressure warning light blinks for 1 minute and stays on to indicate a system malfunction.

#### ■ Tire life

Any tire over 6 years old must be checked by a qualified technician even if it has seldom or never been used or damage is not obvious.

### ■ Routine tire inflation pressure checks

The tire pressure warning system does not replace routine tire inflation pressure checks. Make sure to check tire inflation pressure as part of your routine of daily vehicle checks.

### ■ Maximum load of tire

Check that the number given by dividing the maximum load by 1.10 of the replacement tire is greater than 1/2 of the Gross Axle Weight Ratings (GAWR) of either the front axle or the rear axle, whichever is greater.

For the GAWR, see the Certification Label. For the maximum load of the tire, see the load limit at maximum cold tire inflation pressure mentioned on the sidewall of the tire. (→P. 473)

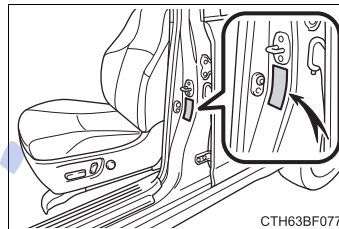

### ■ Tire types

#### ● Summer tires

Summer tires are high-speed performance tires best suited to highway driving under dry conditions. Since summer tires do not have the same traction performance as snow tires, summer tires are inadequate for driving on snow-covered or icy roads. For driving on snow-covered roads or icy roads, the use of snow tires is recommended. When installing snow tires, be sure to replace all four tires. تلفن شبانه رونق

#### ● All season tires

All season tires are designed to provide better traction in snow and to be adequate for driving in most winter conditions as well as for use year-round. All season tires, however, do not have adequate traction performance compared with snow tires in heavy or loose snow. Also, all season tires fall short in acceleration and handling performance compared with summer tires in highway driving.

#### ● Snow tires

For driving on snow-covered roads or icy roads, we recommend using snow tires. If you need snow tires, select tires of the same size, construction and load capacity as the originally installed tires. Since your vehicle has radial tires as original equipment, make sure your snow tires also have radial construction. Do not install studded tires without first checking local regulations for possible restrictions. Snow tires should be installed on all wheels. (→P. 269)

■ **If the tread on snow tires wears down below 0.16 in. (4 mm)**

The effectiveness of the tires as snow tires is lost.

■ **Tire pressure warning system certification**

FCC ID: PAXPMV107J

FCC ID: HYQ13BCX

► For vehicles sold in the U.S.A.

This device complies with Part 15 of the FCC Rules. Operation is subject to the following two conditions: (1) this device may not cause harmful interference, and (2) this device must accept any interference received, including interference that may cause undesired operation.

FCC WARNING:

Changes or modifications not expressly approved by the party responsible for compliance could void the user's authority to operate the equipment.

► For vehicles sold in Canada

Operation is subject to the following two conditions: (1) this device may not cause interference, and (2) this device must accept any interference, including interference that may cause undesired operation of the device.

 **CAUTION**

■ **When inspecting or replacing tires**

Observe the following precautions to prevent accidents.

Failure to do so may cause damage to parts of the drive train as well as dangerous handling characteristics, which may lead to an accident resulting in death or serious injury.

- Do not mix tires of different makes, models or tread patterns.  
Also, do not mix tires of remarkably different treadwear.
- Do not use tire sizes other than those recommended by Toyota.
- Do not mix differently constructed tires (radial, bias-belted or bias-ply tires).
- Do not mix summer, all season and snow tires.
- Do not use tires that have been used on another vehicle.  
Do not use tires if you do not know how they were used previously.

 NOTICE**■ Repairing or replacing tires, wheels, tire pressure warning valves, transmitters and tire valve caps**

- When removing or fitting the wheels, tires or the tire pressure warning valves and transmitters, contact your Toyota dealer as the tire pressure warning valves and transmitters may be damaged if not handled correctly.
- When replacing tire valve caps, do not use tire valve caps other than those specified. The cap may become stuck.

**■ To avoid damage to the tire pressure warning valves and transmitters**

When a tire is repaired with liquid sealants, the tire pressure warning valve and transmitter may not operate properly. If a liquid sealant is used, contact your Toyota dealer or other qualified service shop as soon as possible. Make sure to replace the tire pressure warning valve and transmitter when replacing the tire. (→P. 373)

**■ Driving on rough roads**

Take particular care when driving on roads with loose surfaces or potholes.

These conditions may cause losses in tire inflation pressure, reducing the cushioning ability of the tires. In addition, driving on rough roads may cause damage to the tires themselves, as well as the vehicle's wheels and body.

**■ If tire inflation pressure of each tire becomes low while driving**

Do not continue driving, or your tires and/or wheels may be ruined.

FarmaSOS.com

## Tire inflation pressure

### Tire inflation pressure

The recommended cold tire inflation pressure and tire size are displayed on the tire and loading information label. (→P. 473)

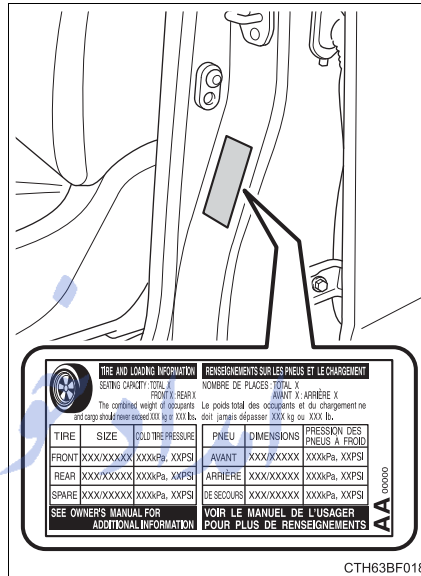

CTH63BF018

تلفن شبانه روزی: ۰۲۱-۸۸۸۶۲۰۸۵

FarmaSOS.com

6

Maintenance and care

### Inspection and adjustment procedure

- ① Tire valve
- ② Tire pressure gauge

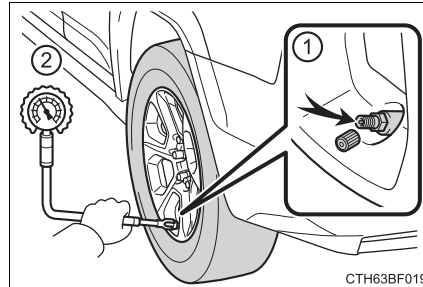

- 1 Remove the tire valve cap.
- 2 Press the tip of the tire pressure gauge onto the tire valve.
- 3 Read the pressure using the gauge gradations.
- 4 If the tire inflation pressure is not at the recommended level, adjust the pressure.  
If you add too much air, press the center of the valve to deflate.
- 5 After completing the tire inflation pressure measurement and adjustment, apply soapy water to the valve and check for leakage.
- 6 Put the tire valve cap back on.

#### ■ Tire inflation pressure check interval

You should check tire inflation pressure every two weeks, or at least once a month.

Do not forget to check the spare.

#### ■ Effects of incorrect tire inflation pressure

Driving with incorrect tire inflation pressure may result in the following:

- Reduced fuel efficiency
- Reduced driving comfort and tire life
- Reduced safety
- Damage to the drive train

If a tire needs frequent inflating, have it checked by your Toyota dealer.



### ■ Instructions for checking tire inflation pressure

When checking tire inflation pressure, observe the following:

- Check only when the tires are cold.  
If your vehicle has been parked for at least 3 hours or has not been driven for more than 1 mile or 1.5 km, you will get an accurate cold tire inflation pressure reading.
- Always use a tire pressure gauge.  
The appearance of the tire can be misleading. In addition, tire inflation pressure that is even just a few pounds off can affect ride quality and handling.
- Do not reduce tire inflation pressure after driving. It is normal for tire inflation pressure to be higher after driving.
- Never exceed the vehicle capacity weight.  
Passengers and luggage weight should be placed so that the vehicle is balanced.

#### CAUTION

##### ■ Proper inflation is critical to save tire performance

Keep your tires properly inflated. Otherwise, the following conditions may occur and result in an accident causing death or serious injury:

- Excessive wear
- Uneven wear
- Poor handling
- Possibility of blowouts resulting from overheated tires
- Poor sealing of the tire bead
- Wheel deformation and/or tire separation
- A greater possibility of tire damage from road hazards

#### NOTICE

##### ■ When inspecting and adjusting tire inflation pressure

Be sure to put the tire valve caps back on.  
Without the valve caps, dirt or moisture could get into the valve and cause air leakage, which could result in an accident. If the caps are lost, replace them as soon as possible.

## Wheels

**If a wheel is bent, cracked or heavily corroded, it should be replaced. Otherwise, the tire may separate from the wheel or cause a loss of handling control.**

### Wheel selection

When replacing wheels, care should be taken to ensure that they are equivalent to those removed in load capacity, diameter, rim width and inset\*.

Replacement wheels are available at your Toyota dealer.

\*: Conventionally referred to as "offset".

Toyota does not recommend using the following:

- Wheels of different sizes or types
- Used wheels
- Bent wheels that have been straightened

### Aluminum wheel precautions

- Use only Toyota wheel nuts and wrenches designed for use with your aluminum wheels.
- When rotating, repairing or changing your tires, check that the wheel nuts are still tight after driving 1000 miles (1600 km).
- Be careful not to damage the aluminum wheels when using tire chains.
- Use only Toyota genuine balance weights or equivalent and a plastic or rubber hammer when balancing your wheels.

### ■ When replacing wheels

The wheels of your vehicle are equipped with tire pressure warning valves and transmitters that allow the tire pressure warning system to provide advance warning in the event of a loss in tire inflation pressure. Whenever wheels are replaced, tire pressure warning valves and transmitters must be installed. (→P. 373)

#### ⚠ CAUTION

#### ■ When replacing wheels

- Do not use wheels that are a different size from those recommended in the Owner's Manual, as this may result in a loss of handling control.
- Never use an inner tube in a leaking wheel which is designed for a tubeless tire. Doing so may result in an accident, causing death or serious injury.

#### ■ When installing the wheel nuts

- Be sure to install the wheel nuts with the tapered ends facing inward. Installing the nuts with the tapered ends facing outward can cause the wheel to break and eventually cause the wheel to come off while driving, which could lead to an accident resulting in death or serious injury.

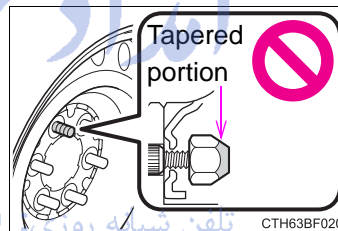

- Never use oil or grease on the wheel bolts or wheel nuts. Oil and grease may cause the wheel nuts to be excessively tightened, leading to bolt or disc wheel damage. In addition, the oil or grease can cause the wheel nuts to loosen and the wheel may fall off, causing an accident and resulting in death or serious injury. Remove any oil or grease from the wheel bolts or wheel nuts.

 NOTICE**■ Replacing tire pressure warning valves and transmitters**

- Because tire repair or replacement may affect the tire pressure warning valves and transmitters, make sure to have tires serviced by your Toyota dealer or other qualified service shop. In addition, make sure to purchase your tire pressure warning valves and transmitters at your Toyota dealer.
- Ensure that only genuine Toyota wheels are used on your vehicle. Tire pressure warning valves and transmitters may not work properly with non-genuine wheels.

امداد خودرو فارما

تلفن شبانه روزی: ۰۲۱-۸۸۸۶۲۰۸۵

FarmaSOS.com

## Air conditioning filter

The air conditioning filter must be changed regularly to maintain air conditioning efficiency.

### Removal method

- 1 Turn the engine switch off.
- 2 Open the glove box and remove the cover.

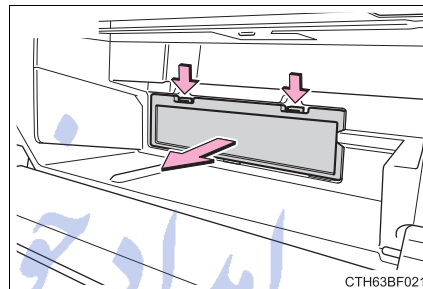

- 3 Remove the filter cover.

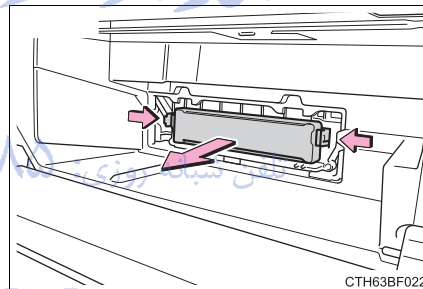

- 4 Remove the air conditioning filter and replace it with a new one.

The "↑UP" marks shown on the filter should be pointing up.

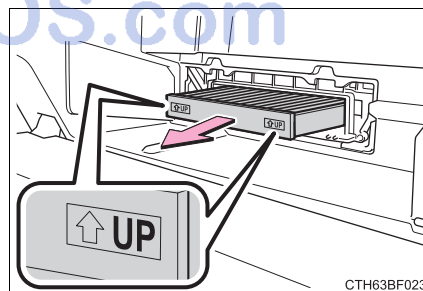

**■ Checking interval**

Inspect and replace the air conditioning filter according to the maintenance schedule. In dusty areas or areas with heavy traffic flow, early replacement may be required. (For scheduled maintenance information, please refer to the “Schedule maintenance guide” or “Owner’s Manual Supplement”.)

**■ If air flow from the vents decreases dramatically**

The filter may be clogged. Check the filter and replace if necessary.

**NOTICE****■ When using the air conditioning system**

Make sure that a filter is always installed.  
Using the air conditioning system without a filter may cause damage to the system.

امداد خودرو فارما

تلفن شبانه روزی: ۰۲۱-۸۸۸۶۲۰۸۵

FarmaSOS.com

## Wireless remote control/electronic key battery

Replace the battery with a new one if it is depleted.

### You will need the following items:

- Flathead screwdriver
- Small flathead screwdriver
- Lithium battery CR2016 (vehicles without a smart key system), or CR1632 (vehicles with a smart key system)

### Replacing the battery (vehicles without a smart key system)

- 1 Remove the cover.

To prevent damage to the key, cover the tip of the screwdriver with a rag.

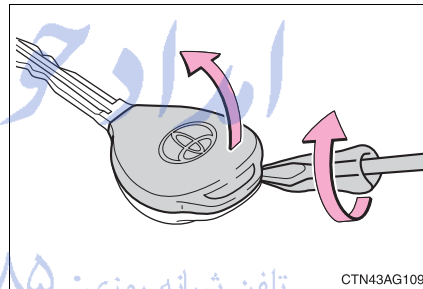

- 2 Remove the module.

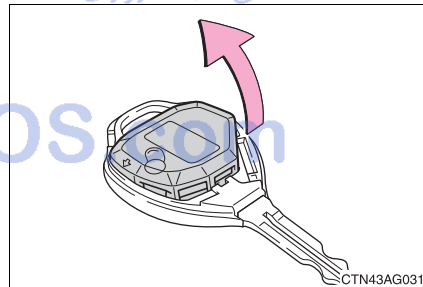

- 3 Open the case cover using a coin protected with tape etc. and remove the depleted battery.

Insert a new battery with the "+" terminal facing up.

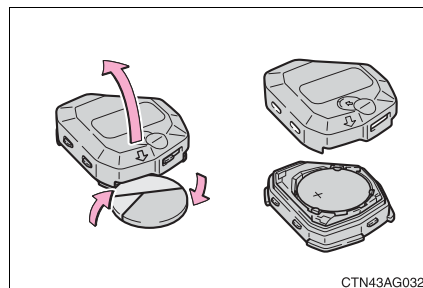

**Replacing the battery (vehicles with a smart key system)**

- 1 Take out the mechanical key.

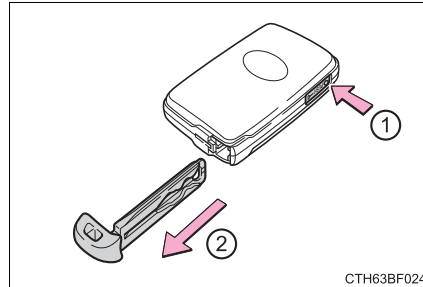

- 2 Remove the cover.

To prevent damage to the key, cover the tip of the screwdriver with a rag.

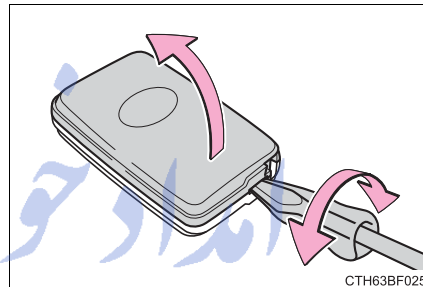

- 3 Remove the depleted battery.

Insert a new battery with the "+" terminal facing up.

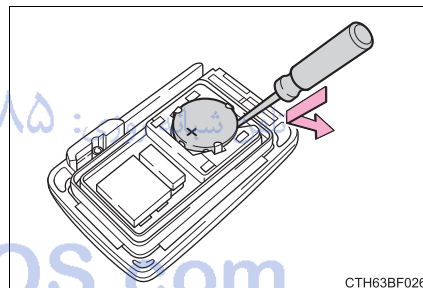



■ **Use a CR2016 (vehicles without a smart key system) or CR1632 (vehicles with a smart key system) lithium battery**

- Batteries can be purchased at your Toyota dealer, local electrical appliance shops or camera stores.
- Replace only with the same or equivalent type recommended by the manufacturer.
- Dispose of used batteries according to local laws.

■ **If the electronic key battery is depleted**

The following symptoms may occur:

- The smart key system and wireless remote control will not function properly.
- The operational range will be reduced.

 **CAUTION**

■ **Removed battery and other parts**

These parts are small and if swallowed by a child, they can cause choking. Keep away from children. Failure to do so could result in death or serious injury.

 **NOTICE**

■ **For normal operation after replacing the battery**

Observe the following precautions to prevent accidents:

- Always work with dry hands.  
Moisture may cause the battery to rust.
- Do not touch or move any other component inside the remote control.
- Do not bend either of the battery terminals.

## Checking and replacing fuses

**If any of the electrical components do not operate, a fuse may have blown. If this happens, check and replace the fuses as necessary.**

- 1 Turn the engine switch off.
- 2 Open the Fuse box cover.

► Engine compartment

Push the tab in and lift the lid off.

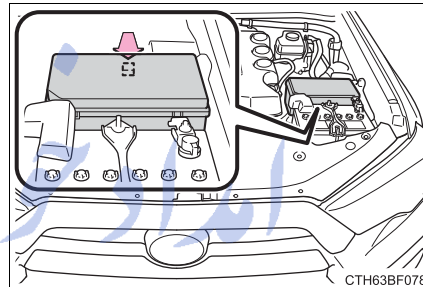

► Driver's side instrument panel

Remove the lid.

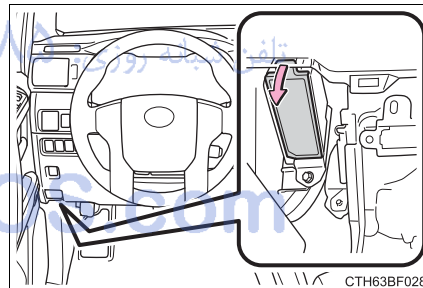

- 3 Remove the fuse with the pull-out tool.

Only type A fuse can be removed using the pullout tool.



4 Check if the fuse is blown.

- ① Normal fuse
- ② Blown fuse

Type A, B, C, D, E:

Replace the blown fuse with a new fuse of an appropriate amperage rating. The amperage rating can be found on the fuse box lid.

Type F:

Contact your Toyota dealer.

► Type A

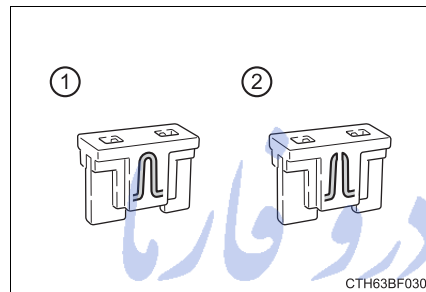

► Type B

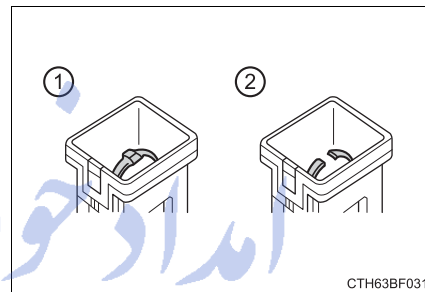

► Type C

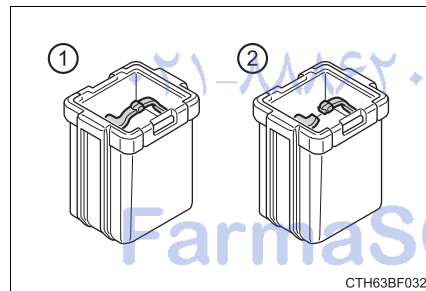

► Type D

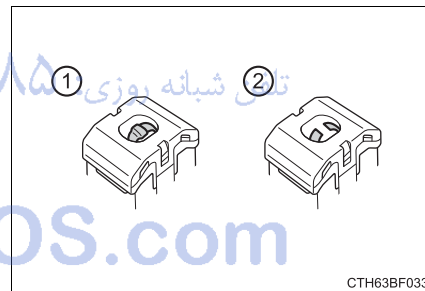

► Type E

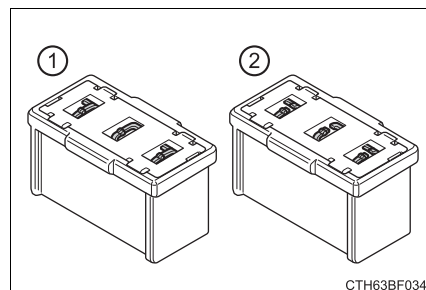

► Type F

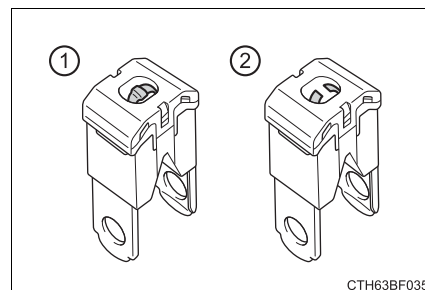

**■ After a fuse is replaced**

- If the lights do not turn on even after the fuse has been replaced, a bulb may need replacement. (→P. 391)
- If the replaced fuse blows again, have the vehicle inspected by your Toyota dealer.

**■ If there is an overload in a circuit**

The fuses are designed to blow, protecting the wiring harness from damage.

**⚠ CAUTION****■ To prevent system breakdowns and vehicle fire**

Observe the following precautions.

Failure to do so may cause damage to the vehicle, and possibly a fire or injury.

- Never use a fuse of a higher amperage rating than that indicated, or use any other object in place of a fuse.
- Always use a genuine Toyota fuse or equivalent.  
Never replace a fuse with a wire, even as a temporary fix.
- Do not modify the fuses or fuse boxes.

**⚠ NOTICE****■ Before replacing fuses**

Have the cause of electrical overload determined and repaired by your Toyota dealer as soon as possible.

FarmaSOS.com

## Light bulbs

**You may replace the following bulbs by yourself. The difficulty level of replacement varies depending on the bulb. If necessary bulb replacement seems difficult to perform, contact your Toyota dealer.**

**For more information about replacing other light bulbs, contact your Toyota dealer.**

### Preparing for light bulb replacement

Check the wattage of the light bulb to be replaced. (→P. 469)

امداد خودرو فارما

تلفن شبانه روزی: ۰۲۱-۸۸۸۶۲۰۸۵

FarmaSOS.com

### Bulb locations

#### ■ Front

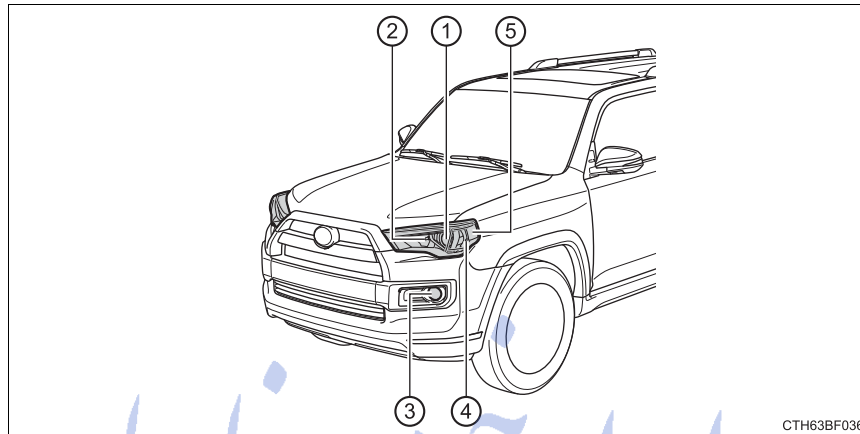

- ① Headlight low beam
- ② Headlight high beam/day-time running light
- ③ Fog light
- ④ Front turn signal/parking light
- ⑤ Front side marker light

#### ■ Rear

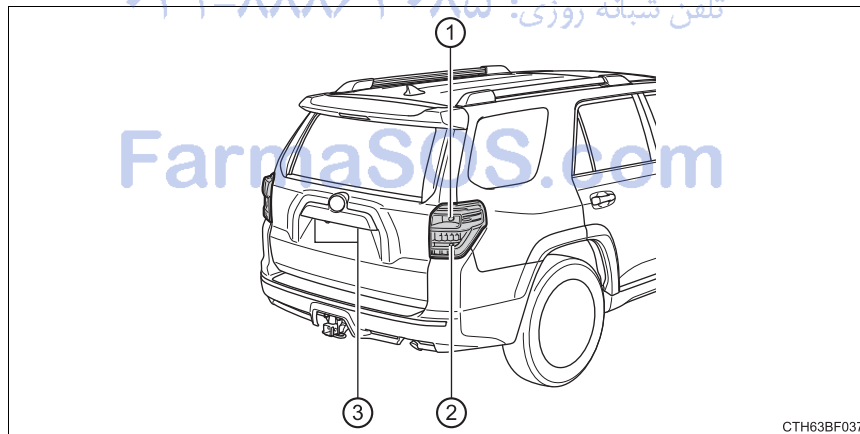

- ① Rear turn signal light
- ② Back-up light
- ③ License plate light

**Replacing light bulbs****■ Headlight low beams**

- 1 Turn the cover counterclockwise and remove it.

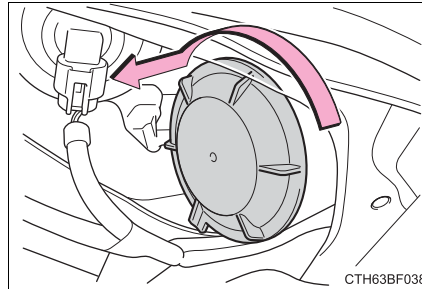

- 2 Turn the bulb base counterclockwise.

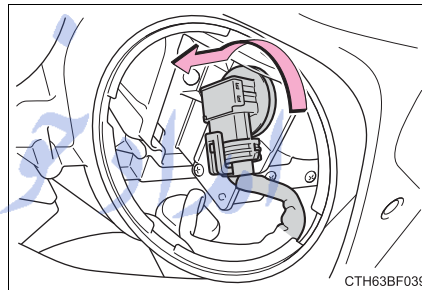

- 3 Unplug the connector while pulling the lock release.

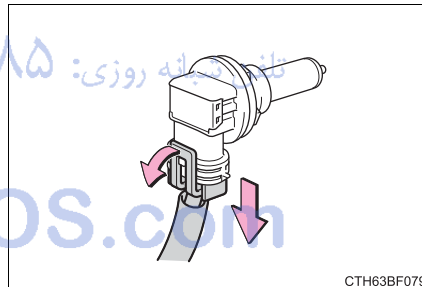

- 4 Replace the light bulb, and install the bulb base.

Align the 3 tabs on the light bulb with the mounting and insert.

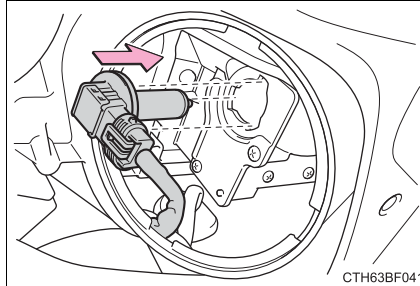

- 5 Turn and secure the bulb base.

Shake the bulb base gently to check that it is not loose, turn the headlights on once and visually confirm that no light is leaking through the mounting.

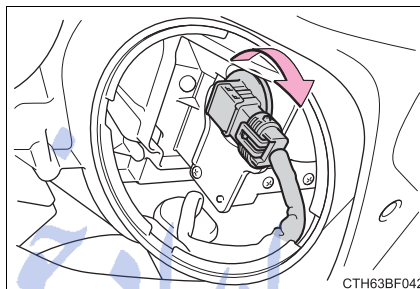

- 6 Install the cover.

تلفن شبانه روزی: ۰۲۱-۸۸۸۶۲۰۸۵

FarmaSOS.com



### ■ Headlight high beam/daytime running lights

- 1 Turn the bulb base counter-clockwise.

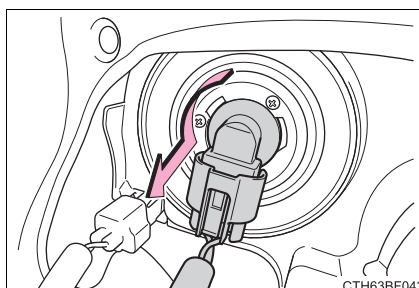

- 2 Pull the bulb out while pressing the lock release of the connector.

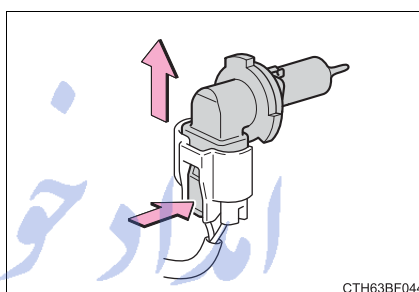

- 3 Replace the light bulb, and install the bulb base.

Align the 3 tabs on the light bulb with the mounting and insert.

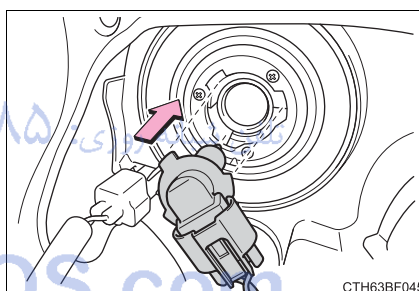

- 4 Turn and secure the bulb base.

Shake the bulb base gently to check that it is not loose, turn the headlights on once and visually confirm that no light is leaking through the mounting.

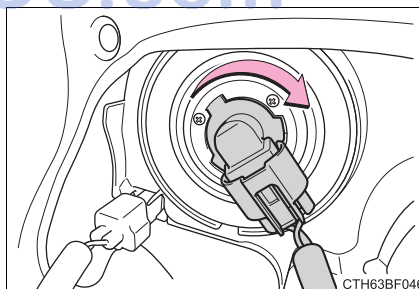

**■ Front turn signal/parking light**

- 1 Turn the steering wheel in the opposite direction of the front turn signal light and parking light that you wish to replace.

For example, if you wish to replace the front turn signal light and parking light on the right side, turn the steering wheel to the left.

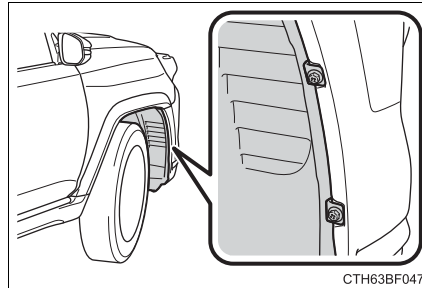

- 2 Remove the fender liner screws.

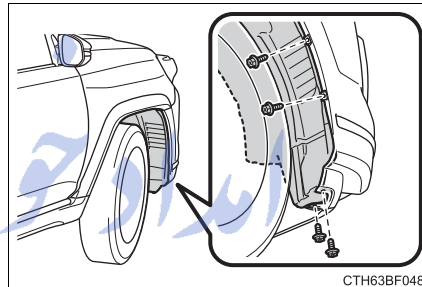

- 3 Partly remove the fender liner.

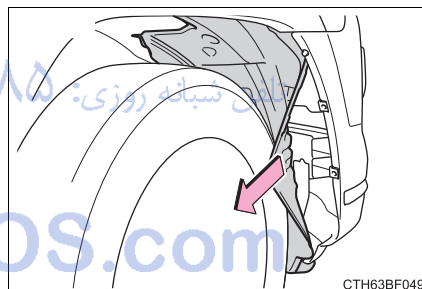

- 4 Turn the bulb base counter-clockwise.

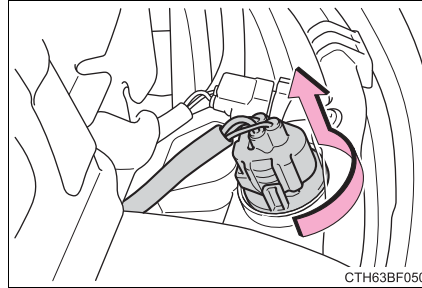

- 5 Remove the light bulb.

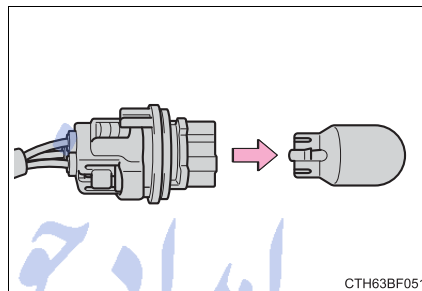

- 6 When installing, reverse the steps listed.

تلفن شبانه روزی: ۰۲۱-۸۸۸۶۲۰۸۵

FarmaSOS.com

**■ Front side marker lights**

- 1 Turn the steering wheel in the opposite direction of the front side marker light that you wish to replace.

For example, if you wish to replace the front side marker light on the right side, turn the steering wheel to the left.

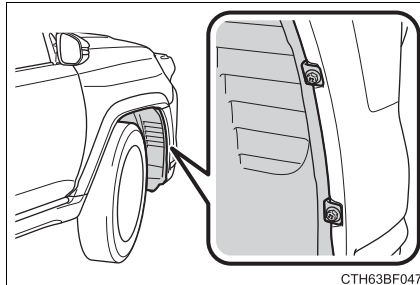

- 2 Remove the fender liner screws.

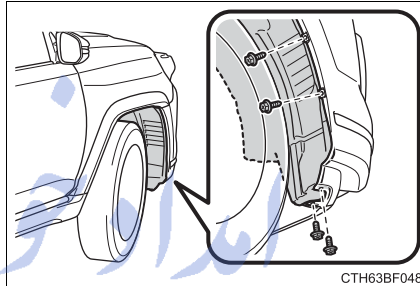

- 3 Partly remove the fender liner.

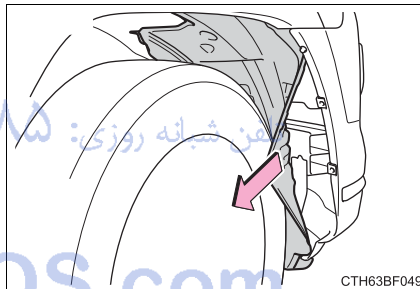

- 4 Turn the bulb base counter-clockwise.

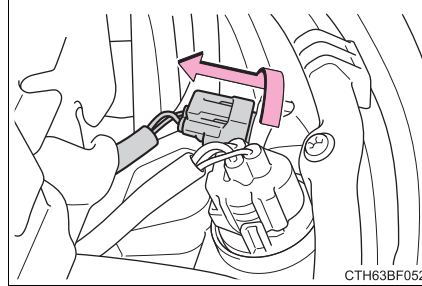

- 5 Remove the light bulb.

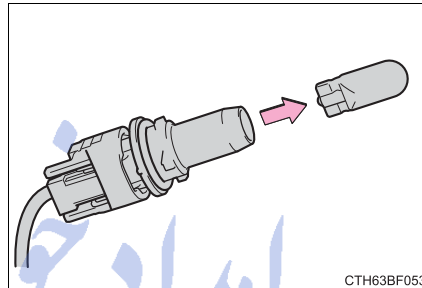

- 6 When installing, reverse the steps listed.

تلفن شبانه روزی: ۰۲۱-۸۸۸۶۲۰۸۵

FarmaSOS.com

**■ Fog light (left side)**

- 1 Turn the steering wheel in the opposite direction of the fog light that you wish to replace.

For example, if you wish to replace the fog light on the left side, turn the steering wheel to the right.

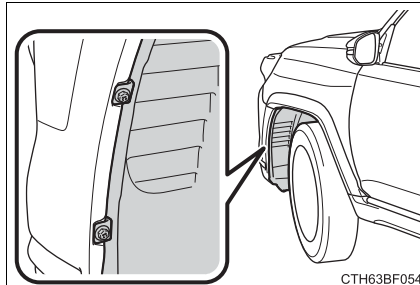

- 2 Remove the fender liner screws.

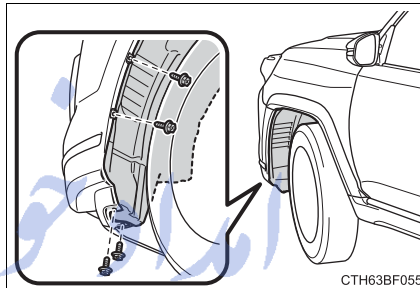

- 3 Partly remove the fender liner.

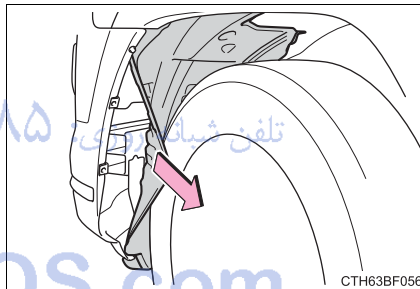

- 4 Unplug the connector while depressing the lock release.

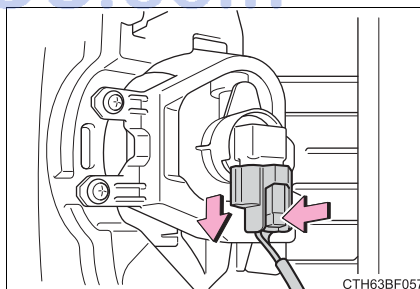

- 5 Turn the bulb base counter-clockwise.

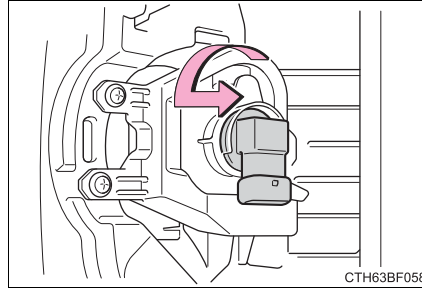

- 6 Install a new light bulb.  
Align the 3 tabs on the light bulb with the mounting and insert.

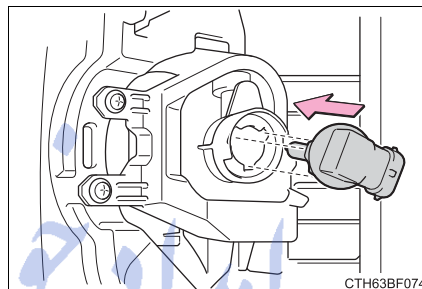

- 7 Turn clockwise and secure the bulb base.

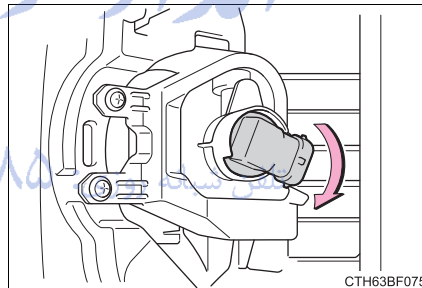

- 8 Install the connector.  
Shake the connector gently to check that it is not loose, turn the front fog lights on once and visually confirm that no light is leaking through the mounting.

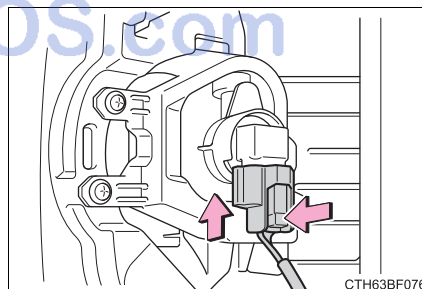

- 9 When installing the fender liner, install by conducting and with the directions reversed.

**■ Rear turn signal lights**

- 1 Open the back door and remove the cover.

To prevent damage to the vehicle, cover the tip of the screwdriver with a rag.

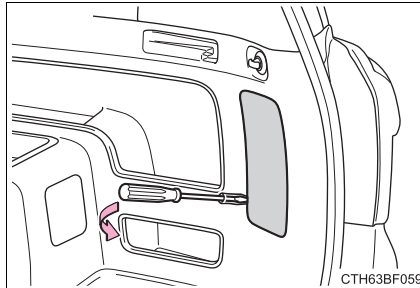

- 2 Turn the bulb base counter-clockwise.

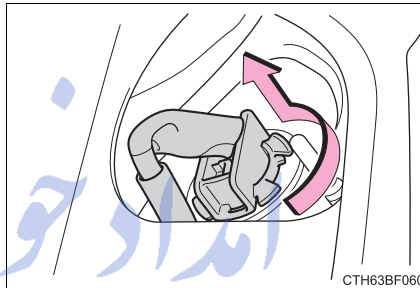

- 3 Remove the light bulb.

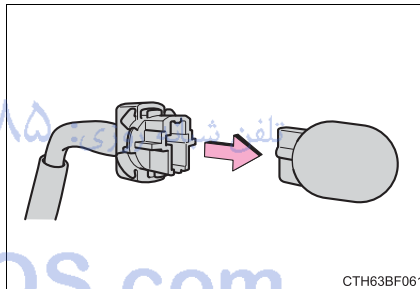

- 4 When installing, reverse the steps listed.



### ■ Back-up lights

- 1 Open the back door and remove the cover.

To prevent damage to the vehicle, cover the tip of the screwdriver with a rag.

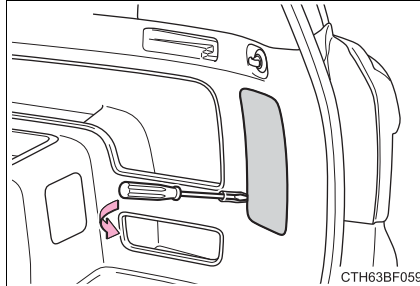

- 2 Turn the bulb base counter-clockwise.

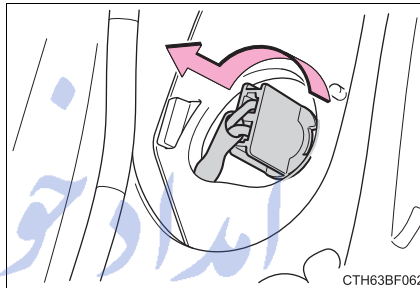

- 3 Remove the light bulb.

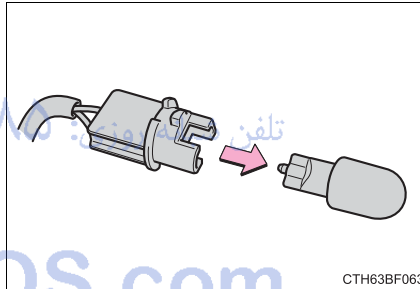

- 4 When installing, reverse the steps listed.

■ License plate lights

- 1 Remove the screws and lens.

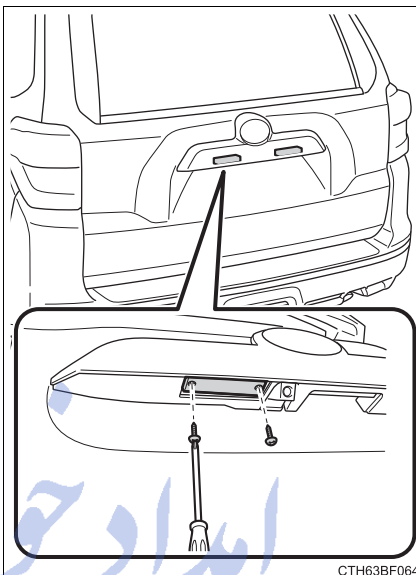

- 2 Remove the light bulb.

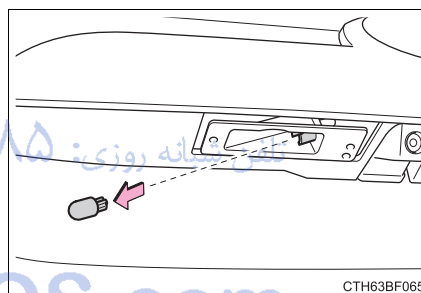

- 3 When installing, reverse the steps listed.

### ■ Replacing the following bulbs

If any of the lights listed below has burnt out, have it replaced by your Toyota dealer.

- Fog light (right side)
- Side turn signal lights
- Stop/tail lights
- Rear side marker lights
- High mounted stoplight
- Outer foot lights (if equipped)

### ■ LED light bulbs

The side turn signal lights, stop/tail lights, rear side marker lights, high mounted stoplight and outer foot lights consist of a number of LEDs. If any LEDs burn out, take your vehicle to your Toyota dealer to have the light replaced.

### ■ Condensation build-up on the inside of the lens

Temporary condensation build-up on the inside of the lens does not indicate a malfunction. Contact your Toyota dealer for more information in the following situations:

- Large drops of water have built up on the inside of the lens.
- Water has built up inside the lens.



CAUTION

### ■ Replacing light bulbs

- Turn off the lights. Do not attempt to replace the bulb immediately after turning off the lights.

The bulbs become very hot and may cause burns.

- Do not touch the glass portion of the light bulb with bare hands. When it is unavoidable to hold the glass portion, use and hold with a clean dry cloth to avoid getting moisture and oils on the bulb.

Also, if the bulb is scratched or dropped, it may blow out or crack.

- Fully install light bulbs and any parts used to secure them. Failure to do so may result in heat damage, fire, or water entering the headlight unit. This may damage the headlights or cause condensation to build up on the lens.

### ■ To prevent damage or fire

- Make sure bulbs are fully seated and locked.
- Check the wattage of the bulb before installing to prevent heat damage.

امداد خودرو فارما

تلفن شبانه روزی: ۰۲۱-۸۸۸۶۲۰۸۵

**FarmaSOS.com**

## When trouble arises

## 7

**7-1. Essential information**

- Emergency flashers ..... 408
- If your vehicle has to be stopped in an emergency ..... 409

**7-2. Steps to take in an emergency**

- If your vehicle needs to be towed ..... 411
- If you think something is wrong ..... 416
- Fuel pump shut off system ..... 417
- If a warning light turns on or a warning buzzer sounds ..... 418
- If a warning message or indicator is displayed ..... 426
- If you have a flat tire ..... 433
- If the engine will not start ..... 446
- If the shift lever cannot be shifted from P ..... 448
- If you cannot operate back door opener ..... 449
- If the electronic key does not operate properly ..... 450
- If the vehicle battery is discharged ..... 452
- If your vehicle overheats ... 455
- If the vehicle becomes stuck ..... 458

## Emergency flashers

**The emergency flashers are used to warn other drivers when the vehicle has to be stopped in the road due to a breakdown, etc.**

Press the switch.

All the turn signals will flash.  
To turn them off, press the switch once again.

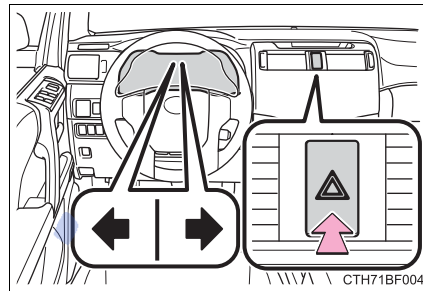

### ■ Emergency flashers

If the emergency flashers are used for a long time while the engine is not operating, the battery may discharge.

تلفن شبانه روزی: ۰۲۱-۸۸۶۲۰۸۵

FarmaSOS.com

## If your vehicle has to be stopped in an emergency

**Only in an emergency, such as if it becomes impossible to stop the vehicle in the normal way, stop the vehicle using the following procedure:**

- 1 Steadily step on the brake pedal with both feet and firmly depress it.  
Do not pump the brake pedal repeatedly as this will increase the effort required to slow the vehicle.
- 2 Shift the shift lever to N.
  - ▶ If the shift lever is shifted to N
- 3 After slowing down, stop the vehicle in a safe place by the road.
- 4 Stop the engine.
  - ▶ If the shift lever cannot be shifted to N
- 3 Keep depressing the brake pedal with both feet to reduce vehicle speed as much as possible.
- 4 Vehicles without a smart key system: Stop the engine by turning the engine switch to the "ACC" position.

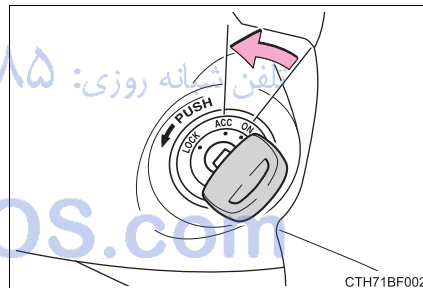

CTH71BF002

- 4 Vehicles with a smart key system: To stop the engine, press and hold the engine switch for 2 consecutive seconds or more, or press it briefly 3 times or more in succession.

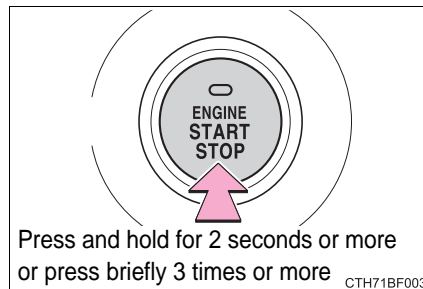

CTH71BF003

- 5 Stop the vehicle in a safe place by the road.

 CAUTION

■ **If the engine has to be turned off while driving**

- Power assist for the brakes and steering wheel will be lost, making the brake pedal harder to depress and the steering wheel heavier to turn. Decelerate as much as possible before turning off the engine.
- Vehicles without a smart key system:  
Never attempt to remove the key, as doing so will lock the steering wheel.

امداد خودرو فارما

تلفن شبانه روزی: ۰۲۱-۸۸۸۶۲۰۸۵

FarmaSOS.com



## If your vehicle needs to be towed

**If towing is necessary, we recommend having your vehicle towed by your Toyota dealer or a commercial towing service, using a lift-type truck or flat bed truck.**

**Use a safety chain system for all towing, and abide by all state/provincial and local laws.**

### Before towing

The following may indicate a problem with your transmission. Contact your Toyota dealer before towing.

- The engine is running but the vehicle will not move.
- The vehicle makes an abnormal sound.

### Emergency towing

If a tow truck is not available in an emergency, your vehicle may be temporarily towed using a cable or chain secured to the emergency towing eyelet(s). This should only be attempted on hard surfaced roads for short distances at low speeds.

A driver must be in the vehicle to steer and operate the brakes. The vehicle's wheels, drive train, axles, steering and brakes must be in good condition.

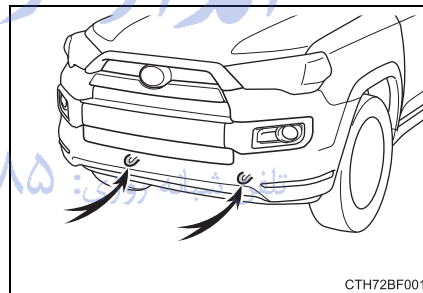

Vehicles with front covers only:  
Before using the front emergency  
towing eyelet(s), remove the  
cover(s).

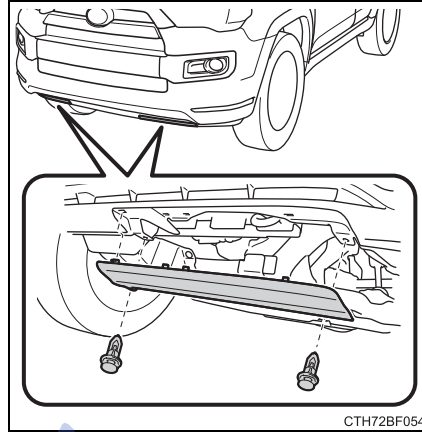

- ① Removing the clips
- ② Installing the clips

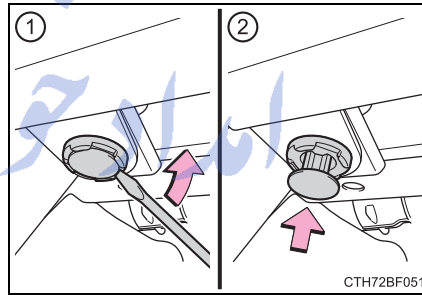

**Towing with a sling-type truck** تلفن شبانه روزی: ۰۸۵ ۲۱۱۶۲۰۲۱

Do not tow with a sling-type truck  
to prevent body damage.

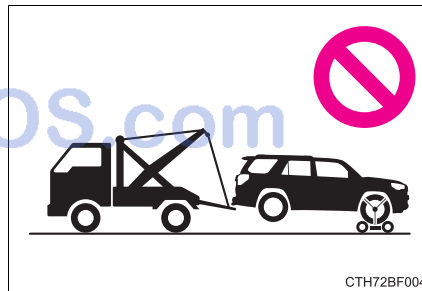

### Towing with a wheel-lift type truck

► From the front

Use a towing dolly under the rear wheels.

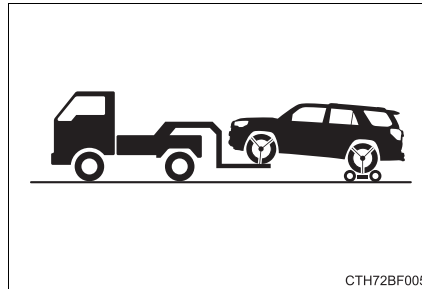

► From the rear (2WD models)

Vehicles without a smart key system: Turn the engine switch to the "ACC" position so that the steering wheel is unlocked.

Vehicles with a smart key system: Turn the engine switch to ACCESSORY mode so that the steering wheel is unlocked.

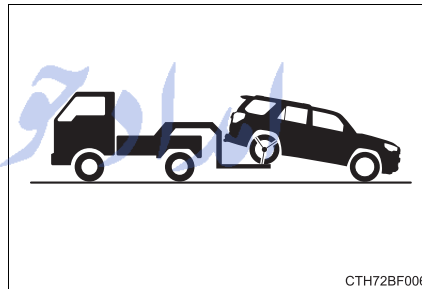

► From the rear (4WD models)

Full-time 4WD models: Use a towing dolly under the front wheels.

Part-time 4WD models: When not using a towing dolly, turn the engine switch to the "ACC" position, shift the shift lever to N and shift the front-wheel drive control lever or switch to H2.

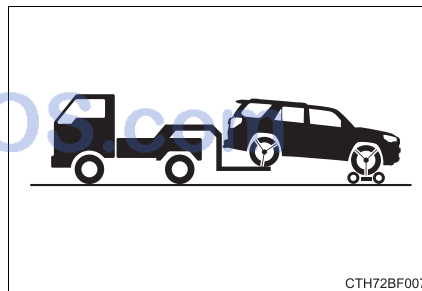

### Using a flat bed truck

If you use chains or cables to tie down your vehicle, the angles shaded in black must be 45°.

Do not overly tighten the tie downs or the vehicle may be damaged.

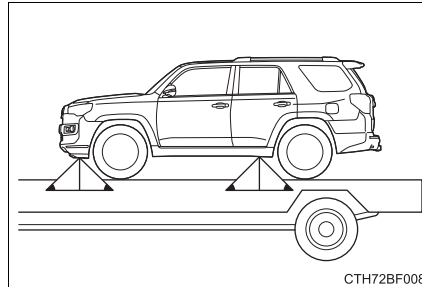

### Before emergency towing

- 1 Vehicles without a smart key system: Turn the engine switch to the “ACC” (engine off) or “ON” position.  
Vehicles with a smart key system: Turn the engine switch to ACCESSORY (engine off) or IGNITION ON mode (engine running).
- 2 Part-time 4WD models:
  - ▶ Type A  
Shift the front-wheel drive control lever to H2.
  - ▶ Type B  
Push the “UNLOCK” button and turn the front-wheel drive control switch to H2.Full-time 4WD models: Push the “UNLOCK” button and turn the four-wheel drive control switch to H4F. (The center differential is unlocked.)
- 3 Shift the shift lever to N.
- 4 Release the parking brake.

 CAUTION

**■ Caution while towing**

- Use extreme caution when towing the vehicle.  
Avoid sudden starts or erratic driving maneuvers which place excessive stress on the emergency towing eyelets and the cables or chains. Always be cautious of the surroundings and other vehicles while towing.
- Vehicles with a smart key system: Do not turn the engine switch off.  
Doing so will lock the steering wheel and prevent operation, possibly causing an accident and resulting in death or serious injury.
- If the engine is not running, the power assist for the brakes and steering will not function, making steering and braking more difficult.

 NOTICE

**■ To prevent causing serious damage to the transmission and transfer (4WD models) when towing using a wheel-lift type truck**

2WD models: Never tow this vehicle from the front with the rear wheels on the ground.

4WD models: Never tow this vehicle with any of the wheels in contact with the ground.

**■ To prevent damage to the vehicle when towing using a wheel-lift type truck**

- 2WD models without a smart key system: Do not tow the vehicle from the rear when the engine switch is in the "LOCK" position or the key is removed. The steering lock mechanism is not strong enough to hold the front wheels straight.
- 2WD models with a smart key system: Do not tow the vehicle from the rear when the engine switch is off. The steering lock mechanism is not strong enough to hold the front wheels straight.
- When raising the vehicle, ensure adequate ground clearance for towing at the opposite end of the raised vehicle. Without adequate clearance, the vehicle could be damaged while being towed.

**■ To prevent body damage when towing with a sling-type truck**

Do not tow with a sling-type truck, either from the front or rear.

**■ To prevent causing serious damage to the transmission and transfer (4WD models) in emergency towing**

Never tow a vehicle from the rear with four wheels on the ground. This may cause serious damage to the transmission and transfer.

## If you think something is wrong

**If you notice any of the following symptoms, your vehicle probably needs adjustment or repair. Contact your Toyota dealer as soon as possible.**

### Visible symptoms

- Fluid leaks under the vehicle.  
(Water dripping from the air conditioning after use is normal.)
- Flat-looking tires or uneven tire wear
- Engine coolant temperature gauge needle continually points higher than normal.

### Audible symptoms

- Changes in exhaust sound
- Excessive tire squeal when cornering
- Strange noises related to the suspension system
- Pinging or other noises related to the engine

### Operational symptoms

- Engine missing, stumbling or running roughly
- Appreciable loss of power
- Vehicle pulls heavily to one side when braking
- Vehicle pulls heavily to one side when driving on a level road
- Loss of brake effectiveness, spongy feeling, pedal almost touches the floor

## Fuel pump shut off system

**To minimize the risk of fuel leakage when the engine stalls or when an airbag inflates upon collision, the fuel pump shut off system stops the supply of fuel to the engine.**

Follow the procedure below to restart the engine after the system is activated.

▶ Vehicles without a smart key system

- 1 Turn the engine switch to the "ACC" or "LOCK" position.
- 2 Restart the engine.

▶ Vehicles with a smart key system

- 1 Turn the engine switch to ACCESSORY mode or turn it off.
- 2 Restart the engine.

### NOTICE

#### ■ Before starting the engine

Inspect the ground under the vehicle.







If you find that fuel has leaked onto the ground, the fuel system has been damaged and is in need of repair. Do not restart the engine.

FarmaSOS.com







## If a warning light turns on or a warning buzzer sounds









Calmly perform the following actions if any of the warning lights comes on or flashes. If a light comes on or flashes, but then goes off, this does not necessarily indicate a malfunction in the system. However, if this continues to occur, have the vehicle inspected by your Toyota dealer.





### Warning light and warning buzzer list

Warning light	Warning light/Details/Actions
 (U.S.A.)  (Canada)	<b>Brake system warning light (warning buzzer)*<sup>1</sup></b> <ul style="list-style-type: none"> <li>• Low brake fluid</li> <li>• Malfunction in the brake system</li> </ul> This light also comes on when the parking brake is not released. If the light turns off after the parking brake is fully released the system is operating normally. → <b>Immediately stop the vehicle in a safe place and contact your Toyota dealer. Continuing to drive the vehicle may be dangerous.</b>
	<b>Charging system warning light</b> Indicates a malfunction in the vehicle's charging system → <b>Immediately stop the vehicle in a safe place and contact your Toyota dealer.</b>
	<b>Low engine oil pressure warning light</b> Indicates that the engine oil pressure is too low → <b>Immediately stop the vehicle in a safe place and contact your Toyota dealer.</b>
 (U.S.A.)  (Canada)	<b>Malfunction indicator lamp</b> Indicates a malfunction in: <ul style="list-style-type: none"> <li>• The emission control system;</li> <li>• The electronic engine control system;</li> <li>• The electronic throttle control system; or</li> <li>• The electronic automatic transmission control system</li> </ul> → <b>Have the vehicle inspected by your Toyota dealer immediately.</b>



Warning light	Warning light/Details/Actions
	<p><b>SRS warning light</b> Indicates a malfunction in:</p> <ul style="list-style-type: none"> <li>• The SRS airbag system;</li> <li>• The front passenger occupant classification system;</li> <li>or</li> <li>• The seat belt pretensioner system</li> </ul> <p>→ <b>Have the vehicle inspected by your Toyota dealer immediately.</b></p>
<p> (U.S.A.)</p> <p> (Canada)</p>	<p><b>ABS warning light</b> Indicates a malfunction in:</p> <ul style="list-style-type: none"> <li>• The ABS; or</li> <li>• The brake assist system</li> </ul> <p>→ <b>Have the vehicle inspected by your Toyota dealer immediately.</b></p>
<p> (Flashes)</p>	<p><b>Cruise control indicator light</b> Indicates a malfunction in the cruise control system</p> <p>→ <b>Have the vehicle inspected by your Toyota dealer immediately.</b></p>
<p></p>	<p><b>Slip indicator</b> Indicates a malfunction in:</p> <ul style="list-style-type: none"> <li>• The VSC system;</li> <li>• Trailer Sway Control system;</li> <li>• The TRAC system;</li> <li>• The active traction control system;</li> <li>• The AUTO LSD system;</li> <li>• The downhill assist control system;</li> <li>• The hill-start assist control system; or</li> <li>• The Crawl Control system</li> </ul> <p>→ <b>Have the vehicle inspected by your Toyota dealer immediately.</b></p>
<p> (Flashes rapidly)</p>	<p><b>Rear differential lock indicator light (if equipped)</b> Indicates a malfunction in the rear differential lock system</p> <p>→ <b>Have the vehicle inspected by your Toyota dealer immediately.</b></p>
<p> (Flashes rapidly)</p>	<p><b>Four-wheel drive indicator light (if equipped)</b> Indicates a malfunction in the four-wheel drive system</p> <p>→ <b>Have the vehicle inspected by your Toyota dealer immediately.</b></p>

Warning light	Warning light/Details/Actions
 (Flashes rapidly)	<b>Low speed four-wheel drive indicator light (if equipped)</b> Indicates a malfunction in the four-wheel drive system → <b>Have the vehicle inspected by your Toyota dealer immediately.</b>
 (Flashes rapidly)	<b>Center differential lock indicator light (if equipped)</b> Indicates a malfunction in the four-wheel drive system → <b>Have the vehicle inspected by your Toyota dealer immediately.</b>
 (Flashes continuously)	<b>Multi-terrain Select indicator light (if equipped)</b> Indicates a malfunction in the Multi-terrain Select system → <b>Have the vehicle inspected by your Toyota dealer immediately.</b>
	<b>Power steering warning light</b> Indicates a malfunction in the power steering system → <b>Have the vehicle inspected by your Toyota dealer immediately.</b>
	<b>Unengaged "Park" warning light (if equipped)</b> Indicates a malfunction in the transmission "Park" mechanism. → <b>Have the vehicle inspected by your Toyota dealer immediately.</b>
	<b>KDSS warning light (if equipped)</b> Indicates a malfunction in KDSS → <b>Have the vehicle inspected by your Toyota dealer immediately.</b>
 (Flashes)	<b>Automatic running boards indicator light (if equipped)</b> Indicates a malfunction in Automatic running boards → <b>Have the vehicle inspected by your Toyota dealer immediately.</b>
	<b>Open door warning light (warning buzzer)*2</b> Indicates that a door is not fully closed → <b>Check that all the doors are closed.</b>
	<b>Low fuel level warning light</b> Indicates remaining fuel is approximately 3.5 gal. (13.1 L, 2.9 Imp. gal.) or less → <b>Refuel the vehicle.</b>

Warning light	Warning light/Details/Actions
	<p><b>Seat belt reminder light (warning buzzer)*<sup>3</sup></b>  Warns the driver and/or front passenger to fasten their seat belts  → <b>Fasten the seat belt.</b>  <b>If the front passenger's seat is occupied, the front passenger's seat belt also needs to be fastened to make the warning light (warning buzzer) turn off.</b></p>
	<p><b>Smart key system indicator light</b>  Indicates malfunction in the smart key system.  → <b>P. 426</b></p>
	<p><b>Master warning light</b>  A buzzer sounds and warning light comes on flashes to indicate that the master warning system has detected a malfunction.  → <b>P. 426</b></p>
	<p><b>Tire pressure warning light</b>  When the light comes on:  Low tire inflation pressure such as  • Natural causes (→P. 423)  • Flat tire (→P. 433)  → <b>Adjust the tire inflation pressure (including the spare tire) to the specified level.</b>  <b>The light will turn off after a few minutes. In case the light does not turn off even if the tire inflation pressure is adjusted, have the system checked by your Toyota dealer.</b>  When the light comes on after blinking for 1 minute:  Malfunction in the tire pressure warning system (→P. 423)  → <b>Have the system checked by your Toyota dealer.</b></p>

**\*1: Parking brake engaged warning buzzer:**

A buzzer will sound if the vehicle is driven at a speed of approximately 3 mph (5 km/h) or more.

**\*2: Open door warning buzzer:**

The open door warning buzzer sounds to alert one or more of the doors is not fully closed (with the vehicle having reached a speed of 3 mph [5 km/h]).

**\*3: Driver's and front passenger's seat belt buzzer:**

The driver's and front passenger's seat belt buzzer sounds to alert the driver and front passenger that his or her seat belt is not fastened. The buzzer sounds intermittently for 10 seconds after the vehicle reaches a speed of 12 mph (20 km/h). Then, if the seat belt is still unfastened, the buzzer will sound in a different tone for 20 more seconds.

**■ SRS warning light**

This warning light system monitors the airbag sensor assembly, front impact sensors, side impact sensors (front door), side impact sensors (rear), safing sensor (rear), driver's seat belt buckle switch, front passenger occupant classification system (ECU and sensors), "AIR BAG ON" and "AIR BAG OFF" indicator lights, front passenger's seat belt buckle switch, seat belt pretensioners, airbags, interconnecting wiring and power sources. (→P. 35)

**■ Key reminder buzzer (vehicles without a smart key system)**

The buzzer indicates that the key has not been removed with the engine off and the driver's door opened.

**■ Open moon roof reminder buzzer (if equipped)**

The buzzer indicates that the moon roof is not fully closed with the engine off and the driver's door opened.

**■ Front passenger detection sensor, passenger seat belt reminder and warning buzzer**

- If luggage is placed on the front passenger seat, the front passenger detection sensor may cause the warning light to flash and the warning buzzer to sound even if a passenger is not sitting in the seat.
- If a cushion is placed on the seat, the sensor may not detect a passenger, and the warning light may not operate properly.

**■ If the malfunction indicator lamp comes on while driving**

First check the following:

- Is the fuel tank empty?  
If it is, fill the fuel tank immediately.
- Is the fuel tank cap loose?  
If it is, tighten it securely.

The light will go off after several driving trips.

If the light does not go off even after several trips, contact your Toyota dealer as soon as possible.

**■ The tire pressure warning light may come on due to natural causes**

The tire pressure warning light may come on due to natural causes such as natural air leaks and tire inflation pressure changes caused by temperature. In this case, adjusting the tire inflation pressure will turn off the warning light (after a few minutes).

**■ When a tire is replaced with a spare tire**

The spare tire is not equipped with a tire pressure warning valve and transmitter. If a tire goes flat, the tire pressure warning light will not turn off even though the flat tire has been replaced with the spare tire. Replace the spare tire with the repaired tire and adjust the tire inflation pressure. The tire pressure warning light will go off after a few minutes.

**■ If the tire pressure warning system is not functioning**

The tire pressure warning system will be disabled in the following conditions:

(When the condition becomes normal, the system will work properly.)

- If tires not equipped with tire pressure warning valves and transmitters are used
- If the ID code on the tire pressure warning valves and transmitters is not registered in the tire pressure warning computer
- If the tire inflation pressure is 73 psi (500 kPa, 5.1 kgf/cm<sup>2</sup> or bar) or higher

The tire pressure warning system may be disabled in the following conditions:

(When the condition becomes normal, the system will work properly.)

- If electronic devices or facilities using similar radio wave frequencies are nearby
- If a radio set at a similar frequency is in use in the vehicle
- If a window tint that affects the radio wave signals is installed
- If there is a lot of snow or ice on the vehicle, particularly around the wheels or wheel housings
- If non-genuine Toyota wheels are used (Even if you use Toyota wheels, the tire pressure warning system may not work properly with some types of tires.)
- If tire chains are used

**■ If the tire pressure warning light frequently comes on after blinking for 1 minute**

If the tire pressure warning light frequently comes on after blinking for 1 minute when the engine switch is turned on, have it checked by your Toyota dealer.

**■ Customization that can be configured at Toyota dealer**

The vehicle speed linked seat belt reminder buzzer can be disabled. (Customizable features →P. 485) However, Toyota recommends that the seat belt reminder buzzer be operational to alert the driver and front passenger when seat belts are not fastened.

 CAUTION**■ If the tire pressure warning light comes on**

Be sure to observe the following precautions. Failure to do so could cause a loss of vehicle control and result in death or serious injury.

- Stop your vehicle in a safe place as soon as possible. Adjust the tire inflation pressure immediately.
- If the tire pressure warning light comes on even after tire inflation pressure adjustment, it is probable that you have a flat tire. Check the tires. If a tire is flat, change it with the spare tire and have the flat tire repaired by the nearest Toyota dealer.
- Avoid abrupt maneuvering and braking. If the vehicle tires deteriorate, you could lose control of the steering wheel or the brakes.

**■ If a blowout or sudden air leakage should occur**

The tire pressure warning system may not activate immediately.

**■ Maintenance of the tires**

Each tire, including the spare (if provided), should be checked monthly when cold and inflated to the inflation pressure recommended by the vehicle manufacturer on the vehicle placard or tire inflation pressure label (tire and load information label). (If your vehicle has tires of a different size than the size indicated on the vehicle placard or tire inflation pressure label [tire and load information label], you should determine the proper tire inflation pressure for those tires.)

As an added safety feature, your vehicle has been equipped with a tire pressure monitoring system (TPMS-tire pressure warning system) that illuminates a low tire pressure telltale (tire pressure warning light) when one or more of your tires is significantly under-inflated. Accordingly, when the low tire pressure telltale (tire pressure warning light) illuminates, you should stop and check your tires as soon as possible, and inflate them to the proper pressure. Driving on a significantly under-inflated tire causes the tire to overheat and can lead to tire failure. Under-inflation also reduces fuel efficiency and tire tread life, and may affect the vehicle's handling and stopping ability.

Please note that the TPMS (tire pressure warning system) is not a substitute for proper tire maintenance, and it is the driver's responsibility to maintain correct tire pressure, even if under-inflation has not reached the level to trigger illumination of the TPMS low tire pressure telltale (tire pressure warning light).

 CAUTION

Your vehicle has also been equipped with a TPMS (tire pressure warning system) malfunction indicator to indicate when the system is not operating properly. The TPMS (tire pressure warning system) malfunction indicator is combined with the low tire pressure telltale (tire pressure warning light). When the system detects a malfunction, the telltale will flash for approximately one minute and then remain continuously illuminated. This sequence will continue upon subsequent vehicle start-ups as long as the malfunction exists. When the malfunction indicator is illuminated, the system may not be able to detect or signal low tire pressure as intended.

TPMS (tire pressure warning system) malfunctions may occur for a variety of reasons, including the installation of replacement or alternate tires or wheels on the vehicle that prevent the TPMS (tire pressure warning system) from functioning properly. Always check the TPMS (tire pressure warning system) malfunction telltale after replacing one or more tires or wheels on your vehicle to ensure that the replacement or alternate tires and wheels allow the TPMS (tire pressure warning system) to continue to function properly.

 NOTICE**■ Precaution when installing a different tire**

When a tire of a different specification or maker is installed, the tire pressure warning system may not operate properly.

FarmaSOS.com

7

When trouble arises

If a warning message or indicator is displayed

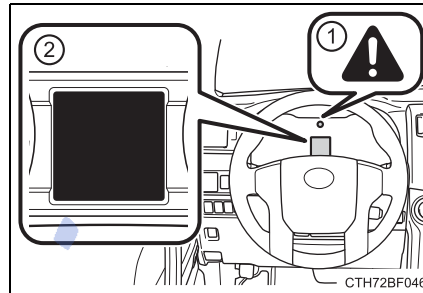

If a warning is shown on the multi-information display, stay calm and perform the following actions:

- ① Master warning light  
The master warning light also comes on or flashes in order to indicate that a message is currently being displayed on the multi-information display.
- ② Multi-information display











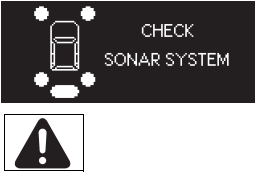

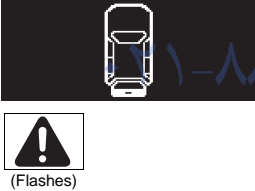
If any of the warning message or indicator comes on again after the following actions have been performed, contact your Toyota dealer.

Warning message and warning buzzer list



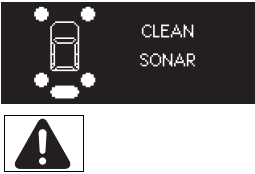

Warning message	Details/Actions
<p>CHECK STEERING LOCK SYSTEM</p> 	<p>Indicates a malfunction in the steering lock system A buzzer also sounds. → <b>Have the vehicle inspected by your Toyota dealer.</b></p>
<p>CHECK TRANSMISSION SYSTEM</p> 	<p>Indicates a malfunction in the automatic transmission system A buzzer also sounds. → <b>Have the vehicle inspected by your Toyota dealer.</b></p>
<p>HIGH TRANSMISSION FLUID TEMPERATURE</p> 	<p>Indicates that the automatic transmission fluid temperature is too high A buzzer also sounds. → <b>Stop the vehicle in a safe place, shift the shift lever to P and wait until the message goes off. If the message goes off, you may start the vehicle again. If the message does not go off, contact your Toyota dealer.</b></p>









Warning message	Details/Actions
	<p>Indicates a malfunction in the intuitive parking assist-sensor            The site of the malfunction flashes and stays on.            A buzzer will sound for several seconds and this warning message will disappear after several seconds.            If the engine switch is turned to a mode other than IGNITION ON mode and then back to IGNITION ON mode, the buzzer will sound and this message will be displayed again.            → <b>Have the vehicle inspected by your Toyota dealer.</b></p>
	<p>Indicates that one or more of the doors is not fully closed            If the vehicle reaches a speed of 3 mph (5 km/h),   flashes and a buzzer sounds to indicate that the door(s) are not yet fully closed.            → <b>Make sure that all the doors are closed.</b></p>
	<p>Indicates that the back door is not fully closed            If the vehicle reaches a speed of 3 mph (5 km/h),   flashes and a buzzer sounds to indicate that the back door is not yet fully closed.            → <b>Close the back door.</b></p>
	<p>Indicates that the moon roof is not fully closed (with the engine switch off, and the driver's door open)            A buzzer also sounds.            → <b>Close the moon roof.</b></p>
	<p>Indicates that the parking brake is still engaged            If the vehicle reaches a speed of 3 mph (5 km/h),   flashes and a buzzer sounds to indicate that the parking brake is still engaged.            → <b>Release the parking brake.</b></p>
	<p>Indicates that the washer fluid level is low.            → <b>Add washer fluid.</b></p>



Warning message	Details/Actions
	<p>Indicates that an intuitive parking assist-sensor is dirty or covered with ice                      The site of the malfunction flashes and stays on.                      A buzzer will sound for several seconds and this warning message will disappear after several seconds.                      If the engine switch is turned to a mode other than IGNITION ON mode and then back to IGNITION ON mode, the buzzer will sound and this message will be displayed again.                      → <b>Clean the sensor.</b></p>
	<p>Indicates that all maintenance according to the driven distance on the maintenance schedule* should be performed soon.                      Comes on approximately 4500 miles (7200 km) after the maintenance data has been reset.                      → <b>If necessary, perform maintenance.</b></p>
	<p>Indicates that all maintenance is required to correspond to the driven distance on the maintenance schedule*.                      Comes on approximately 5000 miles (8000 km) after the maintenance data has been reset.                      (The indicator will not work properly unless the maintenance data has been reset.)                      → <b>Perform the necessary maintenance. Please reset the maintenance data after the maintenance is performed (→P. 348)</b></p>

\*: Refer to the separate "Scheduled Maintenance Guide" or "Owner's Manual Supplement" for the maintenance interval applicable to your vehicle.

Interior buzzer	Exterior buzzer	Warning message	Details/Actions
Once	—	<p>KEY NOT DETECTED</p>  <p>(Flashes)</p>	<p>The electronic key is not detected when an attempt is made to start the engine.</p> <p>→ <b>Start the engine with the electronic key present.</b></p>
Once	3 times	<p>KEY NOT DETECTED</p>  <p>(Flashes)</p>	<p>The electronic key was carried outside the vehicle and a door other than the driver's door was opened and closed while the engine switch was in a mode other than off.</p> <p>→ <b>Bring the electronic key back into the vehicle.</b></p> <p>The driver's door was opened and closed while the electronic key was not in the vehicle, the shift lever was in P and the engine switch was not turned off.</p> <p>→ <b>Turn the engine switch off or bring the electronic key back into the vehicle.</b></p>
Once	Continuous (5-seconds)	<p>KEY NOT DETECTED</p> <p>TURN POWER OFF (Displayed alternately)</p>  <p>(Flashes)</p>	<p>An attempt was made to exit the vehicle with the electronic key and lock the doors without first turning the engine switch off when the shift lever was in P.</p> <p>→ <b>Turn the engine switch off and lock the doors again.</b></p>
Once	—	<p>KEY NOT DETECTED</p>  <p>(Flashes)</p>	<p>An attempt was made to drive when the regular key was not inside the vehicle.</p> <p>→ <b>Confirm that the electronic key is inside the vehicle.</b></p>
Continuous	—	<p>SHIFT TO P POSITION</p>  <p>(Flashes)</p>	<p>The driver's door was opened while any shift lever other than P was selected without turning off the engine switch.</p> <p>→ <b>Shift the shift lever to P.</b></p>

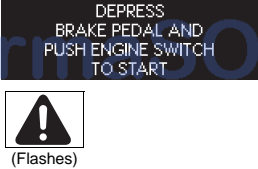
Interior buzzer	Exterior buzzer	Warning message	Details/Actions
Continuous	Continuous	<p>SHIFT TO P POSITION</p> <p>KEY NOT DETECTED (Displayed alternately)</p>  <p>(Flashes)</p>	<p>The driver's door was opened and closed while the electronic key was not in the vehicle, the shift lever was not in P and the engine switch was not turned off.</p> <p>→ <b>Shift the shift lever to P. Bring the electronic key back into the vehicle.</b></p>
Once	Continuous	<p>KEY DETECTED IN VEHICLE</p>  <p>(Flashes)</p>	<p>An attempt was made to lock the doors using the smart entry &amp; start system while the electronic key was still inside the vehicle.</p> <p>→ <b>Retrieve the electronic key from the vehicle and lock the doors again.</b></p>
—	Continuous	<p>KEY DETECTED IN VEHICLE</p>  <p>(Flashes)</p>	<p>An attempt was made to lock either front door by opening a door and putting the inside lock button into the lock position, then closing the door by pulling on the outside door handle with the electronic key still inside the vehicle.</p> <p>→ <b>Retrieve the electronic key from the vehicle and lock the doors again.</b></p>
Once	—	<p>DEPRESS BRAKE PEDAL, TOUCH ENGINE SWITCH WITH KEY</p>  <p>(Flashes)</p>	<ul style="list-style-type: none"> <li>• When the doors were unlocked with the mechanical key and then the engine switch was pressed, the electronic key could not be detected in the vehicle.</li> <li>• The electronic key could not be detected in the vehicle even after the engine switch was pressed two consecutive times.</li> </ul> <p>→ <b>Touch the electronic key to the engine switch while depressing the brake pedal.</b></p>

Interior buzzer	Exterior buzzer	Warning message	Details/Actions
Once	—	 <p>SHIFT TO P POSITION TO START</p> <p>(Flashes)</p>	<p>An attempt was made to start the engine with the shift lever in an incorrect position.</p> <p>→ <b>Shift the shift lever to P and start the engine.</b></p>
—	—	 <p>AUTO POWER OFF TO CONSERVE BATTERY</p>	<p>Power was turned off due to the automatic power off function.</p> <p>→ <b>Next time when starting the engine, increase the engine speed slightly and maintain that level for approximately 5 minutes to recharge the battery.</b></p>
Once	—	 <p>KEY BATTERY LOW</p>	<p>The electronic key has a low battery.</p> <p>→ <b>Replace the electronic key battery. (→P. 386)</b></p>
Once	—	 <p>DEPRESS BRAKE PEDAL AND PUSH ENGINE SWITCH TO START</p> <p>(Flashes)</p>	<p>The driver's door was opened and closed with the engine switch turned off and then the engine switch was put in ACCESSORY or IGNITION ON mode twice without the engine being started.</p> <p>→ <b>Press the engine switch while depressing the brake pedal.</b></p> <p>During an engine starting procedure in the event that the electronic key was not functioning properly (→P. 450), the engine switch was touched with the electronic key.</p> <p>→ <b>Press the engine switch while depressing the brake pedal within 10 seconds of the buzzer sounding.</b></p>

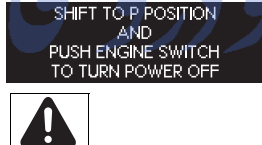
Interior buzzer	Exterior buzzer	Warning message	Details/Actions
Once	—	 <p>STEERING LOCK ACTIVE</p> <p>(Flashes)</p>	<p>The steering lock could not be released within 3 seconds of the engine switch being pressed.</p> <p>→ <b>Press the engine switch while depressing the brake pedal and moving the steering wheel left and right.</b></p>
Once	—	 <p>SHIFT TO P POSITION</p> <p>(Flashes)</p>	<p>The engine switch has been turned off with the shift lever in a position other than P or N.</p> <p>→ <b>Shift the shift lever to P.</b></p>
Once	—	 <p>SHIFT TO P POSITION AND PUSH ENGINE SWITCH TO TURN POWER OFF</p> <p>(Flashes)</p>	<p>An attempt was made to turn the engine switch off when the shift lever was not in P.</p> <p>→ <b>To turn off the engine, first shift the shift lever to P and then turn the engine switch off.</b></p>

■ **Warning buzzer**

In some cases, the buzzer may not be heard because of noisy place or an audio sound.

FarmaSOS.com

## If you have a flat tire

**Remove the flat tire and replace it with the spare tire provided.**

**For details about tires: →P. 372**

### CAUTION

#### ■ If you have a flat tire

Do not continue driving with a flat tire.

Driving even a short distance with a flat tire can damage the tire and the wheel beyond repair, which could result in an accident.

### You will need the following item:

- Phillips screwdriver

### Before jacking up the vehicle

- Stop the vehicle on a hard, flat surface.
- Set the parking brake.
- Shift the shift lever to P.
- Stop the engine.
- Turn on the emergency flashers. (→P. 408)

FarmaSOS.com

**Location of the spare tire, jack and tools**

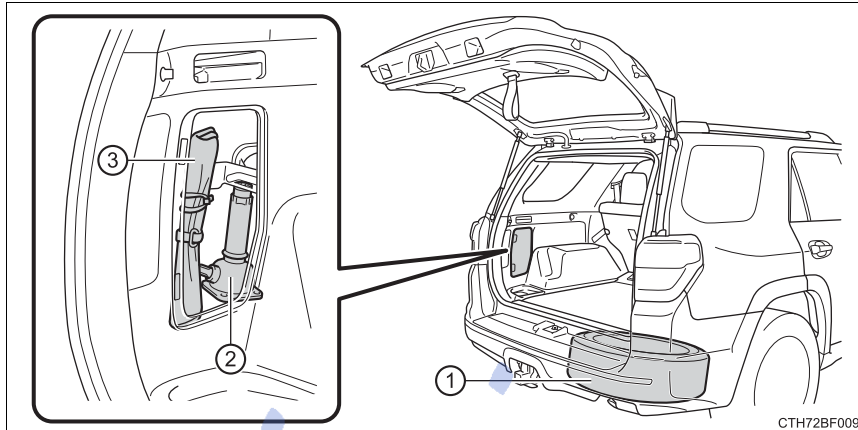

- ① Spare tire
- ② Jack
- ③ Tool bag

امداد خودرو فارسا  
تلفن شبانه روزی: ۰۲۱-۸۸۸۶۲۰۸۵

FarmaSOS.com



 CAUTION**■ Using the tire jack**

Improper use of the tire jack may cause the vehicle to suddenly fall off the jack, leading to death or serious injury.

- Do not use the tire jack for any purpose other than replacing tires or installing and removing tire chains.
- Only use the tire jack that comes with this vehicle for replacing a flat tire.  
Do not use it on other vehicles, and do not use other tire jacks for replacing tires on this vehicle.
- Always check that the tire jack is securely set to the jack point.
- Do not put any part of your body under the vehicle while it is supported by the jack.
- Do not start or run the engine while your vehicle is supported by the jack.
- Do not raise the vehicle while someone is inside.
- When raising the vehicle, do not put an object on or under the jack.
- Do not raise the vehicle to a height greater than that required to replace the tire.
- Use a jack stand if it is necessary to get under the vehicle.

**► Vehicles with Automatic running boards**

- Observe the following precautions. Failure to do so may result in serious injury:
  - When jacking up the vehicle, always turn the Automatic running boards switch off.
  - When jacking up the vehicle, do not use an Automatic running board as a jack point. The Automatic running board may break, causing injuries.

Take particular care when lowering the vehicle to ensure that no one working on or near the vehicle may be injured.

**■ Using the jack handle**

Tighten all the jack handle bolts securely using a Phillips-head screwdriver, to prevent the extension parts from coming apart unexpectedly.

### Taking out the jack and tool bag

- 1 Remove the cover.

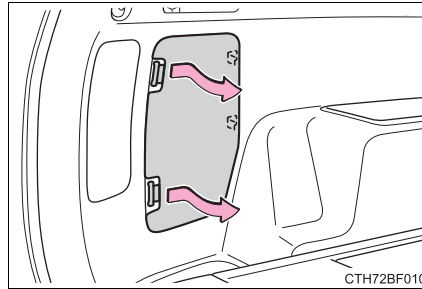

- 2 Unhook and take out the tool bag.

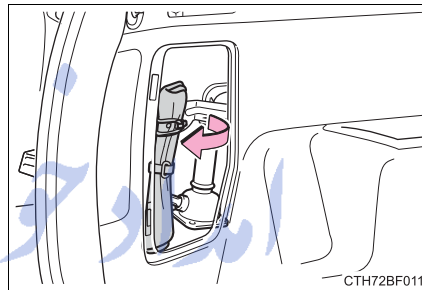

- 3 Take out the jack.

- ① For loosening
- ② For tightening

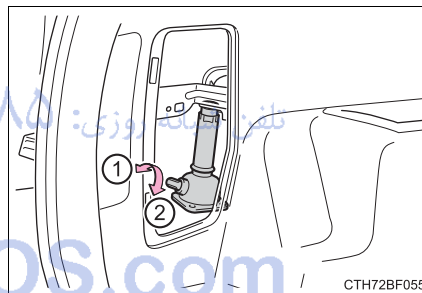

### Taking out the spare tire

#### 1 Assembling the jack handle.

Remove the jack handle and the jack handle extension bar from the tool bag and assembly by following these steps.

- ① Loosen the bolt and the screw using either the jack handle or a screwdriver.

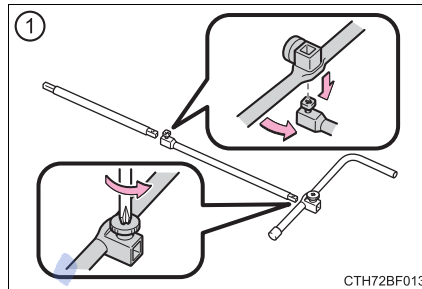

- ② Assemble the jack handle extension bars and tighten the bolt.

Check that the bolt is firmly tightened.

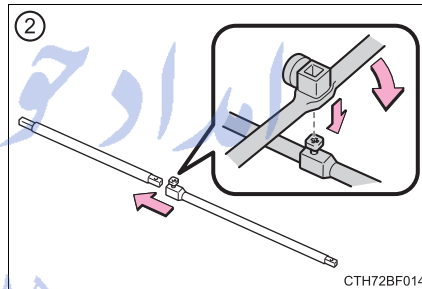

- ③ Assemble the jack handle and the jack handle extension bar and tighten the screw.

Check that the screw is firmly tightened.

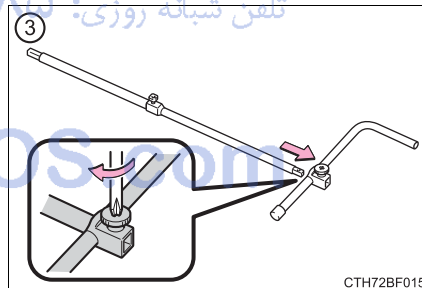

- 2 Insert the end of the jack handle extension into the lowering screw and turn it counterclockwise.

Lower the spare tire completely to the ground.

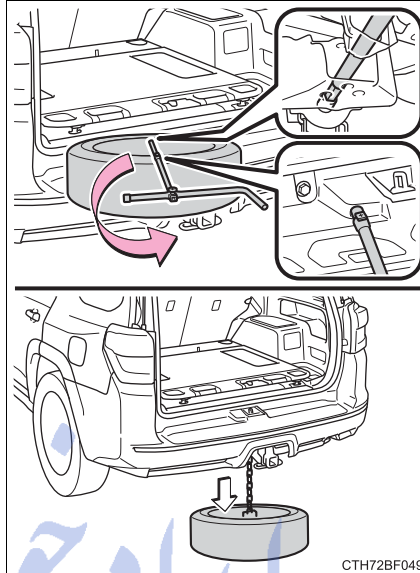

- 3 Pull out the spare tire and remove the holding bracket.

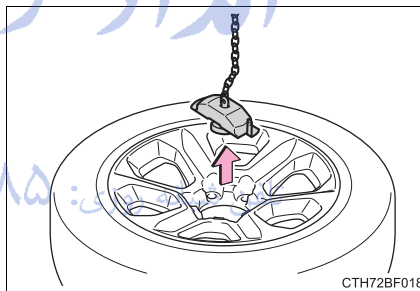

FarmaSOS.com

### Replacing a flat tire

- 1 Check the tires.

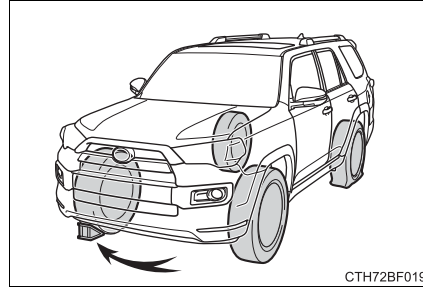

	Flat tire	Wheel chock positions
Front	Left-hand side	Behind the rear right-hand side tire
	Right-hand side	Behind the rear left-hand side tire
Rear	Left-hand side	In front of the front right-hand side tire
	Right-hand side	In front of the front left-hand side tire

- 2 Remove the wheel ornament using the wheel ornament remover.

To protect the wheel ornament, place a rag between the wheel ornament remover and the wheel ornament, as shown in the illustration.

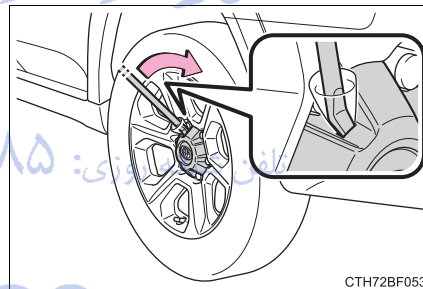

- 3 Slightly loosen the wheel nuts (one turn).

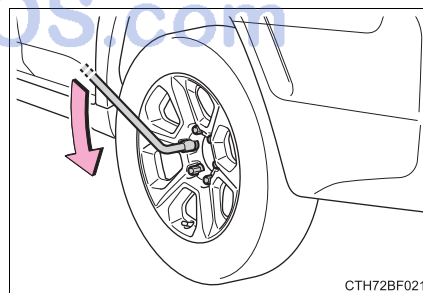

**4** Assembling the jack handle.

Remove the jack handle, jack handle extension bar and jack handle bar from the tool bag and assemble by following these steps.

- ① Loosen the bolts and the screw using either the jack handle or a screwdriver.

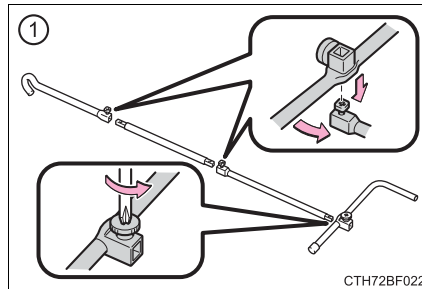

- ② Assemble the jack handle extension bars and the jack handle bar and tighten the bolts.
- Check that the bolts are firmly tightened.

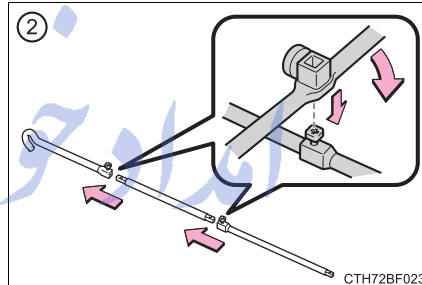

- ③ Assemble the jack handle extension bar and the jack handle and tighten the screw.
- Check that the screw is firmly tightened.

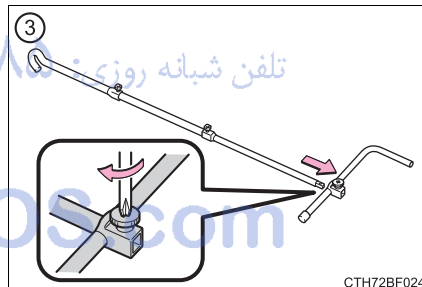

- 5 Position the jack at the jack points as shown.

Front - Under the chassis frame side rail

Rear - Under the rear axle housing

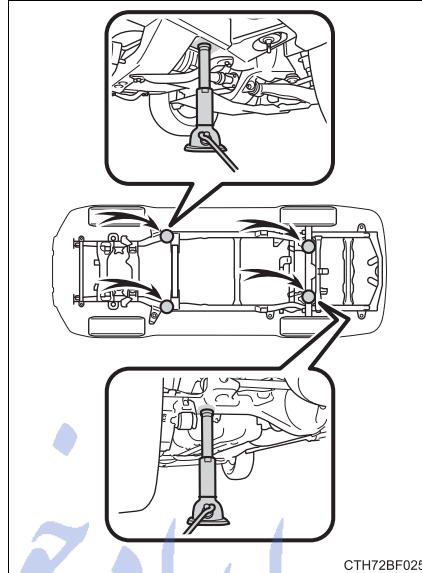

- 6 Raise the vehicle until the tire is slightly raised off the ground.

When positioning the jack under the rear axle housing, make sure the groove on the top of the jack fits with the rear axle housing.

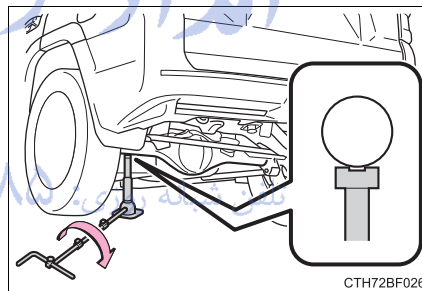

- 7 Remove all the wheel nuts and the tire.

When resting the tire on the ground, place the tire so that the wheel design faces up to avoid scratching the wheel surface.

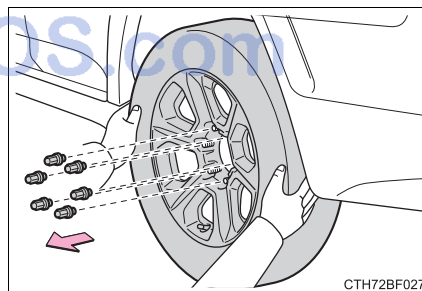

 CAUTION

■ Replacing a flat tire

- Observe the following precautions.  
Failure to do so may result in serious injury:
  - Lower the spare tire completely to the ground before removing it from under the vehicle.
  - Do not try to remove the wheel ornament by hand. Take due care in handling the ornament to avoid unexpected personal injury.
  - Do not attach a heavily damaged wheel ornament, as it may fly off the wheel while the vehicle is moving.
  - Do not touch the disc wheels or the area around the brakes immediately after the vehicle has been driven.  
After the vehicle has been driven the disc wheels and the area around the brakes will be extremely hot. Touching these areas with hands, feet or other body parts while changing a tire, etc. may result in burns.
- Failure to follow these precautions could cause the wheel nuts to loosen and the tire to fall off, resulting in death or serious injury.
  - Have the wheel nuts tightened with a torque wrench to 81 ft•lbf (110 N•m, 11.2 kgf•m) as soon as possible after changing wheels.
  - When installing a tire, only use wheel nuts that have been specifically designed for that wheel.
  - If there are any cracks or deformations in the bolt screws, nut threads or bolt holes of the wheel, have the vehicle inspected by your Toyota dealer.
  - When installing the wheel nuts, be sure to install them with the tapered ends facing inward. (→P. 381)

FarmaSOS.com



### Installing the spare tire

- 1 Remove any dirt or foreign matter from the wheel contact surface.

If foreign matter is on the wheel contact surface, the wheel nuts may loosen while the vehicle is in motion, causing the tire to come off.

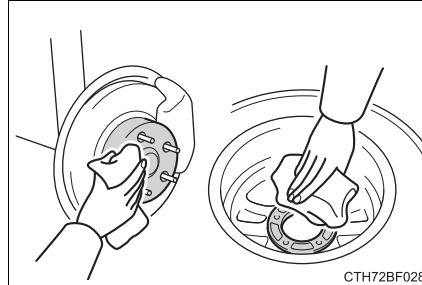

- 2 Install the spare tire and loosely tighten each wheel nut by hand by approximately the same amount.

When replacing an aluminum wheel with a steel wheel, tighten the wheel nuts until the tapered portion comes into loose contact with the disc wheel seat.

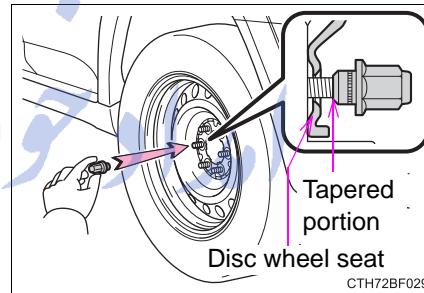

When replacing an aluminum wheel with an aluminum wheel, tighten the wheel nuts until the washers come into contact with the disc wheel.

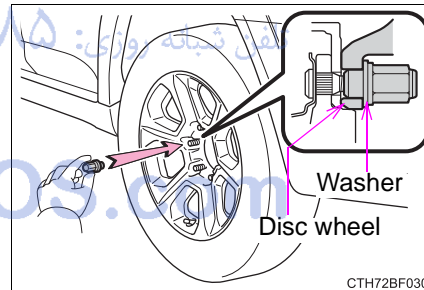

- 3 Lower the vehicle.

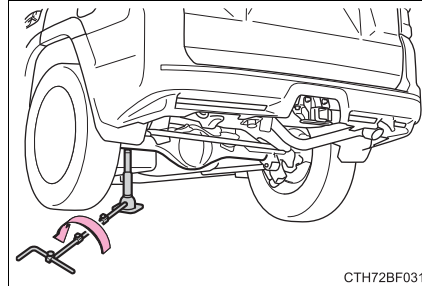

- 4 Firmly tighten each wheel nut two or three times in the order shown in the illustration.

Tightening torque:  
81 ft•lbf (110 N•m, 11.2 kgf•m)

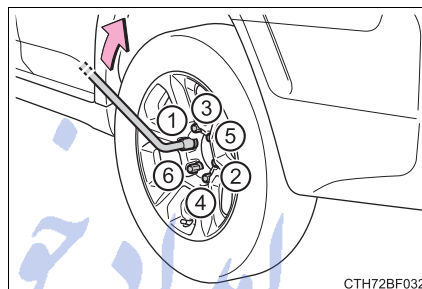

### Stowing the flat/spare tire, jack and tools

- 1 Lay down the tire with the outer side facing up, and install the holding bracket.

Insert the holding bracket tab into one of the holes in the wheel.

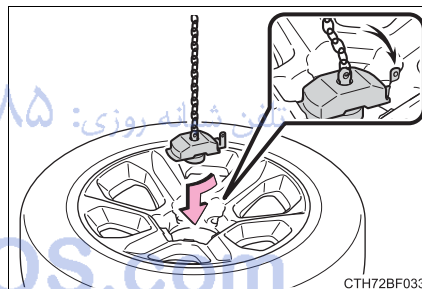

- 2 Raise the tire.  
Vehicles with kinetic dynamic suspension: Pull the tire toward the rear of the vehicle when raising. After raising, visually check that tire is not interfering with components.
- 3 Stow the tools and jack securely, and replace the cover.

### ■ After completing the tire change

The tire pressure warning system must be reset. (→P. 373)

### ■ When using the spare tire

As the spare tire is not equipped with a tire pressure warning valve and transmitter, low inflation pressure of the spare tire will not be indicated by the tire pressure warning system. Also, if you replace the spare tire after the tire pressure warning light comes on, the light remains on.

#### NOTICE

#### ■ Do not drive the vehicle with a flat tire

Do not continue driving with a flat tire.

Driving even a short distance with a flat tire can damage the tire and the wheel beyond repair.

#### ■ When stowing the flat tire

Ensure that there is no object caught between the tire and the vehicle underbody.

#### ■ When replacing the tires

- When removing or fitting the wheels, tires or the tire pressure warning valve and transmitter, contact your Toyota dealer as the tire pressure warning valve and transmitter may be damaged if not handled correctly.

- Replace the grommets for the tire pressure warning valves and transmitters as well.

#### ■ To avoid damage to the tire pressure warning valves and transmitters

When a tire is repaired with liquid sealants, the tire pressure warning valve and transmitter may not operate properly. If a liquid sealant is used, contact your Toyota dealer or other qualified service shop as soon as possible. Make sure to replace the tire pressure warning valve and transmitter when replacing the tire. (→P. 373)

## If the engine will not start

**If the engine will not start even though correct starting procedures are being followed (→P. 192, 195), consider each of the following points:**

### **The engine will not start even though the starter motor operates normally.**

One of the following may be the cause of the problem:

- There may not be sufficient fuel in the vehicle's tank.  
Refuel the vehicle.
- The engine may be flooded.  
Try to restart the engine again following correct starting procedures.  
(→P. 192, 195)
- There may be a malfunction in the engine immobilizer system.  
(→P. 70)

### **The starter motor turns over slowly, the interior lights and headlights are dim, or the horn does not sound or sounds at a low volume.**

One of the following may be the cause of the problem:

- The battery may be discharged. (→P. 452)
- The battery terminal connections may be loose or corroded.

### **The starter motor does not turn over**

The engine starting system may be malfunctioning due to an electrical problem such as an open circuit or a blown fuse. However, an interim measure is available to start the engine.

(→P. 447)

**The starter motor does not turn over, the interior lights and headlights do not turn on, or the horn does not sound.**

One of the following may be the cause of the problem:

- One or both of the battery terminals may be disconnected.
- The battery may be discharged. (→P. 452)
- There may be a malfunction in the steering lock system (vehicles with a smart key system).

Contact your Toyota dealer if the problem cannot be repaired, or if repair procedures are unknown.

**Emergency start function (vehicles with a smart key system)**

When the engine does not start, the following steps can be used as an interim measure to start the engine if the engine switch is functioning normally:

- 1 Set the parking brake.
- 2 Shift the shift lever to P.
- 3 Turn the engine switch to ACCESSORY mode.
- 4 Press and hold the engine switch for about 15 seconds while depressing the brake pedal firmly.

Even if the engine can be started using the above steps, the system may be malfunctioning. Have the vehicle inspected by your Toyota dealer.

FarmaSOS.com

## If the shift lever cannot be shifted from P

**If the shift lever cannot be shifted with your foot on the brake pedal, there may be a problem with the shift lock system (a system to prevent accidental operation of the shift lever). Have the vehicle inspected by your Toyota dealer immediately.**

**The following steps may be used as an emergency measure to ensure that the shift lever can be shifted:**

- 1 Set the parking brake.
- 2 Vehicles without a smart key system:  
Turn the engine switch to the "ACC" position.  
Vehicles with a smart key system:  
Turn the engine switch to ACCESSORY mode.

- 3 Depress the brake pedal.

- 4 Pry the cover up with a flathead screwdriver or equivalent tool.

To prevent damage to the cover, cover the tip of the screwdriver with a rag.

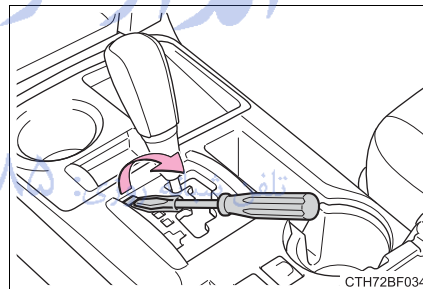

- 5 Press the shift lock override button.

The shift lever can be shifted while the button is pressed.

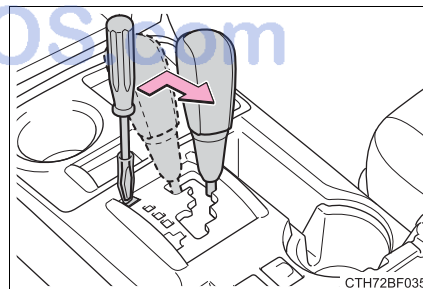

## If you cannot operate back door opener

If the back door opener does not operate, there may be a problem with the back door opener system. Have the vehicle inspected by your Toyota dealer immediately.

The following steps may be used as an emergency measure to ensure that the back door can be opened from the inside.

- 1 Remove the cover on the back door trim.

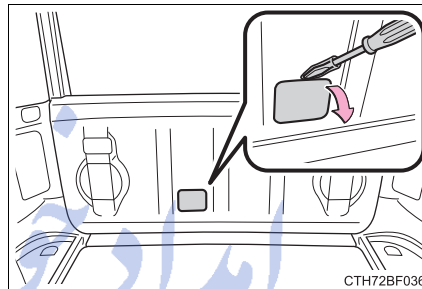

- 2 Tear the plastic film. Remove the cover.

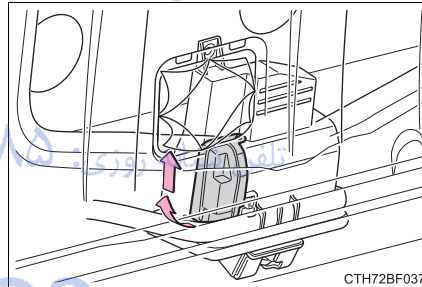

- 3 Pull the lever.

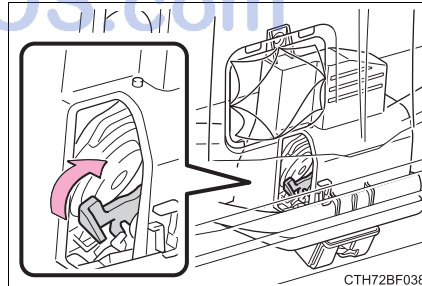

## If the electronic key does not operate properly (vehicles with a smart key system)

If communication between the electronic key and vehicle is interrupted (→P. 110) or the electronic key cannot be used because the battery is depleted, the smart key system and wireless remote control cannot be used. In such cases, the doors can be opened and the engine can be started by following the procedure below.

### Locking and unlocking the doors

Use the mechanical key (→P. 96) in order to perform the following operations:

- ① Locks all the doors
- ② Unlocks all the doors

Turning the key rearward unlocks the driver's door. Turning the key once again unlocks the other doors.

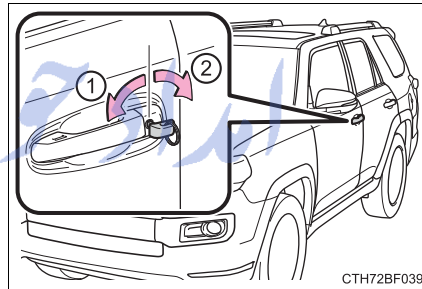

### Starting the engine

- 1 Ensure that the shift lever is in P and depress the brake pedal.
- 2 Touch the Toyota emblem side of the electronic key to the engine switch.

If any of the doors is opened or closed while the key is being touched to the switch, an alarm will sound to indicate that the start function cannot detect the key.

- 3 Press the engine switch.

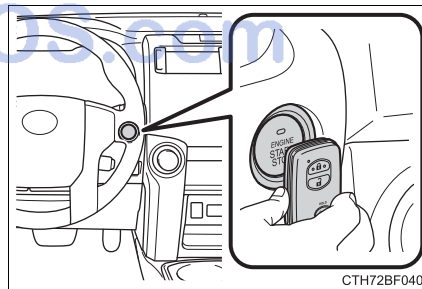

In the event that the engine still cannot be started, contact your Toyota dealer.



**■ Stopping the engine**

Shift the shift lever to P and press the engine switch as you normally do when stopping the engine.

**■ Replacing the key battery**

As the above procedure is a temporary measure, it is recommended that the electronic key battery be replaced immediately when the battery is depleted. (→P. 386)

**■ Changing engine switch modes**

Within 10 seconds of the buzzer sounding, release the brake pedal and press the engine switch.

The engine does not start and modes will be changed each time the switch is pressed.(→P. 196)

امداد خودرو فارما

تلفن شبانه روزی: ۰۲۱-۸۸۸۶۲۰۸۵

FarmaSOS.com

## If the vehicle battery is discharged

**The following procedures may be used to start the engine if the vehicle's battery is discharged.**

**You can also call your Toyota dealer or a qualified repair shop.**

If you have a set of jumper (or booster) cables and a second vehicle with a 12-volt battery, you can jump start your vehicle by following the steps below.

- 1 Open the hood (→P. 356)
- 2 Connect the jumper cables according to the following procedure:

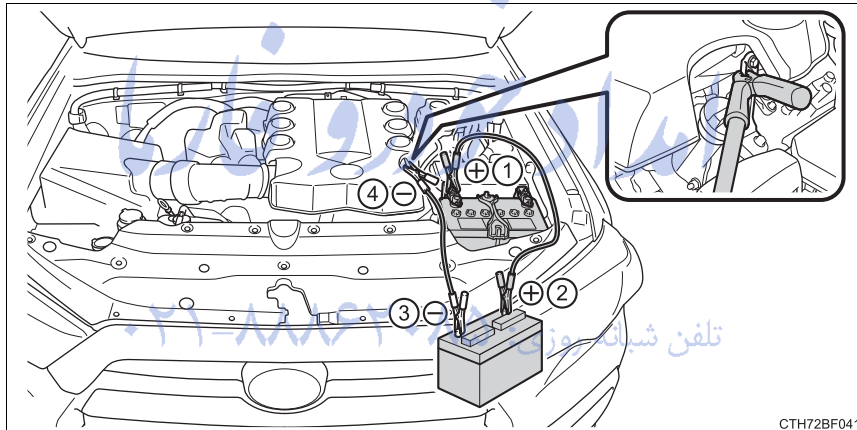

- ① Connect a positive jumper cable clamp to the positive (+) battery terminal on your vehicle.
  - ② Connect the clamp on the other end of the positive cable to the positive (+) battery terminal on the second vehicle.
  - ③ Connect a negative cable clamp to the negative (-) battery terminal on the second vehicle.
  - ④ Connect the clamp at the other end of the negative cable to a solid, stationary, unpainted metallic point away from the battery and any moving parts, as shown in the illustration.
- 3 Start the engine of the second vehicle. Increase the engine speed slightly and maintain at that level for approximately 5 minutes to recharge the battery of your vehicle.

- 4 Vehicles with a smart key system only: Open and close any of the doors of your vehicle with the engine switch off.
- 5 Maintain the engine speed of the second vehicle and start the engine of your vehicle by turning the engine switch to the "ON" position (vehicles without a smart key system) or turning the engine switch to IGNITION ON mode (vehicles with a smart key system).
- 6 Once the vehicle's engine has started, remove the jumper cables in the exact reverse order from which they were connected.

Once the engine starts, have the vehicle inspected at your Toyota dealer as soon as possible.

#### ■ Starting the engine when the battery is discharged

The engine cannot be started by push-starting.

#### ■ To prevent battery discharge

- Turn off the headlights and the audio system while the engine is off.
- Turn off any unnecessary electrical components when the vehicle is running at a low speed for an extended period, such as in heavy traffic.

#### ■ Charging the battery

The electricity stored in the battery will discharge gradually even when the vehicle is not in use, due to natural discharge and the draining effects of certain electrical appliances. If the vehicle is left for a long time, the battery may discharge, and the engine may be unable to start. (The battery recharges automatically during driving.)

#### ■ When recharging or replacing the battery

- Vehicles with a smart key system: In some cases, it may not be possible to unlock the doors using the smart key system when the battery is discharged. Use the wireless remote control or the mechanical key to lock or unlock the doors.
- The engine may not start on the first attempt after the battery has recharged but will start normally after the second attempt. This is not a malfunction.
- Vehicles with a smart key system: The engine switch mode is memorized by the vehicle. When the battery is reconnected, the system will return to the mode it was in before the battery was discharged. Before disconnecting the battery, turn the engine switch off.  
If you are unsure what mode the engine switch was in before the battery discharged, be especially careful when reconnecting the battery.
- Make sure that the key is not inside the vehicle when recharging or replacing the battery. The key may be locked in the vehicle if the alarm is activated. (→P. 73)

 CAUTION**■ Avoiding battery fires or explosions**

Observe the following precautions to prevent accidentally igniting the flammable gas that may be emitted from the battery:

- Make sure each jumper cable is connected to the correct terminal and that it is not unintentionally in contact with any other than the intended terminal.
- Do not allow the other end of the jumper cable connected to the “+” terminal to come into contact with any other parts or metal surfaces in the area, such as brackets or unpainted metal.
- Do not allow the + and - clamps of the jumper cables to come into contact with each other.
- Do not smoke, use matches, cigarette lighters or allow open flame near the battery.

**■ Battery precautions**

The battery contains poisonous and corrosive acidic electrolyte, while related parts contain lead and lead compounds. Observe the following precautions when handling the battery:

- When working with the battery, always wear safety glasses and take care not to allow any battery fluids (acid) to come into contact with skin, clothing or the vehicle body.
- Do not lean over the battery.
- In the event that battery fluid comes into contact with the skin or eyes, immediately wash the affected area with water and seek medical attention. Place a wet sponge or cloth over the affected area until medical attention can be received.
- Always wash your hands after handling the battery support, terminals, and other battery-related parts.
- Do not allow children near the battery.

 NOTICE**■ When handling jumper cables**

When connecting the jumper cables, ensure that they do not become entangled in the cooling fans or engine drive belt.

## If your vehicle overheats

### The following may indicate that your vehicle is overheating:

- The needle of the engine coolant temperature gauge (→P. 81) enters the red zone or a loss of engine power is experienced. (For example, the vehicle speed does not increase.)
- Steam comes out from under the hood.

### Correction procedures

- 1 Stop the vehicle in a safe place and turn off the air conditioning system, and then stop the engine.
- 2 If you see steam:  
Carefully lift the hood after the steam subsides.  
If you do not see steam:  
Carefully lift the hood.

- 3 After the engine has cooled down sufficiently, inspect the hoses and radiator core (radiator) for any leaks.

- 1 Radiator
- 2 Cooling fan

If a large amount of coolant leaks, immediately contact your Toyota dealer.

- 4 The coolant level is satisfactory if it is between the "F" and "L" lines on the reservoir.

- 1 Reservoir
- 2 "F" line
- 3 "L" line
- 4 Radiator cap

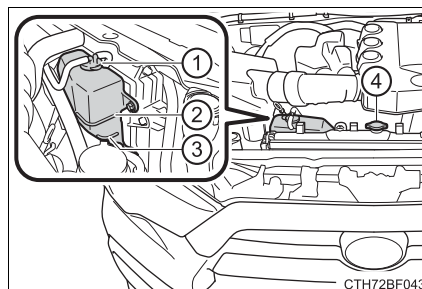
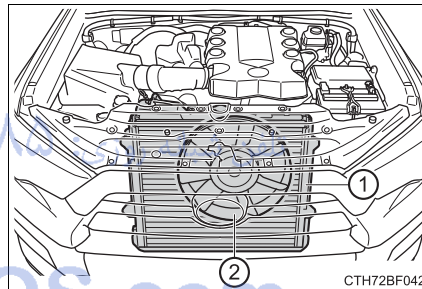

- 5 Add engine coolant if necessary. (→P. 358)

Water can be used in an emergency if engine coolant is unavailable.

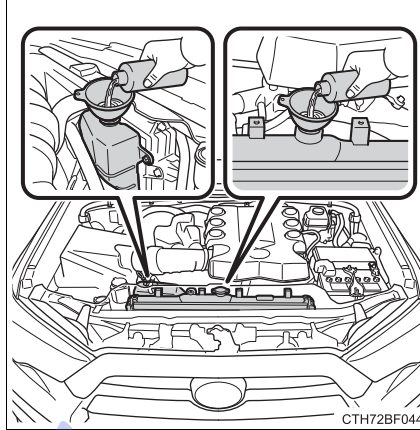

- 6 Start the engine and check that the radiator cooling fan operate and to check for coolant leaks from the radiator or hoses.
- 7 If the fan are not operating:  
Stop the engine immediately and contact your Toyota dealer.
- If the fan are operating:  
Have the vehicle inspected at the nearest Toyota dealer.

**CAUTION**

**When inspecting under the hood of your vehicle**

Observe the following precautions.

Failure to do so may result in serious injury such as burns.

- If steam is seen coming from under the hood, do not open the hood until the steam has subsided. The engine compartment may be very hot.
- Keep hands and clothing (especially a tie, a scarf or a muffler) away from the fans and belts.
- Do not loosen the radiator cap and the coolant reservoir cap while the engine and radiator are hot.  
High temperature steam or coolant could spray out.

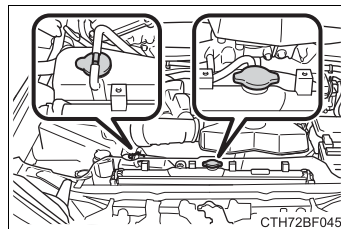

 NOTICE**■ When adding engine coolant**

Wait until the engine has cooled down before adding engine coolant. When adding coolant, do so slowly. Adding cool coolant to a hot engine too quickly can cause damage to the engine.

**■ To prevent damage to the cooling system**

Observe the following precautions:

- Avoid contaminating the coolant with foreign matter (such as sand or dust etc.).
- Do not use any coolant additives.

امداد خودرو فارما

تلفن شبانه روزی: ۰۲۱-۸۸۸۶۲۰۸۵

FarmaSOS.com

## If the vehicle becomes stuck

**Carry out the following procedures if the tires spin or the vehicle becomes stuck in mud, dirt or snow:**

- 1 Stop the engine. Set the parking brake and shift the shift lever to P.
- 2 Remove the mud, snow or sand from around the stuck tire.
- 3 Place wood, stones or some other material under the tires to help provide traction.
- 4 Restart the engine.
- 5 Shift the shift lever to D or R position and carefully apply the accelerator to free the vehicle.

Turn off TRAC and VSC if these functions are hampering your attempts to free the vehicle. (→P. 262)

### CAUTION

#### ■ When attempting to free a stuck vehicle

If you choose to push the vehicle back and forth to free it, make sure the surrounding area is clear to avoid striking other vehicles, objects or people. The vehicle may also lunge forward or lunge back suddenly as it becomes free. Use extreme caution.

#### ■ When shifting the shift lever

Be careful not to shift the shift lever with the accelerator pedal depressed. This may lead to unexpected rapid acceleration of the vehicle that may cause an accident resulting in death or serious injury.

### NOTICE

#### ■ To avoid damaging the transmission and other components

- Avoid spinning the wheels and depressing the accelerator pedal more than necessary.
- If the vehicle remains stuck even after these procedures are performed, the vehicle may require towing to be freed.



**Vehicle specifications****8****8-1. Specifications**

Maintenance data (fuel, oil level, etc.).....	460
Fuel information .....	470
Tire information .....	473

**8-2. Customization**

Customizable features .....	485
-----------------------------	-----

**8-3. Items to initialize**

Items to initialize .....	491
---------------------------	-----

امداد خودرو فارما

تلفن شبانه روزی: ۰۲۱-۸۸۸۶۲۰۸۵

FarmaSOS.com

## Maintenance data (fuel, oil level, etc.)

## Dimensions and weights

Overall length	189.8 in. (4820 mm)	
Overall width	75.8 in. (1925 mm)	
Overall height *1	70.1 in. (1780 mm)	
Wheelbase	109.8 in. (2790 mm)	
Tread	Front	63.2 in. (1605 mm)
	Rear	63.2 in. (1605 mm)
Vehicle capacity weight (Occupants + luggage)	1165 lb. (525 kg) *2	
	835 lb. (375 kg) *3	
Trailer weight rating (trailer weight + cargo weight)	5000 lb. (2270 kg)	
Luggage compartment load capacity	970 lb. (445 kg) *4	
	670 lb. (309 kg) *5	

\*1: Unladen vehicle

\*2: Without rear differential lock system

\*3: With rear differential lock system (TRAIL) تلفن شبانه روزی: ۰۲۱-۸۸۸۸۸۸۸۸

\*4: With 5 occupants

\*5: With 7 occupants

FarmaSOS.com

## Vehicle identification

### ■ Vehicle identification number

The vehicle identification number (VIN) is the legal identifier for your vehicle. This is the primary identification number for your Toyota. It is used in registering the ownership of your vehicle.

This number is stamped on the top left of the instrument panel.

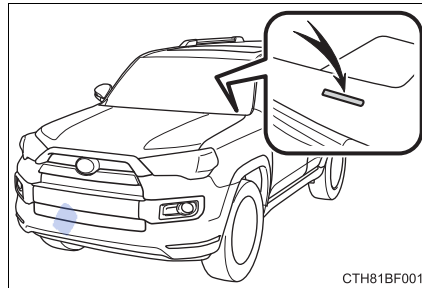

This number is also on the Certification Label.

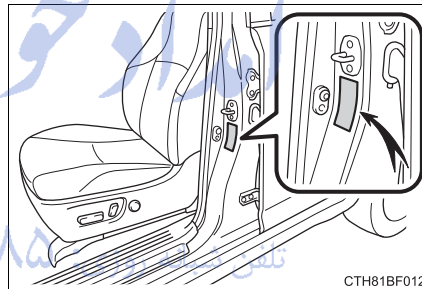

### ■ Engine number

The engine number is stamped on the engine block as shown.

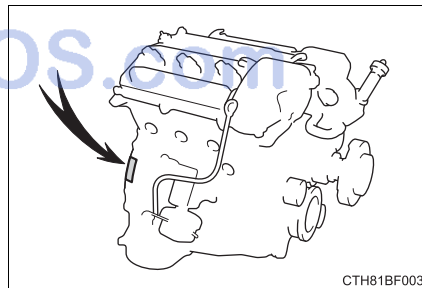

**Engine**

Model	1GR-FE
Type	6-cylinder V type, 4-cycle, gasoline
Bore and stroke	3.70 × 3.74 in. (94.0 × 95.0 mm)
Displacement	241.4 cu.in. (3956 cm <sup>3</sup> )
Valve clearance (engine cold)	Automatic adjustment
Drive belt tension	Automatic adjustment

**Fuel**

Fuel type	Unleaded gasoline only
Octane rating	87 (Research octane number 91) or higher
Fuel tank capacity (Reference)	23.0 gal. (87.0 L, 19.1 Imp. gal.)

تلفن شبانه روزی: ۰۲۱-۸۸۸۶۲۰۸۵

FarmaSOS.com

### Lubrication system

Oil capacity (Drain and refill — reference *)	
With filter	6.6 qt. (6.2 L, 5.5 Imp. qt.)
Without filter	6.0 qt. (5.7 L, 5.0 Imp. qt.)

\*: The engine oil capacity is a reference quantity to be used when changing the engine oil. Warm up and turn off the engine, wait more than 5 minutes, and check the oil level on the dipstick.

#### ■ Engine oil selection

“Toyota Genuine Motor Oil” is used in your Toyota vehicle. Use Toyota approved “Toyota Genuine Motor Oil” or equivalent to satisfy the following grade and viscosity.

Oil grade: ILSAC GF-5 multigrade engine oil

Recommended viscosity: SAE 0W-20

SAE 0W-20 is the best choice for good fuel economy and good starting in cold weather.

If SAE 0W-20 is not available, SAE 5W-20 oil may be used. However, it must be replaced with SAE 0W-20 at the next oil change.

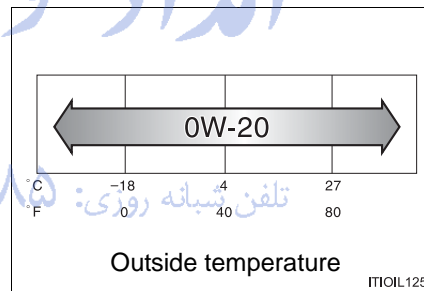

Oil viscosity (0W-20 is explained here as an example):

- The 0W in 0W-20 indicates the characteristic of the oil which allows cold startability. Oils with a lower value before the W allow for easier starting of the engine in cold weather.
- The 20 in 0W-20 indicates the viscosity characteristic of the oil when the oil is at high temperature. An oil with a higher viscosity (one with a higher value) may be better suited if the vehicle is operated at high speeds, or under extreme load conditions.

How to read oil container label:

The International Lubricant Specification Advisory Committee (ILSAC) Certification Mark is added to some oil containers to help you select the oil you should use.

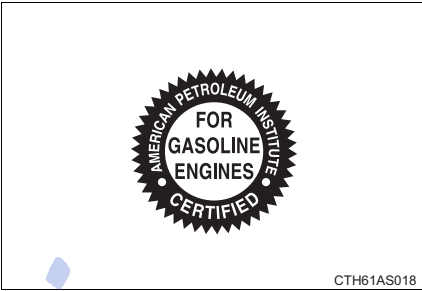

**Cooling system**

Capacity	11.1 qt. (10.5 L, 9.2 Imp. qt.)
Coolant type	Use either of the following: <ul style="list-style-type: none"> <li>• “Toyota Super Long Life Coolant”</li> <li>• A similar high-quality ethylene glycol-based non-silicate, non-amine, non-nitrite, and non-borate coolant with long-life hybrid organic acid technology.</li> </ul> Do not use plain water alone.

**Ignition system**

Spark plug	DENSO SK16HR11 0.043 in. (1.1 mm)
Make	
Gap	

NOTICE

**Iridium-tipped spark plugs**  
Use only iridium-tipped spark plugs. Do not adjust the spark plug gap.

**Electrical system**

Battery	12.6 — 12.8 V Fully charged 12.2 — 12.4 V Half charged 11.8 — 12.0 V Discharged (*: Voltage checked 20 minutes after the engine and all the lights are turned off.)
Open voltage* at 68°F (20°C):	
Charging rates	5 A max.

**Transfer (4WD models)**

Oil capacity	▶ Part-time 4WD models 1.1 qt. (1.0 L, 0.9 Imp. qt.) ▶ Full-time 4WD models 1.5 qt. (1.4 L, 1.2 Imp. qt.)
Oil type*	Toyota Genuine Transfer gear oil LF or equivalent
Recommended oil viscosity	SAE 75W

\*: Your Toyota vehicle is filled with "Toyota Genuine Transfer Gear oil LF" at the factory. Use Toyota approved "Toyota Genuine Transfer Gear oil LF" or an equivalent of matching quality to satisfy the above specification. Please contact your Toyota dealer for further details.

FarmaSOS.com

8

Vehicle specifications

**Front differential (4WD models)**

Oil capacity	<ul style="list-style-type: none"> <li>▶ Part-time 4WD models 1.6 qt. (1.55 L, 1.4 Imp. qt.)</li> <li>▶ Full-time 4WD models 1.5 qt. (1.40 L, 1.2 Imp. qt.)</li> </ul>
Oil type and viscosity*	Toyota Genuine Differential gear oil LT 75W-85 GL-5 or equivalent

\*: Your Toyota vehicle is filled with "Toyota Genuine Differential Gear Oil" at the factory. Use Toyota approved "Toyota Genuine Differential Gear Oil" or an equivalent of matching quality to satisfy the above specification. Please contact your Toyota dealer for further details.

**Rear differential**

Oil capacity	<ul style="list-style-type: none"> <li>▶ Vehicles without a rear differential lock 2.9 qt. (2.70 L, 2.4 Imp. qt.)</li> <li>▶ Vehicles with a rear differential lock 2.8 qt. (2.65 L, 2.3 Imp. qt.)</li> </ul>
Oil type and viscosity*	Toyota Genuine Differential gear oil LT 75W-85 GL-5 or equivalent

\*: Your Toyota vehicle is filled with "Toyota Genuine Differential Gear Oil" at the factory. Use Toyota approved "Toyota Genuine Differential Gear Oil" or an equivalent of matching quality to satisfy the above specification. Please contact your Toyota dealer for further details.

FarmaSOS.com



### Automatic transmission

Fluid capacity*	11.3 qt. (10.7 L, 9.4 Imp. qt.)
Fluid type	Toyota Genuine ATF WS

\*: The fluid capacity is a reference quantity. If replacement is necessary, contact your Toyota dealer.

#### NOTICE

#### ■ Transmission fluid type

Using transmission fluid other than “Toyota Genuine ATF WS” may cause deterioration in shift quality, locking up of the transmission accompanied by vibration and, ultimately, damage to the vehicle’s transmission.

### Brakes

Pedal clearance* <sup>1</sup>	3.62 in. (92 mm) Min.
Pedal free play	Less than 0.04 — 0.24 in. (1 — 6 mm)
Brake pad wear limit	0.04 in. (1.0 mm)
Parking brake lining wear limit	0.04 in. (1.0 mm)
Parking brake pedal travel* <sup>2</sup>	5 — 7 clicks
Fluid type	SAE J1703 or FMVSS No.116 DOT 3

\*<sup>1</sup>: Minimum pedal clearance when depressed with a force of 110 lbf (490 N, 50 kgf) while the engine is running.

\*<sup>2</sup>: Parking brake pedal travel when depressed with a force of 67 lbf (300 N, 30 kgf).

**Chassis lubrication**

Propeller shafts	Spider	Lithium base chassis grease, NLGI No.2
	Slide yoke	Molybdenum-disulfide lithium base chassis grease, NLGI No.2 or lithium base chassis grease, NLGI No.2

**Steering**

Free play	Less than 1.2 in. (30 mm)
Power steering fluid type	Automatic transmission fluid DEXRON® II or III

**Tires and wheels**

Tire size	P265/70R17 113S, P245/60R20 107H
Tire inflation pressure (Recommended cold tire inflation pressure)	Front: 32 psi (220 kPa, 2.2 kgf/cm <sup>2</sup> or bar) Rear: 32 psi (220 kPa, 2.2 kgf/cm <sup>2</sup> or bar) Spare: 32 psi (220 kPa, 2.2 kgf/cm <sup>2</sup> or bar)
Wheel size	17 × 7J, 17 × 7 1/2J, 20 × 7J
Wheel nut torque	81 ft•lbf (110 N•m, 11.2 kgf•m)

FarmaSOS.com

**Light bulbs**

	Light bulbs	Bulb No.	W	Type
Exterior	Headlights and daytime running lights			
	Low beam	—	55	A
	High beam	9005	60	B
	Front turn signal and parking lights	7444NA	28/8	E
	Front side marker lights	—	5	D
	Fog lights	—	19	C
	Rear turn signal lights	—	21	E
Interior	Back-up lights	—	16	D
	License plate lights	—	5	D
	Front personal/ front interior lights	—	5	D
	Rear interior light	—	8	F
	Vanity lights	—	8	D
	Door courtesy lights	168	5	D
	Luggage compartment lights	—	8	F

A: H11 halogen bulbs

D: Wedge base bulbs (clear)

B: HB3 halogen bulbs

E: Wedge base bulbs (amber)

C: H16 halogen bulbs

F: Double end bulbs

## Fuel information

**You must only use unleaded gasoline in your vehicle. Select octane rating 87 (Research Octane Number 91) or higher. Use of unleaded gasoline with an octane rating lower than 87 may result in engine knocking. Persistent knocking can lead to engine damage.**

At minimum, the gasoline you use should meet the specifications of ASTM D4814 in the U.S.A. and CGSB3.5-M93 in Canada.

---

### ■ Fuel tank opening for unleaded gasoline

To help prevent incorrect fueling, your vehicle has a fuel tank opening that only accommodates the special nozzle on unleaded fuel pumps.

### ■ Gasoline quality

In very few cases, driveability problems may be caused by the brand of gasoline you are using. If driveability problems persist, try changing the brand of gasoline. If this does not correct the problem, consult your Toyota dealer.

### ■ Gasoline quality standards

- Automotive manufacturers in the U.S.A., Europe and Japan have developed a specification for fuel quality called the World-Wide Fuel Charter (WWFC), which is expected to be applied worldwide.
- The WWFC consists of four categories that are based on required emission levels. In the U.S., category 4 has been adopted.
- The WWFC improves air quality by lowering emissions in vehicle fleets, and improves customer satisfaction through better performance.

FarmaSOS.com

### ■ Recommendation of the use of gasoline containing detergent additives

- Toyota recommends the use of gasoline that contains detergent additives to avoid the build-up of engine deposits.
- All gasoline sold in the U.S.A. contains minimum detergent additives to clean and/or keep clean intake systems, per EPA's lowest additives concentration program.
- Toyota strongly recommends the use of Top Tier Detergent Gasoline. For more information on Top Tier Detergent Gasoline and a list of marketers, please go to the official website [www.toptiergas.com](http://www.toptiergas.com).

### ■ Recommendation of the use of cleaner burning gasoline

Cleaner burning gasoline, including reformulated gasoline that contains oxygenates such as ethanol or MTBE (Methyl Tertiary Butyl Ether) is available in many areas.

Toyota recommends the use of cleaner burning gasoline and appropriately blended reformulated gasoline. These types of gasoline provide excellent vehicle performance, reduce vehicle emissions and improve air quality.

### ■ Non-recommendation of the use of blended gasoline

- Use only gasoline containing a maximum of 10% ethanol. DO NOT use any flex-fuel or gasoline that could contain more than 10% ethanol, including from any pump labeled E15, E30, E50, E85 (which are only some examples of fuel containing more than 10% ethanol).

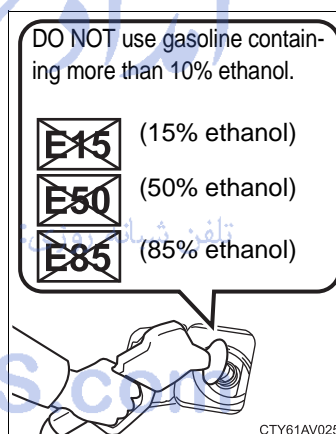

- If you use gasohol in your vehicle, be sure that it has an octane rating no lower than 87.
- Toyota does not recommend the use of gasoline containing methanol.

#### ■ Non-recommendation of the use of gasoline containing MMT

Some gasoline contains an octane enhancing additive called MMT (Methylcyclopentadienyl Manganese Tricarbonyl).

Toyota does not recommend the use of gasoline that contains MMT. If fuel containing MMT is used, your emission control system may be adversely affected.

The malfunction indicator lamp on the instrument cluster may come on. If this happens, contact your Toyota dealer for service.

#### ■ If your engine knocks

- Consult your Toyota dealer.
- You may occasionally notice light knocking for a short time while accelerating or driving uphill. This is normal and there is no need for concern.

#### NOTICE

##### ■ Notice on fuel quality

- Do not use improper fuels. If improper fuels are used, the engine will be damaged.
- Do not use leaded gasoline.  
Leaded gasoline can cause damage to your vehicle's three-way catalytic converters causing the emission control system to malfunction.
- Do not use gasohol other than the type previously stated.  
Other gasohol may cause fuel system damage or vehicle performance problems.
- Using unleaded gasoline with an octane number or rating lower than the level previously stated will cause persistent heavy knocking.  
At worst, this will lead to engine damage.

##### ■ Fuel-related poor driveability

If poor driveability is encountered after using a different type of fuel (poor hot starting, vaporization, engine knocking, etc.), discontinue the use of that type of fuel.

##### ■ When refueling with gasohol

Take care not to spill gasohol. It can damage your vehicle's paint.

## Tire information

### Typical tire symbols

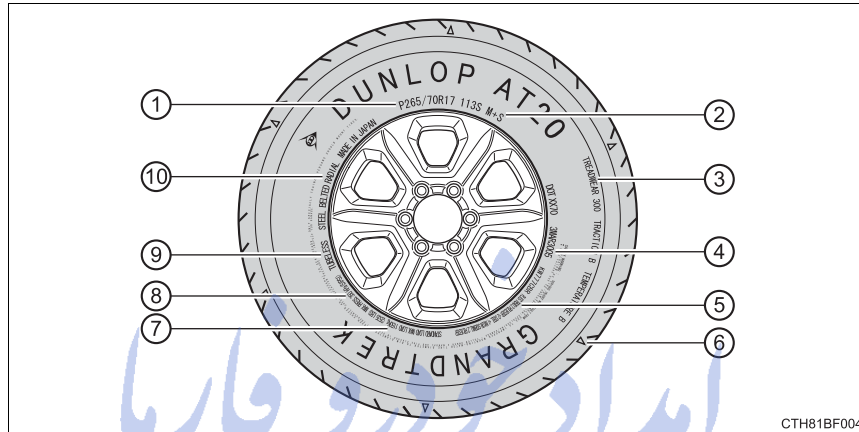

- ① Tire size (→P. 475)
- ② Summer tires or all season tires (→P. 374)  
An all season tire has “M+S” on the sidewall. A tire not marked “M+S” is a summer tire.
- ③ Uniform tire quality grading  
For details, see “Uniform Tire Quality Grading” that follows.
- ④ DOT and Tire Identification Number (TIN)(→P. 474)
- ⑤ Tire ply composition and materials  
Plies are layers of rubber-coated parallel cords. Cords are the strands which form the plies in a tire.
- ⑥ Location of treadwear indicators(→P. 372)

- ⑦ Load limit at maximum cold tire inflation pressure (→P. 479)
- ⑧ Maximum cold tire inflation pressure (→P. 479)  
This means the pressure to which a tire may be inflated.
- ⑨ TUBELESS or TUBE TYPE  
A tubeless tire does not have a tube and air is directly put into the tire.  
A tube type tire has a tube inside the tire and the tube maintains the air pressure.
- ⑩ Radial tires or bias-ply tires  
A radial tire has "RADIAL" on the sidewall. A tire not marked "RADIAL" is a bias-ply tire.

#### Typical DOT and Tire Identification Number (TIN)

- ① DOT symbol\*
- ② Tire Identification Number (TIN)
- ③ Tire manufacturer's identification mark
- ④ Tire size code
- ⑤ Manufacturer's optional tire type code (3 or 4 letters)
- ⑥ Manufacturing week
- ⑦ Manufacturing year

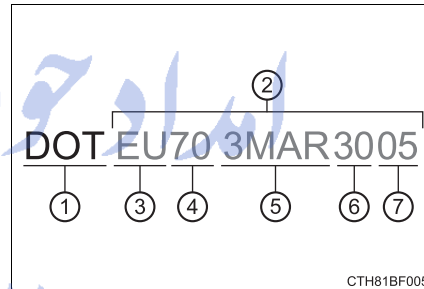

\*: The DOT symbol certifies that the tire conforms to applicable Federal Motor Vehicle Safety Standards.

FarmaSOS.com



## Tire size

### ■ Typical tire size information

The illustration indicates typical tire size.

- ① Tire use (P = Passenger car, T = Temporary use)
- ② Section width (millimeters)
- ③ Aspect ratio (tire height to section width)
- ④ Tire construction code (R = Radial, D = Diagonal)
- ⑤ Wheel diameter (inches)
- ⑥ Load index (2 digits or 3 digits)
- ⑦ Speed symbol (alphabet with one letter)

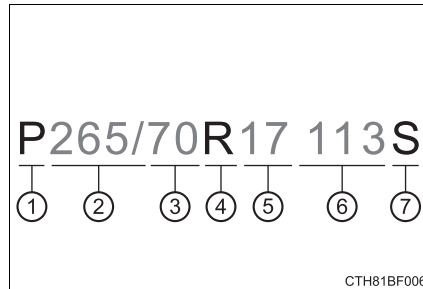

### ■ Tire dimensions

- ① Section width
- ② Tire height
- ③ Wheel diameter

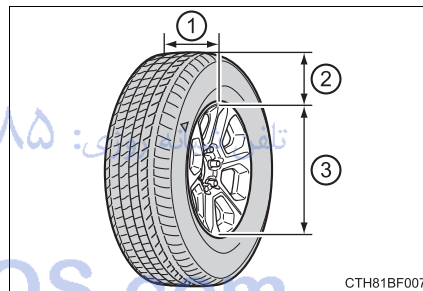

### Tire section names

- ① Bead
- ② Sidewall
- ③ Shoulder
- ④ Tread
- ⑤ Belt
- ⑥ Inner liner
- ⑦ Reinforcing rubber
- ⑧ Carcass
- ⑨ Rim lines
- ⑩ Bead wires
- ⑪ Chafer

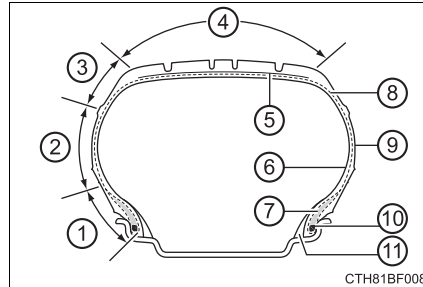

امداد خودرو فارما

تلفن شبانه روزی: ۰۲۱-۸۸۸۶۲۰۸۵

FarmaSOS.com

### Uniform Tire Quality Grading

This information has been prepared in accordance with regulations issued by the National Highway Traffic Safety Administration of the U.S. Department of Transportation.

It provides the purchasers and/or prospective purchasers of Toyota vehicles with information on uniform tire quality grading.

Your Toyota dealer will help answer any questions you may have as you read this information.

#### ■ DOT quality grades

All passenger vehicle tires must conform to Federal Safety Requirements in addition to these grades. Quality grades can be found where applicable on the tire sidewall between tread shoulder and maximum section width.

For example: Treadwear 200 Traction AA Temperature A

#### ■ Treadwear

The treadwear grade is a comparative rating based on the wear rate of the tire when tested under controlled conditions on a specified government test course.

For example, a tire graded 150 would wear one and a half (1 - 1/2) times as well on the government course as a tire graded 100.

The relative performance of tires depends upon the actual conditions of their use. Performance may differ significantly from the norm due to variations in driving habits, service practices and differences in road characteristics and climate.

#### ■ Traction AA, A, B, C

The traction grades, from highest to lowest, are AA, A, B and C, and they represent the tire's ability to stop on wet pavement as measured under controlled conditions on specified government test surfaces of asphalt and concrete.

A tire marked C may have poor traction performance.

Warning: The traction grade assigned to this tire is based on braking (straight ahead) traction tests and does not include cornering (turning) traction.

■ **Temperature A, B, C**

The temperature grades are A (the highest), B, and C, representing the tire's resistance to the generation of heat and its ability to dissipate heat when tested under controlled conditions on a specified indoor laboratory test wheel.

Sustained high temperature can cause the material of the tire to degenerate and reduce tire life, and excessive temperature can lead to sudden tire failure.

Grade C corresponds to a level of performance which all passenger car tires must meet under the Federal Motor Vehicle Safety Standard No. 109.

Grades B and A represent higher levels of performance on the laboratory test wheel than the minimum required by law.

Warning: The temperature grades of a tire assume that it is properly inflated and not overloaded.

Excessive speed, underinflation, or excessive loading, either separately or in combination, can cause heat buildup and possible tire failure.

تلفن شبانه روزی: ۰۲۱-۸۸۸۶۲۰۸۵

FarmaSOS.com

**Glossary of tire terminology**

Tire related term	Meaning
Cold tire inflation pressure	Tire pressure when the vehicle has been parked for three hours or more, or has not been driven more than 1 mile or 1.5 km under that condition
Maximum inflation pressure	The maximum cold inflated pressure to which a tire may be inflated, shown on the sidewall of the tire
Recommended inflation pressure	Cold tire inflation pressure recommended by a manufacturer
Accessory weight	The combined weight (in excess of those standard items which may be replaced) of automatic transmission, power steering, power brakes, power windows, power seats, radio and heater, to the extent that these items are available as factory-installed equipment (whether installed or not)
Curb weight	The weight of a motor vehicle with standard equipment, including the maximum capacity of fuel, oil and coolant, and if so equipped, air conditioning and additional weight optional engine
Maximum loaded vehicle weight	The sum of: (a) Curb weight (b) Accessory weight (c) Vehicle capacity weight (d) Production options weight
Normal occupant weight	150 lb. (68 kg) times the number of occupants specified in the second column of Table 1* that follows
Occupant distribution	Distribution of occupants in a vehicle as specified in the third column of Table 1* below

Tire related term	Meaning
Production options weight	The combined weight of installed regular production options weighing over 5 lb. (2.3 kg) in excess of the standard items which they replace, not previously considered in curb weight or accessory weight, including heavy duty brakes, ride levelers, roof rack, heavy duty battery, and special trim
Rim	A metal support for a tire or a tire and tube assembly upon which the tire beads are seated
Rim diameter (Wheel diameter)	Nominal diameter of the bead seat
Rim size designation	Rim diameter and width
Rim type designation	The industry manufacturer's designation for a rim by style or code
Rim width	Nominal distance between rim flanges
Vehicle capacity weight (Total load capacity)	The rated cargo and luggage load plus 150 lb. (68 kg) times the vehicle's designated seating capacity
Vehicle maximum load on the tire	The load on an individual tire that is determined by distributing to each axle its share of the maximum loaded vehicle weight, and dividing by two
Vehicle normal load on the tire	The load on an individual tire that is determined by distributing to each axle its share of curb weight, accessory weight, and normal occupant weight (distributed in accordance with Table 1* below), and dividing by two
Weather side	The surface area of the rim not covered by the inflated tire
Bead	The part of the tire that is made of steel wires, wrapped or reinforced by ply cords and that is shaped to fit the rim
Bead separation	A breakdown of the bond between components in the bead

Tire related term	Meaning
Bias ply tire	A pneumatic tire in which the ply cords that extend to the beads are laid at alternate angles substantially less than 90 degrees to the centerline of the tread
Carcass	The tire structure, except tread and sidewall rubber which, when inflated, bears the load
Chunking	The breaking away of pieces of the tread or sidewall
Cord	The strands forming the plies in the tire
Cord separation	The parting of cords from adjacent rubber compounds
Cracking	Any parting within the tread, sidewall, or innerliner of the tire extending to cord material
CT	A pneumatic tire with an inverted flange tire and rim system in which the rim is designed with rim flanges pointed radially inward and the tire is designed to fit on the underside of the rim in a manner that encloses the rim flanges inside the air cavity of the tire
Extra load tire	A tire designed to operate at higher loads and at higher inflation pressures than the corresponding standard tire
Groove	The space between two adjacent tread ribs
Innerliner	The layer(s) forming the inside surface of a tubeless tire that contains the inflating medium within the tire
Innerliner separation	The parting of the innerliner from cord material in the carcass
Intended outboard sidewall	(a) The sidewall that contains a whitewall, bears white lettering, or bears manufacturer, brand, and/or model name molding that is higher or deeper than the same molding on the other sidewall of the tire, or (b) The outward facing sidewall of an asymmetrical tire that has a particular side that must always face outward when mounted on a vehicle

Tire related term	Meaning
Light truck (LT) tire	A tire designated by its manufacturer as primarily intended for use on lightweight trucks or multipurpose passenger vehicles
Load rating	The maximum load that a tire is rated to carry for a given inflation pressure
Maximum load rating	The load rating for a tire at the maximum permissible inflation pressure for that tire
Maximum permissible inflation pressure	The maximum cold inflation pressure to which a tire may be inflated
Measuring rim	The rim on which a tire is fitted for physical dimension requirements
Open splice	Any parting at any junction of tread, sidewall, or innerliner that extends to cord material
Outer diameter	The overall diameter of an inflated new tire
Overall width	The linear distance between the exteriors of the sidewalls of an inflated tire, including elevations due to labeling, decorations, or protective bands or ribs
Passenger car tire	A tire intended for use on passenger cars, multipurpose passenger vehicles, and trucks, that have a gross vehicle weight rating (GVWR) of 10,000 lb. or less.
Ply	A layer of rubber-coated parallel cords
Ply separation	A parting of rubber compound between adjacent plies
Pneumatic tire	A mechanical device made of rubber, chemicals, fabric and steel or other materials, that, when mounted on an automotive wheel, provides the traction and contains the gas or fluid that sustains the load
Radial ply tire	A pneumatic tire in which the ply cords that extend to the beads are laid at substantially 90 degrees to the centerline of the tread
Reinforced tire	A tire designed to operate at higher loads and at higher inflation pressures than the corresponding standard tire



Tire related term	Meaning
Section width	The linear distance between the exteriors of the sidewalls of an inflated tire, excluding elevations due to labeling, decoration, or protective bands
Sidewall	That portion of a tire between the tread and bead
Sidewall separation	The parting of the rubber compound from the cord material in the sidewall
Snow tire	A tire that attains a traction index equal to or greater than 110, compared to the ASTM E-1136 Standard Reference Test Tire, when using the snow traction test as described in ASTM F-1805-00, Standard Test Method for Single Wheel Driving Traction in a Straight Line on Snow and Ice-Covered Surfaces, and which is marked with an Alpine Symbol (  ) on at least one sidewall
Test rim	The rim on which a tire is fitted for testing, and may be any rim listed as appropriate for use with that tire
Tread	That portion of a tire that comes into contact with the road
Tread rib	A tread section running circumferentially around a tire
Tread separation	Pulling away of the tread from the tire carcass
Treadwear indicators (TWI)	The projections within the principal grooves designed to give a visual indication of the degrees of wear of the tread
Wheel-holding fixture	The fixture used to hold the wheel and tire assembly securely during testing

\*: Table 1 — Occupant loading and distribution for vehicle normal load for various designated seating capacities

Designated seating capacity, Number of occupants	Vehicle normal load, Number of occupants	Occupant distribution in a normally loaded vehicle
2 through 4	2	2 in front
5 through 10	3	2 in front, 1 in second seat
11 through 15	5	2 in front, 1 in second seat, 1 in third seat, 1 in fourth seat
16 through 20	7	2 in front, 2 in second seat, 2 in third seat, 1 in fourth seat

امداد خودرو فارما

تلفن شبانه روزی: ۰۲۱-۸۸۸۶۲۰۸۵

FarmaSOS.com

## Customizable features

**Your vehicle includes a variety of electronic features that can be personalized to suit your preferences. Programming these preferences requires specialized equipment and may be performed by your Toyota dealer.**

Some function settings are changed simultaneously with other functions being customized. Contact your Toyota dealer for further details.

### ■ Smart key system and wireless remote control (→P. 100, 107)

Function	Default setting	Customized setting
Operation signal (Emergency flashers)	On	Off
Operation signal (Buzzer)	On	Off
Open door warning function (when locking the vehicle)	On	Off
Automatic door locking function (if a door is not opened after being unlocked)	On	Off
Time elapsed before automatic door lock function is activated if door is not opened after being unlocked	60 seconds	30 seconds
		120 seconds

### ■ Smart key system (→P. 107)

Function	Default setting	Customized setting
Smart key system	On	Off

■ **Wireless remote control (→P. 100)**

Function	Default setting	Customized setting
Wireless remote control	On	Off
Panic function	On	Off
Operation signal (Buzzer volume)	Level 7	OFF to level 6

■ **Door lock (→P. 100, 450)**

Function	Default setting	Customized setting
Speed-detecting automatic door lock function	Off	On
Shifting the shift lever to position other than P locks all doors	On	Off
Shifting the shift lever to P unlocks all doors	On	Off
Opening driver's door unlocks all doors	Off	On

■ **Power windows (→P. 148)** تلفن شبانه روزی: ۰۸۵۰۲۰۱۱۵۲

Function	Default setting	Customized setting
Mechanical key linked operation (close)	Off	On
Mechanical key linked operation (open)	Off	On
Wireless remote control linked operation (open)	Off	On
Wireless remote control linked operation signal (Buzzer)	On	Off

### ■ Automatic light control system (→P. 205)

Function	Default setting	Customized setting
Light sensor sensitivity	Level 3	Levels 1 to 5
Time elapsed before headlights automatically turn off after doors are closed	30 seconds	Off
		60 seconds
		90 seconds
Ambient light level at which instrument illumination begins to dim (meter lights etc.)	Standard	-2 (darker) to 2 (brighter)
Ambient light level at which instrument illumination begins to brighten (meter lights etc.)	Standard	-2 (darker) to 2 (brighter)

### ■ Illumination (→P. 295)

Function	Default setting	Customized setting
Time period before lights turn off	15 seconds	7.5 seconds
		30 seconds
Vehicles without a smart key system: Operation after the engine switch is turned to the "LOCK" position Vehicles with a smart key system: Operation after the engine switch is turned OFF	On	Off
Operation when the doors are unlocked	On	Off
Vehicles with a smart key system: Operation when you approach the vehicle with the electronic key on your person (When the interior light switch [ON/DOOR/OFF] is DOOR)	On	Off
Footwell lights	On	Off
Interior light control	On	Off
Interior light dimmer control while driving	On	Off

### ■ Outer foot lights (if equipped) (→P. 295)

Function	Default setting	Customized setting
Vehicles with a smart key system: Operation when you approach the vehicle with the electronic key on your person	On	Off
Operation when the doors are unlocked using the wireless remote control, key or entry function	On	Off
Operation when the doors are unlocked using the door lock switch	On	Off
Time period before lights turn off	15 seconds	7.5 seconds
		30 seconds
Lighting control	On	Off

### ■ Moon roof (→P. 155)

Function	Default setting	Customized setting
Mechanical key linked operation	Off	On
Mechanical key linked operation	Open and close	Open only
		Close only
Linked operation of components when door key is used	Slide only	Tilt only
Wireless remote control linked operation (open only)	Off	On
Linked operation of components when wireless remote control is used (open only)	Slide only	Tilt only

### ■ Rear window wiper and washer (→P. 216)

Function	Default setting	Customized setting
Wiper operates automatically when washer is operated	On	Off
Drip prevention function	On	Off
Wiper operation interval	3 seconds	2 seconds
		4 seconds
		5 seconds
Time elapsed before the rear wiper storage function activates	3 seconds	4 seconds
		5 seconds
		6 seconds

### ■ Power back window (→P. 151)

Function	Default setting	Customized setting
Vehicles without a smart key system: Close operation linked to door lock operation using a key	On	Off
Vehicles without a smart key system: Open operation linked to door unlock operation using a key	On	Off
Vehicles with a smart key system: Close operation linked to door lock operation using the switch	On	Off
Vehicles with a smart key system: Open operation linked to door unlock operation using the switch	On	Off
Vehicles with a smart key system: Time required to press and hold the switch before the window begins to open/close	0.8 seconds	1 second
		1.2 seconds
		1.4 seconds

■ **Intuitive parking assist (→P. 226)**

Function	Default setting	Customized setting
Buzzer volume	Max.	Min. to Max.

■ **Driving position memory (→P. 135)**

Function	Default setting	Customized setting
Selecting the door linking driving position memory with door unlock operation	Driver's door	All doors

■ **Seat belt reminder (→P. 421)**

Function	Default setting	Customized setting
Vehicle speed linked seat belt reminder buzzer	On	Off

تلفن شبانه روزی: ۰۲۱-۸۸۸۶۲۰۸۵

FarmaSOS.com



## Items to initialize

The following item must be initialized for normal system operation after such cases as the battery being reconnected, or maintenance being performed on the vehicle:

Item	When to initialize	Reference
Maintenance data	After the maintenance is performed	P. 348

امداد خودرو فارما

تلفن شبانه روزی: ۰۲۱-۸۸۸۶۲۰۸۵

FarmaSOS.com

امداد خودرو فارما

تلفن شبانه روزی: ۰۲۱-۸۸۸۶۲۰۸۵

**FarmaSOS.com**

Reporting safety defects for U.S. owners .....	494
Seat belt instructions for Canadian owners (in French) .....	495
SRS airbag instructions for Canadian owners (in French) .....	497

امداد خودرو فارما

تلفن شبانه روزی: ۰۲۱-۸۸۸۶۲۰۸۵

FarmaSOS.com

## Reporting safety defects for U.S. owners

If you believe that your vehicle has a defect which could cause a crash or could cause injury or death, you should immediately inform the National Highway Traffic Safety Administration (NHTSA) in addition to notifying Toyota Motor Sales, U.S.A., Inc. (Toll-free: 1-800-331-4331).

If NHTSA receives similar complaints, it may open an investigation, and if it finds that a safety defect exists in a group of vehicles, it may order a recall and remedy campaign. However, NHTSA cannot become involved in individual problems between you, your dealer, or Toyota Motor Sales, U.S.A., Inc.

To contact NHTSA, you may call the Vehicle Safety Hotline toll-free at 1-888-327-4236 (TTY: 1-800-424-9153); go to <http://www.safercar.gov>; or write to: Administrator, NHTSA, 1200 New Jersey Ave, S.E., Washington, DC 20590. You can also obtain other information about motor vehicle safety from <http://www.safercar.gov>.

تلفن شبانه روزی: ۰۲۱-۸۸۸۶۲۰۸۵

FarmaSOS.com

## Seat belt instructions for Canadian owners (in French)

The following is a French explanation of seat belt instructions extracted from the seat belt section in this manual.

See the seat belt section for more detailed seat belt instructions in English.

### Utilisation correcte des ceintures de sécurité

- Déroulez la sangle diagonale de telle sorte qu'elle passe bien sur l'épaule, sans pour autant être en contact avec le cou ou glisser de l'épaule.
- Placez la sangle abdominale le plus bas possible sur les hanches.
- Réglez la position du dossier de siège. Asseyez-vous le dos le plus droit possible et calez-vous bien dans le siège.
- Ne vrillez pas la ceinture de sécurité.

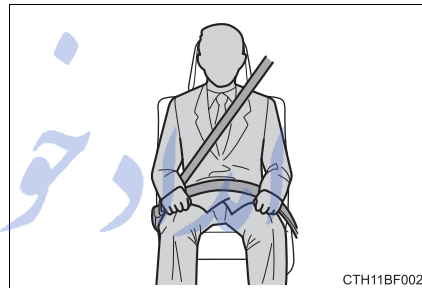

CTH11BF002

### Entretien et soin

#### ■ Ceintures de sécurité

Nettoyez avec un chiffon ou une éponge humectée d'eau savonneuse tiède. Vérifiez régulièrement que les ceintures ne sont pas effilochées, entaillées ou exagérément usées.

9

For owners

 CAUTION**■ Détérioration et usure des ceintures de sécurité**

Inspectez les ceintures de sécurité périodiquement. Contrôlez qu'elles ne sont pas entaillées, effilochées et que leurs ancrages ne sont pas desserrés. N'utilisez pas une ceinture de sécurité défectueuse avant qu'elle ne soit remplacée. Une ceinture de sécurité défectueuse n'apporte aucune garantie de protection de l'occupant en cas d'accident.

امداد خودرو فارما

تلفن شبانه روزی: ۰۲۱-۸۸۸۶۲۰۸۵

FarmaSOS.com

## SRS airbag instructions for Canadian owners (in French)

The following is a French explanation of SRS airbag instructions extracted from the SRS airbag section in this manual.

See the SRS airbag section for more detailed SRS airbag instructions in English.

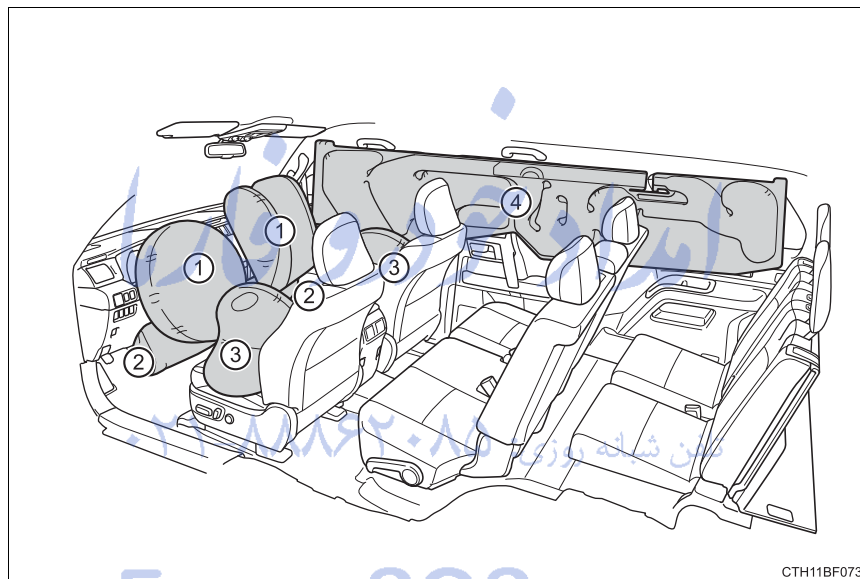

CTH11BF073

### ◆ Coussins gonflables avant SRS

- ① Coussin gonflable conducteur SRS/coussin gonflable passager avant  
Participant à la protection de la tête et du thorax du conducteur et du passager avant contre les chocs avec les éléments intérieurs
- ② Coussins gonflables de genoux SRS  
Participant à la protection du conducteur et du passager avant

---

**◆ Coussins gonflables latéraux et rideaux SRS**

---

- ③ Coussins gonflables latéraux SRS  
Participent à la protection du torse des passagers du siège avant
- ④ Coussins gonflables rideaux SRS
  - Participent principalement à la protection de la tête des occupants assis aux places extérieures
  - Empêche les occupants d'être éjectés du véhicule en cas de retournement du véhicule

امداد خودرو فارما

تلفن شبانه روزی: ۰۲۱-۸۸۸۶۲۰۸۵

FarmaSOS.com



### Composition du système de coussins gonflables SRS

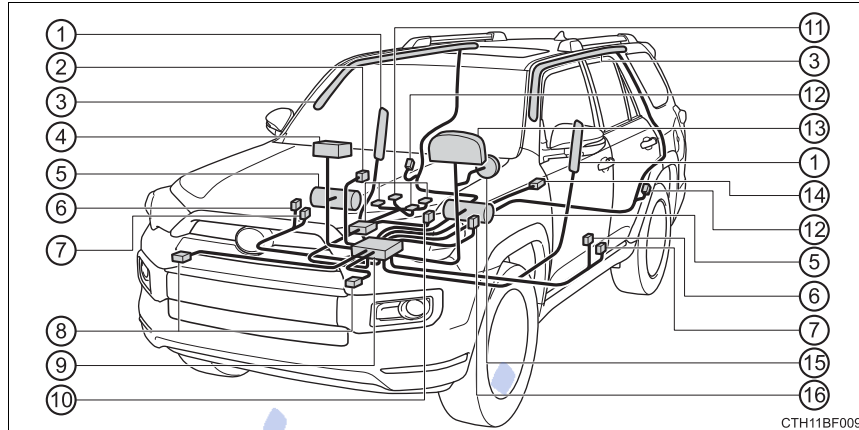

- |   |   |
|---|---|
| ① Coussins gonflables latéraux                                    | ⑩ Commutateur de boucle de ceinture de sécurité du siège du passager avant          |
| ② Témoins indicateurs "AIR BAG ON" et "AIR BAG OFF"               | ⑪ Système de classification de l'occupant du siège passager avant (ECU et capteurs) |
| ③ Coussins gonflables rideaux                                     | ⑫ Capteurs d'impact latéral (arrière)   |
| ④ Coussin gonflable passager avant                                | ⑬ Témoin d'avertissement SRS  |
| ⑤ Coussins gonflables de genoux                                   | ⑭ Capteur de protection (arrière)   |
| ⑥ Capteurs d'impact latéral (porte avant)                         | ⑮ Coussin gonflable conducteur  |
| ⑦ Pré-tensionneurs de ceintures de sécurité et limiteurs de force | ⑯ Commutateur de boucle de ceinture de sécurité du conducteur                       |
| ⑧ Capteurs d'impact avant   |   |
| ⑨ Capteur de coussin gonflable                                    |   |

Votre véhicule est équipé de COUSSINS GONFLABLES INTELLIGENTS conçus selon les normes de sécurité américaines applicables aux véhicules à moteur (FMVSS208). Le boîtier électronique (ECU) des coussins gonflables régule le déploiement de ces derniers sur la base des informations qu'il reçoit des capteurs, etc., indiqués ci-dessus dans le schéma illustrant les composants du système. Parmi ces informations figurent la gravité du choc et l'occupation du véhicule par les passagers. Le déploiement rapide des coussins gonflables est obtenu au moyen d'une réaction chimique dans les dispositifs pyrotechniques, qui produit un gaz inoffensif permettant d'amortir le mouvement des occupants.

امداد خودرو فارما

تلفن شبانه روزی: ۰۲۱-۸۸۸۶۲۰۸۵

FarmaSOS.com

 CAUTION

■ **Précautions avec le coussin gonflable SRS**

Respectez les précautions suivantes avec les coussins gonflables SRS. Autrement, des blessures graves, voire mortelles, pourraient s'ensuivre.

- Le conducteur et les passagers du véhicule doivent porter correctement leur ceinture de sécurité.

Les coussins gonflables SRS sont des dispositifs supplémentaires à utiliser avec les ceintures de sécurité.

- Le coussin gonflable conducteur SRS se déploie avec une violence considérable, qui peut être très dangereuse, voire mortelle, si le conducteur se trouve très près du coussin gonflable. L'autorité fédérale chargée de la sécurité routière aux États-Unis (NHTSA) conseille:

Sachant que la zone de danger pour le coussin gonflable conducteur se trouve dans les premiers 2 à 3 in. (50 - 75 mm) de déploiement, vous placer à 10 in. (250 mm) de votre coussin gonflable conducteur vous garantit une marge de sécurité suffisante. Cette distance est à mesurer entre l'axe du volant et le sternum. Si vous êtes assis à moins de 10 in. (250 mm), vous pouvez changer votre position de conduite de plusieurs façons:

- Reculez votre siège le plus possible, de manière à pouvoir encore atteindre confortablement les pédales.
- Inclinez légèrement le dossier du siège.  
Bien que les véhicules puissent être différents les uns des autres, la plupart des conducteurs peuvent s'asseoir à une distance de 10 in. (250 mm), même avec le siège conducteur complètement avancé, simplement en inclinant un peu le dossier de siège. Si vous avez des difficultés à voir la route après avoir incliné votre siège, utilisez un coussin ferme et antidérapant pour vous rehausser ou, si votre véhicule est équipé du réglage en hauteur du siège, remontez-le.
- Si votre volant est réglable, inclinez-le vers le bas. Cela a pour effet d'orienter le coussin gonflable en direction de votre poitrine plutôt que de votre tête et de votre cou.

Réglez votre siège selon ces recommandations de la NHTSA, tout en conservant le contrôle des pédales, du volant et la visibilité des commandes du tableau de bord.

 CAUTION

■ **Précautions avec le coussin gonflable SRS**

● Si vous attachez une rallonge de ceinture de sécurité aux boucles de ceinture de sécurité avant, mais pas au pêne de la ceinture de sécurité, les coussins gonflables avant SRS détectent que le conducteur et le passager avant ont attaché leur ceinture de sécurité, alors même que ce n'est pas le cas. Dans ce cas, il se peut que les coussins gonflables avant SRS ne se déploient pas correctement en cas d'accident et vous risquez d'être tué ou grièvement blessé. Veillez à porter la ceinture de sécurité avec la rallonge de ceinture de sécurité.

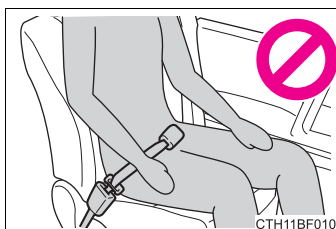

● Le coussin gonflable passager avant SRS se déploie également avec une violence considérable, qui peut être très dangereuse, voire mortelle, si le passager avant se trouve très près du coussin gonflable. Éloignez le siège du passager avant au maximum du coussin gonflable et réglez le dossier de siège de façon à être assis bien droit dans le siège.

● Les nourrissons et les enfants qui ne sont pas correctement assis et/ou protégés peuvent être grièvement blessés ou tués par le déploiement d'un coussin gonflable. Installez dans un siège de sécurité enfant les enfants trop jeunes pour pouvoir utiliser la ceinture de sécurité. Toyota recommande vivement que les nourrissons et les jeunes enfants soient installés sur le siège arrière du véhicule et convenablement attachés. Les sièges arrière sont plus sûrs pour les nourrissons et les enfants que le siège du passager avant.

● N'installez jamais un siège de sécurité enfant type dos à la route sur le siège du passager avant, même si le témoin indicateur "AIR BAG OFF" est allumé.

En cas d'accident, par la violence et la vitesse de son déploiement, le coussin gonflable passager avant peut blesser grièvement, voire tuer l'enfant si le siège de sécurité enfant type dos à la route est installé sur le siège du passager avant.

**⚠ CAUTION**

**■ Précautions avec le coussin gonflable SRS**

- Ne vous asseyez pas sur le bord du siège et ne vous appuyez pas contre le tableau de bord.

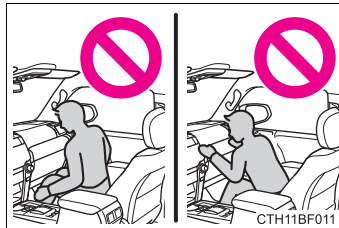

- Ne laissez pas un enfant se tenir debout devant le coussin gonflable passager avant SRS ou bien s'asseoir sur les genoux du passager avant.

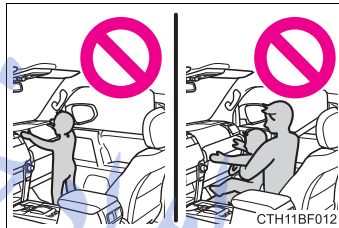

- Ne laissez pas les occupants des sièges avant voyager avec un objet sur les genoux.

- Ne vous appuyez pas contre la porte, contre le rail latéral de toit ou contre les montants avant, latéraux et arrière.



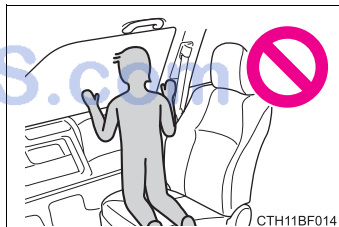

- Ne laissez personne s'agenouiller sur les sièges des passagers en appui contre la porte ou sortir la tête ou les mains à l'extérieur du véhicule.

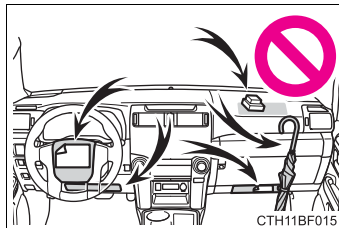

- Ne fixez ni ne posez aucun objet sur le tableau de bord, la garniture du volant de direction et la partie inférieure du tableau de bord.

Au déploiement des coussins gonflables conducteur SRS, passager avant et genoux, tout objet risque de se transformer en projectile.



 CAUTION

■ **Précautions avec le coussins gonflable SRS**

- Ne rien fixer aux portes, à la vitre du pare-brise, aux vitres latérales, aux montants avant et arrière, au rail latéral de toit et à la poignée d'assistance.

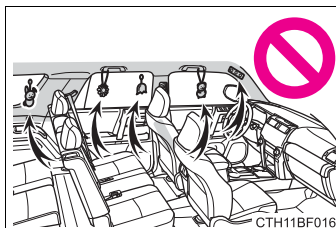

- Véhicules dépourvus de système d'accès "mains libres": ne fixez pas des objets lourds, pointus ou très durs, comme des clés et des accessoires par exemple. Ces objets risquent d'entraver le déploiement du coussin gonflable de genoux SRS ou d'être projetés vers le siège conducteur par la force de déploiement, constituant ainsi un danger potentiel.

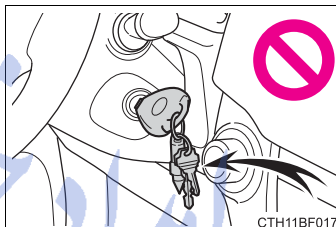

- Ne suspendez aucun cintre ou objets durs aux crochets à vêtements. En cas de déploiement des coussins gonflables rideaux SRS, tous ces objets pourraient se transformer en projectiles et causer des blessures graves, voire mortelles.
- Si un cache en vinyle recouvre la partie où le coussin gonflable de genoux SRS se déploie, veillez à l'enlever.
- N'utilisez aucun accessoire de siège venant recouvrir les zones de déploiement des coussins gonflables latéraux SRS, car il risquerait d'en gêner le déploiement. De tels accessoires peuvent empêcher les coussins gonflables latéraux de fonctionner correctement, désactiver le dispositif ou entraîner le déploiement accidentel des coussins gonflables latéraux, ce qui pourrait entraîner la mort ou des blessures graves.
- Évitez de faire subir des chocs ou des pressions excessives aux zones renfermant les composants des coussins gonflables SRS. En effet, cela pourrait entraîner un fonctionnement anormal des coussins gonflables SRS.
- Ne touchez aucun composant du système immédiatement après le déploiement (gonflage) des coussins gonflables SRS, car ils peuvent être chauds.

 CAUTION

■ **Précautions avec le coussins gonflable SRS**

- Si vous avez des difficultés à respirer après le déploiement des coussins gonflables SRS, ouvrez une porte ou une vitre pour faire entrer de l'air frais, ou bien descendez du véhicule si cela ne présente pas de danger. Essayez tout résidu dès que possible afin d'éviter d'éventuelles irritations de la peau.
- Si les parties renfermant les coussins gonflables SRS, telles que la garniture du volant et les garnitures de montants avant et arrière, sont abîmées ou craquelées, faites-les remplacer par votre concessionnaire Toyota.

■ **Modification et mise au rebut des éléments du système de coussins gonflables SRS**

Consultez impérativement votre concessionnaire Toyota si vous avez besoin d'intervenir sur votre véhicule ou de procéder à l'une des modifications suivantes. Les coussins gonflables SRS peuvent être défectueux ou se déployer (se gonfler) accidentellement, provoquant la mort ou de graves blessures.

- Installation, dépose, démontage et réparation des coussins gonflables SRS
- Réparations, modifications, démontage ou remplacement du volant, du tableau de bord, de la planche de bord, des sièges ou de leur garniture, des montants avant, latéraux et arrière ou des rails latéraux de toit
- Réparations ou modifications des ailes avant, du pare-chocs avant ou des flancs de l'habitacle
- Installation d'un protège-calandre (pare-buffle, pare-kangourou, etc.), de chasse-neiges, de treuils ou d'une galerie de pavillon.
- Modifications du système de suspension du véhicule
- Installation d'appareils électroniques, tels qu'une radio émetteur/récepteur ou un lecteur CD
- Aménagements du véhicule visant à permettre sa conduite par une personne atteinte d'un handicap physique

# امداد خودرو فارما

تلفن شبانه روزی: ۰۲۱-۸۸۸۶۲۰۸۵

**FarmaSOS.com**



## Index

507

What to do if... (Troubleshooting) .....	508
Alphabetical index .....	514

# امداد خودرو فارما

تلفن شبانه روزی: ۰۲۱-۸۸۸۶۲۰۸۵

## FarmaSOS.com

For details of equipment related to the audio/navigation system, refer to the "Navigation System Owner's Manual".

## What to do if... (Troubleshooting)

**If you have a problem, check the following before contacting your Toyota dealer.**

### **The doors cannot be locked, unlocked, opened or closed**



#### **You lose your keys**

- If you lose your keys or mechanical keys, new genuine mechanical keys can be made by your Toyota dealer. (→P. 97)
- If you lose your keys or electronic keys, the risk of vehicle theft increases significantly. Contact your Toyota dealer immediately. (→P. 99)



#### **The doors cannot be locked or unlocked**

- Is the key battery weak or depleted? (→P. 385)
- Vehicles with a smart key system:  
Is the engine switch in IGNITION ON mode?  
When locking the doors, turn the engine switch off. (→P. 196)
- Vehicles with a smart key system:  
Is the electronic key left inside the vehicle?  
When locking the doors, make sure that you have the electronic key on your person.
- The function may not operate properly due to the condition of the radio wave. (→P. 110)

**The rear door cannot be opened**

- Is the child-protector lock set?

The rear door cannot be opened from inside the vehicle when the lock is set. Open the rear door from outside and then unlock the child-protector lock. (→P. 103)

---

امداد خودرو فارما

تلفن شبانه روزی: ۰۲۱-۸۸۸۶۲۰۸۵

FarmaSOS.com

### If you think something is wrong



#### The engine does not start (vehicles without a smart key system)

- Is the shift lever in P? (→P. 192)
- Is the steering wheel unlocked? (→P. 192)
- Is the battery discharged? (→P. 452)



#### The engine does not start (vehicles with a smart key system)

- Did you press the engine switch while firmly depressing the brake pedal? (→P. 195)
- Is the shift lever in P? (→P. 197)
- Is the electronic key anywhere detectable inside the vehicle? (→P. 108)
- Is the steering wheel unlocked? (→P. 198)
- Is the electronic key battery weak or depleted? (→P. 450)  
In this case, the engine can be started in a temporary way. (→P. 450)
- Is the battery discharged? (→P. 452)



#### The shift lever cannot be shifted from P even if you depress the brake pedal

- Vehicles without a smart key system:  
Is the engine switch in the "ON" position?  
If you cannot release the shift lever by depressing the brake pedal with the engine switch in the "ON" position. (→P. 448)
- Vehicles with a smart key system:  
Is the engine switch in IGNITION ON mode?  
If you cannot release the shift lever by depressing the brake pedal with the engine switch in IGNITION ON mode. (→P. 448)



### The steering wheel cannot be turned after the engine is stopped

- Vehicles without a smart key system:  
It is locked to prevent theft of the vehicle if the key is pulled from the engine switch. (→P. 193)
  - Vehicles with a smart key system:  
It is locked automatically to prevent theft of the vehicle. (→P. 198)
- 



### The windows do not open or close by operating the power window switches

- Is the window lock switch pressed?  
The power window except for the one at the driver's seat cannot be operated if the window lock switch is pressed. (→P. 148)
- 



### The engine switch is turned off automatically (vehicles with a smart key system)

- The auto power off function will be operated if the vehicle is left in ACCESSORY or IGNITION ON mode (the engine is not running) for a period of time. (→P. 197)
-



### A warning buzzer sounds during driving

- The seat belt reminder light is flashing  
Are the driver and the front passenger wearing the seat belts?  
(→P. 421)
  - The brake system warning light is on  
Is the parking brake released? (→P. 204)
  - The open door warning indicator is on  
Are all the doors closed? (→P. 100, 117)
- Depending on the situation, other types of warning buzzer may also sound. (→P. 418, 426)
- 



### An alarm is activated and the horn sounds

- Did anyone inside the vehicle open a door during setting the alarm?  
The sensor detects it and the alarm sounds. (→P. 72)
- To stop the alarm, turn the engine switch to IGNITION ON mode (vehicles with a smart key system) or start the engine.
- 



### A warning buzzer sounds when leaving the vehicle (vehicles with a smart key system)

- Is the electronic key left inside the vehicle?  
Check the message on the multi-information display.
- 



### A warning light turns on or a warning message is displayed

- When a warning light turns on, refer to P. 418.
- When a warning light turns on or a warning message or indicator is displayed, refer to P. 418, 426.

**When a problem has occurred****If you have a flat tire**

- Stop the vehicle in a safe place and replace the flat tire with the spare tire. (→P. 433)

**The vehicle becomes stuck**

- Try the procedure for when the vehicle becomes stuck in mud, dirt, or snow. (→P. 458)

تلفن شبانه روزی: ۰۲۱-۸۸۸۶۲۰۸۵

FarmaSOS.com

## Alphabetical index

## A

- A/C** ..... 280, 286  
 Air conditioning filter ..... 383
- ABS**  
**(Anti-lock Brake System)**..... 260  
 Function ..... 260  
 Warning light..... 419
- Accessory meter**..... 89
- Active head restraints** ..... 123
- Active traction control** ..... 240
- Air conditioning filter** ..... 383
- Air conditioning**  
**system**..... 280, 286  
 Air conditioning filter ..... 383
- Airbags** ..... 35  
 Airbag operating conditions .... 42  
 Airbag precautions  
 for your child..... 37  
 Airbag warning light ..... 419  
 Correct driving posture ..... 28  
 Curtain shield airbag  
 operating conditions ..... 42  
 Curtain shield airbag  
 precautions..... 39  
 Front passenger occupant  
 classification system..... 46  
 General airbag precautions .... 37  
 Locations of airbags..... 35  
 Modification and disposal  
 of airbags..... 41  
 Side airbag operating  
 conditions ..... 42  
 Side airbag precautions ..... 37  
 Side and curtain shield airbags  
 operating conditions ..... 42  
 Side and curtain shield  
 airbags precautions ..... 37  
 SRS airbags..... 35
- Alarm** ..... 72  
 Alarm ..... 72  
 Warning buzzer ..... 418
- Anchor brackets**..... 57
- Antennas**  
**(smart key system)** ..... 107
- Anti-lock Brake System**  
**(ABS)**..... 260  
 Function..... 260  
 Warning light..... 419
- Armrest**..... 321
- Assist grip**..... 322
- Audio system\***
- AUTO LSD system**..... 242
- Automatic air conditioning**  
**system**..... 286
- Automatic light control**  
**system**..... 205
- Automatic running boards** .... 114
- Automatic transmission** ..... 200  
 If the shift lever  
 cannot be shifted from P .... 448  
 S mode ..... 201
- AUX port\***
- Auxiliary boxes**..... 302

\*: Refer to the "Navigation System Owner's Manual".



**B**

<b>Back door</b>	
Back door.....	117
Back window.....	151
Smart key system .....	107
Wireless remote control .....	100
<b>Back-up lights</b>	
Replacing light bulbs.....	403
Wattage .....	469
<b>Back window.....</b>	<b>151</b>
<b>Battery .....</b>	<b>367</b>
Battery checking .....	367
If the vehicle battery is discharged .....	452
Preparing and checking before winter.....	269
Warning light.....	418
<b>Bottle holders .....</b>	<b>304</b>
<b>Brake</b>	
Fluid .....	364
Parking brake.....	204
Warning light.....	418
<b>Brake assist .....</b>	<b>260</b>
<b>Break-in tips.....</b>	<b>161</b>
<b>Brightness control</b>	
Instrument panel light control.....	82

**C**

<b>Care .....</b>	<b>342, 344</b>
Aluminum wheels .....	342
Exterior .....	342
Interior .....	344
Seat belts.....	345
<b>Cargo capacity.....</b>	<b>175</b>
<b>Cargo hooks .....</b>	<b>305</b>
<b>Cargo net hooks .....</b>	<b>306</b>
<b>Center differential lock .....</b>	<b>236</b>
<b>Chains .....</b>	<b>271</b>
<b>Child restraint system.....</b>	<b>53</b>
Booster seats, definition .....	54
Booster seats, installation.....	65
Convertible seats, definition ...	54
Convertible seats, installation .....	62
Front passenger occupant classification system .....	46
Infant seats, definition.....	54
Infant seats, installation .....	62
Installing CRS with LATCH anchors .....	59
Installing CRS with seat belts.....	62
Installing CRS with top tether strap.....	66

**Child safety ..... 52**  
 Airbag precautions ..... 37  
 Back door precautions ..... 119  
 Battery precautions ..... 368, 454  
 Child restraint system ..... 53  
 How your child should  
     wear the seat belt ..... 31  
 Installing child restraints ..... 57  
 Moon roof precautions ..... 158  
 Power window lock switch ... 148  
 Power window precautions ... 150  
 Rear door child-protectors .... 103  
 Removed electronic  
     key battery precautions ..... 387  
 Seat belt extender  
     precautions ..... 34  
 Seat belt precautions ..... 56  
 Seat heater precautions ..... 293  
**Child-protectors ..... 103**  
**Cleaning ..... 342, 344**  
 Aluminum wheels ..... 342  
 Exterior ..... 342  
 Interior ..... 344  
 Seat belts ..... 345  
**Clock ..... 311**  
**Compass ..... 335**  
**Condenser ..... 363**  
**Console box ..... 299**  
**Cooling system**  
     Engine overheating ..... 455  
**Crawl Control ..... 250**  
**Cruise control ..... 222**  
**Cup holders ..... 300**  
**Curtain shield airbags ..... 35**  
**Customizable features ..... 485**

**D**

**Daytime running light  
 system ..... 209**  
**Defogger**  
     Front windshield ..... 288  
     Outside rear view  
         mirrors ..... 282, 288  
     Rear window ..... 282, 288  
**Dimension ..... 460**  
**Dinghy towing ..... 191**  
**Display**  
     Multi-information display ..... 81  
     Trip information ..... 83, 90  
     Warning message ..... 426  
**Do-it-yourself maintenance .... 353**  
**Door courtesy lights**  
     Wattage ..... 469  
**Doors**  
     Automatic door locking  
         and unlocking system ..... 104  
     Back door ..... 117  
     Door windows ..... 148  
     Door lock ..... 102, 118  
     Open door warning buzzer ... 109  
     Open door warning light ..... 420  
     Outside rear view mirrors .... 146  
     Rear door child-protector ..... 103  
     Side doors ..... 100  
**Downhill assist control  
 system ..... 247**  
**Driver's seat position  
 memory ..... 135**  
**Driving ..... 160**  
     Break-in tips ..... 161  
     Correct driving posture ..... 28  
     Driving assist systems ..... 260  
     Off-road precautions ..... 273  
     Procedures ..... 160  
     Winter drive tips ..... 269

**E**

- Eco Driving Indicator** ..... 83
- EDR (Event data recorder)**..... 10
- Electronic key** ..... 94
- Battery-saving function ..... 110
  - If the electronic key does not operate properly ..... 450
  - Replacing the battery ..... 385
- Emergency, in case of**
- If the electronic key does not operate properly ..... 450
  - If the engine will not start ..... 446
  - If the shift lever cannot be shifted from P .... 448
  - If the vehicle battery is discharged ..... 452
  - If the warning buzzer sounds ..... 418
  - If the warning light turns on ..... 418
  - If the warning message is displayed ..... 426
  - If you cannot operate back door opener ..... 449
  - If you have a flat tire ..... 433
  - If you think something is wrong ..... 416
  - If your vehicle becomes stuck ..... 458
  - If your vehicle has to be stopped in an emergency ... 409
  - If your vehicle needs to be towed ..... 411
  - If your vehicle overheats ..... 455
- Emergency flashers** ..... 408
- Engine**
- Accessory mode ..... 196
  - Compartment ..... 357
  - Engine switch ..... 192, 195
  - Hood ..... 356
  - How to start the engine ..... 192, 195
  - Identification number ..... 461
  - If the engine will not start ..... 446
  - Ignition switch (engine switch) ..... 192, 195
  - Overheating ..... 455
- Engine coolant**..... 362
- Capacity ..... 464
  - Checking ..... 362
  - Preparing and checking before winter ..... 269
- Engine coolant temperature gauge** ..... 81
- Engine immobilizer system** ..... 70
- Engine oil** ..... 359
- Capacity ..... 463
  - Checking ..... 359
  - Preparing and checking before winter ..... 269
- Engine switch** ..... 192, 195
- Event data recorder (EDR)**..... 10

**F**

<b>Flat tire</b> .....	<b>433</b>
<b>Floor mats</b> .....	<b>26</b>
<b>Fluid</b>	
Automatic transmission.....	467
Brake .....	467
Power steering.....	468
Washer .....	370
<b>Fog lights</b> .....	<b>211</b>
Replacing light bulbs.....	391
Switch .....	211
Wattage .....	469
<b>Four-wheel drive system</b> .....	<b>232, 236</b>
<b>Front passenger occupant classification system</b> .....	<b>46</b>
<b>Front personal lights</b> .....	<b>296</b>
<b>Front seats</b> .....	<b>122</b>
Adjustment.....	122
Cleaning.....	344
Correct driving posture .....	28
Driving position memory .....	135
Head restraints .....	139
Seat heaters .....	293
Seat position memory .....	135
Seat ventilators .....	293
<b>Front side marker lights</b> .....	<b>205</b>
Light switch .....	205
Replacing light bulbs.....	398
Wattage .....	469

<b>Front turn signal lights</b> .....	<b>203</b>
Replacing light bulbs .....	396
Turn signal lever .....	203
Wattage .....	469
<b>Fuel</b> .....	<b>219</b>
Capacity.....	462
Fuel gauge.....	81
Fuel pump shut off system ...	417
Information.....	470
Refueling .....	219
Type.....	219, 462
Warning light.....	420
<b>Fuel filler door</b> .....	<b>219</b>
Refueling .....	219
<b>Fuel pump shut off system</b> .....	<b>417</b>
<b>Fuses</b> .....	<b>388</b>

**G**

<b>Garage door opener</b> .....	<b>323</b>
<b>Gauges</b> .....	<b>81</b>
<b>Glove box</b> .....	<b>299</b>
<b>Grocery bag hooks</b> .....	<b>308</b>

**H**

<b>Head restraints</b> .....	139
<b>Headlights</b> .....	205
Light switch .....	205
Replacing light bulbs .....	393, 395, 405
Wattage .....	469
<b>Heaters</b>	
Air conditioning system .....	280, 286
Seat heaters .....	293
Outside rear view mirrors .....	282, 288
<b>Hill-start assist control</b> .....	261
<b>Horn</b> .....	142
<b>Hood</b> .....	356
<b>Hooks</b>	
Cargo hooks .....	305
Cargo net hooks .....	306
Grocery bag hooks .....	308
Retaining hooks (floor mat) .....	26

**I**

<b>I/M test</b> .....	352
<b>Identification</b>	
Engine .....	461
Vehicle .....	461
<b>Ignition switch (engine switch)</b> .....	192, 195
<b>Illuminated entry system</b> .....	297
<b>Immobilizer system</b> .....	70
<b>Indicators</b> .....	79
<b>Initialization</b>	
Moon roof .....	157
Power back window .....	153
Power windows .....	149
Maintenance .....	348
<b>Inside rear view mirror</b> .....	144
<b>Instrument panel light control</b> .....	82
<b>Interior lights</b> .....	295
<b>Intuitive parking assist</b> .....	226

**J**

<b>Jack</b> .....	433
Vehicle-equipped jack .....	433
<b>Jack handle</b> .....	437
<b>Jam protection function</b>	
Moon roof .....	156
Power back window .....	153
Power windows .....	149

**K**

<b>KDSS</b> .....	<b>261</b>
<b>Keyless entry</b> .....	<b>107</b>
Smart key system .....	107
Wireless remote control .....	100
<b>Keys</b> .....	<b>94</b>
Battery-saving function .....	110
Electronic key .....	94
Engine switch.....	192, 195
If the electronic key does not operate properly .....	450
Key number plate.....	94
Keyless entry .....	100
Mechanical key .....	96
Replacing the battery.....	385
Warning buzzer.....	109
Wireless remote control key .....	100
<b>Knee airbags</b> .....	<b>35</b>

**L**

<b>LATCH anchors</b> .....	<b>59</b>
<b>Lever</b>	
Auxiliary catch lever.....	356
Hood lock release lever .....	356
Shift lever.....	200
Turn signal lever .....	203
Wiper lever.....	213, 216

**License plate lights** .....

<b>205</b>	
Light switch.....	205
Replacing light bulbs .....	404
Wattage .....	469

**Lights**

Fog light switch.....	211
Front Interior light .....	296
Headlight switch .....	205
Interior lights list.....	295
Luggage compartment lights.....	119
Personal lights.....	296
Rear interior light .....	296
Replacing light bulbs .....	393
Turn signal lever .....	203
Vanity lights .....	310
Wattage .....	469

**Light bulbs**

Replacing.....	393
Wattage .....	469

**Limited slip differential** .....

**Load capacity** .....

**Lock steering**

column .....	193, 197
--------------	----------

**Luggage compartment**

features .....	305
----------------	-----

4RUNNER (U)\_(OM35A83U)

M	N						
<p><b>Maintenance</b></p> <ul style="list-style-type: none"> <li>Do-it-yourself maintenance... 353</li> <li>General maintenance ..... 349</li> <li>Maintenance data ..... 460</li> <li>Maintenance requirements ... 347</li> <li>Reset the maintenance data ..... 348</li> </ul> <p><b>Malfunction indicator lamp..... 418</b></p> <p><b>Manual air conditioning system..... 280</b></p> <p><b>Master warning light..... 426</b></p> <p><b>Meter ..... 81</b></p> <ul style="list-style-type: none"> <li>Accessory meter ..... 89</li> <li>Indicators ..... 79</li> <li>Instrument panel light control..... 82</li> <li>Meters..... 81</li> <li>Multi-information display ..... 83</li> <li>Warning lights ..... 77</li> </ul> <p><b>Mirrors</b></p> <ul style="list-style-type: none"> <li>Inside rear view mirror ..... 144</li> <li>Outside rear view mirror defoggers ..... 282, 288</li> <li>Outside rear view mirrors..... 146</li> <li>Vanity mirrors..... 310</li> </ul> <p><b>Moon roof ..... 155</b></p> <ul style="list-style-type: none"> <li>Jam protection function..... 156</li> <li>Operation ..... 155</li> </ul> <p><b>Multi-information display ..... 83</b></p> <ul style="list-style-type: none"> <li>Customizing vehicle features ..... 86</li> <li>Driving monitor..... 84</li> <li>Switching the display ..... 84</li> <li>Trip information..... 83</li> <li>Warning message..... 426</li> </ul> <p><b>Multi Terrain ABS ..... 260</b></p> <p><b>Multi-terrain Select ..... 253</b></p>	<p><b>Navigation system*</b></p> <p><b>Noise from under vehicle ..... 8</b></p> <tr> <th style="text-align: center; background-color: #444; color: white;">O</th> <td></td> </tr> <tr> <td></td> <th style="text-align: center; background-color: #444; color: white;">O</th> </tr> <tr> <td></td> <td style="vertical-align: top;"> <p><b>Odometer ..... 81</b></p> <p><b>Off-road precautions..... 273</b></p> <p><b>Oil</b></p> <ul style="list-style-type: none"> <li>Engine oil..... 359</li> </ul> <p><b>Opener</b></p> <ul style="list-style-type: none"> <li>Back door ..... 118</li> <li>Hood ..... 356</li> </ul> <p><b>Outer foot lights ..... 295</b></p> <p><b>Outside rear view mirrors..... 146</b></p> <ul style="list-style-type: none"> <li>Adjusting and folding ..... 146</li> <li>Outside rear view mirror defoggers..... 282, 288</li> </ul> <p><b>Outside temperature display..... 312</b></p> <p><b>Overhead console ..... 302</b></p> <p><b>Overheating, Engine ..... 455</b></p> </td> </tr>	O			O		<p><b>Odometer ..... 81</b></p> <p><b>Off-road precautions..... 273</b></p> <p><b>Oil</b></p> <ul style="list-style-type: none"> <li>Engine oil..... 359</li> </ul> <p><b>Opener</b></p> <ul style="list-style-type: none"> <li>Back door ..... 118</li> <li>Hood ..... 356</li> </ul> <p><b>Outer foot lights ..... 295</b></p> <p><b>Outside rear view mirrors..... 146</b></p> <ul style="list-style-type: none"> <li>Adjusting and folding ..... 146</li> <li>Outside rear view mirror defoggers..... 282, 288</li> </ul> <p><b>Outside temperature display..... 312</b></p> <p><b>Overhead console ..... 302</b></p> <p><b>Overheating, Engine ..... 455</b></p>
O							
	O						
	<p><b>Odometer ..... 81</b></p> <p><b>Off-road precautions..... 273</b></p> <p><b>Oil</b></p> <ul style="list-style-type: none"> <li>Engine oil..... 359</li> </ul> <p><b>Opener</b></p> <ul style="list-style-type: none"> <li>Back door ..... 118</li> <li>Hood ..... 356</li> </ul> <p><b>Outer foot lights ..... 295</b></p> <p><b>Outside rear view mirrors..... 146</b></p> <ul style="list-style-type: none"> <li>Adjusting and folding ..... 146</li> <li>Outside rear view mirror defoggers..... 282, 288</li> </ul> <p><b>Outside temperature display..... 312</b></p> <p><b>Overhead console ..... 302</b></p> <p><b>Overheating, Engine ..... 455</b></p>						

\*: Refer to the "Navigation System Owner's Manual".

P	R
<b>Parking brake</b> ..... 204	<b>Radiator</b> ..... 363
Operation ..... 204	<b>Rear differential lock</b>
Parking brake engaged	<b>system</b> ..... 216
warning buzzer ..... 418	<b>Rear seats</b>
<b>Parking lights</b> ..... 205	Adjustment..... 125
Light switch ..... 205	Folding down ..... 127, 129, 131
Replacing light bulbs..... 396	<b>Rear step bumper</b> ..... 118
Wattage ..... 469	<b>Rear turn signal lights</b> ..... 203
<b>Pen holder</b> ..... 303	Replacing light bulbs ..... 402
<b>Personal lights</b> ..... 296	Turn signal lever ..... 203
<b>Power back window</b> ..... 151	Wattage ..... 469
Jam protection function..... 153	<b>Rear view mirror</b>
Operation ..... 151	Inside rear view mirror ..... 144
<b>Power outlets</b> ..... 314, 319	Outside rear view mirrors .... 146
<b>Power steering</b>	<b>Rear view monitor system*</b>
Fluid ..... 366	<b>Rear window</b> ..... 151
Warning light..... 420	<b>Rear window</b>
<b>Power windows</b> ..... 148	<b>defoggers</b> ..... 282, 288
Jam protection function..... 149	<b>Rear window wiper</b> ..... 244
Operation ..... 148	<b>Refueling</b> ..... 219
Window lock switch..... 148	Capacity..... 462
	Fuel types ..... 462
	Opening the fuel tank cap..... 221
	<b>Replacing</b>
	Fuses..... 388
	Key battery ..... 385
	Light bulbs ..... 391
	Tires..... 433
	<b>Reporting safety defects</b>
	<b>for U.S. owners</b> ..... 494
	<b>Reset the maintenance data</b> ... 348
	<b>Roof luggage carrier</b> ..... 170



## S

- Safety Connect** ..... 330
- Seat belt reminder light**..... 421
- Seat belts**..... 30
- Adjusting the seat belt ..... 30
  - Automatic Locking
    - Retractor (ALR) ..... 31
  - Child restraint system
    - installation ..... 62
  - Cleaning and maintaining
    - the seat belt..... 345
  - Emergency Locking
    - Retractor (ELR) ..... 31
  - How to wear your seat belt ..... 30
  - How your child should wear
    - the seat belt..... 31
  - Pregnant women, proper
    - seat belt use ..... 32
  - Reminder light and buzzer.... 421
  - Seat belt extender..... 31
  - Seat belt pretensioners..... 31
  - SRS warning light ..... 419
- Seat heaters** ..... 293
- Seat position memory** ..... 135
- Seat ventilators**..... 293
- Seating capacity** ..... 175
- Seats**..... 122, 125
- Adjustment..... 122, 125
  - Adjustment
    - precautions..... 124, 134
  - Child seats/child restraint
    - system installation..... 57
  - Cleaning ..... 344
  - Driving position memory ..... 135
  - Head restraints ..... 139
  - Properly sitting in the seat ..... 28
  - Seat heaters ..... 293
  - Seat position memory..... 135
  - Seat ventilators..... 293
- Sensor**
- Automatic headlight
    - system..... 209
  - Inside rear view mirror ..... 145
  - Intuitive parking assist ..... 226
- Service reminder indicators** ..... 76
- Shift lever** ..... 200
- Automatic transmission ..... 200
  - If the shift lever
    - cannot be shifted from P .... 448
- Shift lock system**..... 448
- Side airbags** ..... 35
- Side marker lights** ..... 205
- Light switch..... 205
  - Replacing light bulbs ..... 398
  - Wattage ..... 469

\*: Refer to the “Navigation System Owner’s Manual”.

- Side mirrors** ..... 146  
 Adjusting and folding ..... 146
- Side turn signal lights** ..... 203
- Smart key system** ..... 107  
 Antenna location ..... 107  
 Entry functions ..... 100  
 Starting the engine ..... 195
- Snow tires** ..... 272
- Slide deck** ..... 308
- Spare tire** ..... 433  
 Inflation pressure ..... 468  
 Storage location ..... 434
- Spark plug** ..... 464
- Specifications** ..... 460
- Speedometer** ..... 81
- Steering lock** ..... 197  
 Column lock release ..... 198  
 Steering lock system  
 warning message ..... 432
- Steering wheel** ..... 142  
 Adjustment ..... 142
- Storage feature** ..... 298
- Storage precautions** ..... 173
- Stuck**  
 If the vehicle becomes  
 stuck ..... 458
- Sun visors** ..... 310
- Switches**  
 Compass switch ..... 335  
 Cruise control switch ..... 222  
 "DISP" button ..... 84  
 Door lock switches ..... 102  
 Driving position memory  
 switches ..... 135  
 Emergency flashers switch ... 408  
 Engine switch ..... 192, 195  
 Fog light switch ..... 211  
 Garage door opener  
 switches ..... 323  
 Ignition switch ..... 192, 195  
 Light switches ..... 205  
 Moon roof switches ..... 155  
 Outside rear view mirror  
 switches ..... 146  
 Power back window  
 switch ..... 151  
 Power door lock switch ..... 102  
 Power window switches ..... 148  
 Rear window wiper and  
 washer switch ..... 216

FarmaSOS.com

Rear window and outside  
 rear view mirror defoggers  
 switch ..... 282, 288  
 Seat heater switches ..... 293  
 Seat ventilator switches ..... 293  
 "SOS" button..... 330  
 Telephone switches\*  
 VSC OFF switch ..... 262  
 Window lock switch..... 148  
 Windshield wipers  
 and washer switch..... 213

## T

**Tachometer** ..... 81  
**Tail lights**..... 205  
 Light switch..... 205  
**Telephone switches\***  
**Theft deterrent system**  
 Alarm ..... 72  
 Engine immobilizer system..... 70  
**Tire inflation pressure**..... 377  
 Maintenance data ..... 468  
 Warning light..... 421  
**Tire information** ..... 473  
 Glossary ..... 479  
 Size..... 475  
 Tire identification number .... 474  
 Uniform Tire Quality  
 Grading ..... 477  
**Tire pressure warning  
 system**..... 373  
 Function..... 373  
 Installing tire pressure warning  
 valves and transmitters ..... 373  
 Registering ID codes ..... 373  
 Warning light..... 421

\*: Refer to the "Navigation System Owner's Manual".

<b>Tires</b> .....	<b>372</b>	<b>Turn signal lights</b> .....	<b>203</b>
Chains.....	271	Replacing light bulbs ....	396, 402
Checking.....	372	Turn signal lever .....	203
If you have a flat tire .....	433	Wattage .....	469
Inflation pressure .....	468		
Information.....	473	<b>U</b>	
Replacing.....	433	<b>USB port*</b>	
Rotating tires.....	372		
Size.....	468	<b>V</b>	
Snow tires .....	272	<b>Valet key</b> .....	<b>94</b>
Spare tire .....	433	<b>Vanity lights</b> .....	<b>310</b>
Tire pressure warning		Wattage .....	469
system.....	373	<b>Vanity mirrors</b> .....	<b>310</b>
Warning light.....	421	<b>Vehicle data recordings</b> .....	<b>9</b>
<b>Tools</b> .....	<b>434</b>	<b>Vehicle identification</b>	
<b>Top tether strap</b> .....	<b>66</b>	number.....	461
<b>Total load capacity</b> .....	<b>175</b>	<b>Vehicle Stability Control</b>	
<b>Towing</b>		<b>(VSC)</b> .....	<b>260</b>
Dinghy towing .....	191	<b>Ventilators</b>	
Emergency towing .....	411	<b>(seat ventilators)</b> .....	<b>293</b>
Trailer towing .....	176	<b>VSC</b>	
<b>TRAC (Traction Control)</b> .....	<b>260</b>	<b>(Vehicle Stability Control)</b> ....	<b>260</b>
<b>Trailer Sway Control</b> .....	<b>260</b>		
<b>Transmission</b> .....	<b>200</b>		
<b>Trip information</b> .....	<b>83</b>		
<b>Trip meters</b> .....	<b>81</b>		

FarmaSOS.com

**W****Warning buzzers**

Brake system .....	418
Downshifting .....	202
Intuitive parking assist .....	226
Key reminder .....	193, 422, 429
Open door .....	420
Open moon roof reminder.....	422
Seat belt reminder .....	421

**Warning lights..... 77**

ABS.....	419
Automatic running boards	
indicator light .....	420
Brake system .....	418
Center differential lock	
indicator light .....	420
Charging system.....	418
Cruise control.....	419
Four-wheel drive	
indicator light .....	419
KDSS.....	420
Low engine oil pressure.....	418
Low fuel level.....	420
Low speed four-wheel drive	
indicator light .....	420
Malfunction indicator lamp ....	418
Master warning light.....	421, 426
Multi-terrain Select	
indicator light .....	420
Open door.....	420
Power steering.....	420
Rear differential lock	
indicator light .....	419
Seat belt reminder light.....	421
Slip indicator .....	419
SRS .....	419
Tire pressure.....	421
Unengaged "Park" .....	420

**Warning messages..... 426****Washer .....** 213

Checking.....	370
Preparing and checking	
before winter .....	269
Switch .....	213, 216

**Washing and waxing..... 342****Weight**

Cargo capacity.....	175
Load limits .....	175
Weight .....	460

**Wheels..... 380**

Replacing wheels .....	380
Size.....	468

**Window glasses .....** 148**Window lock switch .....** 148**Windows..... 148**

Power back window.....	151
Power windows.....	148
Rear window	
defogger .....	282, 288
Washer .....	213, 216

**Windshield wiper****de-icer .....** 282, 289**Windshield wipers..... 213, 216**

Intermittent wiper .....	213
--------------------------	-----

**Winter driving tips..... 269****Wireless remote control****key..... 95**

Locking/Unlocking .....	100
Replacing the battery.....	385

\*: Refer to the "Navigation System Owner's Manual".

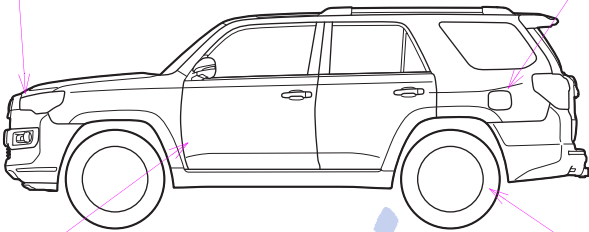
GAS STATION INFORMATION	
Auxiliary catch lever P. 356	Fuel filler door P. 221
 <p style="text-align: right; font-size: small;">CTHPIBF009</p>	
Hood lock release lever P. 356	Tire inflation pressure P. 468
Fuel tank capacity (Reference)	23.0 gal. (87.0 L, 19.1 Imp. gal.)
Fuel type	Unleaded gasoline only P. 219, 462
Cold tire inflation pressure	P. 468
Engine oil capacity (Drain and refill — reference)	P. 463
Engine oil type	P. 463