

## TABLE OF CONTENTS

1	<b>Before driving</b>	Adjusting and operating features such as door locks, mirrors, and steering column.
2	<b>When driving</b>	Driving, stopping and safe-driving information.
3	<b>Interior features</b>	Air conditioning and audio systems, as well as other interior features for a comfortable driving experience.
4	<b>Maintenance and care</b>	Cleaning and protecting your vehicle, performing do-it-yourself maintenance, and maintenance information.
5	<b>When trouble arises</b>	What to do if the vehicle needs to be towed, gets a flat tire, or is involved in an accident.
6	<b>Vehicle specifications</b>	Detailed vehicle information.
7	<b>For owners</b>	Reporting safety defects for U.S. owners and seat belt instructions for Canadian owners
	<b>Index</b>	Alphabetical listing of information contained in this manual.

**1 Before driving**

**1-1. Key information**

Keys ..... 24

**1-2. Opening, closing and locking the doors and trunk**

Smart key system..... 27  
 Wireless remote control ..... 38  
 Doors..... 42  
 Trunk ..... 47

**1-3. Adjustable components (seats, mirrors, steering wheel)**

Front seats ..... 51  
 Rear seats ..... 53  
 Head restraints ..... 55  
 Seat belts ..... 57  
 Steering wheel ..... 65  
 Anti-glare inside rear view mirror..... 66  
 Outside rear view mirrors..... 68

**1-4. Opening and closing the windows**

Power windows ..... 70  
 Moon roof ..... 72

**1-5. Refueling**

Opening the fuel tank cap ..... 76

**1-6. Theft deterrent system**

Engine immobilizer system ..... 80  
 Alarm ..... 82  
 Theft prevention labels (for U.S.A.) ..... 84

**1-7. Safety information**

Correct driving posture ..... 85  
 SRS airbags ..... 87  
 Front passenger occupant classification system..... 99  
 Child restraint systems ..... 104  
 Installing child restraints ..... 108

**2 When driving**

**2-1. Driving procedures**

Driving the vehicle ..... 120  
 Engine (ignition) switch (vehicles with smart key system) ..... 131  
 Engine (ignition) switch (vehicles without smart key system) ..... 135  
 Automatic transmission ..... 138  
 Manual transmission..... 142  
 Turn signal lever ..... 144  
 Parking brake ..... 145  
 Horn ..... 146

**2-2. Instrument cluster**

Gauges and meters ..... 147  
 Indicators and warning lights ..... 151  
 Multi-information display ..... 155

**2-3. Operating the lights and wipers**

Headlight switch..... 159  
Fog light switch ..... 163  
Windshield wipers and washer ..... 164

**2-4. Using other driving systems**

Cruise control..... 166  
Driving assist systems ..... 170

**2-5. Driving information**

Cargo and luggage ..... 175  
Vehicle load limits ..... 178  
Winter driving tips ..... 179  
Trailer towing ..... 183  
Dinghy towing (automatic transmission) ..... 191  
Dinghy towing (manual transmission) ..... 192

Using the CD player ..... 223  
Playing MP3 and WMA discs ..... 232  
Operating an iPod® player ..... 240  
Operating a USB memory player ..... 246  
Optimal use of the audio system..... 253  
Using the AUX adapter..... 258  
Using the steering wheel audio switches..... 260

**3-3. Using the Bluetooth® audio system**

Bluetooth® audio system.... 263  
Using the Bluetooth® audio system ..... 266  
Operating a Bluetooth® enabled portable player.... 271  
Setting up a Bluetooth® enabled portable player.... 273  
Bluetooth® audio system setup ..... 278

**3 Interior features**

**3-1. Using the air conditioning system and defogger**

Automatic air conditioning system ..... 196  
Manual air conditioning system ..... 204  
Rear window and outside rear view mirror defoggers..... 209

**3-2. Using the audio system**

Audio system types..... 211  
Using the radio..... 215

**3-4. Using the hands-free phone system (for cellular phone)**

Hands-free phone system (for cellular phone) features ..... 279  
Using the hands-free phone system (for cellular phone) ..... 283  
Making a phone call ..... 292  
Setting a cellular phone..... 296  
Security and system setup ..... 301  
Using the phone book ..... 305

1

2

3

4

5

6

7

8

9

**3-5. Using the interior lights**

Interior lights list ..... 313  
 • Interior light ..... 314  
 • Personal lights ..... 315

**3-6. Using the storage features**

List of storage features..... 316  
 • Glove box ..... 317  
 • Console box ..... 317  
 • Cup holders..... 319  
 • Auxiliary boxes ..... 321

**3-7. Other interior features**

Sun visors ..... 324  
 Vanity mirrors ..... 325  
 Clock ..... 326  
 Ashtray ..... 327  
 Power outlets ..... 328  
 Seat heaters ..... 330  
 Armrest..... 332  
 Rear sunshade ..... 333  
 Trunk storage extension..... 334  
 Floor mat ..... 335  
 Trunk features ..... 336  
 Garage door opener ..... 338  
 Compass ..... 343

**4 Maintenance and care**

**4-1. Maintenance and care**

Cleaning and protecting the vehicle exterior ..... 348  
 Cleaning and protecting the vehicle interior ..... 350

**4-2. Maintenance**

Maintenance requirements ..... 353  
 General maintenance ..... 355  
 Emission inspection and maintenance (I/M) programs ..... 358

**4-3. Do-it-yourself maintenance**

Do-it-yourself service precautions ..... 359  
 Hood ..... 362  
 Positioning a floor jack..... 363  
 Engine compartment ..... 365  
 Tires..... 382  
 Tire inflation pressure ..... 392  
 Wheels..... 396  
 Air conditioning filter ..... 398  
 Key battery ..... 401  
 Checking and replacing fuses ..... 405  
 Light bulbs ..... 418



## 5 When trouble arises

### 5-1. Essential information

Emergency flashers .....	424
If your vehicle needs to be towed .....	425
If you think something is wrong .....	428
Fuel pump shut off system .....	429
Event data recorder .....	430

### 5-2. Steps to take in an emergency

If a warning light turns on or a warning buzzer sounds... ..	432
If a warning message is displayed (vehicles with multi-information display) .....	444
If you have a flat tire .....	454
If the engine will not start ....	465
If the shift lever cannot be shifted from P (automatic transmission) .....	467
If you lose your keys .....	468
If the electronic key does not operate properly (vehicles with smart key system).....	469
If the battery is discharged .....	471
If your vehicle overheats .....	475
If the vehicle becomes stuck .....	478

## 6 Vehicle specifications

### 6-1. Specifications

Maintenance data (fuel, oil level, etc.) .....	482
Fuel information.....	495
Tire information .....	498

### 6-2. Customization

Customizable features.....	510
----------------------------	-----

### 6-3. Initialization

Items to initialize .....	514
---------------------------	-----

## 7 For owners

Reporting safety defects for U.S. owners .....	516
Seat belt instructions for Canadian owners (in French).....	517

## Index

Abbreviation list.....	522
Alphabetical index .....	523
What to do if... ..	533

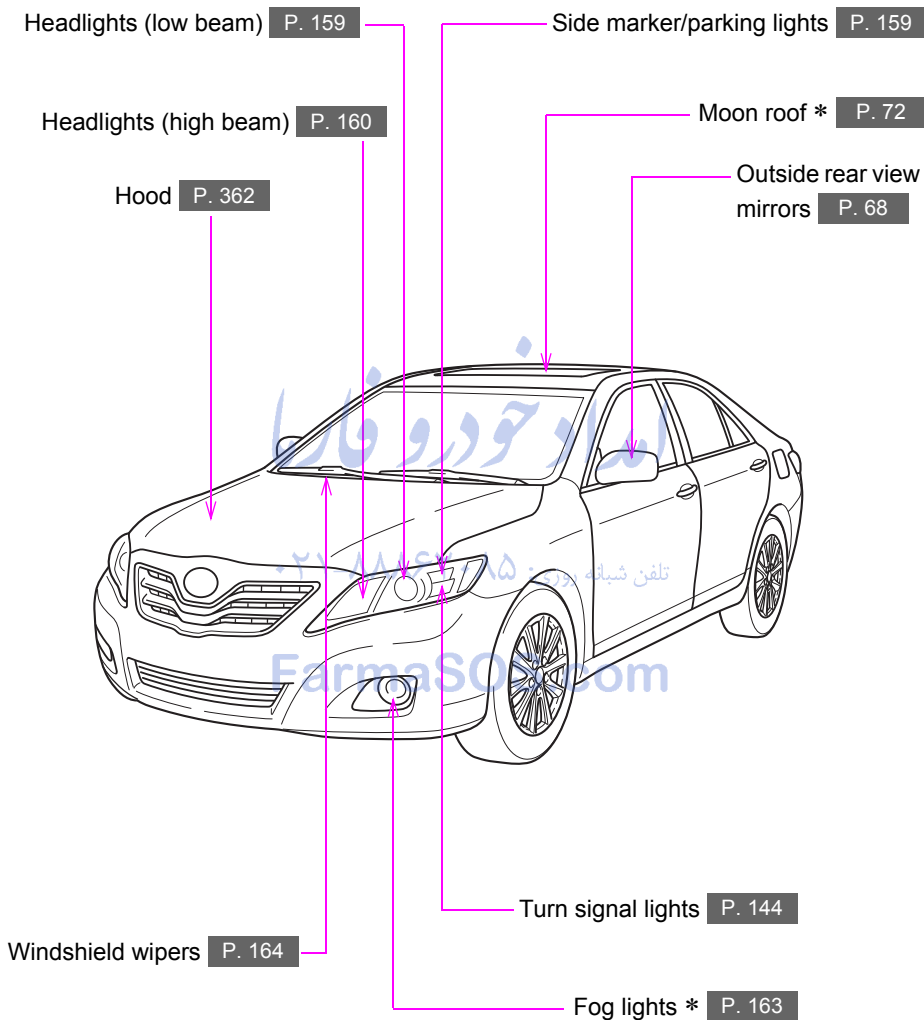

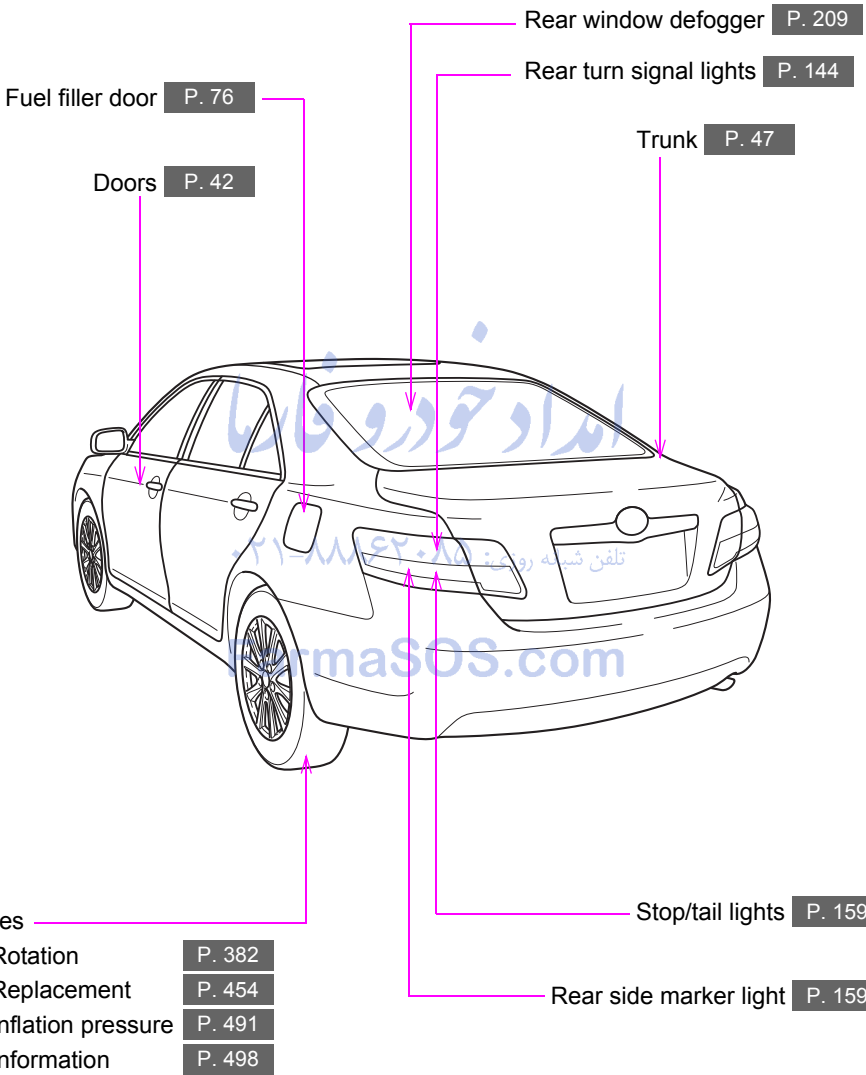

\*: If equipped

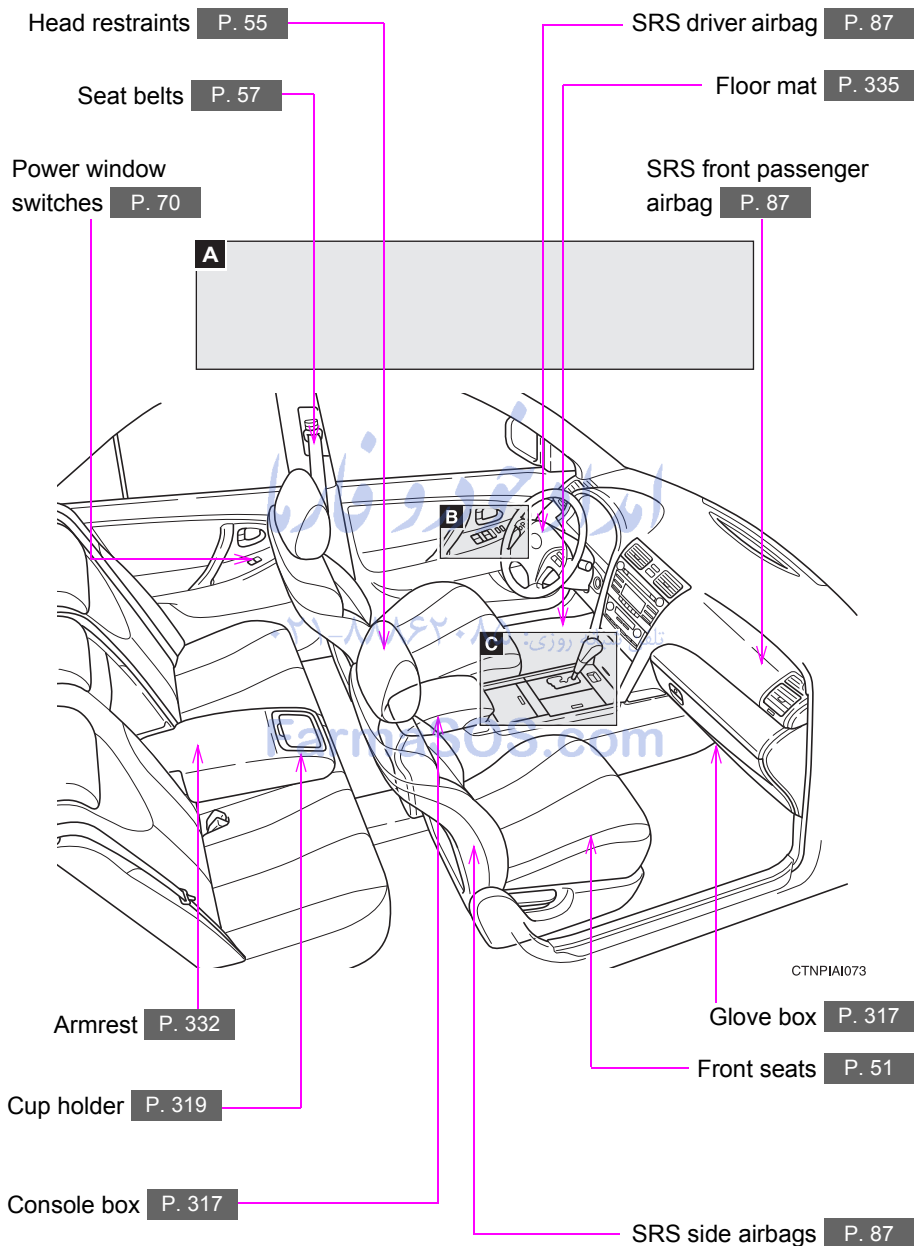

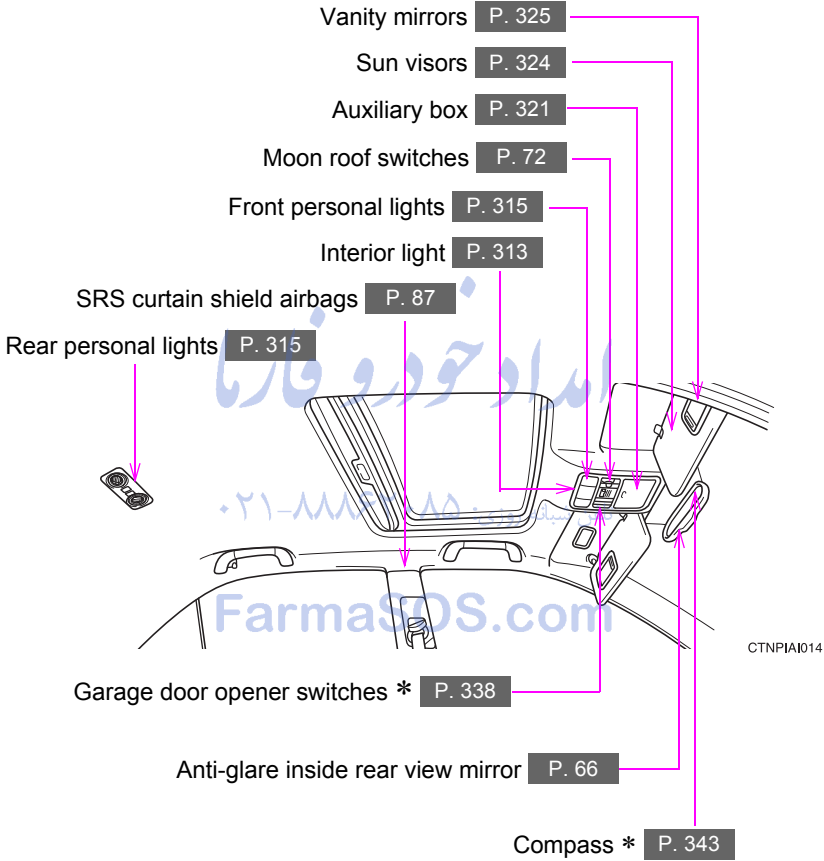
**A****► Vehicles with moon roof**

\*: If equipped

**A**

► **Vehicles without moon roof**

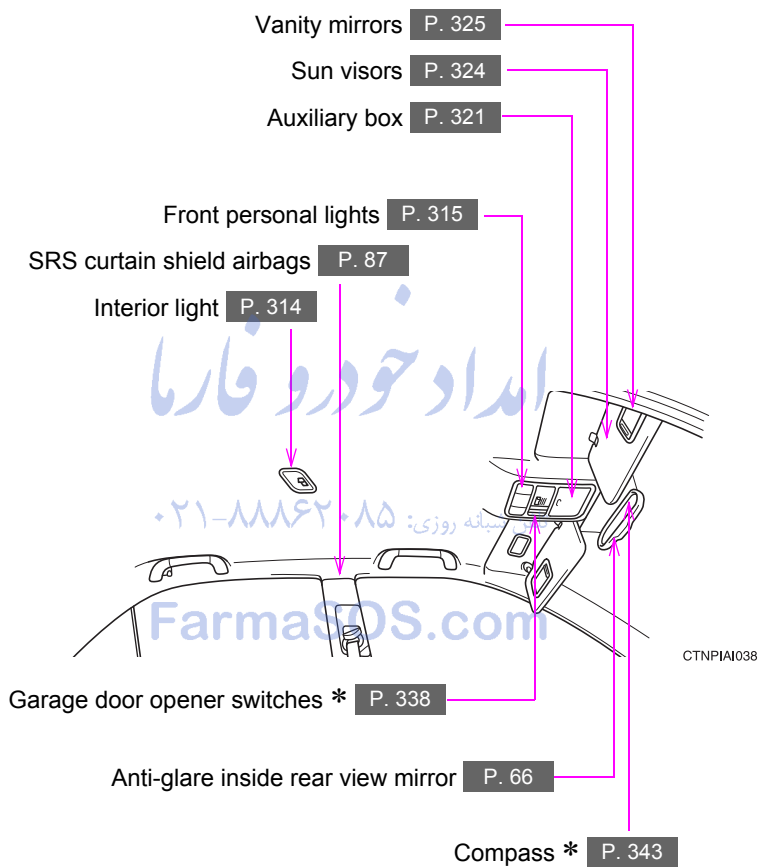

**B**

Inside lock button P. 43

Door lock switch P. 42

Window lock switch P. 70

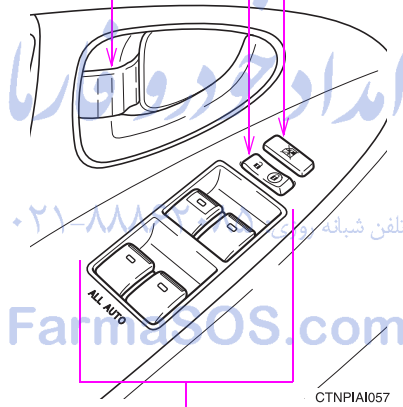

Power window switches P. 70

\*: If equipped

## C

### ► Automatic transmission

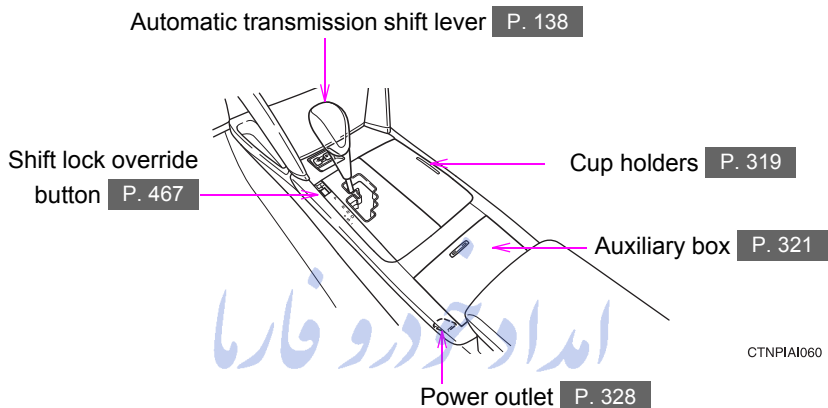

### ► Manual transmission

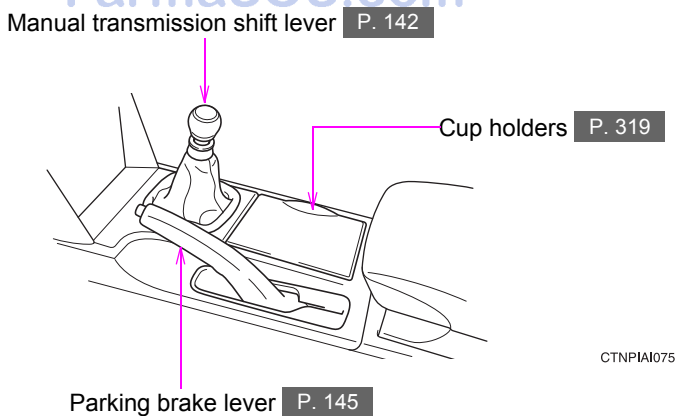



# Pictorial index

## Instrument panel

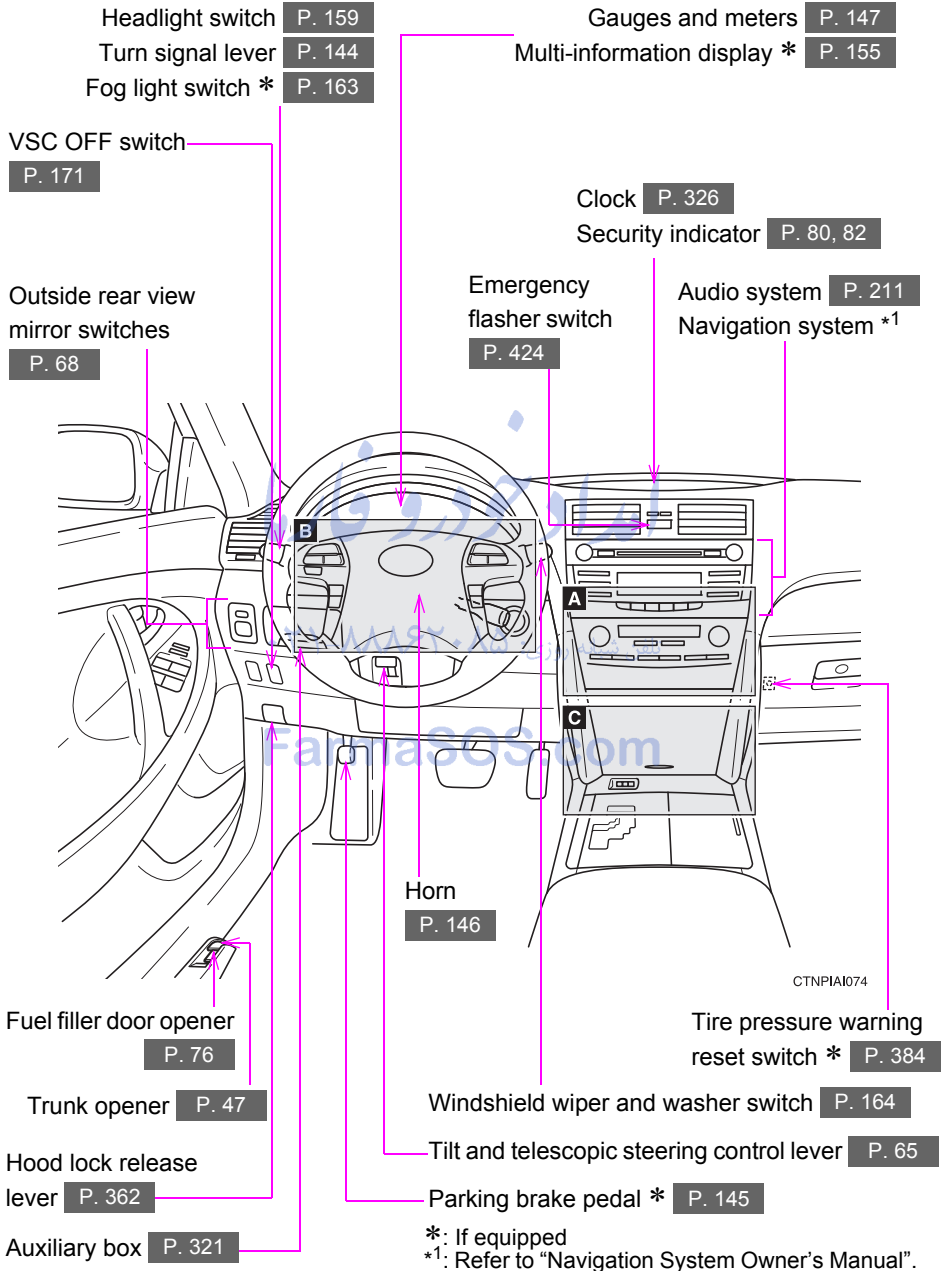

## A

### ► Automatic air conditioning system

Air conditioning system P. 196

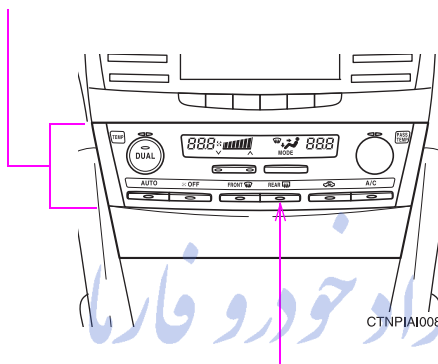

Rear window and outside rear view mirror defogger switch P. 209

تلفن شبانه روزی: ۰۲۱-۸۸۶۲۰۸۵

### ► Manual air conditioning system

Air conditioning system P. 204

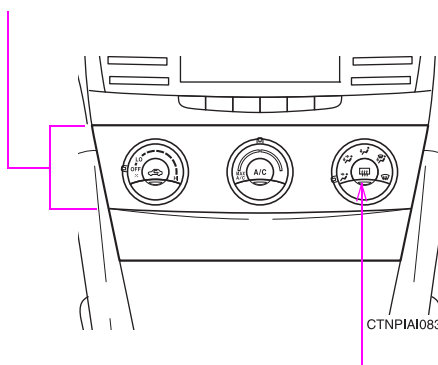

Rear window defogger switch P. 209

Outside rear view mirror defogger switch \* P. 209

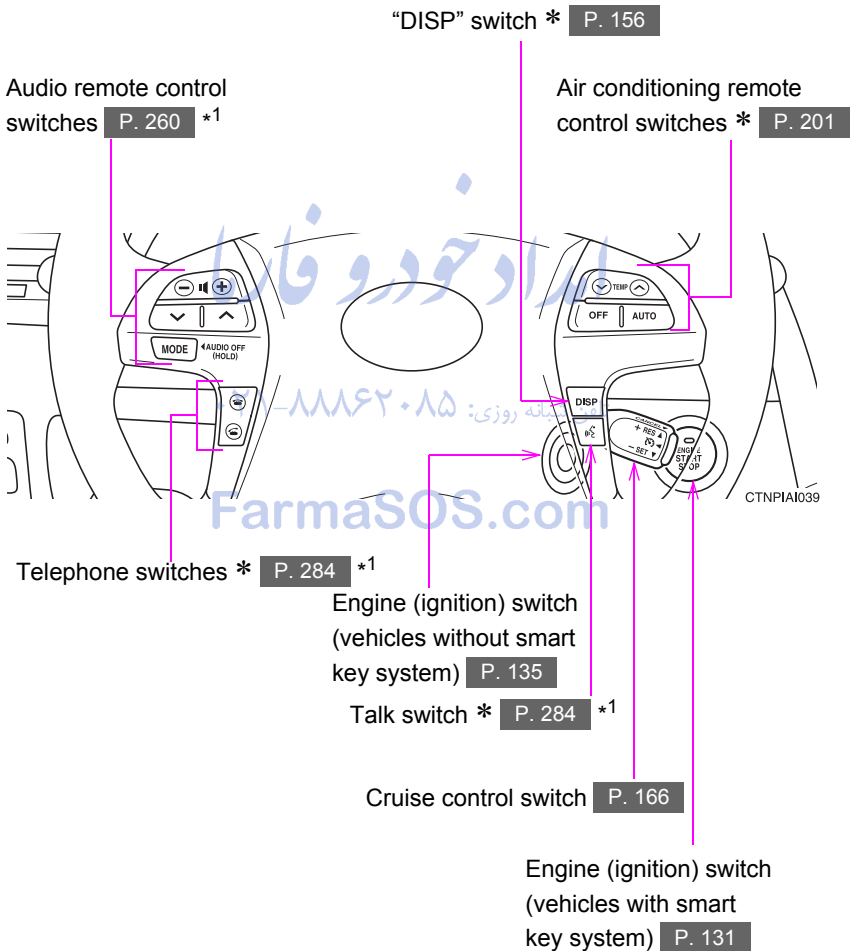
**B****► Type A**

\* : If equipped

\*1: Refer to "Navigation System Owner's Manual".

## B

### ► Type B

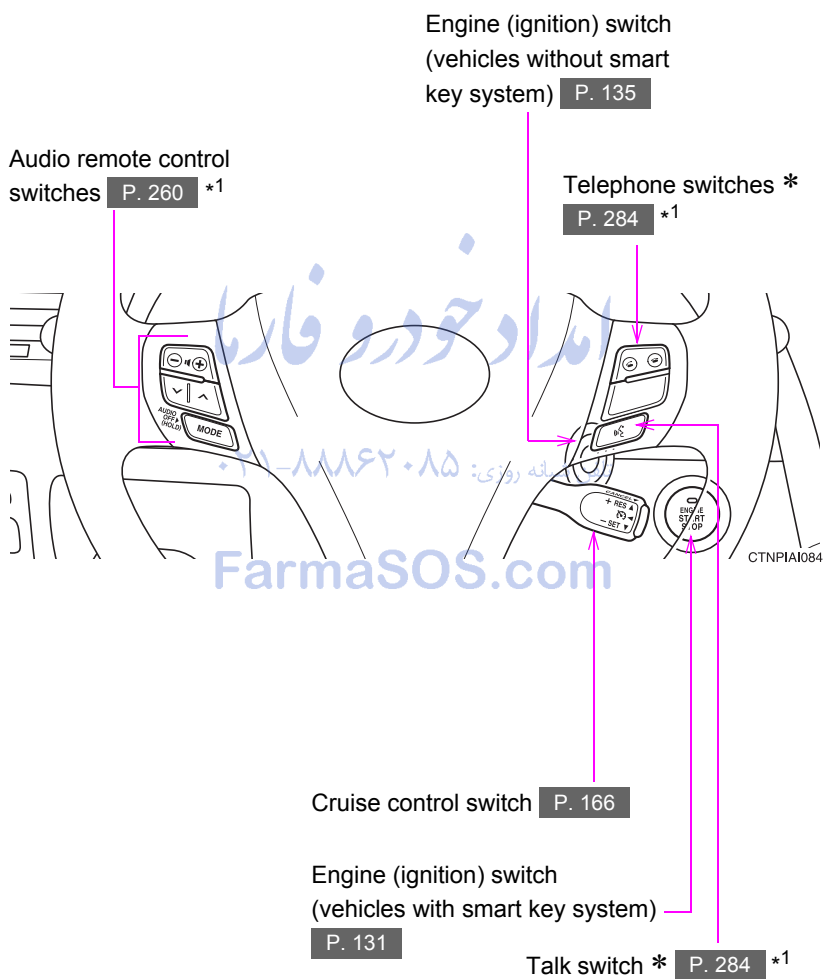

**C**

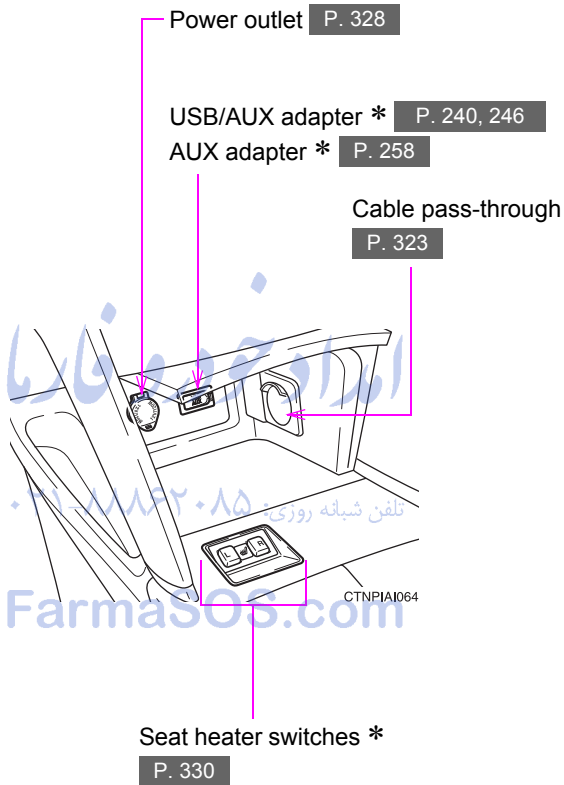

\*: If equipped

\*1: Refer to "Navigation System Owner's Manual".

# 1-1. Key information

## Keys

The following keys are provided with the vehicle.

### ► Vehicles with smart key system

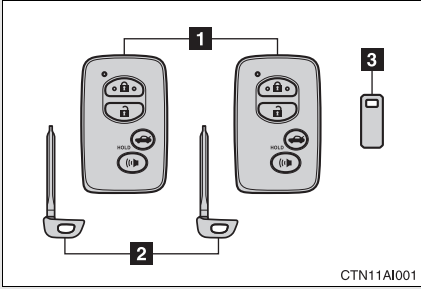

#### 1 Electronic keys

- Operating the smart key system (→P. 27)
- Operating the wireless remote control function (→P. 38)

#### 2 Mechanical keys

#### 3 Key number plate

### ► Vehicles without smart key system (type A)

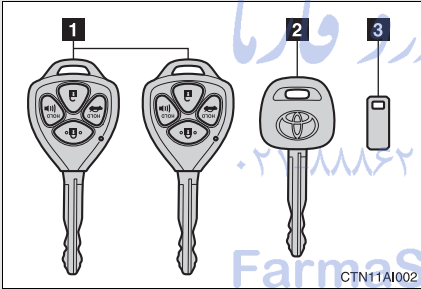

#### 1 Master keys

Operating the wireless remote control function (→P. 38)

#### 2 Valet key

#### 3 Key number plate

### ► Vehicles without smart key system (type B)

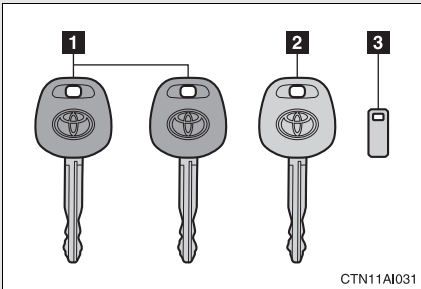

#### 1 Master keys

#### 2 Valet key

#### 3 Key number plate

## Using the mechanical key (vehicles with smart key system)

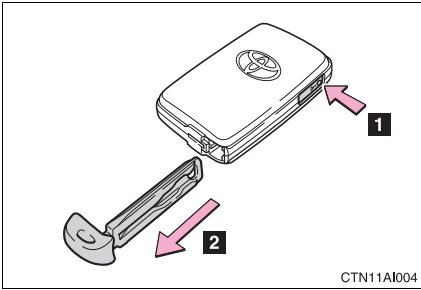

Take out the mechanical key.

After using the mechanical key, store it in the electronic key. Carry the mechanical key together with the electronic key. If the electronic key battery is depleted or the entry function does not operate properly, you will need the mechanical key. (→P. 469)

1

Before driving

### ■ When required to leave a key to the vehicle with a parking attendant

Lock the glove box and the trunk storage extension as circumstances demand. Set the luggage security system. (→P. 48, 317, 334)

Vehicles with smart key system: Remove the mechanical key for your own use and provide the attendant with the electronic key only.

Vehicles without smart key system: Carry the master key for your own use and leave the valet key only with the attendant.

### ■ Key number plate

Keep the plate in a safe place such as your wallet, not in the vehicle. In the event that a key is lost, a new key can be made by your Toyota dealer using the key number plate. (→P. 468)

### ■ When riding in an aircraft

When bringing a key with wireless remote control function onto an aircraft, make sure you do not press any buttons on the key while inside the aircraft cabin. If you are carrying the key in your bag etc, ensure that the buttons are not likely to be pressed accidentally. Pressing a button may cause the key to emit radio waves that could interfere with the operation of the aircraft.

 NOTICE

■ **To prevent key damage**

- Do not subject the keys to strong shocks, expose them to high temperatures by placing them in direct sunlight, or get them wet.
- Do not expose the keys to electromagnetic materials or attach any material that blocks electromagnetic waves to the key surface.
- Do not disassemble the key.

امداد خودرو فارما

تلفن شبانه روزی: ۰۲۱-۸۸۸۶۲۰۸۵

FarmaSOS.com



## 1-2. Opening, closing and locking the doors and trunk Smart key system\*

The following operations can be performed simply by carrying the electronic key on your person, for example in your pocket.  
(The driver should always carry the electronic key.)

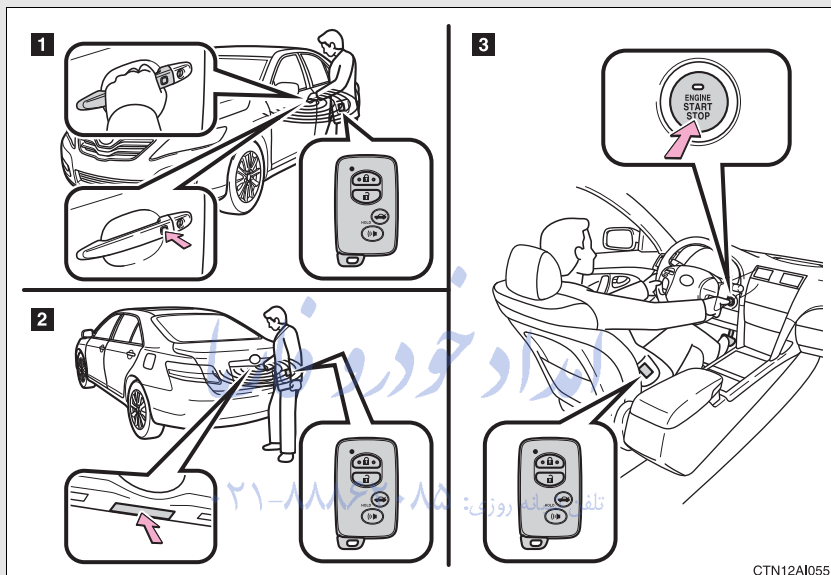

- 1** Locks and unlocks the doors (→P. 28)
- 2** Unlocks the trunk (→P. 28)
- 3** Starts the engine (→P. 131)

\*: If equipped

### Unlocking and locking the doors (front door handles only)

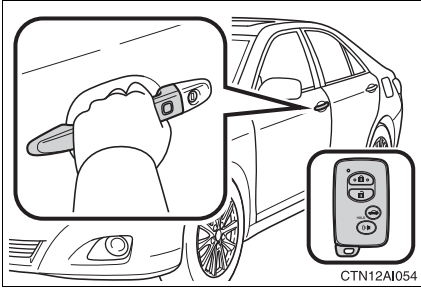

Grip the handle to unlock the door.

Make sure to touch the sensor on the back of the handle.

The door cannot be unlocked for 3 seconds after the door is locked.

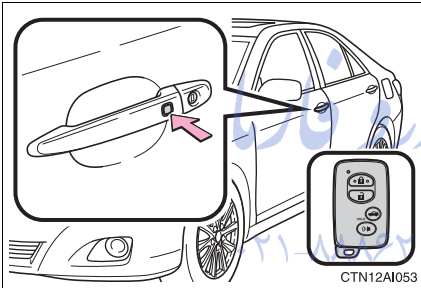

Press the lock button to lock the door.

### Unlocking the trunk

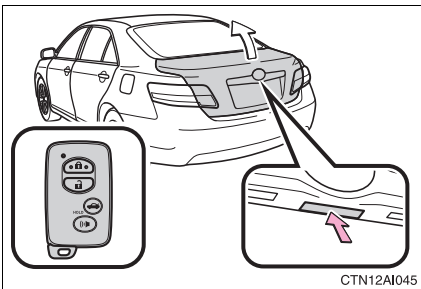

Press the button to unlock the trunk.

## Antenna location and effective range

### ■ Antenna location

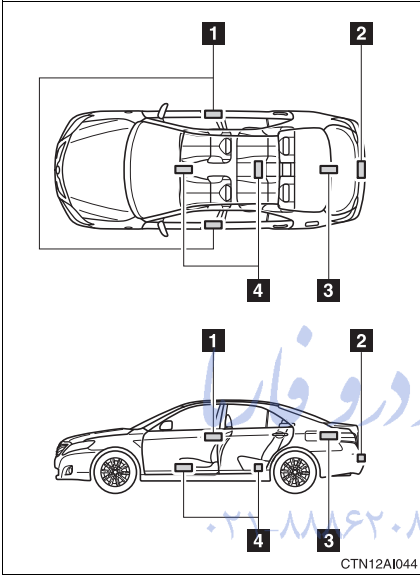

- 1 Antennas outside the cabin
- 2 Antenna outside the trunk
- 3 Antenna inside the trunk
- 4 Antennas inside the cabin

1

Before driving

FarmaSOS.com

■ **Effective range (areas within which the electronic key is detected)**

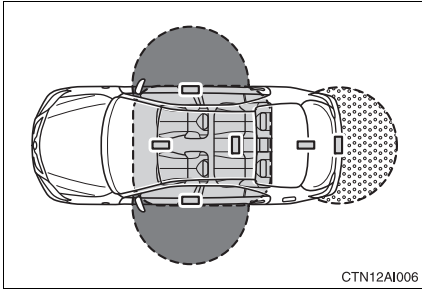

- When locking or unlocking the doors

The system can be operated when the electronic key is within about 2.3 ft. (0.7 m) of either of the outside front door handles. (Only the doors detecting the key can be operated.)

- When starting the engine or changing “ENGINE START STOP” switch modes

The system can be operated when the electronic key is inside the vehicle.

- When unlocking the trunk

The system can be operated when the electronic key is within about 2.3 ft. (0.7 m) of the trunk release button.

---

■ **Operation signals**

A buzzer sounds and the emergency flashers flash to indicate that the doors have been locked/unlocked. (Locked: Once; Unlocked: Twice)

■ **Conditions affecting operation**

The smart key system uses weak radio waves. In the following situations, the communication between the electronic key and the vehicle may be affected, preventing the smart key system and wireless remote control from operating properly. (Ways of coping: →P. 469)





- When the electronic key battery is depleted

- Near a TV tower, electric power plant, gas station, radio station, large display, airport or other facility that generates strong radio waves or electrical noise
- When carrying a portable radio, cellular phone, cordless phone or other wireless communication devices
- When the electronic key has come into contact with, or is covered by, a metallic object
- When multiple electronic keys are in the vicinity
- When carrying or using the electronic key together with the following devices that emit radio waves
  - Another vehicle's electronic key
  - A wireless key that emits radio waves
  - Personal computer
- If window tint with a metallic content or metallic objects are attached to the rear window



### ■ Switching the door unlock function

It is possible to set which doors the entry function unlocks.

**STEP 1** Turn the "ENGINE START STOP" switch OFF.

**STEP 2** When the indicator on the key surface is off, press and hold  ,  , or  for approximately 5 seconds while pressing  on the key.

The setting changes each time an operation is performed, as shown below. (When changing the setting continuously, release the buttons, wait for at least 5 seconds, and repeat step 2.)

Multi-information display	Unlocking doors	Beep
	Hold the driver's door handle to unlock only the driver's door.	Exterior: Beeps three times Interior: Pings once
	Hold the front passenger's door handle to unlock all doors	
	Hold either front door handle to unlock all doors	Exterior: Beeps twice Interior: Pings once

**STEP 3** Unlock the doors using the electronic key and open one of the doors.

If a door is not opened within 60 seconds after  is pressed, the doors will be locked again and the alarm will automatically be set. In case that the alarm is triggered, immediately stop the alarm. (→P. 82)

### ■ Battery-saving function

In the following circumstances, the entry function is disabled in order to prevent the vehicle and electronic key batteries from discharging.

- When the entry function has not been used for 2 weeks or more
- When the electronic key has been left within approximately 6 ft. (2 m) of the vehicle for 10 minutes or more

The system will resume operation when...

- The vehicle is locked using the door handle lock switch.
- The vehicle is locked/unlocked using the wireless remote control function. (→P. 38)
- The vehicle is locked/unlocked using the mechanical key. (→P. 469)

### ■ Electronic key battery depletion

- The standard battery life is 1 to 2 years. (The battery becomes depleted even if the electronic key is not used.) If the smart key system or the wireless remote control function does not operate, or the detection area becomes smaller, the battery may be depleted. Replace the battery when necessary. (→P. 401)
- To avoid serious deterioration, do not leave the electronic key within 3 ft. (1 m) of the following electrical appliances that produce a magnetic field.
  - TVs
  - Personal computers
  - Recharging cellular phones or cordless phones
  - Table lamps

### ■ To operate the system properly

Make sure to carry the electronic key when operating the system. Do not get the electronic key too close to the vehicle when operating the system from the outside of the vehicle.

Depending on the position and holding condition of the electronic key, the key may not be detected correctly and the system may not operate properly. (The alarm may go off accidentally, or the door lock prevention may not function.)

### ■ Note for the smart key system

- Even when the electronic key is within the effective range (detection areas), the system may not operate properly in the following cases.
  - The electronic key is too close to the window or outside door handle, near the ground, or in a high place when the doors are locked or unlocked.
  - The electronic key is near the ground or in a high place, or too close to the rear bumper center when the trunk is unlocked.
  - The electronic key is on the instrument panel, package tray, floor, or in the auxiliary box of the driver's side instrument panel or glove box when the engine is started or "ENGINE START STOP" switch modes are changed.
- As long as the electronic key is within the effective range, the doors may be locked or unlocked by anyone.
- Even if the electronic key is not inside the vehicle, it may be possible to start the engine if the electronic key is near the window.
- The doors may unlock if a large amount of water splashes on the door handle, such as in the rain or in a car wash. (The doors will automatically be locked after approximately 60 seconds if the doors are not opened and closed.)
- Gripping the door handle when wearing a glove may not unlock the door.
- If the wireless remote control is used to lock the doors when the electronic key is near the vehicle, there is a possibility that the door may not be unlocked by the entry function. (Use the wireless remote control to unlock the doors.)
- A sudden approach to the effective range or door handle may prevent the doors from being unlocked. In this case, return the door handle to the original position and check that the doors unlock before pulling the door handle again.

### ■ When the vehicle is not driven for extended periods

To prevent theft of the vehicle, do not leave the electronic key within 6 ft. (2 m) of the vehicle.

### ■ Security feature

If a door is not opened within approximately 60 seconds after the vehicle is unlocked, the security feature automatically locks the vehicle again.

■ Alarms and warning indicators

A combination of exterior and interior alarms as well as warning messages shown on the multi-information display are used to reduce the chance of vehicle theft and accidents resulting from erroneous operation.

- When any warning lights come on:  
Take appropriate measures according to which warning light comes on. (→P. 432)
- When a warning message is shown on the multi-information display (vehicles with Optitron type meters):  
Take appropriate measures according to the warning message on the multi-information display. (→P. 444)

The following table describes circumstances and correction procedures when only alarms are sounded.

Alarm	Situation	Correction procedure
Exterior alarm sounds once for 2 seconds	Tried to lock the doors using the entry function while the electronic key is still inside the passenger compartment	Retrieve the electronic key from the passenger compartment and lock the doors again.
	Closed the trunk while the electronic key is still inside the trunk and all doors are locked	Retrieve the electronic key from the trunk and close the trunk lid.
Exterior alarm sounds once for 10 seconds	Tried to lock the vehicle using the entry function while a door is open	Close all of the doors and lock the doors again.



Alarm	Situation	Correction procedure
Exterior alarm sounds once for 60 seconds	Tried to exit the vehicle with the electronic key and lock the doors without first turning the "ENGINE START STOP" switch OFF	Turn the "ENGINE START STOP" switch OFF and lock the doors again.
Interior alarm sounds continuously	Tried to open the door and exit the vehicle without shifting the shift lever to P when the "ENGINE START STOP" switch is in ACCESSORY mode or IGNITION ON mode	Shift the shift lever to P.
Interior alarm beeps repeatedly	Turned the "ENGINE START STOP" switch to ACCESSORY mode while the driver's door is open (Opened the driver's door when the "ENGINE START STOP" switch is in ACCESSORY mode.)	Turn the "ENGINE START STOP" switch OFF and close the driver's door.
	Turned the "ENGINE START STOP" switch OFF while the driver's door is open	Close the driver's door.

■ **If the smart key system does not operate properly**

- Locking and unlocking the doors and trunk: Use the mechanical key. (→P. 469)
- Starting the engine: →P. 470

■ **When the electronic key battery is fully depleted**

→P. 401

■ **Customization that can be configured at Toyota dealer**

It is possible to deactivate the smart key system, etc.  
(Customizable features →P. 510)

### ■ Certification for the smart key system

► For vehicles sold in the U.S.A.

FCC ID: NI4TMLF-3

#### NOTE:

This device complies with Part 15 of the FCC Rules. Operation is subject to the following two conditions: (1) This device may not cause harmful interference, and (2) this device must accept any interference received, including interference that may cause undesired operation.

#### NOTICE:

This equipment has been tested and found to comply with the limits for a Class B digital device, pursuant to Part 15 of the FCC Rules. These limits are designed to provide reasonable protection against harmful interference in a residential installation. This equipment generates, uses and can radiate radio frequency energy and, if not installed and used in accordance with the instructions, may cause harmful interference to radio communications. However, there is no guarantee that interference will not occur in a particular installation. If this equipment does cause harmful interference to radio or television reception, which can be determined by turning the equipment off and on, the user is encouraged to try to correct the interference by one or more of the following measures:

- Reorient or relocate the receiving antenna.
- Increase the separation between the equipment and receiver.
- Connect the equipment into an outlet on a circuit different from that to which the receiver is connected.
- Consult the dealer or an experienced radio/TV technician for help.

#### FCC WARNING:

Changes or modifications not expressly approved by the party responsible for compliance could void the user's authority to operate the equipment.

► For vehicles sold in Canada

#### NOTE:

Operation is subject to the following two conditions: (1) This device may not cause interference, and (2) this device must accept any interference, including interference that may cause undesired operation of the device.

**⚠ CAUTION**

**■ Caution regarding interference with electronic devices**

- People with implanted pacemakers or cardiac defibrillators should keep away from the smart key system antennas. (→P. 29)

The radio waves may affect the operation of such devices. If necessary, the entry function can be disabled. Ask your Toyota dealer for details, such as the frequency of radio waves and timing of emitting the radio waves. Then, consult your doctor to see if you should disable the entry function.

- User of any electrical medical device other than implanted pacemakers and implanted cardiac defibrillators should consult the manufacturer of the device for information about its operation under the influence of radio waves.

Radio waves could have unexpected effects on the operation of such medical devices.

Ask your Toyota dealer for details for disabling the entry function.

تلفن شبانه روزی: ۰۲۱-۸۸۶۲۰۸۵

FarmaSOS.com

## 1-2. Opening, closing and locking the doors and trunk Wireless remote control\*

The wireless remote control can be used to lock and unlock the vehicle from outside the vehicle.

### ► Vehicles with smart key system

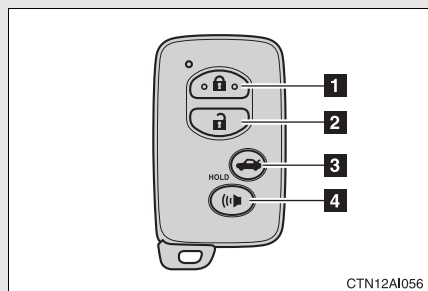

- 1 Locks all doors
- 2 Unlocks all doors

Pressing the button unlocks the driver's door. Pressing the button again within 3 seconds unlocks the other doors.

- 3 Unlocks the trunk (press and hold)
- 4 Sounds an alarm (press and hold)

### ► Vehicles without smart key system

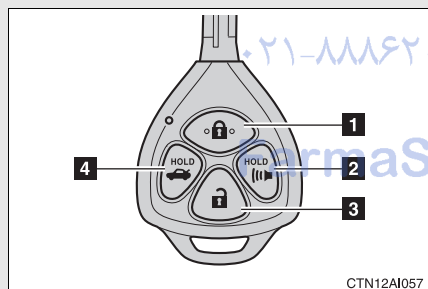

- 1 Locks all doors
- 2 Sounds an alarm (press and hold)
- 3 Unlocks all doors

Pressing the button unlocks the driver's door. Pressing the button again within 3 seconds unlocks the other doors.

- 4 Unlocks the trunk (press and hold)

\*: If equipped

## ■ Operation signals

**Doors:** A buzzer sounds and the emergency flashers flash to indicate that the doors have been locked/unlocked.

(Locked: Once; Unlocked: Twice)

**Trunk:** A buzzer sounds to indicate that the trunk has been unlocked.

## ■ Door lock buzzer

If a door is not fully closed, a buzzer sounds continuously for 10 seconds if an attempt to lock the door is made. Fully close the door to stop the buzzer, and lock the vehicle once more.

## ■ Panic mode

### ► Vehicles with smart key system

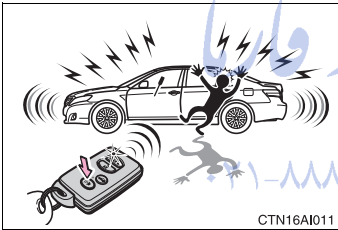

When  is pressed for longer than about one second, an alarm will sound intermittently and the vehicle lights will flash to deter any person from trying to break into or damage your vehicle.

To stop the alarm, press any button on the electronic key.

### ► Vehicles without smart key system

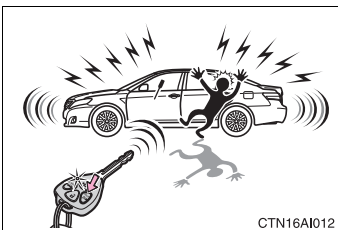

When  is pressed for longer than about one second, an alarm will sound intermittently and the vehicle lights will flash to deter any person from trying to break into or damage your vehicle.

To stop the alarm, press any button on the wireless remote control.

### ■ Key battery depletion

- ▶ Vehicles with smart key system

→P. 32

- ▶ Vehicles without smart key system

The standard battery life is 1 to 2 years. (The battery becomes depleted even if the key is not used.) If the wireless remote control function does not operate, the battery may be depleted. Replace the battery when necessary. (→P. 401)

### ■ Security feature

If a door is not opened within approximately 60 seconds after the vehicle is unlocked, the security feature automatically locks the vehicle again.

### ■ When the electronic key battery is fully depleted (vehicles with smart key system)

→P. 401

### ■ Conditions affecting operation

- ▶ Vehicles with smart key system

→P. 30

- ▶ Vehicles without smart key system

The wireless remote control function may not operate normally in the following situations.

- Near a TV tower, radio station, electric power plant, airport or other facility that generates strong radio waves
- When carrying a portable radio, cellular phone or other wireless communication devices
- When multiple wireless keys are in the vicinity
- When the wireless key has come into contact with, or is covered by, a metallic object
- When a wireless key (that emits radio waves) is being used nearby
- When the wireless key has been left near an electrical appliance such as a personal computer

### ■ Customization that can be configured at Toyota dealer

Settings (e.g. trunk unlocking function) can be changed.  
(Customizable features →P. 510)

### ■ Certification for wireless remote control

► For vehicles sold in the U.S.A.

#### NOTE:

This device complies with Part 15 of the FCC Rules. Operation is subject to the following two conditions: (1) this device may not cause harmful interference, and (2) this device must accept any interference received, including interference that may cause undesired operation.

#### NOTICE:

This equipment has been tested and found to comply with the limits for a Class B digital device, pursuant to Part 15 of the FCC Rules. These limits are designed to provide reasonable protection against harmful interference in a residential installation. This equipment generates, uses and can radiate radio frequency energy and, if not installed and used in accordance with the instructions, may cause harmful interference to radio communications. However, there is no guarantee that interference will not occur in a particular installation. If this equipment does cause harmful interference to radio or television reception, which can be determined by turning the equipment off and on, the user is encouraged to try to correct the interference by one or more of the following measures:

- Reorient or relocate the receiving antenna.
- Increase the separation between the equipment and receiver.
- Connect the equipment into an outlet on a circuit different from that to which the receiver is connected.
- Consult the dealer or an experienced radio/TV technician for help.

#### FCC WARNING:

Changes or modifications not expressly approved by the party responsible for compliance could void the user's authority to operate the equipment.

► For vehicles sold in Canada

#### NOTE:

Operation is subject to the following two conditions: (1) this device may not cause interference, and (2) this device must accept any interference, including interference that may cause undesired operation of the device.

## 1-2. Opening, closing and locking the doors and trunk

### Doors

The vehicle can be locked and unlocked using the entry function, wireless remote control, key or door lock switch.

#### ■ Entry function (vehicles with smart key system)

→P. 27

#### ■ Wireless remote control (if equipped)

→P. 38

#### ■ Key

##### ▶ Vehicles with smart key system

The doors can also be locked and unlocked with the mechanical key. (→P. 469)

##### ▶ Vehicles without smart key system

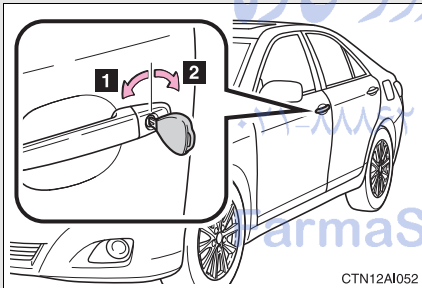

1 Locks all doors

2 Unlocks all doors

Turning the key unlocks the driver's door. Turning the key again unlocks the other doors.

#### ■ Door lock switch

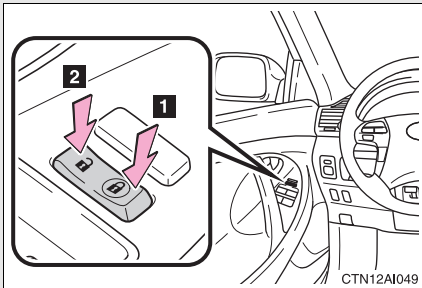

1 Locks all doors

2 Unlocks all doors



■ Inside lock button

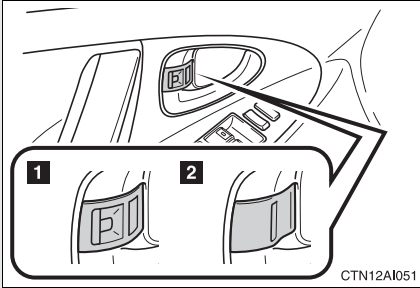

- 1 Unlocks the door
- 2 Locks the door

The front doors can be opened by pulling the inside handle even if the lock buttons are in the lock position.

1

Before driving

**Locking the front doors from the outside without a key**

- ▶ Vehicles with smart key system

The door cannot be locked if the “ENGINE START STOP” switch is in ACCESSORY or IGNITION ON mode, or the electronic key is left inside the vehicle.

Depending on the position of the electronic key, the key may not be detected correctly and the door may be locked.

- ▶ Vehicles without smart key system

The door cannot be locked if either of the front doors is open and the key is in the engine switch.

**Rear door child-protector lock**

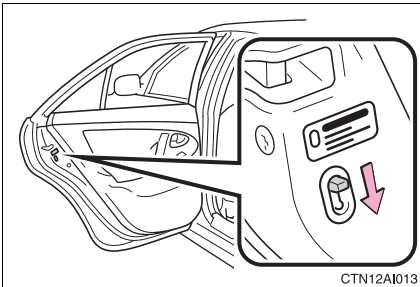

The door cannot be opened from inside the vehicle when the locks are set.

These locks can be set to prevent children from opening the rear doors. Push down on each rear door switch to lock both rear doors.

## Automatic door locking and unlocking systems

The following functions can be set or cancelled:

Function	Operation
Shift position linked door locking function *	Shifting the shift lever out of P locks all doors.
Shift position linked door unlocking function *	Shifting the shift lever to P unlocks all doors.
Speed linked door locking function	All doors are locked when the vehicle speed is approximately 12 mph (20 km/h) or higher.
Driver's door linked door unlocking function	<ul style="list-style-type: none"> <li>▶ Vehicles with smart key system All doors are unlocked when the driver's door is opened within 10 seconds after turning the "ENGINE START STOP" switch OFF.</li> <li>▶ Vehicles without smart key system All doors are unlocked when the driver's door is opened within 10 seconds after turning the engine switch from the "ON" position to the "ACC" or "LOCK" position.</li> </ul>

\*: Vehicles with an automatic transmission only

### ■ Setting and canceling the functions

To switch between setting and canceling, follow the procedure below:



#### STEP 1 Vehicles with smart key system:

Close all the doors and switch the “ENGINE START STOP” switch to IGNITION ON mode. (Perform the step 2 within 20 seconds.)

Vehicles without smart key system:

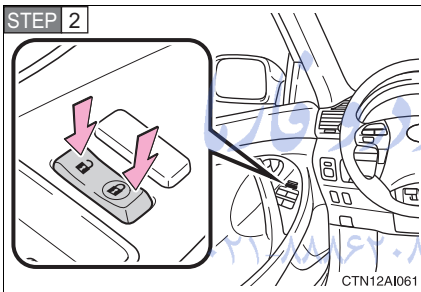



Close all the doors and switch the engine switch to the “ON” position. (Perform step 2 within 10 seconds.)



Shift the shift lever to P or N, and press and hold the driver's door lock switch (  or  ) for approximately 5 seconds and then release.

The shift lever and switch positions corresponding to the desired function to be set are shown as follows.

**FarmaSOS** Use the same procedure to cancel the function.

Function	Shift lever position	Driver's door lock switch position
Shift position linked door locking function*	P	
Shift position linked door unlocking function*		
Speed linked door locking function	N	
Driver's door linked door unlocking function		

\*: Vehicles with an automatic transmission only

When the setting or canceling operation is complete, all doors are locked and then unlocked.

---

■ **Customization that can be configured at Toyota dealer**

Settings (e.g. unlocking function using a key) can be changed.  
(Customizable features →P. 510)

**⚠ CAUTION**

■ **To prevent an accident**

Observe the following precautions while driving the vehicle.

Failing to do so may result in a door opening and an occupant falling out, resulting in death or serious injury.

- Always use a seat belt.
- Always lock the doors.
- Ensure that all doors are properly closed.
- Do not pull the inside handle of the doors while driving.

The doors may be opened and the passengers are thrown out of the vehicle and it may result in serious injury or death.

Be especially careful for the front doors, the doors may be opened even if the inside lock buttons are in locked position.

- Set the rear door child protector locks when children are seated in the rear seat.

## 1-2. Opening, closing and locking the doors and trunk

### Trunk

The trunk can be opened using the key, trunk opener, entry function or wireless remote control.

#### ■ Opening the trunk from outside the vehicle

##### ▶ Entry function (vehicles with smart key system)

→P. 27

##### ▶ Wireless remote control (if equipped)

→P. 38

##### ▶ Key (vehicles with smart key system)

The trunk can be opened using the mechanical key. (→P. 469)

##### ▶ Key (vehicles without smart key system)

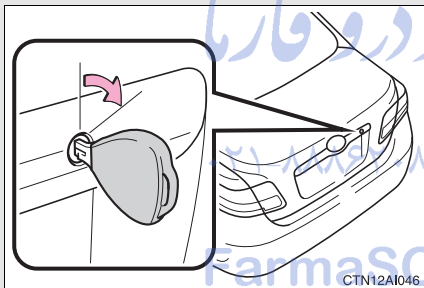

Turn the master key clockwise to release the trunk lid.

#### ■ Opening the trunk from inside the vehicle

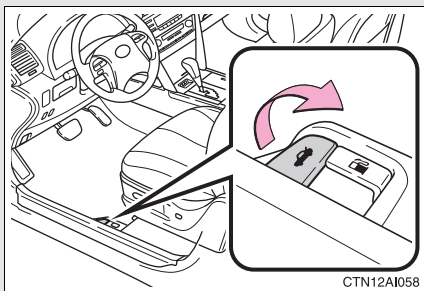

Pull the lever to release the trunk lid.

## Luggage security system

To protect luggage stored in the trunk against theft, do the following procedure.

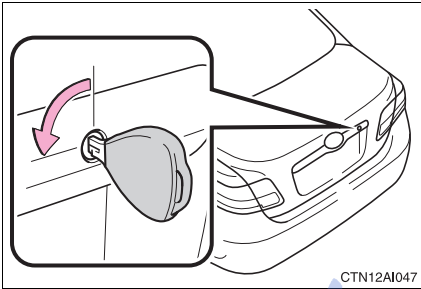

Turn the master key (vehicles without smart key system) or mechanical key (vehicles with smart key system) counterclockwise to lock the trunk opener feature.

The trunk lid cannot be opened even with the wireless remote control or the entry function.

### Internal trunk release lever

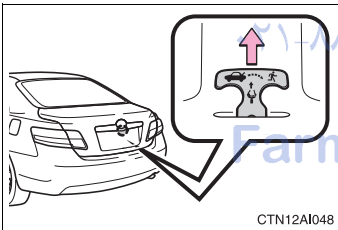

The trunk lid can be opened by pulling up the glow-in-the-dark lever located on the inside of trunk lid.

The lever will continue to glow for some time after the trunk lid is closed.

### Trunk light

The trunk light turns on when the trunk is opened.

- Which key to the vehicle is to leave with a parking attendant after the luggage security system is set. →P. 25

 CAUTION

**■ Caution while driving**

- Keep the trunk lid closed while driving.

If the trunk lid is left open, it may hit near-by objects while driving or luggage in the trunk may be unexpectedly thrown out, causing an accident.

In addition, exhaust gases may enter the vehicle, causing death or a serious health hazard. Make sure to close the trunk lid before driving.

- Before driving the vehicle, make sure that the trunk lid is fully closed. If the trunk lid is not fully closed, it may open unexpectedly while driving, causing an accident.
- Never let anyone sit in the trunk. In the event of sudden braking or a collision, they are susceptible to death or serious injury.

**■ When children are in the vehicle**

Observe the following precautions.

Failure to do so may result in death or serious injury.

- Do not allow children to enter the trunk.

If a child is accidentally locked in the trunk, they could overheat or suffocate.

- Do not allow a child to open or close the trunk lid.

Doing so may cause the trunk lid to operate unexpectedly, or cause the child's hands, head, or neck to be caught by the closing trunk lid.

**⚠ CAUTION**

**■ Using the trunk**

Observe the following precautions.

Failure to do so may cause parts of the body to be caught, resulting in serious injury.

- Remove any heavy loads, such as snow and ice, from the trunk lid before opening it. Failure to do so may cause the trunk lid to fall closed again after it is opened.
- When opening or closing the trunk lid, thoroughly check to make sure the surrounding area is safe.
- If anyone is in the vicinity, make sure they are safe and let them know that the trunk is about to open or close.
- Use caution when opening or closing the trunk lid in windy weather as it may move abruptly in strong wind.

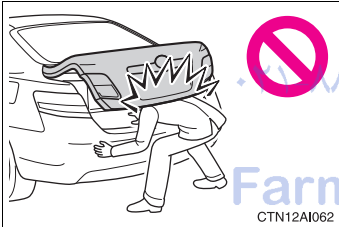

- The trunk lid may fall if it is not opened fully. It is more difficult to open or close the trunk lid on an incline than on a level surface, so beware of the trunk lid unexpectedly opening or closing by itself. Make sure that the trunk lid is fully open and secure before using the trunk.

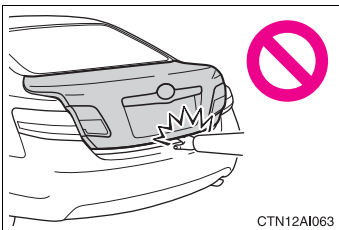

- When closing the trunk lid, take extra care to prevent your fingers etc. from being caught.
- When closing the trunk lid, make sure to press it lightly on its outer surface.

- Do not attach any accessories other than genuine Toyota parts to the trunk lid. Such additional weight on the trunk lid may cause the lid to fall closed again after it is opened.



## 1-3. Adjustable components (seats, mirrors, steering wheel)

### Front seats

#### ► Power seat

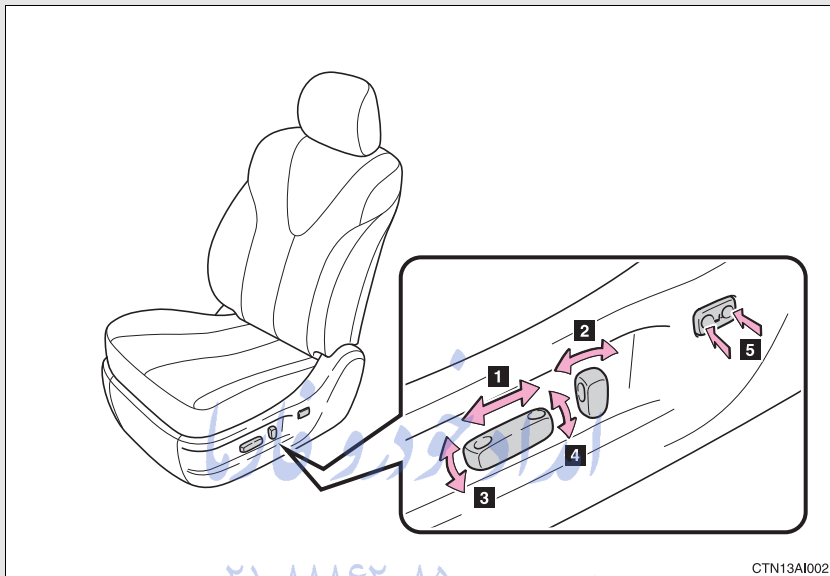

- 1** Seat position switch
- 2** Seatback angle switch
- 3** Seat cushion (front) angle switch (driver's side only)
- 4** Vertical height adjustment switch (driver's side only)
- 5** Lumbar support switch (driver's side only)

► Manual seat

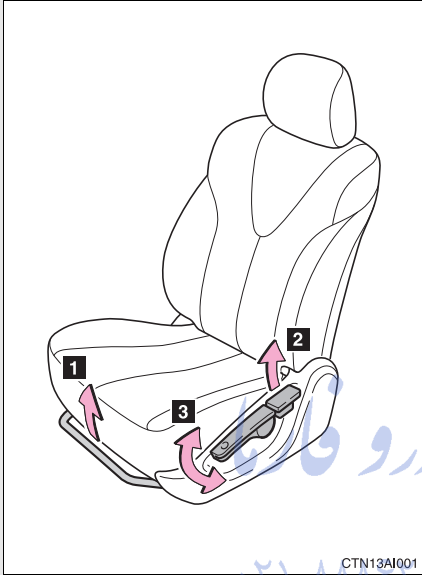

- 1** Seat position adjustment lever
- 2** Seatback angle adjustment lever
- 3** Vertical height adjustment lever (driver's side only)

**! CAUTION**

FarmaSOS.com

■ **Seat adjustment**

- Do not recline the seat more than necessary when the vehicle is in motion to reduce the risk of sliding under the lap belt.  
If the seat is too reclined, the lap belt may slide past the hips and apply restraint forces directly to the abdomen or your neck may contact the shoulder belt, increasing the risk of death or serious injury in the event of an accident.
- Manual seat only: After adjusting the seat, make sure that the seat is locked in position.

## 1-3. Adjustable components (seats, mirrors, steering wheel)

### Rear seats

#### ■ Adjusting the rear seat (if equipped)

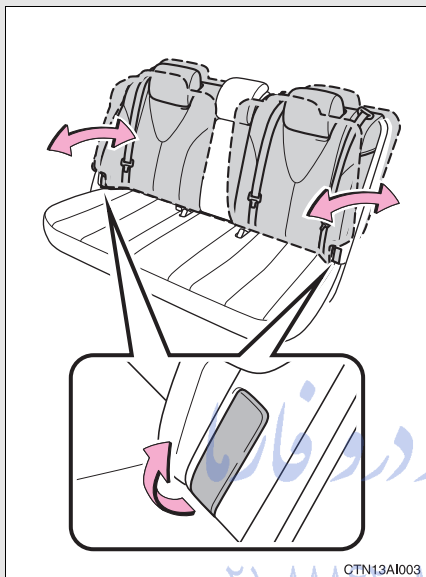

Pull up the seatback angle adjustment lever until the lock is completely released.

1

Before driving

CTN13A1003  
تلفن شبانه روزی: ۰۲۱-۸۸۸۶۱۰۸۵

FarmaSOS.com

### ■ Folding down rear seatbacks (if equipped)

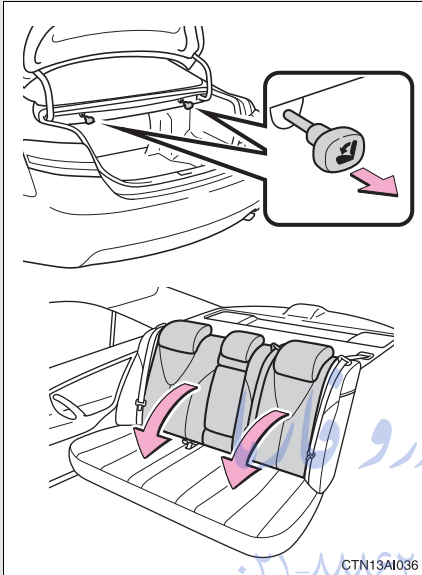

Pull the seatback lever in the trunk for the seatback you wish to fold down.

### ⚠ CAUTION

FarmaSOS.com

#### ■ After returning the seatback to the upright position

Observe the following precautions. Failure to do so may result in death or serious injury.

- Make sure the seatback is securely locked by pressing forward and rearward on the top of the seatback.
- Check that the seat belts are not twisted or caught in the seatback.

### ⚠ NOTICE

#### ■ When right seatback is folded down

Make sure the luggage loaded in the enlarged trunk will not damage the webbing of the rear center seat belt.

# 1-3. Adjustable components (seats, mirrors, steering wheel)

## Head restraints

Head restraints are provided for all seats.

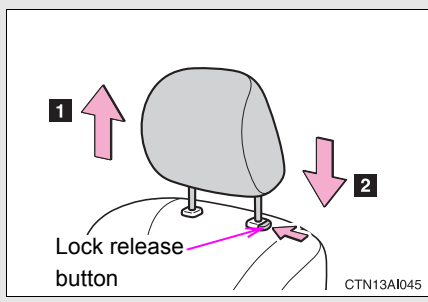

### 1 Up

Pull the head restraints up.

### 2 Down

Push the head restraint down while pushing the lock release button.

1

Before driving

### ■ Removing the head restraints

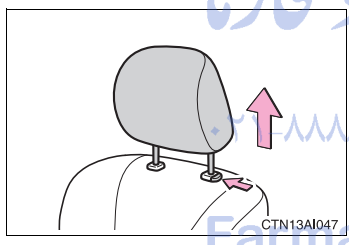

Pull the head restraint up while pressing the lock release button.

### ■ Installing the head restraints

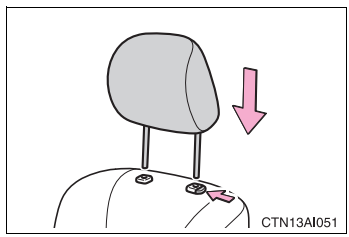

Align the head restraint with the installation holes and push it down to the lock position.

Press and hold the lock release button when lowering the head restraint.

ایراد خود و فارما  
تلفن شبانه روزی: ۰۲۱۸۸۶۲۰۸۵  
FarmaSOS.com

### ■ Adjusting the height of the head restraints

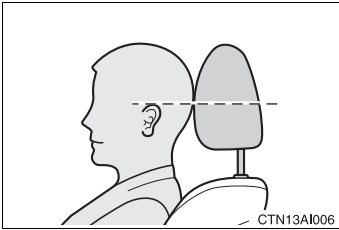

Make sure that the head restraints are adjusted so that the center of the head restraint is closest to the top of your ears.

### ■ Adjusting the rear center seat head restraint

Always raise the head restraint one level from the stowed position when using.

#### ⚠ CAUTION

#### ■ Head restraint precautions

Observe the following precautions regarding the head restraints. Failure to do so may result in death or serious injury.

- Use the head restraints designed for each respective seat.
- Adjust the head restraints to the correct position at all times.
- After adjusting the head restraints, push down on them and make sure they are locked in position.
- Do not drive with the head restraints removed.

## 1-3. Adjustable components (seats, mirrors, steering wheel)

### Seat belts

Make sure that all occupants are wearing their seat belts before driving the vehicle.

#### ■ Correct use of the seat belts

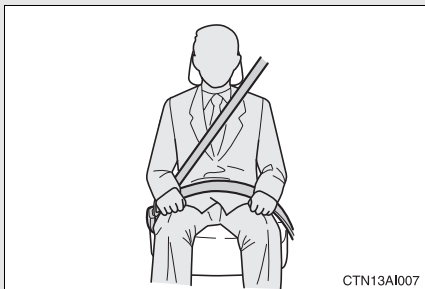

- Extend the shoulder belt so that it comes fully over the shoulder, but does not come into contact with the neck or slide off the shoulder.
- Position the lap belt as low as possible over the hips.
- Adjust the position of the seatback. Sit up straight and well back in the seat.
- Do not twist the seat belt.

#### ■ Fastening and releasing the seat belt

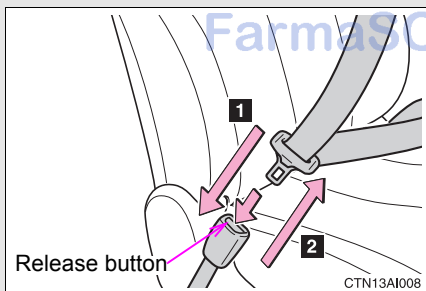

- 1** Fastening the belt  
Push the tab into the buckle until a clicking sound is heard.
- 2** Releasing the belt  
Press the release button.

### ■ Adjusting the height of the belt (front seats)

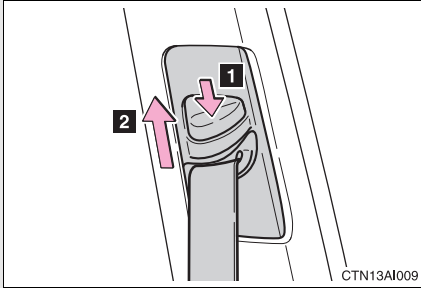

**1** Down

**2** Up

Move the height adjuster up and down as needed until you hear a click.

### Seat belt comfort guide (outside rear seat)

If the shoulder belt fits close to a person's neck, use the seat belt comfort guide.

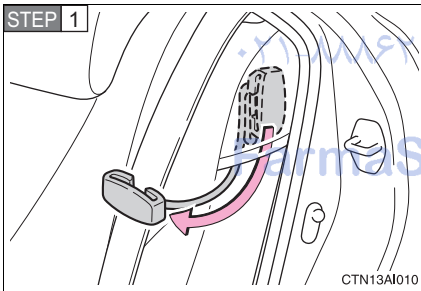

Pull out the comfort guide from the pocket.

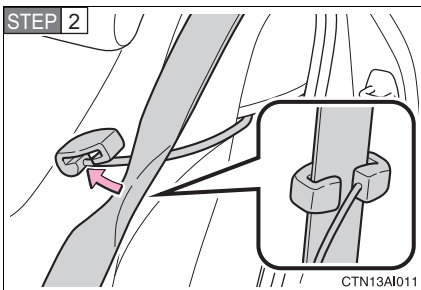

Slide the belt past the slot of the guide.

The elastic cord must be behind the seat belt.



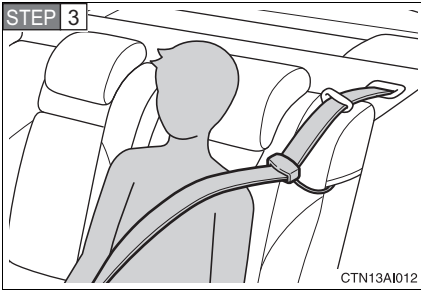

Buckle, position and release the seat belt.

### Seat belt pretensioners (front seats)

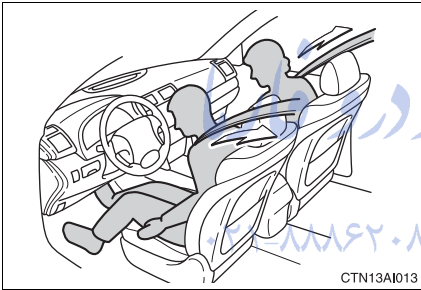

The pretensioner helps the seat belt to quickly restrain the occupant by retracting the seat belt when the vehicle is subjected to certain types of severe frontal collision.

The pretensioner may not activate in the event of a minor frontal impact, a side impact or a rear impact.

FarmaSOS.com

■ **Emergency locking retractor (ELR)**

The retractor will lock the belt during a sudden stop or on impact. It may also lock if you lean forward too quickly. A slow, easy motion will allow the belt to extend so that you can move around fully.

■ **Automatic locking retractor (ALR)**

When a passenger's shoulder belt is completely extended and then retracted even slightly, the belt is locked in that position and cannot be extended. This feature is used to hold the child restraint system (CRS) firmly. To free the belt again, fully retract the belt and then pull the belt out once more. (→P. 108)

■ **Pregnant women**

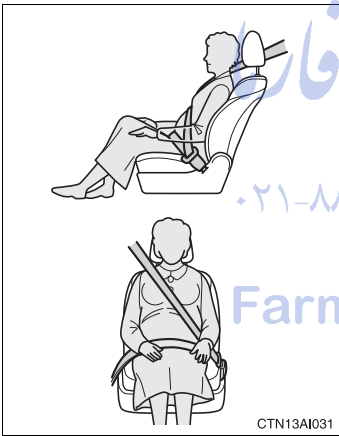

Obtain medical advice and wear the seat belt in the proper way. (→P. 57)

Women who are pregnant should position the lap belt as low as possible over the hips in the same manner as other occupants. Extend the shoulder belt completely over the shoulder and position the belt across the chest. Avoid belt contact over the rounding of the abdominal area.

If the seat belt is not worn properly, not only a pregnant woman, but also the fetus could suffer death or serious injury as a result of sudden braking or a collision.

■ **People suffering illness**

Obtain medical advice and wear the seat belt in the proper way.

### ■ Child seat belt usage

The seat belts of your vehicle were principally designed for persons of adult size.

- Use a child restraint system appropriate for the child, until the child becomes large enough to properly wear the vehicle's seat belt. (→P. 104)
- When the child becomes large enough to properly wear the vehicle's seat belt, follow the instructions on P. 57 regarding seat belt usage.

### ■ Replacing the belt after the pretensioner has been activated

If the vehicle is involved in multiple collisions, the pretensioner will activate for the first collision, but will not activate for the second or subsequent collisions.

### ■ Seat belt extender

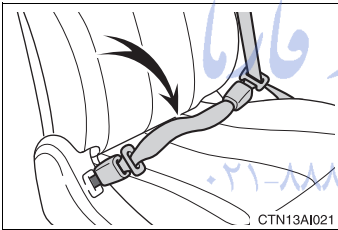

If your seat belts cannot be fastened securely because they are not long enough, a personalized seat belt extender is available from your Toyota dealer free of charge.

تلفن شبانه روزی: ۰۲۱-۸۸۸۶۲۰۸۵

### ■ Rear seat belt

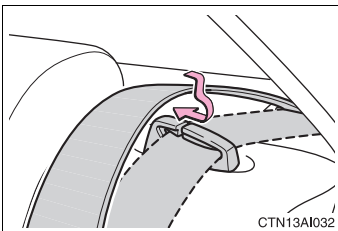

Use the seat belt after passing it through the guide if the seat belt comes free from the guide.

FarmaSOS.com

 CAUTION

Observe the following precautions to reduce the risk of injury in the event of sudden braking, sudden swerving or an accident. Failing to do so may cause death or severe injury.

■ **Wearing a seat belt**

- Ensure that all passengers wear a seat belt.
- Always wear a seat belt properly.
- Each seat belt should be used by one person only. Do not use a seat belt for more than one person at once, including children.
- Toyota recommends that children be seated in the rear seat and always use a seat belt and/or an appropriate child restraint system.
- Do not recline the seat any more than necessary to achieve a proper seating position. The seat belt is most effective when the occupants are sitting up straight and well back in the seats.
- Do not wear the shoulder belt under your arm.
- Always wear your seat belt low and snug across your hips.

■ **Adjustable shoulder anchor**

Always make sure the shoulder belt is positioned across the center of your shoulder. The belt should be kept away from your neck, but not falling off your shoulder. Failure to do so could reduce the amount of protection in an accident and cause death or serious injuries in the event of a sudden stop, sudden swerve or collision. (→P. 58)

■ **Seat belt pretensioners**

- Do not place anything, such as a cushion, on the front passenger's seat. Doing so will disperse the passenger's weight, which prevents the sensor from detecting the passenger's weight properly. As a result, the seat belt pretensioner for the front passenger's seat may not activate in the event of a collision.
- If the pretensioner has activated, the seat belt becomes locked: it cannot be further extended, nor will it return to the stowed position. The seat belt cannot be used again and must be replaced at your Toyota dealer.

 **CAUTION****■ Child restraint lock function belt precaution**

Do not allow children to play with the child restraint lock function belt. If the belt becomes twisted around a child's neck, it will not be possible to pull the belt out leading to choking or other serious injuries that could result in death. If this occurs and the buckle cannot be unfastened, scissors should be used to cut the belt.

**■ Seat belt damage and wear**

- Do not damage the seat belts by allowing the belt, plate, or buckle to be jammed in the door.
- Inspect the seat belt system periodically. Check for cuts, fraying, and loose parts. Do not use a damaged seat belt until it is replaced. Damaged seat belts cannot protect an occupant from death or serious injury.
- Ensure that the belt and tab are locked and the belt is not twisted. If the seat belt does not function correctly, immediately contact your Toyota dealer.
- Replace the seat assembly, including the belts, if your vehicle has been involved in a serious accident, even if there is no obvious damage.
- Do not attempt to install, remove, modify, disassemble or dispose of the seat belts. Have any necessary repairs carried out by your Toyota dealer. Inappropriate handling of the pretensioner may prevent it from operating properly resulting in death or serious injury.
- Always make sure the shoulder belt passes through the guide when using the seat belt. Failure to properly position the belt may reduce the amount of protection in an accident and could lead to serious injuries in a collision or sudden stop.
- Always make sure that the seat belt is not twisted, does not get caught in the guide or the seatback and is arranged in the proper position.

 CAUTION

■ **Using a seat belt comfort guide**

- Make sure the belt is not twisted and that it lies flat. The elastic cord must be behind the belt and the guide must be on the front.
- To reduce the chance of injury in case of a sudden stop, sudden swerve or accident while driving, remove and store the comfort guide in its pocket when it is not in use.
- Always make sure the shoulder belt is positioned across the center of the shoulder. The belt should be kept away from the neck, and should not fall off the shoulder.  
Failure to observe these precautions could reduce the effectiveness of the seat belt in an accident, causing death or serious injury.

■ **Using a seat belt extender**

- Do not wear the seat belt extender if you can fasten the seat belt without the extender.
- Do not use the seat belt extender when installing a child restraint system because the belt will not securely hold the child restraint system, increasing the risk of death or serious injury in the event of an accident.
- The personalized extender may not be safe on another vehicle, when used by another person, or at a different seating position other than the one originally intended.

 NOTICE

■ **When using a seat belt extender**

When releasing the seat belt, press on the buckle release button on the extender, not on the seat belt.

This helps prevent damage to the vehicle interior and the extender itself.

## 1-3. Adjustable components (seats, mirrors, steering wheel)

### Steering wheel

The steering wheel can be adjusted to a comfortable position.

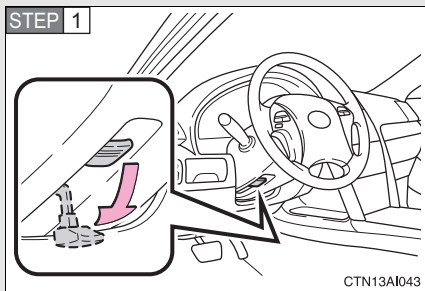

Hold the steering wheel and press the lever down.

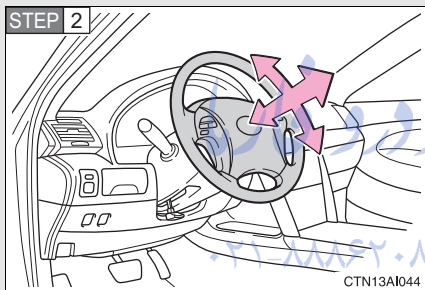

Adjust to the ideal position by moving the steering wheel horizontally and vertically.

After adjustment, pull the lever up to secure the steering wheel.

تلفن شبانه روزی: ۰۲۱۸۸۸۶۲۰۸۵

#### ⚠ CAUTION

##### ■ Caution while driving

Do not adjust the steering wheel while driving. Doing so may cause the driver to mishandle the vehicle and cause an accident, resulting in death or serious injury.

##### ■ After adjusting the steering wheel

Make sure that the steering wheel is securely locked. Otherwise, the steering wheel may move suddenly, possibly causing an accident and resulting in death or serious injury.

# 1-3. Adjustable components (seats, mirrors, steering wheel)

## Anti-glare inside rear view mirror

Glare from the headlights of vehicles behind can be reduced by using the following functions.

### ► Manual anti-glare inside rear view mirror

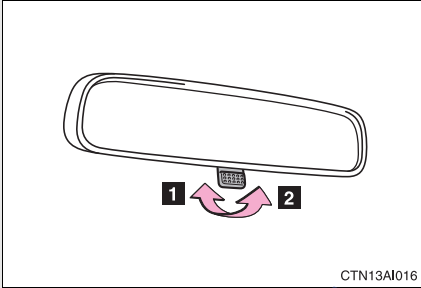

- 1 Normal position
- 2 Anti-glare position

### ► Auto anti-glare inside rear view mirror

In automatic mode, sensors are used to detect the headlights of vehicles behind and the reflected light is automatically reduced.

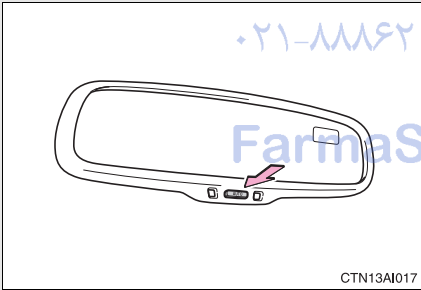

#### Turns automatic mode on/off

The indicator comes on when automatic mode is turned on.

Vehicles with smart key system:

The mirror will revert to the automatic mode each time the "ENGINE START STOP" switch is turned to IGNITION ON mode.

Vehicles without smart key system:

The mirror will revert to the automatic mode each time the engine switch is turned to the "ON" position.



■ **To prevent sensor error (vehicles with auto anti-glare inside rear view mirror)**

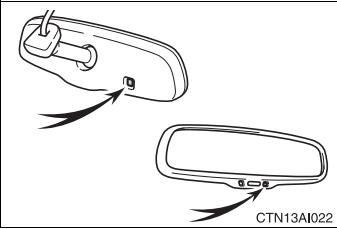

To ensure that the sensors operate properly, do not touch or cover them.

1

Before driving

**! CAUTION**

■ **Caution while driving**

Do not adjust the position of the mirror while driving.

Doing so may lead to mishandling of the vehicle and an accident, resulting in death or serious injury.

تلفن شبانه روزی: ۰۲۱ ۸۸۶۲۰۸۵

FarmaSOS.com

## 1-3. Adjustable components (seats, mirrors, steering wheel)

### Outside rear view mirrors

Mirror angle can be adjusted using the switch.

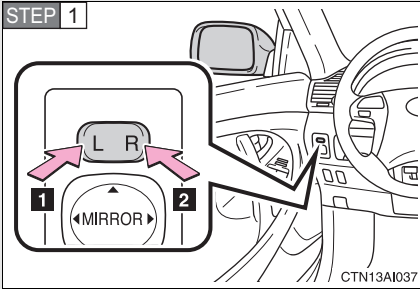

Select a mirror to adjust.

- 1 Left
- 2 Right

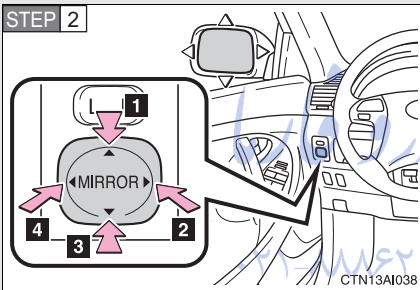

Adjust the mirror.

- 1 Up
- 2 Right
- 3 Down
- 4 Left

FarmaSOS.com

#### ■ Mirror angle can be adjusted when

- ▶ Vehicles with smart key system  
The "ENGINE START STOP" switch is in ACCESSORY or IGNITION ON mode.
- ▶ Vehicles without smart key system  
The engine switch is in the "ACC" or "ON" position.

#### ■ When the mirrors are fogged up (vehicles with mirror defoggers)

Turn on the mirror defoggers to defog the mirrors. (→P. 209)

**! CAUTION**

■ **When driving the vehicle**

Observe the following precautions while driving.

Failing to do so may result in loss of control of the vehicle and cause an accident, resulting in death or serious injury.

- Do not adjust the mirrors while driving.
- Both the driver and passenger side mirrors must be properly adjusted before driving.

■ **When a mirror is moving**

To avoid injury and mirror malfunction, be careful not to get your hand caught by the moving mirror.

■ **When the mirror defoggers are operating (vehicles with mirror defoggers)**

Do not touch the rear view mirror surfaces, as they can become very hot and burn you.

تلفن شبانه روزی: ۰۲۱-۸۸۶۲۰۸۵

FarmaSOS.com

## 1-4. Opening and closing the windows

### Power windows

The power windows can be opened and closed using the following switches.

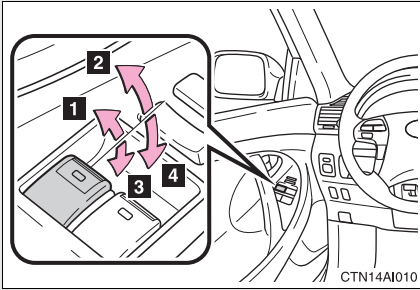

- 1 Closing
- 2 One-touch closing\*
- 3 Opening
- 4 One-touch opening\*

\*: Pressing the switch in the opposite direction will stop window travel partway.

### Lock switch

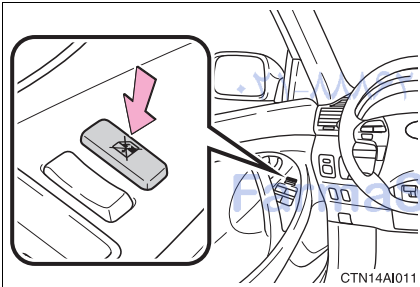

Press the switch down to lock passenger window switches.

Use this switch to prevent children from accidentally opening or closing a passenger window.

### ■ The power windows can be operated when

- ▶ Vehicles with smart key system  
The “ENGINE START STOP” switch is in IGNITION ON mode.
- ▶ Vehicles without smart key system  
The engine switch is in the “ON” position.

### ■ Operating the power windows after turning the engine OFF

- ▶ Vehicles with smart key system  
The power windows can be operated for approximately 45 seconds after the “ENGINE START STOP” switch is turned to ACCESSORY mode or turned OFF. They cannot, however, be operated once either front door is opened.
- ▶ Vehicles without smart key system  
The power windows can be operated for approximately 45 seconds after the engine switch is turned to the “ACC” or “LOCK” position. They cannot, however, be operated once either front door is opened.

### ■ Jam protection function

If an object becomes caught between the window and the window frame, window travel is stopped and the window is opened slightly.

## ⚠ CAUTION

### ■ Closing the windows

Observe the following precautions.  
Failing to do so may result in death or serious injury.

- Check to make sure that all passengers do not have any part of their body in a position where it could be caught when a window is being operated.
- Do not allow children to operate the power windows.  
Closing a power window on someone can cause serious injury, and in some instances, even death.

### ■ Jam protection function

- Never try jamming any part of your body to activate the jam protection function intentionally.
- The jam protection function may not work if something gets caught just before the window fully closes.

## 1-4. Opening and closing the windows

### Moon roof\*

Use the overhead switches to open, close, and tilt the moon roof up and down.

#### ■ Opening and closing

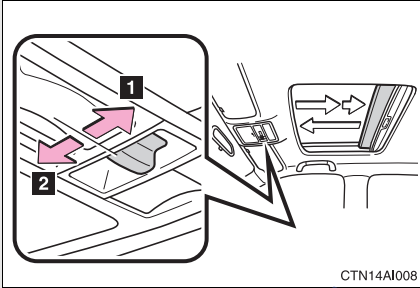

##### 1 Open

The moon roof stops slightly before the fully open position. Push the switch again to fully open.

##### 2 Close

Push the switch in either direction to stop the moon roof partway.

#### ■ Tilt up and down

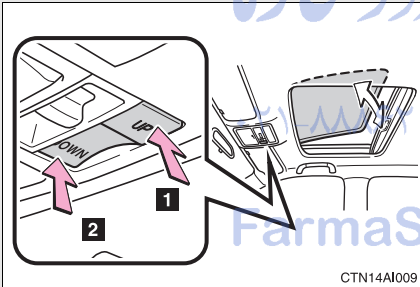

##### 1 Tilt up

##### 2 Tilt down

Push the switch in either direction to stop the moon roof partway.

\*: If equipped

### ■ The moon roof can be operated when

#### ▶ Vehicles with smart key system

The “ENGINE START STOP” switch is in IGNITION ON mode.

#### ▶ Vehicles without smart key system

The engine switch is in the “ON” position.

### ■ Operating the moon roof after turning the engine OFF

#### ▶ Vehicles with smart key system

The moon roof can be operated for approximately 45 seconds after the “ENGINE START STOP” switch is turned to ACCESSORY mode or turned OFF. They cannot, however, be operated once either front door is opened.

#### ▶ Vehicles without smart key system

The moon roof can be operated for approximately 45 seconds after the engine switch is turned to the “ACC” or “LOCK” position. It cannot, however, be operated once either front door is opened.

### ■ Jam protection function

If an object is detected between the moon roof and the frame while closing or tilting down, travel is stopped and the moon roof opens slightly.

### ■ To reduce wind noise

Drive with the moon roof opened to slightly before the fully open position as driving with the moon roof opened fully will cause wind noise.

### ■ Sunshade

The sunshade can be opened and closed manually. However, the sunshade will open automatically when the moon roof is opened.

### ■ Moon roof open reminder function

#### ▶ Vehicles with smart key system

An alarm will sound when the driver’s door is opened with the moon roof not fully closed and the “ENGINE START STOP” switch OFF.

#### ▶ Vehicles without smart key system

An alarm will sound when the driver’s door is opened with the moon roof not fully closed and the engine switch OFF.

### ■ When the moon roof does not close normally

Perform the following procedure:

- If the moon roof closes but then re-opens slightly

**STEP 1** Press and hold the open/close switch in the close position.\*<sup>1</sup>

The moon roof will close, reopen and pause for approximately 10 seconds.\*<sup>2</sup> Then it will close again, tilt up and pause for approximately 1 second. Finally, it will tilt down, open and close.

**STEP 2** Check to make sure that the moon roof is completely closed and then release the switch.

- If the moon roof tilts down but then tilts back up

**STEP 1** Press and hold the “UP” switch\*<sup>1</sup> until the moon roof moves into the tilt up position and stops.

**STEP 2** Release the “UP” switch once and then press and hold the “UP” switch again.\*<sup>1</sup>

The moon roof will pause for approximately 10 seconds in the tilt up position.\*<sup>2</sup> Then it will adjust slightly and pause for approximately 1 second. Finally, it will tilt down, open and close.

**STEP 3** Check to make sure that the moon roof is completely closed and then release the switch.

\*<sup>1</sup>: If the switch is released at the incorrect time, the procedure will have to be performed again from the beginning.

\*<sup>2</sup>: If the switch is released after the above mentioned 10 second pause, automatic operation will be disabled. In that case, press and hold the open/close switch in the close position or press and hold the “UP” switch. The moon roof will tilt up and pause for approximately 1 second. Then it will tilt down, open and close. Check to make sure that the moon roof is completely closed and then release the switch.

If the moon roof does not fully close even after performing the above procedure correctly, have the vehicle inspected by your Toyota dealer.



**⚠ CAUTION****■ Opening the moon roof**

Observe the following precautions.

Failing to do so may cause death or serious injury.

- Do not allow any passengers to put their hands or heads outside the vehicle while it is moving.
- Do not sit on top of the moon roof.

**■ Closing the moon roof**

Observe the following precautions.

Failing to do so may result in death or serious injury.

- Check to make sure that all passengers do not have any part of their bodies in a position where they could be caught when the moon roof is being operated.
- Do not allow children to operate the moon roof.  
Closing the moon roof on someone can cause death or serious injury.

**■ Jam protection function**

- Never try jamming any part of your body to activate the jam protection function intentionally.
- The jam protection function may not work if something gets caught just before the moon roof fully closes.

## 1-5. Refueling

### Opening the fuel tank cap

Perform the following steps to open the fuel tank cap.

#### ■ Before refueling the vehicle

▶ Vehicles with smart key system

Turn the “ENGINE START STOP” switch OFF and ensure that all the doors and windows are closed.

▶ Vehicles without smart key system

Turn the engine switch to the “LOCK” position and ensure that all the doors and windows are closed.

#### ■ Opening the fuel tank cap

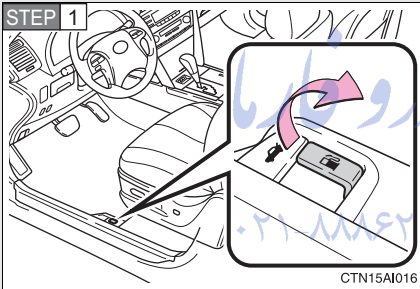

Pull the lever to open the fuel filler door.

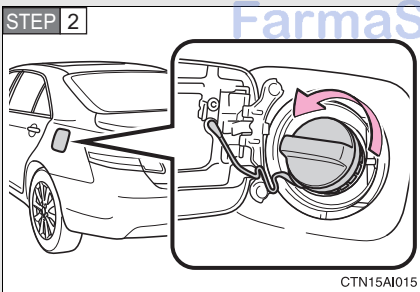

Turn the fuel tank cap slowly to open.

STEP 3

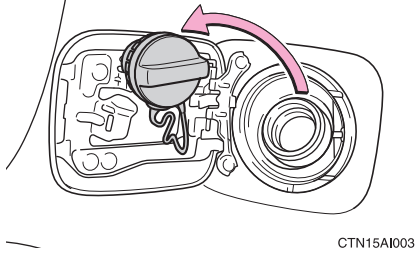

Hang the fuel tank cap on the back of the fuel filler door.

### Closing the fuel tank cap

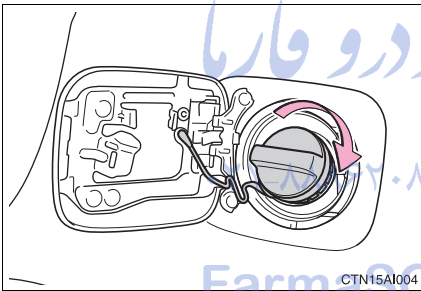

When replacing the fuel tank cap, turn it until a clicking sound is heard.

After releasing your hand, the cap will turn slightly to the opposite direction.

#### ■ Fuel type

Unleaded gasoline (Octane rating 87 [Research Octane Number 91] or higher)

#### ■ Fuel tank capacity

18.5 gal. (70 L, 15.4 Imp. gal.)

 CAUTION

■ **Refueling the vehicle**

Observe the following precautions while refueling the vehicle.  
Failure to do so may result in death or serious injury.

- Touch the vehicle or some other metal surface to discharge any static electricity.  
Sparks resulting from discharging static electricity may cause the fuel vapors to ignite.
- Always hold the grips on the fuel tank cap and turn it slowly to remove it.  
A whooshing sound may be heard when the fuel tank cap is loosened.  
Wait until the sound cannot be heard before fully removing the cap.  
In hot weather, pressurized fuel may spray out of the filler neck and cause injury.
- Do not allow anyone that has not discharged static electricity from their bodies to come close to an open fuel tank.
- Do not inhale vaporized fuel.  
Fuel contains substances that are harmful if inhaled.
- Do not smoke while refueling the vehicle. *تلفن شبانه روزی: ۰۲۱-۸۸۴۲۰۸۸*  
Doing so may cause the fuel to ignite and cause a fire.
- Do not return to the vehicle or touch any person or object that is statically charged.  
This may cause static electricity to build up, resulting in a possible ignition hazard.

■ **When replacing the fuel cap**

Do not use anything but a genuine Toyota fuel tank cap designed for your vehicle. Doing so may cause a fire or other incident which may result in death or serious injury.

 NOTICE**Refueling**

Do not spill fuel during refueling.

Doing so may damage the vehicle, such as causing the exhaust systems to operate abnormally or damaging fuel system components or the vehicle's painted surface.

1

Before driving

# امداد خودرو فارما

تلفن شبانه روزی: ۰۲۱-۸۸۸۶۲۰۸۵

## FarmaSOS.com

## 1-6. Theft deterrent system

### Engine immobilizer system

The vehicle's keys have built-in transponder chips that prevent the engine from starting if the key has not been previously registered in the vehicle's on-board computer.

Never leave the keys inside the vehicle when you leave the vehicle.

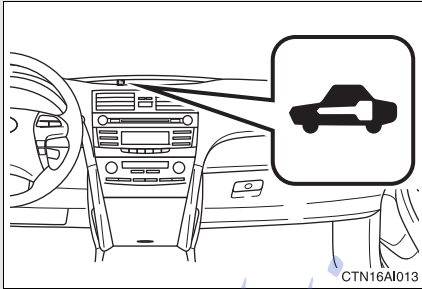

Vehicles with smart key system: The indicator light flashes after the "ENGINE START STOP" switch has been turned OFF to indicate that the system is operating.

Vehicles without smart key system: The indicator light flashes after the key has been removed from the engine switch to indicate that the system is operating.

تلفن شبانه روزی: ۰۲۱-۸۸۶۲۰۸۵

#### ■ System maintenance

[FarmaSOS.com](http://FarmaSOS.com)

The vehicle has a maintenance-free type of engine immobilizer system.

#### ■ Conditions that may cause the system to malfunction

- If the key is in contact with a metallic object
- If the key is in close proximity to or touching a key to the security system (key with a built-in transponder chip) of another vehicle

### ■ Certifications for the engine immobilizer system (for vehicles sold in U.S.A.)

- ▶ Vehicles with smart key system

FCC ID: NI4TMIMB-1

- ▶ Vehicles without smart key system

FCC ID: MOZRI-20BTY (Made in Japan)

FCC ID: MOZRI-21BTY (Made in Canada)

This device complies with Part 15 of the FCC Rules. Operation is subject to the following two conditions: (1) This device may not cause harmful interference, and (2) this device must accept any interference received, including interference that may cause undesired operation.

### ■ Certifications for the engine immobilizer system (for vehicles sold in Canada)

This device complies with RSS-210 of Industry Canada.

Operation is subject to the following two conditions: (1) This device may not cause interference, and (2) this device must accept any interference, including interference that may cause undesired operation of the device.

تلفن شبانه روزی: ۰۲۱-۸۸۶۲۰۸۵

#### CAUTION

Changes or modifications not expressly approved by the party responsible for compliance could void the user's authority to operate the equipment.

#### NOTICE

##### ■ To prevent damage to the key

Do not modify, remove or disable the engine immobilizer system. If any unauthorized changes or modifications are made, the proper operation of the system cannot be guaranteed.

## 1-6. Theft deterrent system

### Alarm\*

The system sounds the alarm and flashes lights when forcible entry is detected.

#### ■ Triggering of the alarm

The alarm is triggered in the following situations:

- A locked door or trunk is unlocked or opened without the key, wireless remote control or entry function of the smart key system.
- The hood is opened while the vehicle is locked.
- The battery is reconnected.

#### ■ Setting the alarm system

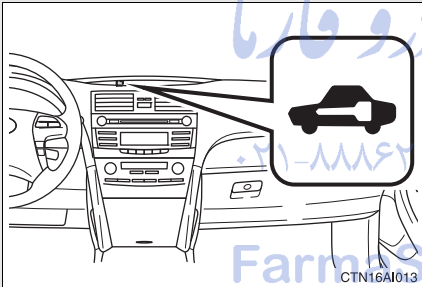

Close the doors, trunk and hood, and lock all doors. The system will be set automatically after 30 seconds.

The indicator light changes from being on to flashing when the system is set.

#### ■ Deactivating or stopping the alarm

Do one of the following to deactivate or stop the alarm.

- Unlock the doors or trunk.
- Start the engine.

\*: If equipped



**■ Items to check before locking the vehicle**

To prevent unexpected triggering of the alarm and vehicle theft, make sure of the following.

- Nobody is in the vehicle.
- The windows and moon roof are closed before the alarm is set.
- No valuables or other personal items are left in the vehicle.

**■ Triggering of the alarm**

The alarm may be triggered in the following situations.  
(Stopping the alarm deactivates the system.)

- A person inside the vehicle opens a door, the trunk or hood.
- The battery is recharged or replaced when the vehicle is locked.

**■ When the battery is disconnected**

Be sure to deactivate the alarm system.

If the battery is discharged before deactivating the alarm system, the alarm may be triggered when the battery is reconnected.

تلفن شبانه روزی: ۰۲۱-۸۸۶۲۰۸۵

FarmaSOS.com

## 1-6. Theft deterrent system

### Theft prevention labels (for U.S.A.)

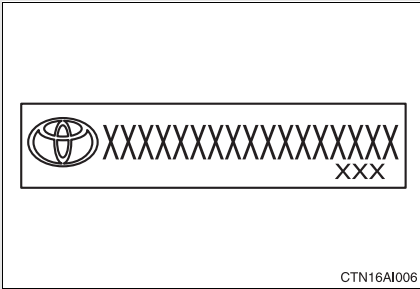

These labels are attached to the vehicle to reduce vehicle theft by facilitating the tracing and recovery of parts from stolen vehicles. Do not remove under penalty of law.

امداد خودرو فارما

تلفن شبانه روزی: ۰۲۱-۸۸۸۶۲۰۸۵

FarmaSOS.com

## 1-7. Safety information

### Correct driving posture

Drive in a good posture as follows:

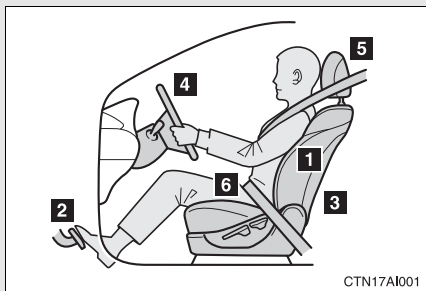

- 1 Sit upright and well back in the seat. (→P. 51)
- 2 Adjust the position of the seat forward or backward to ensure the pedals can be reached and easily depressed to the extent required. (→P. 51)
- 3 Adjust the seatback so that the controls are easily operable.
- 4 Adjust the tilt and telescopic positions of the steering wheel downward so the air-bag is facing your chest. (→P. 65)
- 5 Lock the head restraint in place with the center of the head restraint closest to the top of your ears. (→P. 55)
- 6 Wear the seat belt correctly. (→P. 57)

ایران خودرو فارما

تلفن: ۰۲۱-۸۸۶۲۰۸۵

FarmaSOS.com

 **CAUTION**

■ **While driving**

- Do not adjust the position of the driver's seat while driving.  
Doing so could cause the driver to lose control of the vehicle.
- Do not place a cushion between the driver or passenger and the seatback.  
A cushion may prevent correct posture from being achieved, and reduce the effectiveness of the seat belt and head restraint, increasing the risk of death or serious injury to the driver or passenger.
- Do not place anything under the front seats.  
Objects placed under the front seats may become jammed in the seat tracks and stop the seat from locking in place. This may lead to an accident. The adjustment mechanism may also be damaged.

■ **Adjusting the seat position**

- Take care when adjusting the seat position to ensure that other passengers are not injured by the moving seat.
- Do not put your hands under the seat or near the moving parts to avoid injury.  
Fingers or hands may become jammed in the seat mechanism.

FarmaSOS.com

## 1-7. Safety information

### SRS airbags

The SRS airbags inflate when the vehicle is subjected to certain types of severe impacts that may cause significant injury to the occupants. They work together with the seat belts to help reduce the risk of death or serious injury.

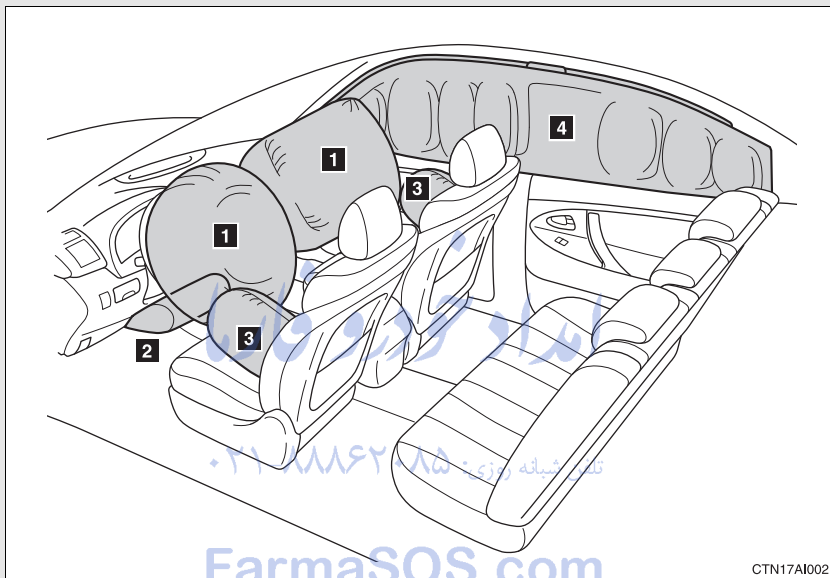

#### ► Front airbags

##### **1** Driver airbag/front passenger airbag

Can help protect the head and chest of the driver and front passenger from impact with interior components.

##### **2** Driver knee airbag

Can help provide driver protection.

#### ► Side and curtain shield airbags

##### **3** Side airbags

Can help protect the torso of the front seat occupants.

##### **4** Curtain shield airbags

Can help protect primarily the head of occupants in the outer seats.

## Airbag system components

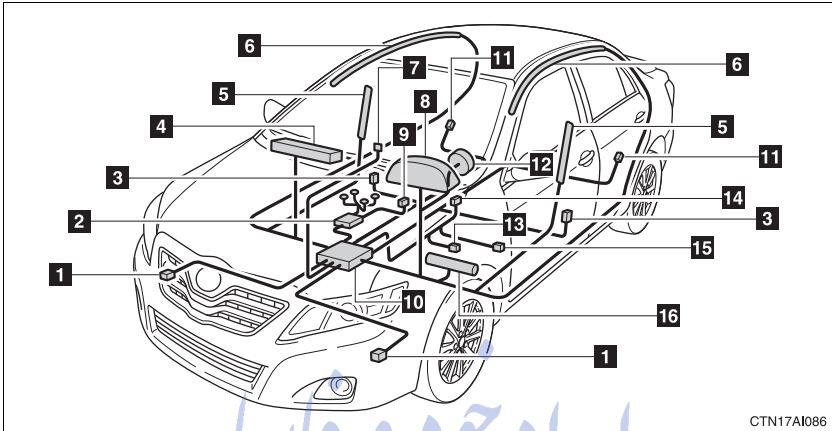

- 1** Front airbag sensors
- 2** Front passenger occupant classification system (ECU and sensors)
- 3** Side and curtain shield airbag sensors
- 4** Front passenger airbag
- 5** Side airbags
- 6** Curtain shield airbags
- 7** "AIR BAG ON" and "AIR BAG OFF" indicator lights
- 8** SRS warning light
- 9** Front passenger's seat belt buckle switch
- 10** Airbag sensor assembly
- 11** Curtain shield airbag sensors
- 12** Driver airbag
- 13** Driver's seat position sensor (with power seat)
- 14** Driver's seat belt buckle switch
- 15** Driver's seat position sensor (with manual seat)
- 16** Driver knee airbag

Your vehicle is equipped with ADVANCED AIRBAGS designed based on US motor vehicle safety standards (FMVSS208). The airbag system controls airbag deployment power for the driver and front passenger. The driver airbag system consists of the driver seat's position sensor etc. The front passenger's airbag system consists of the front passenger occupant classification sensor etc.

The main SRS airbag system components are shown above. The SRS airbag system is controlled by the airbag sensor assembly. The airbag sensor assembly consists of a safing sensor and an airbag sensor.

In certain types of severe frontal or side impacts, the SRS airbag system triggers the airbag inflators. A chemical reaction in the inflators quickly fills the airbags with non-toxic gas to help restrain the motion of the occupants.

1

Before driving

تلفن شبانه روزی: ۰۲۱-۸۸۶۲۰۸۵

FarmaSOS.com

### ■ SRS warning light

This warning light system monitors the airbag sensor assembly, front airbag sensors, side and curtain shield airbag sensors, curtain shield airbag sensors, driver's seat position sensor, driver's seat belt buckle switch, front passenger occupant classification system, "AIR BAG ON" indicator light, "AIR BAG OFF" indicator light, front passenger's seat belt buckle switch, seat belt pretensioner assemblies, inflators, interconnecting wiring and power sources. (→P. 433)

### ■ If the SRS airbags deploy (inflate)

- Bruising and slight abrasions may result from contact with a deploying (inflating) SRS airbag.
- A loud noise and white powder will be emitted.
- Parts of the airbag module (steering wheel hub, airbag cover and inflator) as well as the front seats, and parts of the front and rear pillars and roof side rail, may be hot for several minutes. The airbag itself may also be hot.
- The front windshield may crack.

### ■ SRS airbag deployment conditions (front airbags)

- The front SRS airbags will deploy in the event of an impact that exceeds the set threshold level (the level of force corresponding to a 12 - 18 mph [20 - 30 km/h] frontal collision with a fixed wall that does not move or deform).

However, this threshold velocity will be considerably higher if the vehicle strikes an object, such as a parked vehicle or sign pole, which can move or deform on impact, or if the vehicle is involved in an underride collision (e.g. a collision in which the front of the vehicle "underrides", or goes under, the bed of a truck, etc.).

- It is possible that in some collisions where the forward deceleration of the vehicle is very close to the designed threshold level, the SRS front airbags and the seat belt pretensioners may not activate together.
- The SRS front passenger airbag will not activate if there is no passenger sitting in the front passenger seat. However, the front passenger airbag may deploy if luggage is put in the seat, or the seat belt is fastened, even if the seat is unoccupied. (→P. 99)



### ■ SRS airbag deployment conditions (side airbags and curtain shield airbags)

- The SRS side airbags and SRS curtain shield airbags will deploy in the event of an impact that exceeds the set threshold level (the level of force corresponding to the impact force produced by a 3300 lb. [1500 kg] vehicle colliding with the vehicle cabin from a direction perpendicular to the vehicle orientation at a speed of 12 - 18 mph [20 - 30 km/h]).
- The SRS side airbag on the passenger seat will not activate if there is no passenger sitting in the front passenger seat. However, the side airbag on the passenger seat may deploy if luggage is put in the seat, even if the seat is unoccupied. (→P. 99)

### ■ Conditions under which the SRS airbags may deploy (inflate), other than a collision

The SRS front airbags may also deploy if a serious impact occurs to the underside of your vehicle. Some examples are shown in the illustration.

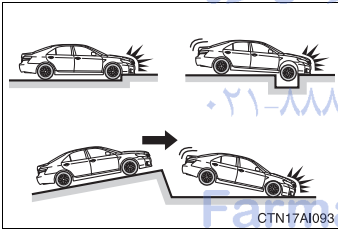

- Hitting a curb, edge of pavement or hard surface
- Falling into or jumping over a deep hole
- Landing hard or vehicle falling

### ■ Types of collisions that may not deploy the SRS airbag (front airbags)

The SRS front airbags are generally not designed to inflate if the vehicle is involved in a side or rear collision, if it rolls over, or if it is involved in a low-speed frontal collision. But, whenever a collision of any type causes sufficient forward deceleration of the vehicle, deployment of the SRS front airbags may occur.

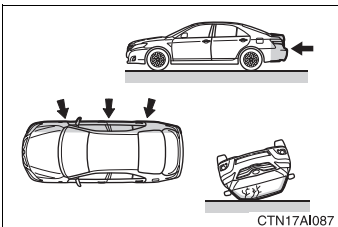

- Collision from the side
- Collision from the rear
- Vehicle rollover

### ■ Types of collisions that may not deploy the SRS airbag (side airbags and curtain shield airbags)

The SRS side airbags and curtain shield airbag system may not activate if the vehicle is subjected to a collision from the side at certain angles, or a collision to the side of the vehicle body other than the passenger compartment.

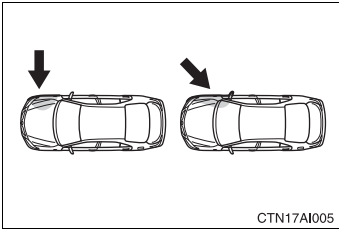

- Collision from the side to the vehicle body other than the passenger compartment
- Collision from the side at an angle

The SRS side airbags and curtain shield airbags are not generally designed to inflate if the vehicle is involved in a frontal or rear collision, if it rolls over, or if it is involved in a low-speed side collision.

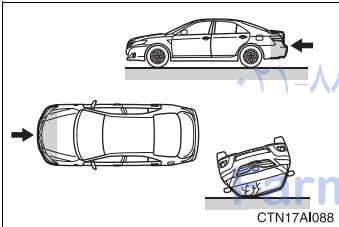

- Collision from the front
- Collision from the rear
- Vehicle rollover

## ■ When to contact your Toyota dealer

In the following cases, contact your Toyota dealer as soon as possible. Do not disconnect the battery cables before contacting your Toyota dealer.

- Any of the SRS airbags have been inflated.

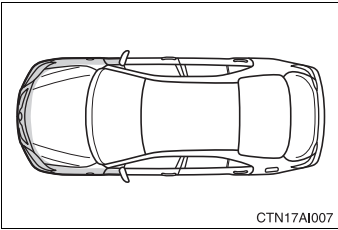

- The front of the vehicle is damaged or deformed, or was involved in an accident that was not severe enough to cause the SRS airbags to inflate.

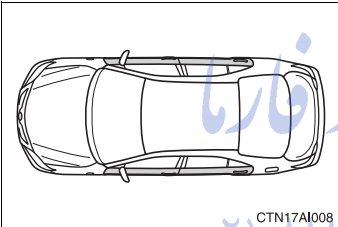

- A portion of a door is damaged or deformed, or the vehicle was involved in an accident that was not severe enough to cause the SRS side airbags and curtain shield airbags to inflate.

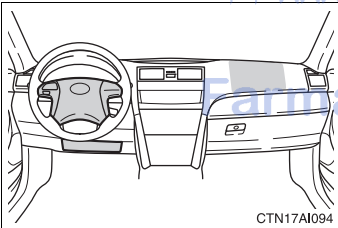

- The pad section of the steering wheel or dashboard or lower portion of the instrument panel is scratched, cracked, or otherwise damaged.

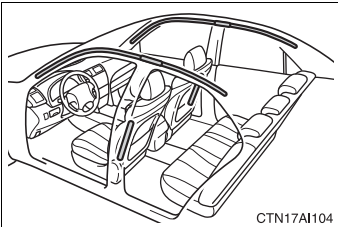

- The surface of the seats with the side airbag is scratched, cracked, or otherwise damaged.
- The portion of the front pillars, rear pillars or roof side rail garnishes (padding) containing the curtain shield airbags inside is scratched, cracked or otherwise damaged.

 CAUTION

■ **SRS airbag precautions**

Observe the following precautions regarding the airbags.  
Failure to do so may cause death or serious injury.

- The driver and all passengers in the vehicle must wear their seat belts properly.

The SRS airbags are supplemental devices to be used with the seat belts.

- The SRS driver airbag deploys with considerable force, and can cause death or serious injury especially if the driver is very close to the airbag. The National Highway Traffic Safety Administration (“NHTSA”) advises:

Since the risk zone for the driver’s airbag is the first 2 - 3 in. (50 - 75 mm) of inflation, placing yourself 10 in. (250 mm) from your driver airbag provides you with a clear margin of safety. This distance is measured from the center of the steering wheel to your breastbone. If you sit less than 10 in. (250 mm) away now, you can change your driving position in several ways:

- Move your seat to the rear as far as you can while still reaching the pedals comfortably.
- Slightly recline the back of the seat.

Although vehicle designs vary, many drivers can achieve the 10 in. (250 mm) distance, even with the driver seat all the way forward, simply by reclining the back of the seat somewhat. If reclining the back of your seat makes it hard to see the road, raise yourself by using a firm, non-slippery cushion, or raise the seat if your vehicle has that feature.

- If your steering wheel is adjustable, tilt it downward. This points the airbag toward your chest instead of your head and neck.

The seat should be adjusted as recommended by NHTSA above, while still maintaining control of the foot pedals, steering wheel, and your view of the instrument panel controls.

## ⚠ CAUTION

### ■ SRS airbag precautions

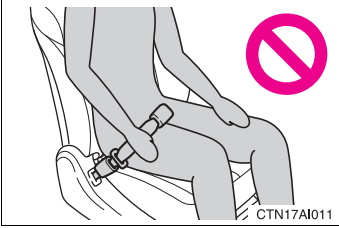

- If the seat belt extender has been connected to the driver's seat belt buckle but the seat belt extender has not also been fastened to the latch plate of the driver's seat belt, the SRS driver's airbag system will judge that the driver is wearing the seat belt even though the seat belt has not been connected. In this case, the driver's airbag may not activate correctly in a collision, resulting in death or serious injury in the event of collision. Be sure to wear the seat belt with the seat belt extender.

- The SRS front passenger airbag also deploys with considerable force, and can cause death or serious injury especially if the front passenger is very close to the airbag. The front passenger seat should be as far from the airbag as possible with the seatback adjusted, so the front passenger sits upright.
- Improperly seated and/or restrained infants and children can be killed or seriously injured by a deploying airbag. An infant or child who is too small to use a seat belt should be properly secured using a child restraint system. Toyota strongly recommends that all infants and children be placed in the rear seats of the vehicle and properly restrained. The rear seats are the safest for infants and children. (→P. 104)

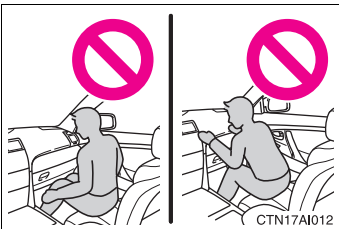

- Do not sit on the edge of the seat or lean against the dashboard.

**! CAUTION**

**■ SRS airbag precautions**

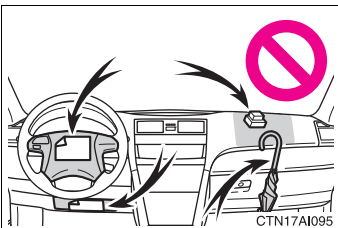
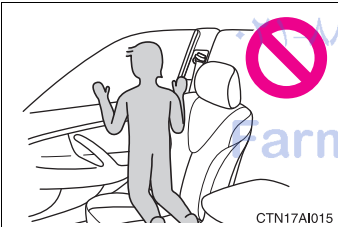
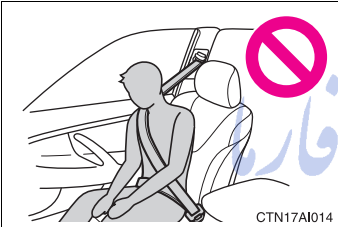
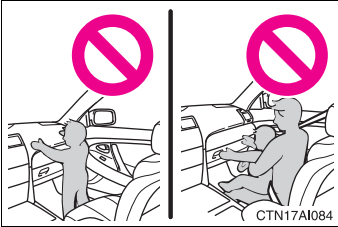

- Do not allow a child to stand in front of the SRS front passenger airbag unit or sit on the knees of a front passenger.
- Do not drive the vehicle while the driver or passenger has items resting on their knees.
- Do not lean against the door, the roof side rail or the front, side and rear pillars.
- Do not allow anyone to kneel on the passenger seat toward the door or put their head or hands outside the vehicle.
- Do not attach anything to or lean anything against areas such as the dashboard, steering wheel pad or lower portion of the instrument panel. These items can become projectiles when SRS driver, front passenger and knee airbags deploy.

## ⚠ CAUTION

### ■ SRS airbag precautions

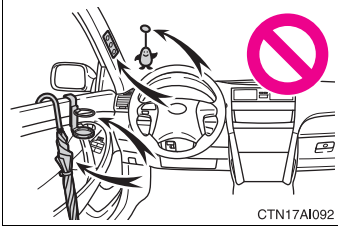

- Do not attach anything to areas such as the door, windshield glass, side door glass, front and rear pillars, roof side rail or assist grip.

- Do not hang coat hangers or other hard objects on the coat hooks. All of these items could become projectiles and seriously injure or kill you, should the SRS curtain shield airbag deploy.

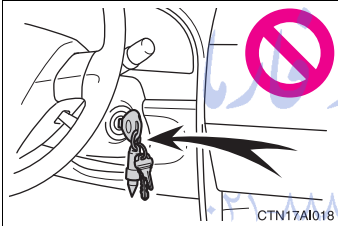

- Vehicles without smart key system: Do not attach any heavy, sharp or hard objects such as keys or accessories to the key. The objects may restrict the SRS knee airbag inflation or be thrust into the driver's seat area by the force of the deploying airbag, thus causing a danger.

- If a vinyl cover is put on the area where the SRS knee airbag will deploy, be sure to remove it.
- Do not use seat accessories which cover the parts where the SRS side airbags inflate as they may interfere with inflation of the airbags.
- Do not strike or apply significant levels of force to the area of the SRS airbag components (→P. 88).  
Doing so can cause the SRS airbags to malfunction.
- Do not touch any of the component parts immediately after the SRS airbags have deployed (inflated) as they may be hot.

 CAUTION

■ **SRS airbag precautions**

- If breathing becomes difficult after the SRS airbag has deployed, open a door or window to allow fresh air in, or leave the vehicle if it is safe to do so. Wash off any residue as soon as possible to prevent skin irritation.
- If the areas where the SRS airbags are stored, such as the steering wheel pad and front and rear pillars garnishes, are damaged or cracked, have them replaced by your Toyota dealer.

■ **Modification and disposal of SRS airbag system components**

Do not dispose of your vehicle or perform any of the following modifications without consulting your Toyota dealer.

The SRS airbags may malfunction or deploy (inflate) accidentally, causing death or serious injury.

- Installation, removal, disassembly and repair of the SRS airbags.
- Repairs, modifications, removal or replacement of the steering wheel, instrument panel, dashboard, seats or seat upholstery, front, side and rear pillars or roof side rail.
- Repairs or modifications of the front fender, front bumper, or side of the occupant compartment.
- Installation of snow plows, winches, etc. to the front grille (bull bars, kangaroo bar etc.).
- Modifications to the vehicle's suspension system.
- Installation of electronic devices such as mobile two-way radios or CD players.
- Modifications to your vehicle for a person with a physical disability.



## 1-7. Safety information

### Front passenger occupant classification system

Your vehicle is equipped with a front passenger occupant classification system. This system detects the conditions of the front passenger seat and activates or deactivates the devices for the front passenger.

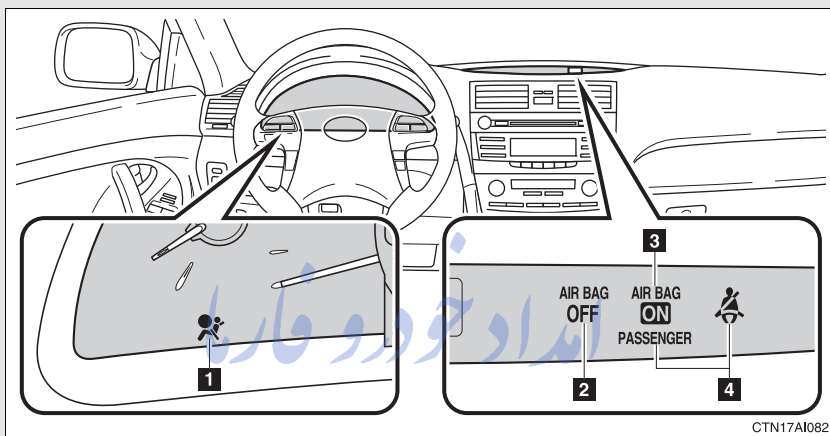

- 1 SRS warning light - تلفن شبانه روزی: ۰۸۵۶۲۰۸۵
- 2 "AIR BAG OFF" indicator light
- 3 "AIR BAG ON" indicator light
- 4 Front passenger's seat belt reminder light

### Conditions and operation of the front passenger occupant classification system

#### ■ Adult\*<sup>1</sup>

Indicator/ warning light	“AIR BAG ON” and “AIR BAG OFF” indicator lights	“AIR BAG ON”
	SRS warning light	Off
	Front passenger’s seat belt reminder light	Flashing* <sup>2</sup>
Devices	Front passenger airbag	Activated
	Side airbag on the front passenger seats	
	Curtain shield airbag in the front passenger side	
	Front passenger’s seat belt pretensioner	

#### ■ Child\*<sup>3</sup> or child restraint system\*<sup>4</sup>

Indicator/ warning light	“AIR BAG ON” and “AIR BAG OFF” indicator lights	“AIR BAG OFF”* <sup>5</sup>
	SRS warning light	Off
	Front passenger’s seat belt reminder light	Flashing* <sup>2</sup>
Devices	Front passenger airbag	Deactivated
	Side airbag on the front passenger seats	
	Curtain shield airbag in the front passenger side	Activated
	Front passenger’s seat belt pretensioner	

### ■ Unoccupied

Indicator/ warning light	“AIR BAG ON” and “AIR BAG OFF” indicator lights	Not illuminated
	SRS warning light	Off
	Front passenger’s seat belt reminder light	
Devices	Front passenger airbag	Deactivated
	Side airbag on the front passenger seats	
	Curtain shield airbag in the front passenger side	Activated
	Front passenger’s seat belt pretensioner	Deactivated

### ■ There is a malfunction in the system

Indicator/ warning light	“AIR BAG ON” and “AIR BAG OFF” indicator lights	“AIR BAG OFF”
	SRS warning light	On
	Front passenger’s seat belt reminder light	Off
Devices	Front passenger airbag	Deactivated
	Side airbag on the front passenger seats	
	Curtain shield airbag in the front passenger side	Activated
	Front passenger’s seat belt pretensioner	

- \*1: The system judges a person of adult size as an adult. When a smaller adult sits in the front passenger seat, the system may recognize him/her as a child depending on his/her physique and posture.
- \*2: In the event the front passenger does not wear a seat belt.
- \*3: When a larger child who has outgrown a child restraint system sits in the front passenger seat, the system may recognize him/her as an adult depending on his/her physique or posture.

- \*4: Never install a rear-facing child restraint system on the front passenger seat. A forward-facing child restraint system should only be installed on the front passenger seat when it is unavoidable. (→P. 104)
- \*5: In case the indicator is not illuminated, consult this manual as for installing the child restraint system properly. (→P. 108)

 CAUTION

**■ Front passenger occupant classification system precautions**

Observe the following precautions regarding the front passenger occupant classification system.

Failure to do so may cause death or serious injury.

- Wear the seat belt properly.
- Make sure the front passenger's seat belt tab has not been left inserted into the buckle before someone sits in the front passenger seat.
- Make sure the "AIR BAG OFF" indicator light is not illuminated when using the seat belt extender for the front passenger seat. If the "AIR BAG OFF" indicator light is illuminated, disconnect the extender tongue from the seat belt buckle, then reconnect the seat belt. Reconnect the seat belt extender after making sure the "AIR BAG ON" indicator light is illuminated. If you use the seat belt extender while the "AIR BAG OFF" indicator light is illuminated, the front passenger airbag, side airbag on the front passenger side airbag may not activate correctly, which could cause death or serious injury in the event of collision.
- Do not apply a heavy load to the front passenger seat or equipment.
- Do not put weight on the front passenger seat by putting your hands or feet on the front passenger seat seatback from the rear passenger seat.
- Do not let a rear passenger lift the front passenger seat with their feet or press on the seatback with their legs.
- Do not put objects under the front passenger seat.

 CAUTION

**Front passenger occupant classification system precautions**

- Do not recline the front passenger seatback so far that it touches a rear seat. This may cause the “AIR BAG OFF” indicator light to be illuminated, which indicates that the passenger’s airbags will not deploy in the event of a severe accident. If the seatback touches the rear seat, return the seatback to a position where it does not touch the rear seat. Keep the front passenger seatback as upright as possible when the vehicle is moving. Reclining the seatback excessively may lessen the effectiveness of the seat belt system.
- If an adult sits in the front passenger seat, the “AIR BAG ON” indicator light is illuminated. If the “AIR BAG OFF” indicator is illuminated, ask the passenger to sit up straight, well back in the seat, feet on the floor, and with the seat belt worn correctly. If the “AIR BAG OFF” indicator still remain illuminated, either ask the passenger to move to the rear seat, or if that is not possible, move the front passenger seat fully rearward.
- When it is unavoidable to install the forward-facing child restraint system on the front passenger seat, install the child restraint system on the front passenger seat in the proper order. (→P. 108)
- Do not modify or remove the front seats.
- Do not kick the front passenger seat or subject it to severe impact. Otherwise, the SRS warning light may come on to indicate a malfunction of the detection system. In this case, contact your Toyota dealer immediately.
- Child restraint systems installed on the rear seat should not contact the front seatbacks.
- Do not use a seat accessory, such as a cushion or seat cover, that covers the seat cushion surface.
- Do not modify or replace the upholstery of the front seat.

## 1-7. Safety information

# Child restraint systems

A child restraint system for a small child or baby must be properly restrained on the seat with the lap portion of the lap/shoulder belt.

The laws of all 50 states of U.S.A. and Canada now require the use of child restraint systems.

### Points to remember

Studies have shown that installing a child restraint system on a rear seat is much safer than installing one to the front passenger seat.

- Choose a child restraint system that suits your vehicle and is appropriate to the age and size of the child.
- For installation details, follow the instructions provided with the child restraint system.

General installation instructions are provided in this manual.

(→P. 108)

تلفن شبانه روزی: ۰۲۱-۸۸۶۲۰۸۵

FarmaSOS.com

## Types of child restraints

Child restraint systems are classified into the following 3 types according to the age and size of the child.

### ► Rear facing — Infant seat/convertible seat

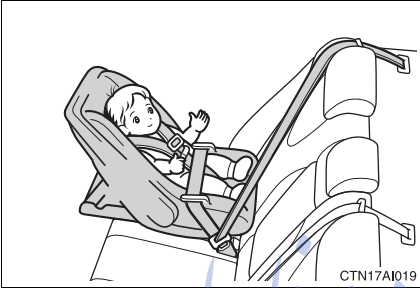

### ► Forward facing — Convertible seat

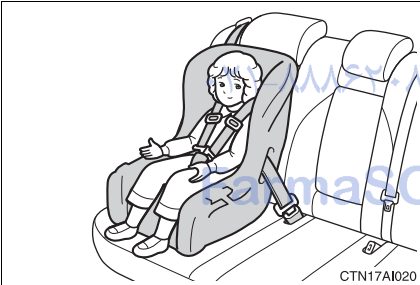

### ► Booster seat



### ■ Selecting an appropriate child restraint system

- Use a child restraint system appropriate for the child until the child becomes large enough to properly wear the vehicle's seat belt.
- If a child is too large for a child restraint system, sit the child on a rear seat and use the vehicle's seat belt. (→P. 57)

### ⚠ CAUTION

#### ■ Child restraint precautions

- For effective protection in automobile accidents and sudden stops, a child must be properly restrained, using a seat belt or child restraint system depending on the age and size of the child. Holding a child in your arms is not a substitute for a child restraint system. In an accident, the child can be crushed against the windshield, or between you and the vehicle's interior.
- Toyota strongly urges the use of a proper child restraint system that conforms to the size of the child, installed on the rear seat. According to accident statistics, the child is safer when properly restrained in the rear seat than in the front seat. تلفن شبانه روزی: ۰۸۵۰۶۶۲۰۸۵
- Never install a rear-facing child restraint system on the front passenger seat even if the "AIR BAG OFF" indicator light is illuminated. In the event of an accident, the force of the rapid inflation of the front passenger airbag can cause death or serious injury to the child if the rear-facing child restraint system is installed on the front passenger seat.
- A forward-facing child restraint system may be installed on the front passenger seat only when it is unavoidable. A child restraint system that requires a top tether strap should not be used in the front passenger seat since there is no top tether strap anchor for the front passenger seat. Adjust the seatback as upright as possible and always move the seat as far back as possible even if the "AIR BAG OFF" indicator light is illuminated, because the front passenger airbag could inflate with considerable speed and force. Otherwise, the child may be killed or seriously injured.



 **CAUTION**
**■ Child restraint precautions**

- Do not use the seat belt extender when installing a child restraint system on the front or rear passenger seat. If installing a child restraint system with the seat belt extender connected to the seat belt, the seat belt will not securely hold the child restraint system, which could cause death or serious injury to the child or other passengers in the event of a sudden stop, sudden swerve or collision.
- Do not allow the child to lean his/her head or any part of his/her body against the door or the area of the seat, front and rear pillars or roof side rail from which the side airbags or curtain shield airbags deploy even if the child is seated in the child restraint system. It is dangerous if the side airbags and curtain shield airbags inflate, and the impact could cause death or serious injury to the child.
- Make sure you have complied with all installation instructions provided by the child restraint manufacturer and that the system is properly secured. If it is not secured properly, it may cause death or serious injury to the child in the event of a sudden stop, sudden swerve or an accident.

**■ Child restraint lock function belt precaution**

Do not allow children to play with the child restraint lock function belt. If the belt becomes twisted around a child's neck, it will not be possible to pull the belt out leading to choking or other serious injuries that could result in death. If this occurs and the buckle cannot be unfastened, scissors should be used to cut the belt.

**■ When the child restraint system is not in use**

- Keep the child restraint system properly secured on the seat even if it is not in use.  
Do not store the restraint unsecured in the passenger compartment.
- If it is necessary to detach the child restraint system, remove it from the vehicle or store it securely in the trunk. This will prevent it from injuring passengers in the event of a sudden stop, sudden swerve or accident.

## 1-7. Safety information

### Installing child restraints

Follow the child restraint system manufacturer's instructions. Firmly secure child restraints to the outside rear seats using the LATCH anchors or a seat belt. Attach the top tether strap when installing a child restraint.

The lap/shoulder belt can be used if your child restraint system is not compatible with the LATCH (Lower Anchors and Tethers for Children) system.

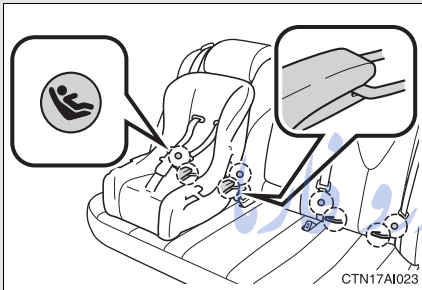

#### Child restraint LATCH anchors

LATCH anchors are provided for the outside rear seats. (Buttons displaying the location of the anchors are attached to the seats.)

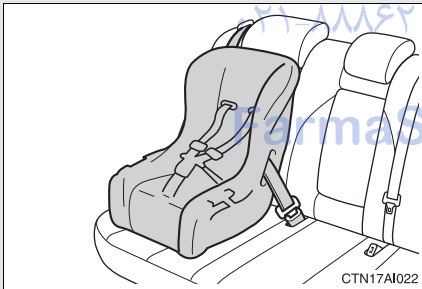

Seat belts equipped with a child restraint locking mechanism (ALR/ELR belts except driver's seat belt) (→P. 57)

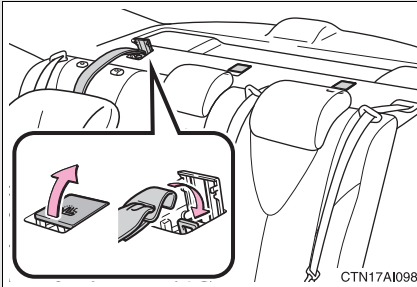

Anchor bracket (for top tether strap)

Anchor brackets are provided for all rear seats.

### Installation with LATCH system

**STEP 1** Vehicles with reclining type rear seat: Adjust the seatback as upright as possible.

► Type A

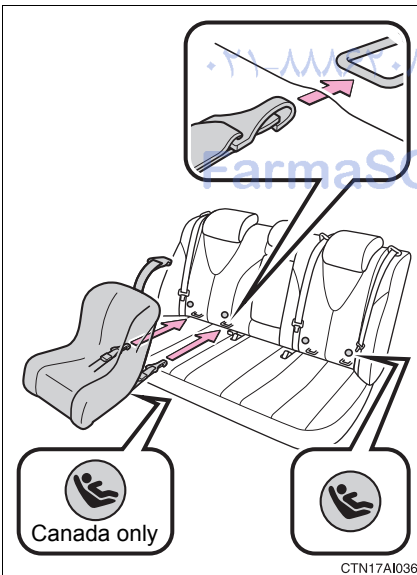

**STEP 2** Widen the gap between the seat cushion and seatback slightly.

**STEP 3** Latch the hooks of the lower straps onto the LATCH anchors.

**STEP 4** If the child restraint has a top tether strap, the top tether strap should be latched onto the top tether strap anchor.

For owners in Canada:

A symbol on a child restraint system indicates the presence of a lower connector system.

► Type B

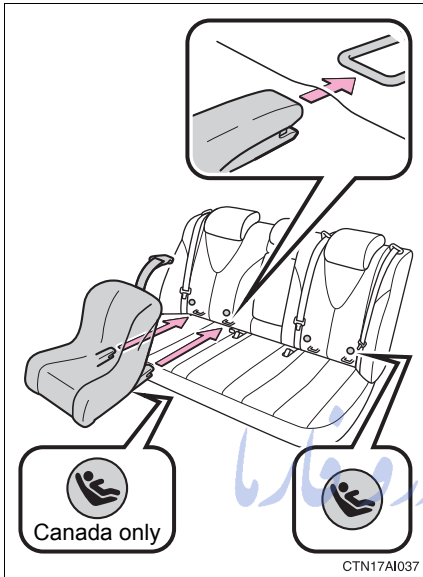

**STEP 2** Widen the gap between the seat cushion and seatback slightly.

**STEP 3** Latch the buckles onto the LATCH anchors.

**STEP 4** If the child restraint has a top tether strap, the top tether strap should be latched onto the top tether strap anchor.

For owners in Canada:

A symbol on a child restraint system indicates the presence of a lower connector system.

تلفن شبانه روزی: ۰۲۱-۸۸۶۲۰۸۵

FarmaSOS.com

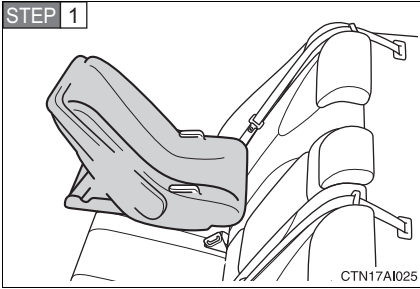
**Installing child restraints using a seat belt (child restraint lock function belt)****■ Rear facing — Infant seat/convertible seat**

Place the child seat on the rear seat facing the rear of the vehicle.

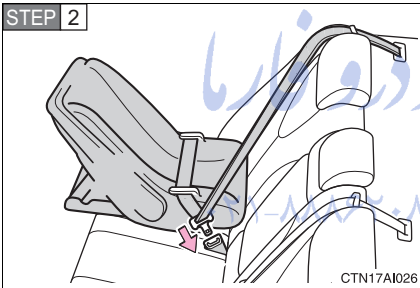

Run the seat belt through the child seat and insert the plate into the buckle. Make sure that the belt is not twisted.

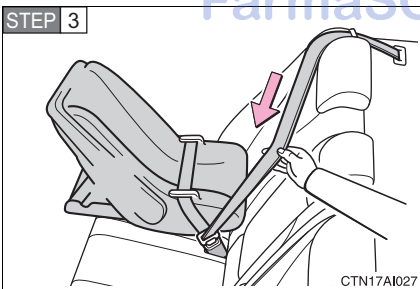

Fully extend the shoulder belt and then allow it to retract slightly in order to activate the ALR lock mode.

Lock mode allows the seat belt to retract only.

1

Before driving

FarmaSOS.com

تلفن شبانه روزی: ۰۲۱-۸۸۸۸۸۸۸۸

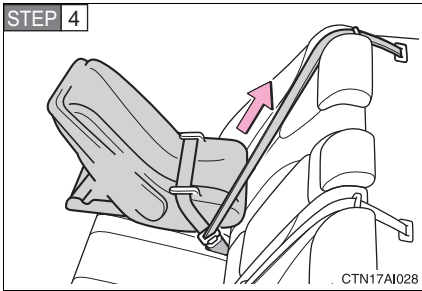

While pushing the child seat down into the rear seat, allow the shoulder belt to retract until the child seat is securely in place.

After the shoulder belt has retracted to a point where there is no slack in the belt, pull the belt to check that it cannot be extended.

### ■ Forward facing — Convertible seat

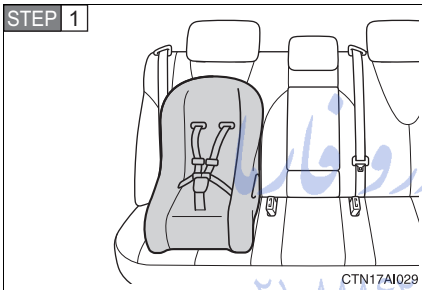

Place the child seat on the seat facing the front of the vehicle.

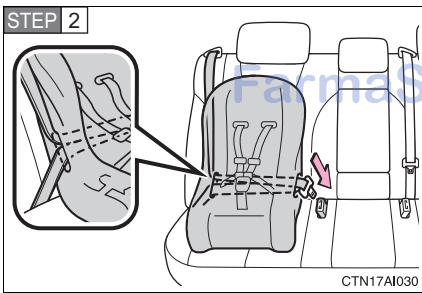

Run the seat belt through the child seat and insert the plate into the buckle. Make sure that the belt is not twisted.

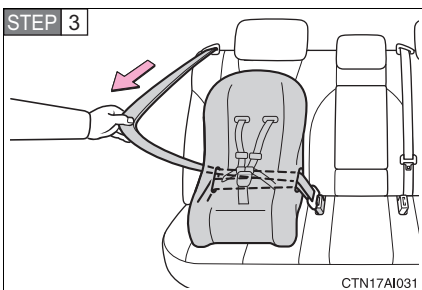

Fully extend the shoulder strap and then allow it to retract slightly into the ALR lock mode.

Lock mode allows the seat belt to retract only.

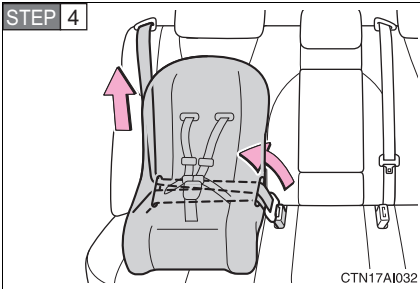

While pushing the child seat into the rear seat, allow the shoulder belt to retract until the child seat is securely in place.

After the shoulder belt has retracted to a point where there is no slack in the belt, pull the belt to check that it cannot be extended.

**STEP 5** If the child restraint has a top tether strap, the top tether strap should be latched onto the top tether strap anchor. (→P. 114)

### ■ Booster seat

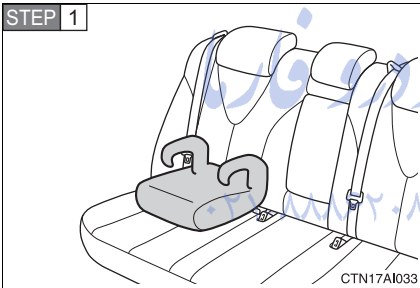

Place the booster seat on the seat facing the front of the vehicle.

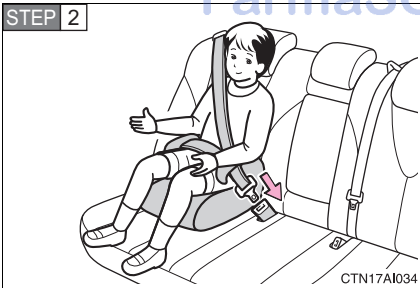

Sit the child in the booster seat. Fit the seat belt to the booster seat according to the manufacturer's instructions and insert the plate into the buckle. Make sure that the belt is not twisted.

Check that the shoulder belt is correctly positioned over the child's shoulder, and that the lap belt is as low as possible.

(→P. 57)

### Removing a child restraint installed with a seat belt

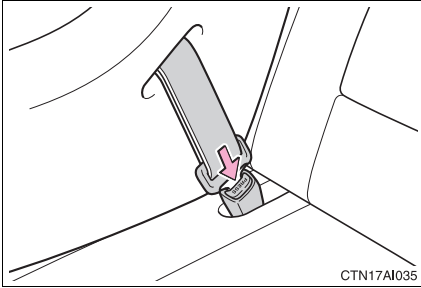

Push the release button and fully retract the seat belt.

### Child restraint systems with a top tether strap

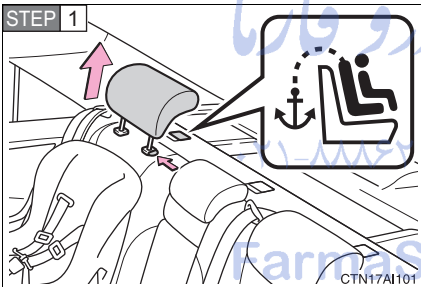

Secure the child restraint using the seat belt or LATCH anchors. Remove the head restraint.

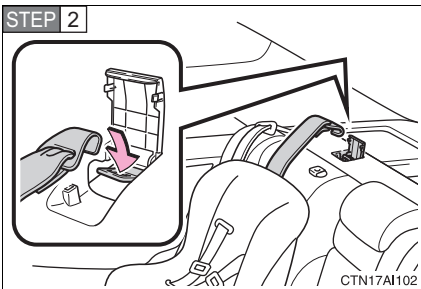

Open the anchor bracket cover, latch the hook onto the anchor bracket and tighten the top tether strap.

Make sure the top tether strap is securely latched.



### ■ Laws and regulations pertaining to anchorages

The LATCH system conforms to FMVSS225 or CMVSS210.2.

Child restraint systems conforming to FMVSS213 or CMVSS213 specifications can be used.

This vehicle is designed to conform to the SAE J1819.

### CAUTION

#### ■ When installing a booster seat

Do not fully extend the shoulder belt to prevent the belt from going to ALR lock mode: (→P. 60)

ALR mode causes the belt to tighten only which could cause injury or discomfort to the child.

تلفن شبانه روزی: ۰۲۱-۸۸۶۲۰۸۵

FarmaSOS.com

**! CAUTION**

**■ When installing a child restraint system**

Follow the directions given in the child restraint system installation manual and fix the child restraint system securely in place.

If the child restraint system is not correctly fixed in place, the child or other passengers may be seriously injured or even killed in the event of sudden braking, sudden swerving or an accident.

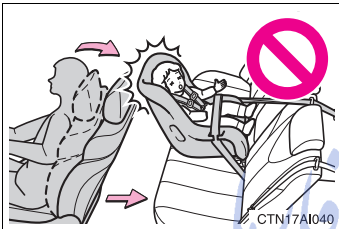

- If the driver's seat interferes with the child restraint system and prevents it from being attached correctly, attach the child restraint system to the right-hand rear seat.

- Adjust the front passenger seat so that it does not interfere with the child restraint system.

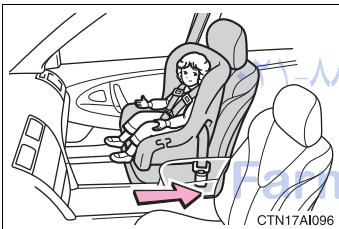

- Only put a forward-facing or booster child seat on the front seat when unavoidable. When installing a forward-facing or booster child seat on the front passenger seat, move the seat as far back as possible even if the "AIR BAG OFF" indicator light is illuminated. Failing to do so may result in death or serious injury if the airbags deploy (inflate).

- Vehicles with reclining type rear seat: When installing a child restraint system in the rear center position, adjust both seatbacks as upright as possible. The seatbacks must be adjusted to the same angle. Otherwise, the child restraint system cannot be securely restrained and this may cause death or serious injuries in the event of sudden braking, sudden swerving or an accident.

 **CAUTION**
**■ When installing a child restraint system**

- When a booster seat is installed, always ensure that the shoulder belt is positioned across the center of the child's shoulder. The belt should be kept away from the child's neck, but not so that it could fall off the child's shoulder. Failing to do so may result in death or serious injury in the event of sudden braking, sudden swerving or an accident.
- Ensure that the belt and tab are securely locked and the seat belt is not twisted.
- Push and pull the child seat from side to side and forward to be sure it is secure.
- After securing a child restraint system, never adjust the seat.
- Follow all installation instructions provided by the child restraint system manufacturer.
- When a child restraint system with a top tether strap is installed, do not install the head restraint. The head restraint may interfere with the top tether strap preventing secure installation of the child restraint system.
- Make sure to properly store the removed head restraint in a secure place when you use the child restraint system on the rear seat.

**■ Do not use a seat belt extender**

If a seat belt extender is used when installing a child restraint system, the seat belt will not securely hold the child restraint system, which could cause death or serious injury to the child or other passengers in the event of sudden braking, sudden swerving or a collision.

**■ To correctly attach a child restraint system to the anchors**

When using the LATCH anchors, be sure that there are no foreign objects around the anchors and that the seat belt is not caught behind the child restraint system. Make sure the child restraint system is securely attached, or it may cause death or serious injury to the child or other passengers in the event of a sudden stop, sudden swerve or accident.

امداد خودرو فارما

تلفن شبانه روزی: ۰۲۱-۸۸۸۶۲۰۸۵

**FarmaSOS.com**

## 2-1. Driving procedures

### Driving the vehicle

The following procedures should be observed to ensure safe driving:

#### ■ Starting the engine

→P. 131, 135

#### ■ Driving

##### ▶ Automatic transmission

**STEP 1** With the brake pedal depressed, shift the shift lever to D. (→P. 138)

**STEP 2** Release the parking brake. (→P. 145)

**STEP 3** Gradually release the brake pedal and gently depress the accelerator pedal to accelerate the vehicle.

##### ▶ Manual transmission

**STEP 1** With the clutch pedal fully depressed, shift the shift lever to 1. (→P. 142)

**STEP 2** Release the parking brake. (→P. 145)

**STEP 3** Gradually release the clutch pedal. At the same time, gently depress the accelerator pedal to accelerate the vehicle.

#### ■ Stopping

##### ▶ Automatic transmission

**STEP 1** With the shift lever in D, depress the brake pedal.

**STEP 2** If necessary, set the parking brake.

When the vehicle is stopped for an extended period of time, shift the shift lever to P or N. (→P. 138)

##### ▶ Manual transmission

**STEP 1** With the clutch pedal fully depressed, depress the brake pedal.

**STEP 2** If necessary, set the parking brake.

When the vehicle is stopped for an extended period of time, shift the shift lever to N. (→P. 142)

## ■ Parking the vehicle

### ▶ Automatic transmission

**STEP 1** With the shift lever in D, depress the brake pedal.

**STEP 2** Set the parking brake. (→P. 145)

**STEP 3** Shift the shift lever to P. (→P. 138)

When parking on a hill, if necessary, block the wheels.

**STEP 4** Vehicles with smart key system:

Turn the “ENGINE START STOP” switch OFF and stop the engine.

Vehicles without smart key system:

Turn the engine switch to the “LOCK” position and stop the engine.

**STEP 5** Lock the door, making sure that you have the key on your person.

### ▶ Manual transmission

**STEP 1** With the clutch pedal fully depressed, depress the brake pedal.

**STEP 2** Set the parking brake. (→P. 145)

**STEP 3** Shift the shift lever to N. (→P. 142)

When parking on a hill, shift the shift lever to 1 or R. If necessary, block the wheels.

**STEP 4** Turn the engine switch to the “LOCK” position and stop the engine.

**STEP 5** Lock the door, making sure that you have the key on your person.

## Starting on a steep uphill

### ► Automatic transmission

**STEP 1** Firmly set the parking brake and shift the shift lever to D.

**STEP 2** Gently depress the accelerator pedal.

**STEP 3** Release the parking brake.

### ► Manual transmission

**STEP 1** With the parking brake firmly set and the clutch pedal fully depressed, shift the shift lever to 1.

**STEP 2** Lightly depress the accelerator pedal at the same time as gradually releasing the clutch pedal.

**STEP 3** Release the parking brake.

## ■ Driving in the rain

- Drive carefully when it is raining, because visibility will be reduced, the windows may become fogged-up, and the road will be slippery.
- Drive carefully when it starts to rain, because the road surface will be especially slippery.
- Refrain from high speeds when driving on an expressway in the rain, because there may be a layer of water between the tires and the road surface, preventing the steering and brakes from operating properly.

## ■ Breaking in your new Toyota

To extend the life of the vehicle, the following precautions are recommended to observe:

- For the first 186 miles (300 km):  
Avoid sudden stops.
- For the first 994 miles (1600 km):
  - Do not drive at extremely high speeds.
  - Avoid sudden acceleration.
  - Do not drive continuously in the low gears.
  - Do not drive at a constant speed for extended periods.

### ■ Drum-in-disc type parking brake system

Your vehicle has a drum-in-disc type parking brake system. This type of brake system needs bedding-down of the brake shoes periodically or whenever the parking brake shoes and/or drum are replaced. Have your Toyota dealer perform the bedding down.

### ■ Operating your vehicle in a foreign country

Comply with the relevant vehicle registration laws and confirm the availability of the correct fuel. (→P. 484)

#### CAUTION

#### ■ When starting the vehicle (vehicles with an automatic transmission)

Always keep your foot on the brake pedal while stopped with the engine running. This prevents the vehicle from creeping.

#### ■ When driving the vehicle

- Do not drive if you are unfamiliar with the location of the brake and accelerator pedals to avoid depressing the wrong pedal.
  - Accidentally depressing the accelerator pedal instead of the brake pedal will result in sudden acceleration that may lead to an accident that could result in death or serious injury.
  - When backing up, you may twist your body around, leading to a difficulty in operating the pedals. Make sure to operate the pedals properly.
  - Make sure to keep a correct driving posture even when moving the vehicle only slightly, allowing you to depress the brake and accelerator pedals properly.
  - Depress the brake pedal using your right foot. Depressing the brake pedal using your left foot may delay response in an emergency, resulting in an accident.
- Do not drive the vehicle over or stop the vehicle near flammable materials. The exhaust system and exhaust gases can be extremely hot. This may cause a fire if there is any flammable material nearby.
- Vehicles with an automatic transmission: Do not let the vehicle roll backwards while the shift lever is in a driving position, or roll forward while the shift lever is in R.
 

Doing so may cause the engine to stall or lead to poor brake and steering performance, resulting in an accident or damage to the vehicle.



 CAUTION

- If the smell of exhaust is noticed inside the vehicle, open the windows and check that the trunk is closed. Large amounts of exhaust in the vehicle can cause driver drowsiness and an accident, resulting in death or a serious health hazard. Have the vehicle inspected by your Toyota dealer immediately.
- On vehicles with an automatic transmission, do not shift the shift lever to P while the vehicle is moving.  
Doing so can damage the transmission and may result in a loss of vehicle control.
- Do not shift the shift lever to R while the vehicle is moving forward.  
Doing so can damage the transmission and may result in a loss of vehicle control.
- Do not shift the shift lever to D (vehicles with an automatic transmission) or 1 (vehicles with a manual transmission) while the vehicle is moving backward.  
Doing so can damage the transmission and may result in a loss of vehicle control.
- Moving the shift lever to N while the vehicle is moving will disengage the engine from the transmission. Engine braking is not available when N is selected.
- During normal driving, do not turn off the engine. Turning the engine off while driving will not cause loss of steering or braking control, but the power assist to these systems will be lost. This will make it more difficult to steer and brake, so you should pull over and stop the vehicle as soon as it is safe to do so.  
However, in the event of an emergency, such as if it becomes impossible to stop the vehicle in the normal way: →P. 432
- Use engine braking (downshift) to maintain a safe speed when driving down a steep hill.  
Using the brakes continuously may cause the brakes to overheat and lose effectiveness. (→P. 139)

 **CAUTION**

- When stopped on an inclined surface, use the brake pedal and parking brake to prevent the vehicle from rolling backward or forward and causing an accident.
- Do not adjust the position of the steering wheel, the seat, or the inside or outside rear view mirrors while driving.  
Doing so may result in a loss of vehicle control that can cause accidents that may result in death or serious injury.
- Always check that all passengers' arms, heads or other parts of their bodies are not outside the vehicle, as this may result in death or serious injury.
- Do not drive in excess of the speed limit. Even if the legal speed limit permits it, do not drive over 85 mph (140 km/h) unless your vehicle has high-speed capability tires. Driving over 85 mph (140 km/h) may result in tire failure, loss of control and possible injury. Be sure to consult a tire dealer to determine whether the tires on your vehicle are high-speed capability tires or not before driving at such speeds.

■ **When driving on slippery road surfaces**

- Sudden braking, acceleration and steering may cause tire slippage and reduce your ability to control the vehicle, resulting in an accident.
- Sudden changes in engine speed, such as engine braking caused by up-shifting or down-shifting, may cause the vehicle to skid, resulting in an accident.
- After driving through a puddle, lightly depress the brake pedal to make sure that the brakes are functioning properly. Wet brake pads may prevent the brakes from functioning properly. If the brakes on only one side are wet and not functioning properly, steering control may be affected, resulting in an accident.

■ **When shifting the shift lever**

Vehicles with an automatic transmission: Be careful not to shift the shift lever with the accelerator pedal depressed.

This may lead to unexpected rapid acceleration of the vehicle that may cause an accident and result in death or serious injury.

 CAUTION

■ **When the vehicle is stopped**

- Do not race the engine.

If the vehicle is in any gear other than P (automatic transmission only) or N the vehicle may accelerate suddenly and unexpectedly, and may cause an accident.

- Do not leave the vehicle with the engine running for a long time.  
If such a situation cannot be avoided, park the vehicle in an open space and check that exhaust fumes do not enter the vehicle interior.
- Vehicles with an automatic transmission: Always keep a foot on the brake pedal while the engine is running to prevent an accident caused by the vehicle moving.

■ **When the vehicle is parked**

- Do not leave glasses, cigarette lighters, spray cans, or soft drink cans in the vehicle when it is in the sun.

Doing so may result in the following.

- Gas may leak from a cigarette lighter or spray can, and may lead to a fire.
- The temperature inside the vehicle may cause the plastic lenses and plastic material of eye glasses to deform or crack.
- Soft drink cans may fracture, causing the contents to spray over the interior of the vehicle, and may also cause a short circuit in the vehicle's electrical components.

- Always apply the parking brake, shift the shift lever to P (automatic transmission only), stop the engine and lock the vehicle.

Do not leave the vehicle unattended while the engine is running.

- Do not touch the exhaust pipe while the engine is running or immediately after turning the engine off.

Doing so may cause burns.

- Do not leave the engine running in an area with snow build-up, or where it is snowing. If snowbanks build up around the vehicle while the engine is running, exhaust gases may collect and enter the vehicle. This may lead to death or a serious health hazard.

 **CAUTION****■ Exhaust gases**

Exhaust gases include harmful carbon monoxide (CO) that is colorless and odorless. Inhaling exhaust gases may lead to death or a serious health hazard.

- If the vehicle is in a poorly ventilated area, stop the engine. In a closed area, such as a garage, exhaust gases may collect and enter the vehicle. This may lead to death or a serious health hazard.
- The exhaust should be checked occasionally. If there is a hole or crack caused by corrosion, damage to a joint or abnormal exhaust noise, be sure to have the vehicle inspected and repaired by your Toyota dealer. Failure to do so may allow exhaust gases to enter the vehicle, resulting in death or a serious health hazard.

**■ When taking a nap in the vehicle**

Always turn the engine off. Otherwise, you may accidentally move the shift lever or depress the accelerator pedal, which could cause an accident or fire due to engine overheating. Additionally, if the vehicle is parked in a poorly ventilated area, exhaust gases may collect and enter the vehicle, leading to death or a serious health hazard.

 CAUTION

■ **When braking the vehicle**

- When the brakes are wet, drive more cautiously.  
Braking distance increases when the brakes are wet, and may cause one side of the vehicle to brake differently than the other side. Also the parking brake may not securely hold the vehicle.
- If the power brake assist function does not operate, do not follow other vehicles closely and avoid downhills or sharp turns that require braking.  
In this case, braking is still possible, but it will require more force on the pedal than usual. Braking distance may also increase.
- Do not pump the brake pedal if the engine stalls.  
Each push on the brake pedal uses up the reserve for the power-assisted brakes.
- The brake system consists of 2 individual hydraulic systems: If one of the systems fails, the other will still operate. In this case, the brake pedal should be depressed more firmly than usual and braking distance becomes longer.  
Do not drive your vehicle with only a single brake system. Have your brakes fixed immediately.

FarmaSOS.com

 NOTICE

**■ When driving the vehicle**
**▶ Manual transmission**

- Do not shift gears unless the clutch pedal is fully depressed. After shifting, do not release the clutch abruptly. Doing so may damage the clutch, transmission and gears.
- Do not rest your foot on the clutch pedal while driving. Doing so may cause clutch trouble.
- Do not use any gears other than the first gear when starting off and moving forward. Doing so may damage the clutch.
- Do not use the clutch to hold the vehicle when stopping on an uphill grade. Doing so may damage the clutch.
- Do not shift into reverse when the vehicle is still moving. Doing so may damage the clutch, transmission and gears.

**▶ Automatic transmission**

Do not use the accelerator pedal or depress the accelerator and brake pedals together to hold the vehicle on a hill.

**■ When parking the vehicle**

Vehicles with an automatic transmission: Always put the shift lever in P. Failure to do so may cause the vehicle to move or the vehicle may accelerate suddenly if the accelerator pedal is accidentally depressed.

**■ Avoiding damage to vehicle parts**

- Do not turn the steering wheel fully in either direction and hold it there for a long time. Doing so may damage the power steering motor.
- When driving over bumps in the road, drive as slowly as possible to avoid damaging the wheels, underside of the vehicle, etc.

 NOTICE

■ **If you hear a squealing or scraping noise (brake pad wear limit indicators)**

Have the brake pads checked and replaced by your Toyota dealer as soon as possible.

Rotor damage can result if the pads are not replaced when needed.

It is dangerous to drive the vehicle when the wear limits of the brake pads and/or that of the brake discs are exceeded.

■ **If you get a flat tire while driving**

A flat or damaged tire may cause the following situations. Hold the steering wheel firmly and gradually press the brake pedal to slow down the vehicle.

- It may be difficult to control your vehicle.
- The vehicle will make abnormal sounds.
- The vehicle will behave abnormally.

Replace a flat tire with a new one. (→P. 457)

■ **When encountering flooded roads**

Do not drive on a road that has flooded after heavy rain etc. Doing so may cause the following serious damage to the vehicle.

- Engine stalling
- Short in electrical components
- Engine damage caused by water immersion

In the event that you drive on a flooded road and the vehicle is flooded, be sure to have your Toyota dealer check the following.

- Brake function
- Changes in quantity and quality of engine oil, and transaxle fluid etc.
- Lubricant condition for the bearings and suspension joints (where possible) and the function of all joints, bearings, etc.

## 2-1. Driving procedures

### Engine (ignition) switch (vehicles with smart key system)

Performing the following operations when carrying the electronic key on your person starts the engine or changes “ENGINE START STOP” switch modes.

#### ■ Starting the engine

**STEP 1** Check that the parking brake is set.

**STEP 2** Check that the shift lever is set in P.

**STEP 3** Sit in the driver’s seat and firmly depress the brake pedal.

The “ENGINE START STOP” switch indicator turns green. If the indicator does not turn green, the engine cannot be started.

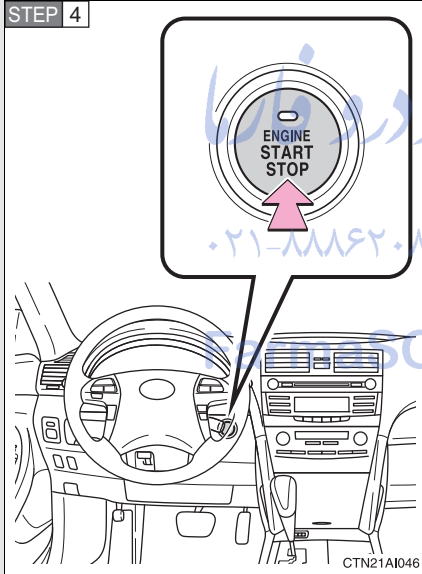

Press the “ENGINE START STOP” switch.

The engine will crank until it starts or for up to 25 seconds, whichever is less. If you press and hold the “ENGINE START STOP” switch, the engine will keep cranking for about 30 seconds maximum.

Continue depressing the brake pedal until the engine is completely started.

The engine can be started from any mode.



### ■ Changing “ENGINE START STOP” switch mode

Modes can be changed by pressing the “ENGINE START STOP” switch with the brake pedal released. (The mode changes each time the switch is pressed.)

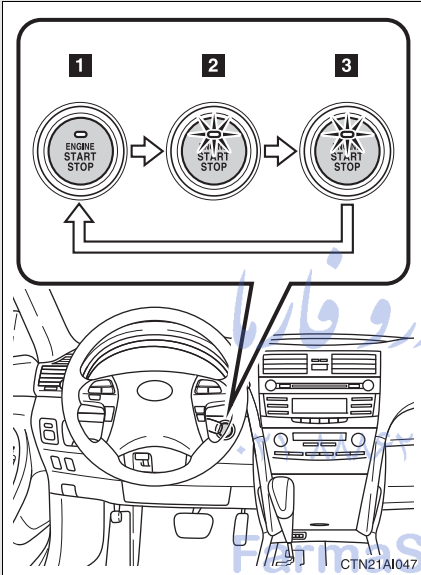

#### 1 OFF\*

Emergency flashers can be used.

#### 2 ACCESSORY mode

Some electrical components such as the audio system can be used.

The “ENGINE START STOP” switch indicator turns amber.

#### 3 IGNITION ON mode

All electrical components can be used.

The “ENGINE START STOP” switch indicator turns amber.

\*: If the shift lever is in a position other than “P” when turning off the engine, the “ENGINE START STOP” switch will be turned to ACCESSORY mode, not to OFF.

### ■ Steering lock release

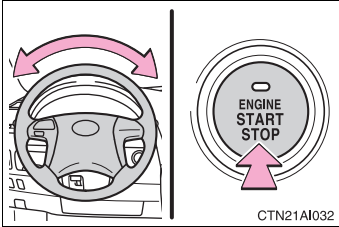

Make sure that the steering wheel lock is released.

To release the steering wheel lock, gently turn the wheel left or right while pressing the “ENGINE START STOP” switch.

If the steering wheel lock does not release, the “ENGINE START STOP” switch indicator will flash green.

### ■ If the engine does not start

The engine immobilizer system may not have been deactivated. (→P. 80)

### ■ When the “ENGINE START STOP” switch indicator flashes in amber

The system may be malfunctioning. Have the vehicle inspected by your Toyota dealer immediately.

### ■ Auto power OFF function

If the vehicle is left in ACCESSORY mode for more than an hour with the shift lever in P, the “ENGINE START STOP” switch will automatically turn OFF.

### ■ Key battery depletion

→P. 32

### ■ When the electronic key battery is discharged

→P. 401

### ■ Conditions affecting operation

→P. 30

### ■ Note for the entry function

→P. 33

 CAUTION

■ **When starting the engine**

Always start the engine while sitting in the driver's seat. Do not depress the accelerator pedal while starting the engine under any circumstances. Doing so may cause an accident resulting in death or serious injury.

■ **Stopping the engine in an emergency**

If you want to stop the engine in an emergency while driving the vehicle, push and hold the "ENGINE START STOP" switch for more than 3 seconds. However, do not touch the "ENGINE START STOP" switch while driving except in an emergency. Turning the engine off while driving will not cause loss of steering or braking control, but the power assist to these systems will be lost. This will make it more difficult to steer and brake, so you should pull over and stop the vehicle as soon as it is safe to do so.

 NOTICE

■ **To prevent battery discharge**

Do not leave the "ENGINE START STOP" switch in ACCESSORY or IGNITION ON mode for long periods without the engine running.

■ **When starting the engine**

- Do not race a cold engine.
- If the engine becomes difficult to start or stalls frequently, have the engine checked immediately.

## 2-1. Driving procedures

### Engine (ignition) switch (vehicles without smart key system)

#### ■ Starting the engine

##### ► Automatic transmission

- STEP 1** Check that the parking brake is set.
- STEP 2** Check that the shift lever is set in P.
- STEP 3** Sit in the driver's seat and firmly depress the brake pedal.
- STEP 4** Turn the engine switch to the "START" position and start the engine.

##### ► Manual transmission

- STEP 1** Check that the parking brake is set.
- STEP 2** Check that the shift lever is set in N.
- STEP 3** Firmly depress the clutch pedal.
- STEP 4** Turn the engine switch to the "START" position and start the engine.

#### ■ Changing engine switch mode

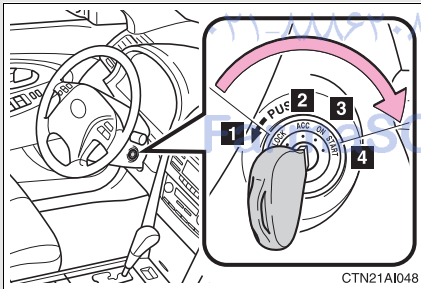

##### 1 "LOCK"

تلفن شبانه روزی: ۰۲۱-۸۸۸۷۳۰۰۰  
www.ardas.com

The steering wheel is locked and the key can be removed. (Vehicles with an automatic transmission: The key can be removed only when the shift lever is in "P".)

##### 2 "ACC"

Some electrical components such as the audio system can be used.

##### 3 "ON"

All electrical components can be used.

##### 4 "START"

For starting the engine.

### ■ Turning the key from “ACC” to “LOCK”

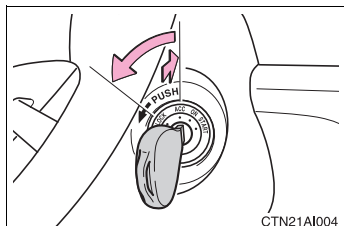

**STEP 1** Shift the shift lever to N (manual transmission) or P (automatic transmission). (→P. 138, 142)

**STEP 2** Push in the key and turn to the “LOCK” position.

### ■ Steering lock release

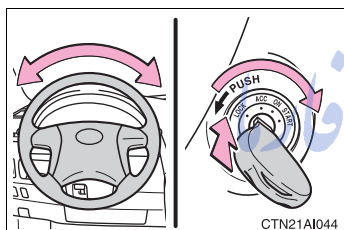

When starting the engine, the engine switch may seem stuck in the “LOCK” position. To free it, turn the key while turning the steering wheel slightly in either direction.

### ■ If the engine does not start

The engine immobilizer system may not have been deactivated. (→P. 80)

### ■ Key reminder buzzer

A buzzer sounds if the driver’s door is opened while the key is in the “LOCK” position to remind you to remove the key.

## ⚠ CAUTION

### ■ When starting the engine

Always start the engine while sitting in the driver's seat. Do not depress the accelerator while starting the engine under any circumstances.

Doing so may cause an accident resulting in death or serious injury.

### ■ Caution when driving

Do not turn the engine switch to the “LOCK” position while driving. If, in an emergency, you must turn the engine off while the vehicle is moving, turn the key only to the “ACC” position.

 NOTICE**■ To prevent battery discharge**

Do not leave the key in the “ACC” or “ON” position for long periods if the engine is not running.

**■ When starting the engine**

- Do not crank for more than 30 seconds at a time. This may overheat the starter and wiring systems.
- Do not race a cold engine.
- If the engine becomes difficult to start or stalls frequently, have the engine checked immediately.

امداد خودرو فارما

تلفن شبانه روزی: ۰۲۱-۸۸۶۲۰۸۵

FarmaSOS.com

## 2-1. Driving procedures

# Automatic transmission \*

Select a shift position appropriate for the driving conditions.

### ■ Shifting the shift lever

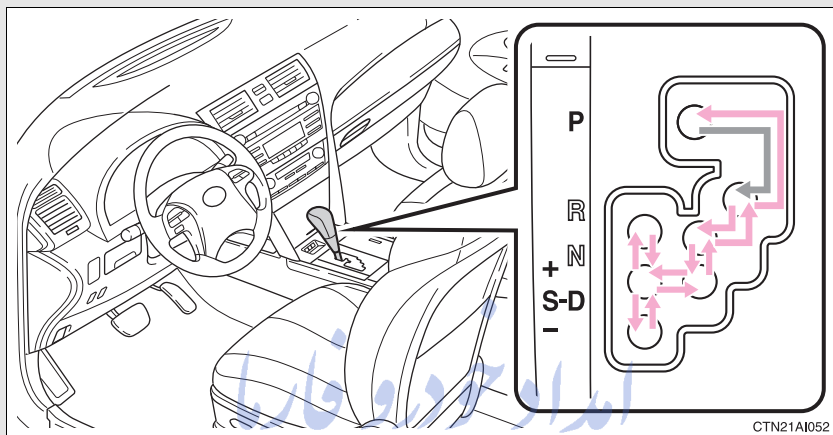

Vehicles with smart key system:

While the “ENGINE START STOP” switch is in IGNITION ON mode, depress the brake pedal and move the shift lever.

Vehicles without smart key system:

While the engine switch is in the “ON” position, depress the brake pedal and move the shift lever.

\*: If equipped

## ■ Shift position uses

Shift position	Function
P	Parking the vehicle or starting the engine
R	Reversing
N	Neutral
D	Normal driving <sup>*1</sup>
S	S mode driving <sup>*2</sup> (→P. 139)

- \*1: Shifting to the D position allows the system to select a gear suitable for the driving conditions. Setting the shift lever to the D position is recommended for normal driving.
- \*2: Selecting shift ranges using S mode restricts the upper limit of the possible gear ranges, controls engine braking force, and prevents unnecessary upshifting.

## Changing shift ranges in S mode

When the shift lever is in the S position, the shift lever can be operated as follows:

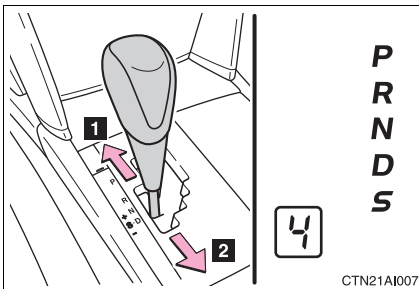

- 1 Upshifting
- 2 Downshifting

The initial shift range in S mode is set automatically to 5 or 4 according to vehicle speed. However, the initial shift range may be set to 3 if AI-SHIFT has operated while the shift lever was in the D position. (→P. 141)



### ■ Shift ranges and their functions

Shift range	Function
6	A gear between 1 and 6 is automatically selected according to vehicle speed and driving conditions.
5	A gear between 1 and 5 is automatically selected according to vehicle speed and driving conditions.
4	A gear between 1 and 4 is automatically selected according to vehicle speed and driving conditions.
3	A gear between 1 and 3 is automatically selected according to vehicle speed and driving conditions.
2	A gear between 1 and 2 is automatically selected according to vehicle speed and driving conditions.
1	Setting the gear at 1.

A lower shift range will provide greater engine braking force than a higher shift range.

### ■ Downshifting restrictions

To help ensure safety and driving performance, downshifting operation may sometimes be restricted. In some circumstances, downshifting may not be possible even when the shift lever is operated. (The warning buzzer will sound twice.)

### ■ When driving with the cruise control system

Engine braking will not occur during shift range selection in the D position or S mode, even when downshifting to range 5 or 4. (→P. 166)

### ■ If the shift lever cannot be shifted from P

→P. 467

■ **If the “S” indicator does not come on even after shifting the shift lever to S**

This may indicate a malfunction in the automatic transmission system. Have the vehicle inspected by your Toyota dealer immediately.

(In this situation, the vehicle will operate as if the shift lever is in D.)

■ **S mode**

- When the shift range is 5 or lower, holding the shift lever toward “+” sets the shift range to 6.
- To prevent the engine from over-revving, upshifting may automatically occur.
- To protect the automatic transmission, a function is adopted that automatically shifts to the top range when the temperature is too hot.

■ **AI-SHIFT**

The AI-SHIFT automatically shifts the gear to the suitable position according to the driver performance and driving conditions.

The AI-SHIFT automatically operates when the shift lever is in the D position. (Shifting the shift lever to the S position cancels the function.)

تلفن شبانه روزی: ۰۲۱-۸۸۶۲۰۸۵

FarmaSOS.com

## 2-1. Driving procedures

# Manual transmission\*

### ■ Shifting the shift lever

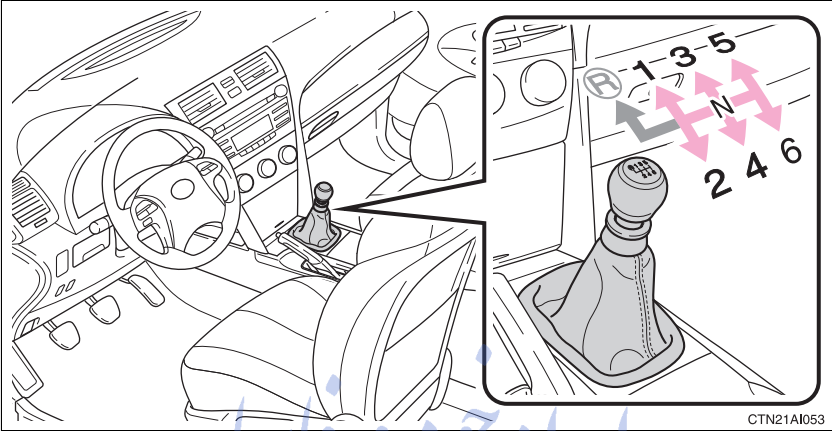

Fully depress the clutch pedal before operating the shift lever, and then release it slowly.

### ■ Shifting the shift lever to R

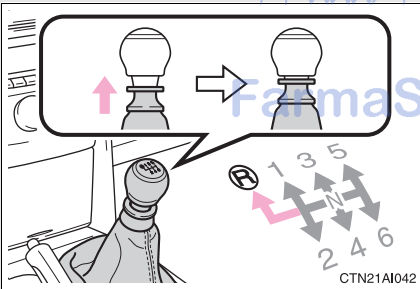

Shift the shift lever to the R position while lifting up the ring section.

\*: If equipped

### ■ Maximum allowable speeds

Observe the following maximum allowable speeds in each gear when maximum acceleration is necessary.

mph (km/h)

Shift position	Maximum speed
1	32 (52)
2	56 (91)
3	83 (135)
4	118 (191)
5	130 (210)

2

When driving

### ⚠ NOTICE

#### ■ To prevent damage to the transmission

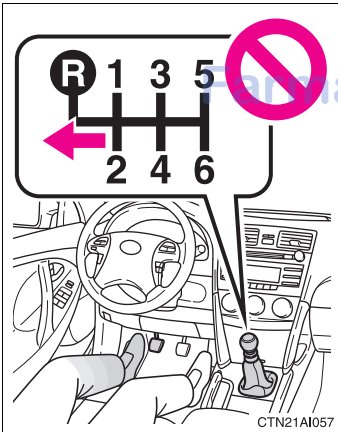

- Do not shift the shift lever to R without depressing the clutch pedal.

- Do not lift up the ring section except when shifting the lever to R.
- Shift the shift lever to R only when the vehicle is stationary.

امداد خودرو فارما

تلفن شبانه روزی: ۰۲۱-۸۸۶۲۰۸۵  
FarmaSOS.com

## 2-1. Driving procedures

### Turn signal lever

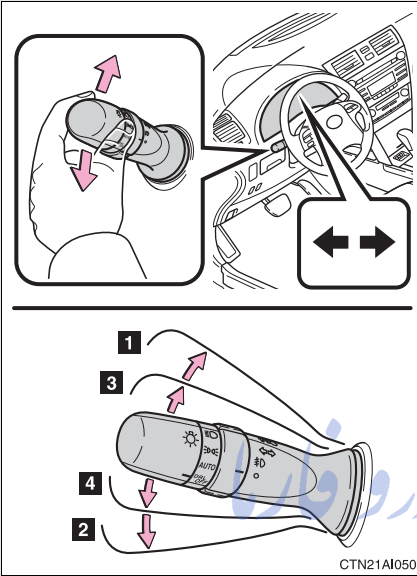

- 1 Right turn
- 2 Left turn
- 3 Move and hold the lever partway to signal a lane change.

The right hand signal will flash until you release the lever.

- 4 Move and hold the lever partway to signal a lane change.

The left hand signal will flash until you release the lever.

تلفن شبانه روزی: ۰۲۱-۸۸۶۲۰۸۵

#### ■ Turn signals can be operated when

- ▶ Vehicles with smart key system  
The "ENGINE START STOP" switch is in ON mode.
- ▶ Vehicles without smart key system  
The engine switch is in the "ON" position.

#### ■ If the indicators flash faster than usual

Check that a light bulb in the front or rear turn signal lights has not burned out.

## 2-1. Driving procedures

### Parking brake

#### ► Manual transmission

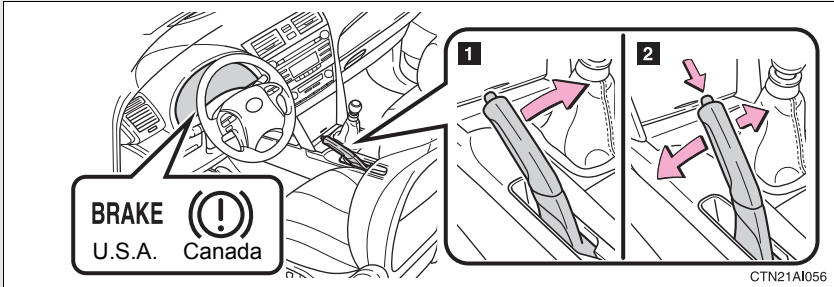

#### 1 Sets the parking brake

Fully apply the parking brake while depressing the brake pedal.

#### 2 Releases the parking brake

Slightly raise the lever and lower it completely while pressing the button.

#### ► Automatic transmission

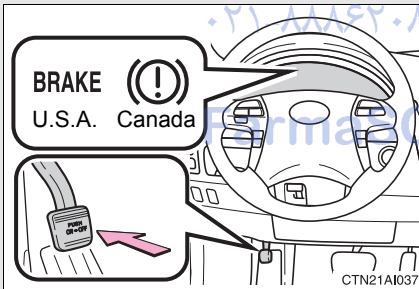

#### Sets the parking brake\*

(Depressing the pedal again releases the parking brake.)

\*: Fully depress the parking brake pedal with your left foot while depressing the brake pedal with your right foot.

#### ⚠ NOTICE

##### ■ Before driving

Fully release the parking brake.

Driving the vehicle with the parking brake set will lead to brake components overheating, which may affect braking performance and increase brake wear.

## 2-1. Driving procedures

### Horn

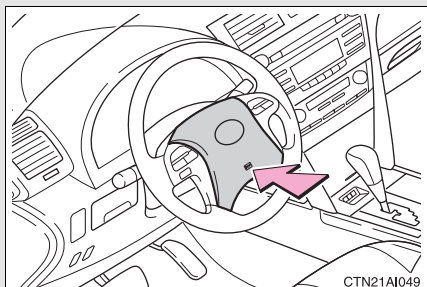

To sound the horn, press on or close to the  mark.

#### ■ After adjusting the steering wheel

Make sure that the steering wheel is securely locked.

The horn may not sound if the steering wheel is not securely locked.

(→P. 65)

تلفن شبانه روزی: ۰۲۱-۸۸۶۲۰۸۵

FarmaSOS.com

## 2-2. Instrument cluster Gauges and meters

### ► Vehicles with multi-information display

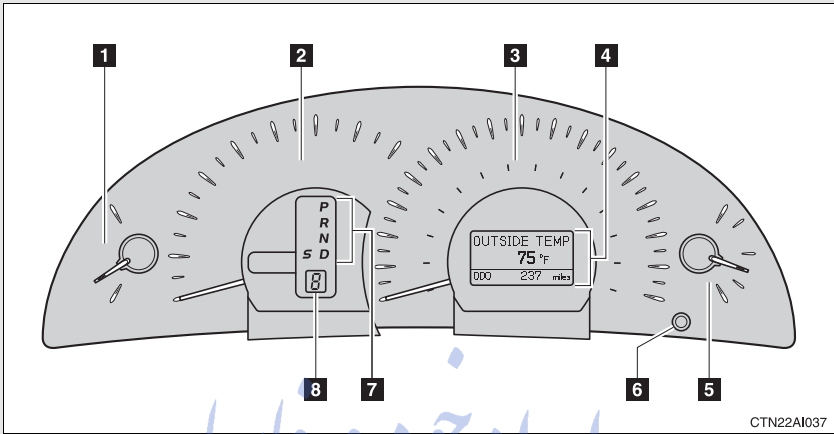

Vehicles with smart key system: The following gauges, meters and displays illuminate when the “ENGINE START STOP” switch is in IGNITION ON mode.

Vehicles without smart key system: The following gauges, meters and displays illuminate when the engine switch is in the “ON” position.

- 1** Engine coolant temperature gauge  
Displays the engine coolant temperature.
- 2** Tachometer  
Displays the engine speed in revolutions per minute.
- 3** Speedometer  
Displays the vehicle speed.
- 4** Multi-information display  
→P. 155
- 5** Fuel gauge  
Displays the quantity of fuel remaining in the tank.



**6** Odometer/trip meter/instrument panel light control and trip meter reset button

Switches between odometer and trip meter displays. Pressing and holding the button will reset the trip meter when the trip meter is being displayed. To adjust the brightness of the instrument panel light, turn the button. (→P. 150)

**7** Automatic transmission shift position indicator lights

→P. 138

**8** Automatic transmission shift range display

→P. 138

امداد خودرو فارما

تلفن شبانه روزی: ۰۲۱-۸۸۸۶۲۰۸۵

FarmaSOS.com

► Vehicles without multi-information display

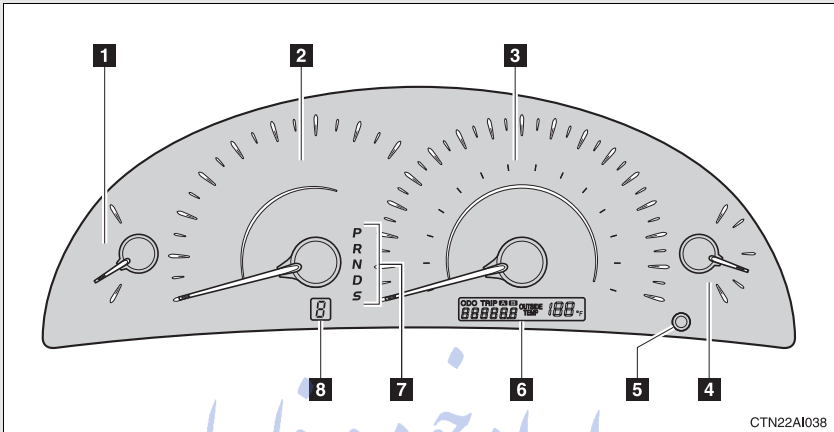

The following gauges, meters and displays illuminate when the engine switch is in the “ON” position.

- 1** Engine coolant temperature gauge  
Displays the engine coolant temperature.
- 2** Tachometer  
Displays the engine speed in revolutions per minute.
- 3** Speedometer  
Displays the vehicle speed.
- 4** Fuel gauge  
Displays the quantity of fuel remaining in the tank.
- 5** Odometer/trip meter/instrument panel light control and trip meter reset button  
Switches between odometer and trip meter displays. Pressing and holding the button will reset the trip meter when the trip meter is being displayed. To adjust the brightness of the instrument panel light, turn the button. (→P. 150)

**6** Odometer, trip meter and outside temperature display

Odometer: Displays the total distance the vehicle has been driven.

Trip meter: Displays the distance the vehicle has been driven since the meter was last reset. Trip meters A and B can be used to record and display different distances independently.

Outside temperature: Displays the outside temperature.

**7** Automatic transmission shift position indicator lights

→P. 138

**8** Automatic transmission shift range display

→P. 138

**Instrument panel light control**

The brightness of the instrument panel lights can be adjusted.

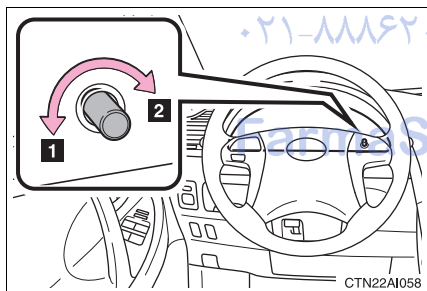

**1** Darker

**2** Brighter

When the headlight switch is turned to on, the brightness will be reduced slightly unless the control dial is turned fully clockwise.

**⚠ NOTICE**

**■ To prevent damage to the engine and its components**

- Do not let the indicator needle of the tachometer enter the red zone, which indicates the maximum engine speed.
- The engine may be overheating if the engine coolant temperature gauge is in the red zone (H). In this case, immediately stop the vehicle in a safe place, and check the engine after it has cooled completely. (→P. 475)

## 2-2. Instrument cluster

### Indicators and warning lights

The indicator and warning lights on the instrument cluster and center panel inform the driver of the status of the vehicle's various systems.

► Instrument cluster (vehicles with multi-information display)

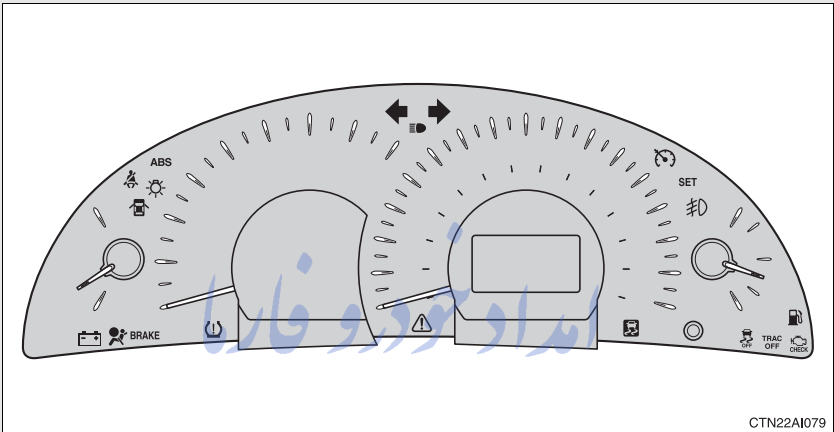

► Instrument cluster (vehicles without multi-information display)

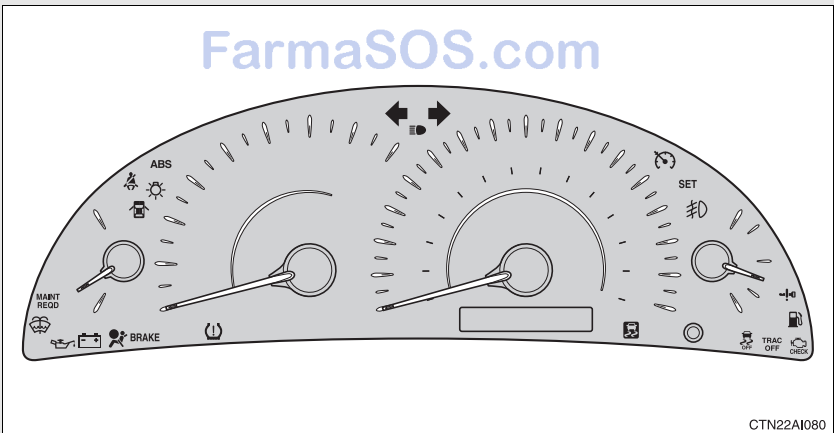

► Center panel

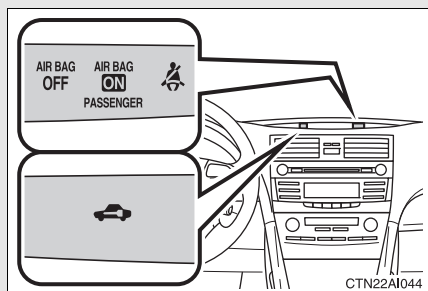

امداد خودرو فارما

تلفن شبانه روزی: ۰۲۱-۸۸۸۶۲۰۸۵

FarmaSOS.com

## ■ Indicators

The indicators inform the driver of the operating state of the vehicle's various systems.



Turn signal indicator  
(→P. 144)



(U.S.A.)

Headlight indicator  
(→P. 159)



Headlight high beam indicator  
(→P. 160)



(CANADA)

Tail light indicator  
(→P. 159)



\*

Slip indicator  
(→P. 170)



(if equipped)

Front fog light indicator  
(→P. 163)



\*

VSC OFF indicator  
(→P. 171)



\*

SRS airbag on-off indicator  
(→P. 99)



\*

"TRAC OFF" indicator  
(→P. 171)



Cruise control indicator  
(→P. 166)



Engine immobilizer/  
alarm system indicator  
(→P. 80, 82)



Cruise control set indicator  
(→P. 166)

## ■ Warning lights

Warning lights inform the driver of malfunctions in any of the vehicle's systems. (→P. 432)

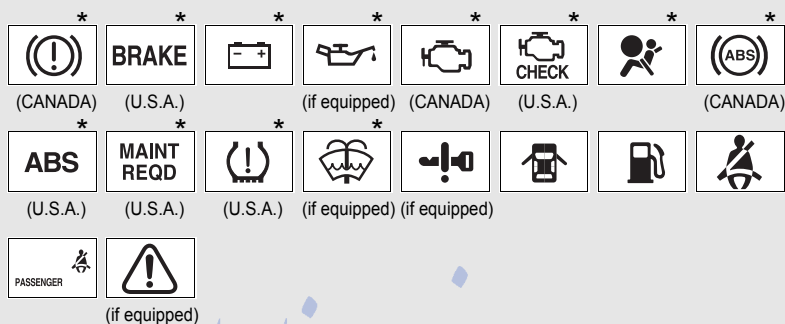

\*: These lights turn on when the “ENGINE START STOP” switch is turned to IGNITION ON mode (vehicles with smart key system) or the engine switch is turned to the “ON” position (vehicles without smart key system) to indicate that a system check is being performed. They will turn off after the engine is started, or after a few seconds. There may be a malfunction in a system if a light does not come on, or if the lights do not turn off. Have the vehicle inspected by your Toyota dealer for details.

## ⚠ CAUTION

### ■ If a safety system warning light does not come on

Should a safety system light such as the ABS or the SRS airbag warning light not come on when you start the engine, this could mean that these systems are not available to help protect you in an accident, which could result in death or serious injury. Have the vehicle inspected by your Toyota dealer immediately if this occurs.

# Multi-information display\*

The multi-information display presents the driver with a variety of driving-related data, including the outside temperature.

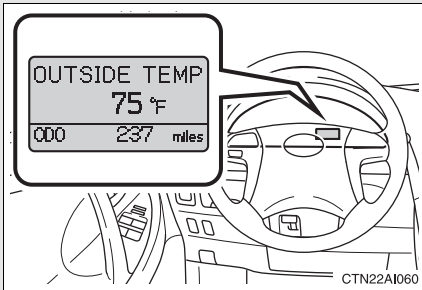

- Outside temperature display (→P. 156)

Indicates the outside temperature.

- Trip information (→P. 156)

Displays driving range, fuel consumption and other cruising-related information.

- Warning messages (→P. 444)

Automatically displayed when a malfunction occurs in one of the vehicle's systems.

- Odometer and trip meter display

Odometer: Displays the total distance the vehicle has been driven.

Trip meter: Displays the distance the vehicle has been driven since the meter was last reset. Trip meters A and B can be used to record and display different distances independently.



## Switch the display

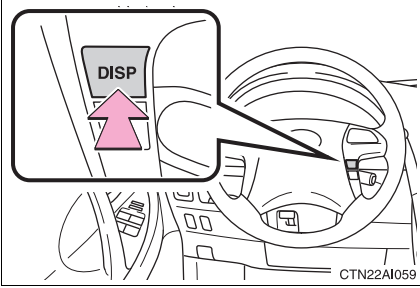

Display items can be switched by pressing the “DISP” button.

The display will return to the outside temperature display when the “DISP” button is pressed and held.

### ● Outside temperature

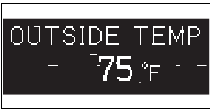

Displays the outside air temperature.

The temperature range that can be displayed is from -40°F (-40°C) to 122°F (50°C).

### ● Cruising range



Displays the estimated maximum distance that can be driven with the quantity of fuel remaining.

- This distance is computed based on your average fuel consumption. As a result, the actual distance that can be driven may differ from that displayed.
- When only a small amount of fuel is added to the tank, the display may not be updated.

### ● Average fuel consumption after refueling

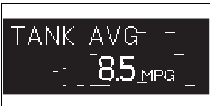

Displays the average fuel consumption since the vehicles was last refueled.

- Driving distance



Displays the driving distance since the engine was started.

- Average vehicle speed



Displays the average vehicle speed since the engine was started.

- Cruise information off



Displays the odometer and trip meters only.

- Zoom display of odometer and trip meter

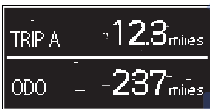

Displays the odometer and one of the trip meters simultaneously.

## ■ Outside temperature display

In the following situations, the correct outside temperature may not be displayed, or the display may take longer than normal to change.

- When stopped, or driving at low speeds (less than 12 mph [20 km/h])
- When the outside temperature has changed suddenly (at the entrance/ exit of a garage, tunnel, etc.)

 NOTICE

■ **The multi-information display at low temperatures**

Allow the interior of the vehicle to warm up before using the liquid crystal information display. At extremely low temperatures, the information display monitor may respond slowly, and display changes may be delayed.

امداد خودرو فارما

تلفن شبانه روزی: ۰۲۱-۸۸۸۶۲۰۸۵

FarmaSOS.com

## 2-3. Operating the lights and wipers

### Headlight switch

The headlights can be operated manually or automatically.

► For U.S.A.

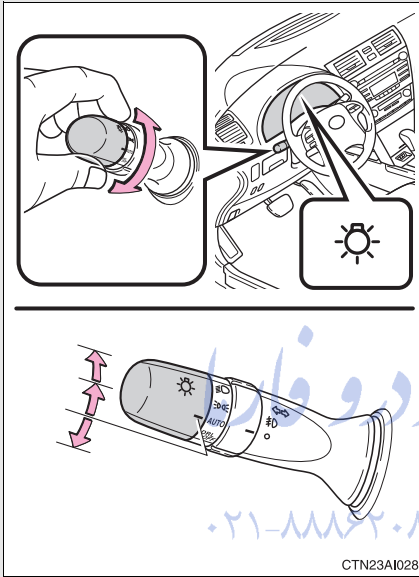

The side marker, parking, tail, license plate and instrument panel lights turn on.



The headlights and all lights listed above turn on.

**AUTO**

The headlights and parking lights turn on and off automatically. (When the "ENGINE START STOP" switch or the engine switch is in ON)

**DRL OFF**

Daytime running light system is off.

FarmaSOS.com

► For Canada

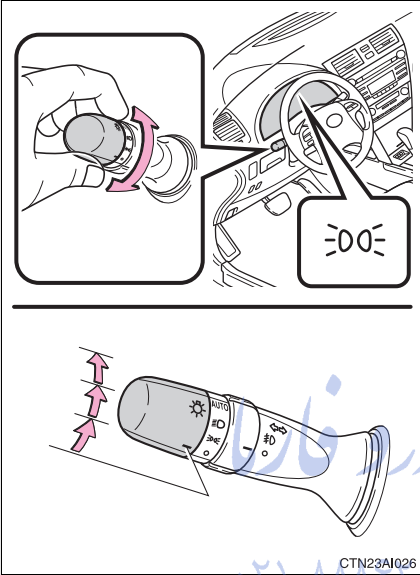

The side marker, parking, tail, license plate and instrument panel lights turn on.



The headlights and all lights listed above turn on.

**AUTO**

The headlights and parking lights turn on and off automatically. (When the “ENGINE START STOP” switch or the engine switch is in ON)

**Turning on the high beam headlights**

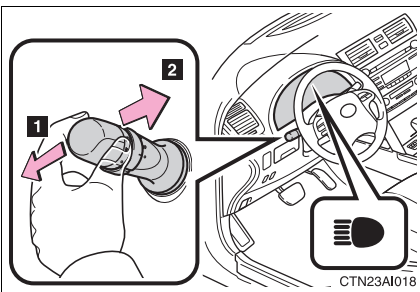

**1** With the headlights on, push the lever forward to turn on the high beams.

Pull the lever back to the center position to turn the high beams off.

**2** Pull the lever toward you to turn on the high beams.

Release the lever to turn them off. You can flash the high beams with the headlights on or off.

### ■ The headlights can be operated automatically when

- ▶ Vehicles with smart key system

The “ENGINE START STOP” switch is in IGNITION ON mode.

- ▶ Vehicles without smart key system

The engine switch is in the “ON” position.

### ■ Daytime running light system

To make your vehicle more visible to other drivers, the headlights turn on automatically (at a reduced intensity) whenever the engine is started and the parking brake is released. Daytime running lights are not designed for use at night.

For U.S.A.: Daytime running lights can be turned off by operating the switch.

### ■ Headlight control sensor

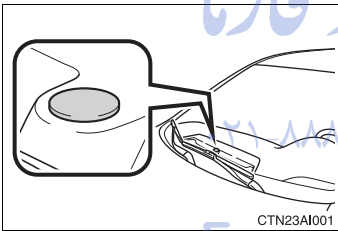



The sensor may not function properly if an object is placed on the sensor, or anything that blocks the sensor is affixed to the windshield.

Doing so interferes with the sensor detecting the level of ambient light and may cause the automatic headlight system to malfunction.

### ■ Automatic light off system

#### ▶ Vehicles with smart key system

- When the headlights are on: The headlights and tail lights turn off 30 seconds after all doors are closed with the “ENGINE START STOP” switch OFF. (The lights turn off immediately if  on the key is pressed after all doors are locked.)
- When only the tail lights are on: The tail lights turn off automatically if the “ENGINE START STOP” switch is turned OFF and the driver’s door is opened.



To turn the lights on again, turn the “ENGINE START STOP” switch to IGNITION ON mode, or turn the headlight switch off and then back to  or

 position.

If any of the doors or trunk lid is kept open, the lights automatically turn off after 20 minutes.

#### ▶ Vehicles without smart key system

- When the headlights are on: The headlights and tail lights turn off 30 seconds after all doors are closed with the engine switch OFF. (Vehicles with wireless remote control: The lights turn off immediately if  on the key is pressed after all doors are locked.)
- When only the tail lights are on: The tail lights turn off automatically if the engine switch is turned OFF and the driver’s door is opened.

To turn the lights on again, turn the engine switch to the “ON” position, or turn the headlight switch off and then back to  or  position.

If any of the doors or trunk lid is kept open, the lights automatically turn off after 20 minutes.

### ■ Customization that can be configured at Toyota dealer

Settings (e.g. Light sensor sensitivity) can be changed.  
(Customizable features →P. 510)

#### NOTICE

#### ■ To prevent battery discharge

Do not leave the lights on longer than necessary when the engine is not running.

## 2-3. Operating the lights and wipers

### Fog light switch\*

The fog lights improve visibility in difficult driving conditions, such as in rain or fog. They can be turned on only when the headlights are on low beam.

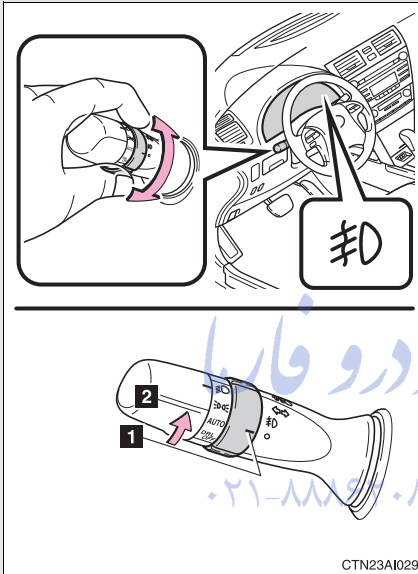

- 1 Off
- 2 Front fog lights on



## 2-3. Operating the lights and wipers

### Windshield wipers and washer

Wiper intervals can be adjusted for intermittent operation.

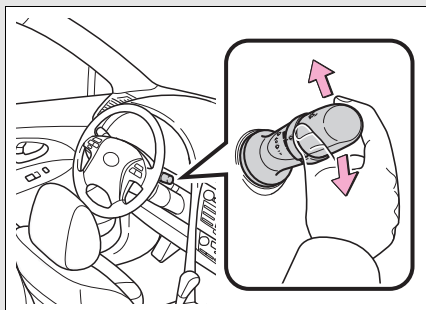

- 1 Intermittent windshield wiper operation
- 2 Low speed windshield wiper operation
- 3 High speed windshield wiper operation
- 4 Temporary operation

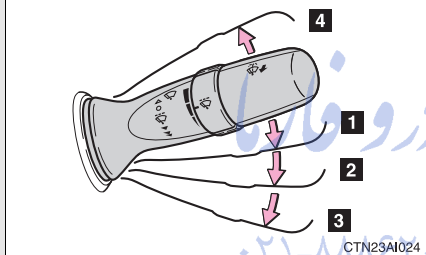

- 5 Increases the intermittent windshield wiper frequency
- 6 Decreases the intermittent windshield wiper frequency

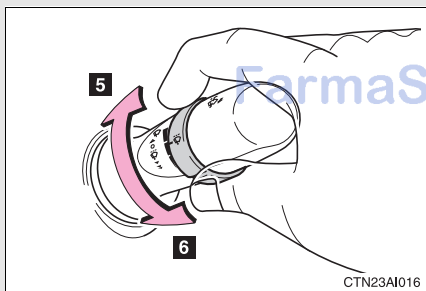

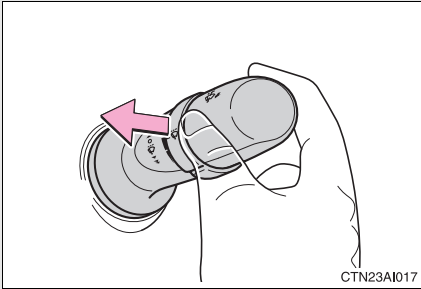

### Wash/wipe operation

Wipers operate automatically.

2

When driving

#### ■ The windshield wiper and washers can be operated when

- ▶ Vehicles with smart key system

The "ENGINE START STOP" switch is in IGNITION ON mode.

- ▶ Vehicles without smart key system

The engine switch is in the "ON" position.

#### ■ If no windshield washer fluid sprays: تلفن شبانه روزی: ۰۲۱-۸۸۸۸۸۸۸۸

Check that the washer nozzles are not blocked and if there is washer fluid in the windshield washer fluid reservoir.

FarmaSOS.com

#### ⚠ NOTICE

##### ■ When the windshield is dry

Do not use the wipers, as they may damage the windshield.

##### ■ When there is no washer fluid spray from the nozzle

Damage to the washer fluid pump may be caused if the lever is pulled toward you and held continually.

##### ■ When a nozzle becomes blocked

Do not try to clear it with a pin or other object. The nozzle will be damaged.

## 2-4. Using other driving systems

# Cruise control

Use the cruise control to maintain a set speed without using the accelerator.

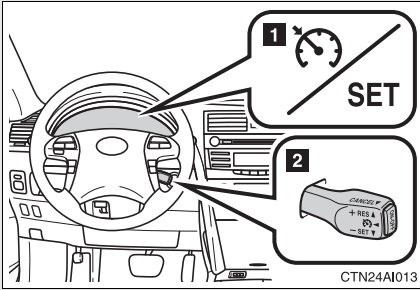

1 Indicators

2 Cruise control switch

### ■ Setting the vehicle speed

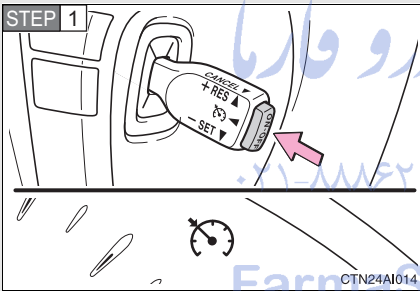

Turn the "ON-OFF" button on.

At this time, the cruise control indicator will come on.

Press the button once more to deactivate the cruise control.

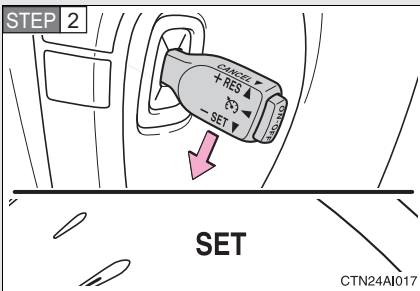

Accelerate or decelerate to the desired speed and push the lever down to set the cruise control speed.

At this time, the cruise control set indicator will come on.

### ■ Adjusting the speed setting

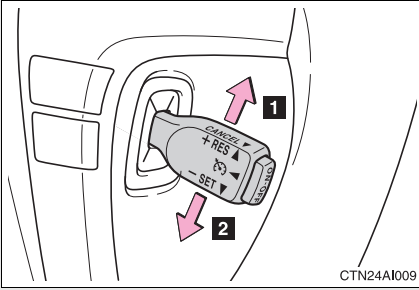

**1** Increase speed

**2** Decrease speed

Hold the lever until the desired speed setting is obtained.

Fine adjustment of the set speed (approximately 1.0 mph [1.6 km/h]) can be made by lightly pushing the lever up or down and releasing it.

### ■ Canceling and resuming regular acceleration

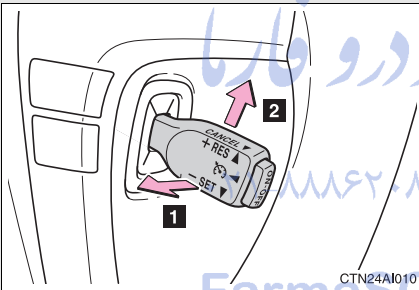

**1** Cancel

Pull the lever towards you to cancel cruise control.

The speed setting is also canceled when the brakes are applied or the clutch pedal (manual transmission) is depressed.

**2** Resume

To resume cruise control and return to the set speed, push the lever up.

■ **Cruise control can be set when**

- Automatic transmission:  
The shift lever is in D, 4, 5 or 6 range of S.
- Vehicle speed is above 25 mph (40 km/h).

■ **Accelerating**

The vehicle can be accelerated normally. After acceleration, the set speed resumes.

■ **Automatic cruise control cancellation**

The set speed is automatically canceled in any of the following situations.

- Actual vehicle speed falls more than 10 mph (16 km/h) below the preset vehicle speed.  
At this time, the memorized set speed is not retained.
- Actual vehicle speed is below 25 mph (40 km/h).
- VSC is activated.

■ **If the cruise control indicator light flashes**

Press the "ON-OFF" button once to deactivate the system, and then press the button again to reactivate the system.

If the cruise control speed cannot be set or if the cruise control cancels immediately after being activated, there may be a malfunction in the cruise control system. Contact your Toyota dealer and have your Toyota inspected.

**⚠ CAUTION****■ To avoid operating the cruise control by mistake**

Keep the "ON-OFF" button off when not in use.

**■ Situations unsuitable for cruise control**

Do not use cruise control in any of the following situations.

Doing so may result in control of the vehicle being lost and could cause an accident resulting in death or serious injury.

- In heavy traffic
- On roads with sharp bends
- On winding roads
- On slippery roads, such as those covered with rain, ice or snow
- On steep hills

امداد خودرو فارما

تلفن شبانه روزی: ۰۲۱-۸۸۶۲۰۸۵

FarmaSOS.com

## 2-4. Using other driving systems

### Driving assist systems

To help enhance driving safety and performance, the following systems operate automatically in response to various driving situations. Be aware, however, that these systems are supplementary and should not be relied upon too heavily when operating the vehicle.

#### ■ ABS (Anti-lock Brake System)

Helps to prevent wheel lock when the brakes are applied suddenly, or if the brakes are applied while driving on a slippery road surface.

#### ■ Brake assist

Generates an increased level of braking force after the brake pedal is depressed, when the system detects a panic stop situation.

#### ■ VSC (Vehicle Stability Control)

Helps the driver to control skidding when swerving suddenly or turning on slippery road surfaces.

#### ■ TRAC (Traction Control)

Maintains drive power and prevents the front wheels from spinning when starting the vehicle or accelerating on slippery roads.

#### When VSC and TRAC are operating

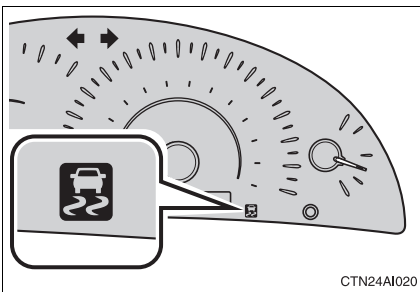

If the vehicle is in danger of slipping or the front wheels spin, the indicator flashes to indicate that VSC/TRAC have been engaged.

A buzzer (intermittent) sounds to indicate that VSC is operating.

## To disable TRAC and/or VSC

If the vehicle gets stuck in fresh snow or mud, TRAC and VSC may reduce power from the engine to the wheels. You may need to turn the system off to enable you to rock the vehicle in order to free it.

### ■ Turning off TRAC

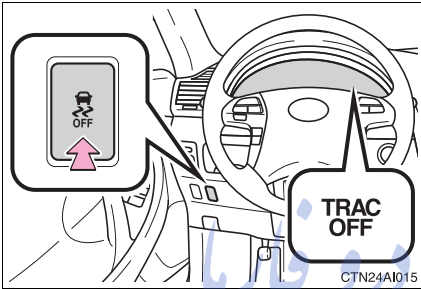

Quickly push and release the button to turn off TRAC.

The “TRAC OFF” indicator light should come on.

Push the button again to turn the system back on.

### ■ Turning off TRAC and VSC

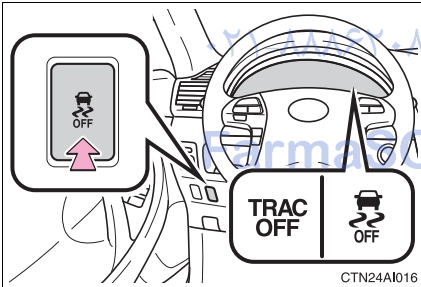

Push and hold the button for more than 3 seconds while the vehicle is stopped to turn off TRAC and VSC.

The “TRAC OFF” and VSC OFF indicator lights should come on.

Push the button again to turn the system back on.



■ **Automatic reactivation of TRAC and VSC**

- ▶ Vehicles with smart key system

Turning the “ENGINE START STOP” switch OFF after turning off the TRAC and VSC systems will automatically re-enable them.

- ▶ Vehicles without smart key system

Turning the engine switch OFF after turning off the TRAC and VSC systems will automatically re-enable them.

■ **Automatic TRAC reactivation**

If only the TRAC system is turned off, the TRAC system will turn on when vehicle speed increases.

■ **Automatic TRAC and VSC reactivation**

If the TRAC and VSC systems are turned off, the systems will not turn on even when vehicle speed increases.

■ **Sounds and vibrations caused by ABS, brake assist, VSC and TRAC**

- A sound may be heard from the engine compartment when the engine is started or just after the vehicle begins to move. This sound does not indicate that a malfunction has occurred in any of these systems.
- Any of the following conditions may occur when the above systems are operating. None of these indicates that a malfunction has occurred.
  - Vibrations may be felt through the vehicle body and steering.
  - A motor sound may be heard after the vehicle comes to a stop.
  - The brake pedal may pulsate slightly after ABS is activated.
  - The brake pedal may move down slightly after ABS is activated.

■ **If the slip indicator comes on...**

It may indicate a malfunction in the VSC and TRAC. Contact your Toyota dealer.

 **CAUTION**
**■ ABS does not operate effectively when**

- Tires with inadequate gripping ability are used (such as excessively worn tires on a snow covered road).
- The vehicle hydroplanes while driving at high speed on the wet or slick road.

**■ Stopping distance when ABS is operating on the wet or slick roads**

ABS is not designed to shorten the vehicle's stopping distance. Always maintain a safe distance from the vehicle in front of you in the following situations.

- When driving on dirt, gravel or snow-covered roads
- When driving with tire chains
- When driving over bumps in the road
- When driving over roads with potholes or uneven roads

**■ TRAC may not operate effectively when**

Directional control and power may not be achievable while driving on slippery road surfaces, even if the TRAC system is operating.

Do not drive the vehicle in conditions where stability and power may be lost.

 CAUTION

■ **When VSC is activated**

The slip indicator light flashes and a warning buzzer sounds. Always drive carefully. Reckless driving may cause an accident. Exercise particular care when the indicator light flashes and a buzzer sounds.

■ **When TRAC and VSC are off**

Be especially careful and drive at a speed appropriate to the road conditions. As these are systems to ensure vehicle stability and driving force, do not turn off TRAC and VSC unless necessary.

■ **Replacing tires**

Make sure that all tires are of the same size, brand, tread pattern and total load capacity. In addition, make sure that the tires are inflated to the recommended tire pressure level.

The ABS and VSC system will not function correctly if different tires are fitted on the vehicle.

Contact your Toyota dealer for further information when replacing tires or wheels.

■ **Handling of tires and suspension**

Using tires with any kind of problem or modifying the suspension will affect the driving assist systems, and may cause the system to malfunction.

# Cargo and luggage

**Take notice of the following information about storage precautions, cargo capacity and load.**

- Stow cargo and luggage in the trunk whenever possible.
- Be sure all items are secured in place.
- Be careful to keep the vehicle level. Placing the weight as far forward as possible helps maintain vehicle balance.
- For better fuel economy, do not carry unnecessary weight.

### Capacity and distribution

Cargo capacity depends on the total weight of the occupants.

(Cargo capacity) = (Total load capacity) - (Total weight of occupants)

#### Steps for Determining Correct Load Limit —

- (1) Locate the statement “The combined weight of occupants and cargo should never exceed XXX kg or XXX lbs.” on your vehicle’s placard.
- (2) Determine the combined weight of the driver and passengers that will be riding in your vehicle.
- (3) Subtract the combined weight of the driver and passengers from XXX kg or XXX lbs.
- (4) The resulting figure equals the available amount of cargo and luggage load capacity.

For example, if the XXX amount equals 1400 lbs. and there will be five 150 lb. passengers in your vehicle, the amount of available cargo and luggage load capacity is 650 lbs. (1400 - 750 (150 × 5) = 650 lbs.)

- (5) Determine the combined weight of luggage and cargo being loaded on the vehicle. That weight may not safely exceed the available cargo and luggage load capacity calculated in Step 4.

- (6) If your vehicle will be towing a trailer, load from your trailer will be transferred to your vehicle. Consult this manual to determine how this reduces the available cargo and luggage load capacity of your vehicle. (→P. 183)

### Example on your vehicle

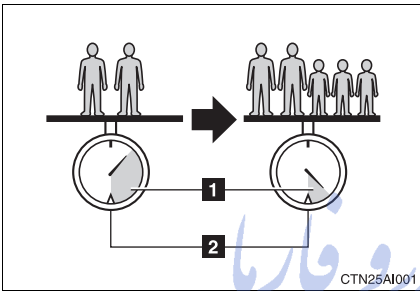

- 1 Cargo capacity
- 2 Total load capacity

When 2 people with the combined weight of 366 lb. (166 kg) are riding in your vehicle, which has a total load capacity of 900 lb. (410 kg), the available amount of cargo and luggage load capacity will be as follows:

$$900 \text{ lb.} - 366 \text{ lb.} = 534 \text{ lb.} \quad (410 \text{ kg} - 166 \text{ kg} = 244 \text{ kg})$$

In this condition, if 3 more passengers with the combined weight of 388 lb. (176 kg) get on, the available cargo and luggage load will be reduced as follows:

$$534 \text{ lb.} - 388 \text{ lb.} = 146 \text{ lb.} \quad (244 \text{ kg} - 176 \text{ kg} = 68 \text{ kg})$$

As shown in the above example, if the number of occupants increases, the cargo and luggage load will be reduced by an amount that equals the increased weight due to the additional occupants. In other words, if an increase in the number of occupants causes an excess of the total load capacity (combined weight of occupants plus cargo and luggage load), you must reduce the cargo and luggage on your vehicle.

 CAUTION

### ■ Storage precautions

Observe the following precautions.

Failing to do so may result in death or serious injury.

- Vehicles with fold-down type rear seat: To prevent cargo and luggage from sliding forward during braking, do not stack anything in the enlarged trunk. Keep cargo and luggage low, as close to the floor as possible.
- Vehicles with fold-down type rear seat: Never allow anyone to ride in the enlarged trunk. It is not designed for passengers. They should ride in their seats with their seat belts properly fastened. Otherwise, they are much more likely to suffer death or serious bodily injury, in the event of sudden braking, sudden swerving or a collision.
- Do not place cargo or luggage in or on the following locations as the item may get under the clutch, brake or accelerator pedal and prevent the pedals from being depressed properly, block the driver's vision, or hit the driver or passengers, causing an accident.
  - Driver's feet
  - Front passenger or rear seats (when stacking items)
  - Package tray
  - Instrument panel
  - Dashboard
- Secure all items in the occupant compartment, as they may shift and injure someone during sudden braking, sudden swerving or an accident.

### ■ Capacity and distribution

- Do not exceed the maximum axle weight rating or the total vehicle weight rating.
- Even if the total load of occupant's weight and the cargo load is less than the total load capacity, do not apply the load unevenly. Improper loading may cause deterioration of steering or braking control which may cause death or serious injury.

## 2-5. Driving information

### Vehicle load limits

Vehicle load limits include total load capacity, seating capacity, towing capacity and cargo capacity.

■ **Total load capacity: 900 lb. (410 kg)**

Total load capacity means the combined weight of occupants, cargo and luggage.

■ **Seating capacity: 5 occupants (Front 2, Rear 3)**

Seating capacity means the maximum number of occupants whose estimated average weight is 150 lb. (68 kg) per person.

■ **Towing capacity: 1000 lb. (453 kg)**

■ **Cargo capacity**

Cargo capacity may increase or decrease depending on the weight and the number of occupants.

---

■ **Total load capacity and seating capacity**

These details are also described on the tire and loading information label. (→P. 392)

 **CAUTION**

■ **Overloading the vehicle**

Do not overload the vehicle.

It may not only cause damage to the tires, but also degrade steering and braking ability, resulting in an accident.

### Winter driving tips

Carry out the necessary preparations and inspections before driving the vehicle in winter. Always drive the vehicle in a manner appropriate to the prevailing weather conditions.

#### ■ Pre-winter preparations

- Use fluids that are appropriate to the prevailing outside temperatures.
  - Engine oil
  - Engine coolant
  - Washer fluid
- Have a service technician inspect the level and specific gravity of battery electrolyte.
- Have the vehicle fitted with four snow tires or purchase a set of tire chains for the front tires.

Ensure that all tires are the same size and brand, and that chains match the size of the tires.

#### ■ Before driving the vehicle

Perform the following according to the driving conditions.

- Do not try to forcibly open a window or move a wiper that is frozen. Pour warm water over the frozen area to melt the ice. Wipe away the water immediately to prevent it from freezing.
- To ensure proper operation of the climate control system fan, remove any snow that has accumulated on the air inlet vents in front of the windshield.
- Remove any ice that has accumulated on the vehicle chassis.
- Periodically check for and remove any excess ice or snow that may have accumulated in the wheel well or on the brakes.



### ■ When driving the vehicle

Accelerate the vehicle slowly and drive at a reduced speed suitable to road conditions.

### ■ When parking the vehicle

Park the vehicle and move the shift lever to P (automatic transmission) or R (manual transmission) without setting the parking brake. The parking brake may freeze up, preventing it from being released.

## Selecting tire chains

Use the correct tire chain size when mounting the snow chains. Chain size is regulated for each tire size.

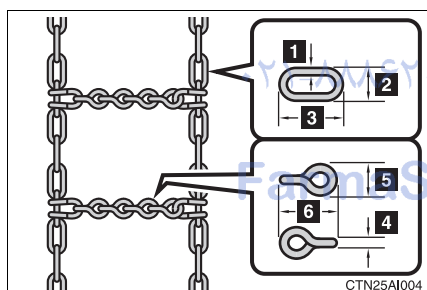

Side chain:

- 1 0.12 in. (3 mm) in diameter
- 2 0.39 in. (10 mm) in width
- 3 1.18 in. (30 mm) in length

Cross chain:

- 4 0.16 in. (4 mm) in diameter
- 5 0.55 in. (14 mm) in width
- 6 0.98 in. (25 mm) in length

## Regulations on the use of snow chains

- Regulations regarding the use of tire chains vary according to location and type of road. Always check local regulations before installing chains.
- Install the chains on the front tires.
- Retighten the chains after driving 1/4 - 1/2 mile (0.5 - 1.0 km).

### ■ Tire chains

Observe the following precautions when installing and removing chains.

- Install and remove tire chains in a safe location.
- Install tire chains on the front tires only. Do not install tire chains on rear tires.
- Install tire chains following the instructions provided in the accompanying manual.

### ⚠ CAUTION

#### ■ Driving with snow tires

Observe the following precautions to reduce the risk of accidents.

Failing to do so may result in a loss of vehicle control and cause death or serious injury.

- Use tires of the size specified for your vehicle.
- Maintain the recommended level of air pressure.
- Do not drive in excess of 75 mph (120 km/h), regardless of the type of snow tires being used.
- Use snow tires on all, not just some wheels.

#### ■ Driving with tire chains

Observe the following precautions to reduce the risk of accidents.

Failing to do so may result in the vehicle being unable to be driven safely, and may cause death or serious injury.

- Do not drive in excess of the speed limit specified for the tire chains being used or 30 mph (50 km/h), whichever is lower.
- Avoid driving on bumpy road surfaces or over potholes.
- Avoid sudden turns and braking, as use of chains may adversely affect vehicle handling.
- Slow down sufficiently before entering a curve to ensure that vehicle control is maintained.

 NOTICE

■ **Repairing or replacing snow tires**

Request repairs of and obtain replacement snow tires from Toyota dealers or legitimate tire retailers.

This is because the removal and attachment of snow tires affects the operation of the tire pressure warning valves and transmitters.

■ **Fitting tire chains**

The tire pressure warning valves and transmitters may not function correctly when tire chains are fitted.

امداد خودرو فارما

تلفن شبانه روزی: ۰۲۱-۸۸۶۲۰۸۵

FarmaSOS.com

# Trailer towing

Your vehicle is designed primarily as a passenger carrying vehicle. Towing a trailer will have an adverse effect on handling, performance, braking, durability, and fuel consumption. For your safety and the safety of others, do not overload the vehicle or trailer.

Toyota warranties do not apply to damage or malfunction caused by towing a trailer for commercial purposes.

### ■ Weight limits

Confirm that the total trailer weight, gross vehicle weight, gross axle weight and trailer tongue load are all within the limits.

### ■ Gross vehicle weight

The gross vehicle weight must not exceed the Gross Vehicle Weight Rating (GVWR) indicated on the Certification Label. The gross vehicle weight is the sum weight of the unloaded vehicle, driver, passengers, luggage, hitch and trailer tongue load. Also included is the weight of any special equipment installed on your vehicle.

### ■ Gross axle weight

The load on either the front or rear axle resulting from distribution of the gross vehicle weight on both axles must not exceed the Gross Axle Weight Rating (GAWR) listed on the Certification Label.

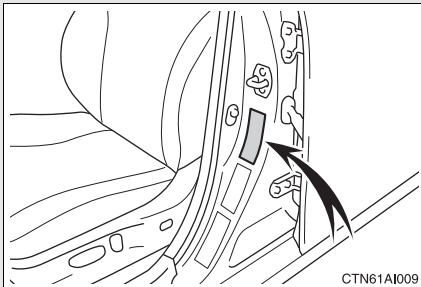

Certification label

### ■ Trailer tongue load

The trailer cargo load should be distributed so that the tongue load is 9 to 11% of the total trailer weight, not exceeding the maximum 100 lb. (45 kg). (Tongue load / Total trailer weight x 100 = 9 to 11%)

The total trailer weight and tongue load can be measured with platform scales found at highway weighing stations, building supply companies, trucking companies, junk yards, etc.

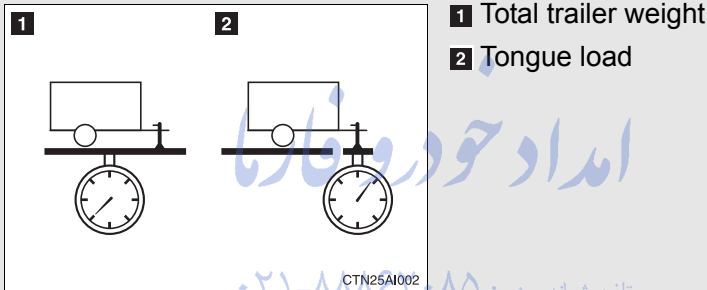

### Towing a trailer

Contact your Toyota dealer for further information about additional requirements such as a towing kits, etc.

### Hitch

Trailer hitch assemblies have different weight capacities established by the hitch manufacturer. Even though the vehicle may be rated for towing a higher weight, the operator must never exceed the maximum weight rating specified for the trailer hitch.

### ■ Before towing

- Ensure that your vehicle's tires are properly inflated. (→P. 392)
- Trailer tires should be inflated according to the trailer manufacturer's recommendation.
- All trailer lights must work in order to be legal.
- Confirm all lights work each time you connect them.
- Check that your vehicle remains level when a loaded or unloaded trailer is hitched. Do not drive if the vehicle is not level, and check for improper tongue load, overloading, worn suspension, or other possible causes.
- Make sure the trailer cargo is securely loaded.
- Check that your rear view mirrors conform to any federal, state/provincial or local regulations. If they do not, install rear view mirrors appropriate for towing purposes.

### ■ Break-in schedule

Toyota recommends that you do not use a new vehicle or a vehicle with any new power train components (engine, transmission, differential, wheel bearings, etc.) to tow a trailer for the first 500 miles (800 km) of driving.

### ■ Maintenance

- If you tow a trailer, your vehicle will require more frequent maintenance due to the additional load. (See "Scheduled Maintenance Guide" or "Owner's Manual Supplement".)
- Retighten the fixing bolts of the towing ball and bracket after approximately 600 miles (1000 km) of trailer towing.

 CAUTION

■ **To avoid accident or injury**

- The total trailer weight (trailer weight plus the weight of cargo) must not exceed 1000 lb. (453 kg).
- Do not exceed the trailer hitch assembly weight, gross vehicle weight, gross axle weight and trailer tongue load capacities.
- Never load more weight in the back than in the front of the trailer. About 60% of the load should be in the front half of the trailer, and the remaining 40% in the rear.

■ **Hitches**

- If you wish to install a trailer hitch, contact your Toyota dealer.
- Use only a hitch that conforms to the total trailer weight requirement.
- Follow the directions supplied by the hitch manufacturer.
- Lubricate the hitch ball with a light coat of grease.
- Remove the trailer hitch whenever you are not towing a trailer. After removing the hitch, seal any mounting hole in the vehicle body to prevent entry of any substances into the vehicle.

■ **When towing a trailer**

- Never tap into your vehicle's hydraulic system, as this will lower the vehicle's braking effectiveness.
- Never tow a trailer without using a safety chain securely attached to both the trailer and the vehicle. If damage occurs to the coupling unit or hitch ball, there is danger of the trailer wandering into another lane.

 NOTICE

■ **When installing a trailer hitch**

- Use only the position recommended by your Toyota dealer. Do not install the trailer hitch on the bumper; this may cause body damage.
- Do not use axle-mounted hitches, as they can cause damage to the axle housing, wheel bearings, wheels or tires.

■ **Brakes**

Toyota recommends trailers with brakes that conform to all applicable federal and state/provincial regulations.

■ **Safety chain**

A safety chain must always be used between the towing vehicle and the trailer. Leave sufficient slack in the chain for turns. The chain should cross under the trailer tongue to prevent the tongue from dropping to the ground in the case that it becomes damaged or separated. For the correct safety chain installation procedure, ask your Toyota dealer.

■ **Do not directly splice trailer lights**

Directly splicing trailer lights may damage your vehicle's electrical system and cause a malfunction.

### Trailer towing tips

Your vehicle will handle differently when towing a trailer. The 3 main causes of vehicle-trailer accidents are driver error, excessive speed and improper trailer loading. Keep the following in mind when towing.

- Before starting out, check the trailer lights and the vehicle-trailer connections. Recheck after driving a short distance.
- Practice turning, stopping and reversing with the trailer attached in an area away from traffic until you become accustomed to the feel of the vehicle.



- Reversing with a trailer attached is difficult and requires practice. Grip the bottom of the steering wheel and move your hand to the left to move the trailer to the left. Move your hand to the right to move the trailer to right. (This is generally opposite to reversing without a trailer attached.) Avoid sharp or prolonged turning. Have someone guide you when reversing to reduce the risk of an accident.
- As stopping distance is increased when towing a trailer, vehicle-to-vehicle distance should be increased. For each 10 mph (16 km/h) of speed, allow at least one vehicle and trailer length.
- Avoid sudden braking as you may skid, resulting in jackknifing and loss of control. This is especially true on wet or slippery surfaces.
- Avoid jerky starts or sudden acceleration.
- Avoid jerky steering and sharp turns, and slow down before making turns.
- Note that when making a turn, the trailer wheels will be closer than the vehicle wheels to the inside of the turn. Compensate by making a larger than normal turning radius.
- Crosswinds and rough roads will adversely affect handling of your vehicle and trailer, causing sway. Periodically check the rear to prepare for being passed by large trucks or buses, which may cause your vehicle and trailer to sway. If swaying occurs, firmly grip the steering wheel, reduce speed immediately but gradually, and steer straight ahead. Never increase speed. If you make no extreme correction with the steering or brakes, your vehicle and trailer will stabilize.
- Take care when passing other vehicles. Passing requires considerable distance. After passing a vehicle, do not forget the length of your trailer, and be sure you have plenty of room before changing lanes.

- In order to maintain efficient engine braking and electrical charging performance, do not use overdrive (automatic transmission) or the 5th gear (manual transmission).
- Due to the added load of the trailer, your vehicle's engine may overheat on hot days (at temperatures over 85°F [30°C]) when driving up a long or steep grade. If the engine coolant temperature gauge indicates overheating, immediately turn off the air conditioning (if in use), pull your vehicle off the road and stop in a safe spot. (→P. 475)
- Always place wheel blocks under both the vehicle and the trailer wheels when parking. Apply the parking brake firmly, and put the transmission in P (automatic transmission) or in first or R (manual transmission). Avoid parking on a slope, but if unavoidable, do so only after performing the following:

**STEP 1** Apply the brakes and keep them applied.

**STEP 2** Have someone place wheel blocks under both the vehicle and trailer wheels.

**STEP 3** When the wheel blocks are in place, release the brakes slowly until the blocks absorb the load.

**STEP 4** Apply the parking brake firmly.

**STEP 5** Shift into first or R (manual transmission) or P (automatic transmission) and turn off the engine.

- When restarting after parking on a slope:

**STEP 1** With the transmission in the P position (automatic transmission) or the clutch pedal (manual transmission) depressed, start the engine. On vehicles with an automatic transmission, be sure to keep the brake pedal pressed.

**STEP 2** Shift into a forward gear. If reversing, shift into the R position.

**STEP 3** Release the parking brake (also brake pedal on vehicles with automatic transmission), and slowly pull or back away from the wheel blocks. Stop and apply the brakes.

**STEP 4** Have someone retrieve the blocks.

 CAUTION

■ **To avoid an accident**

- Do not exceed 45 mph (72 km/h) or posted towing speed limit, whichever is lower. As instability (swaying) of the towing vehicle-trailer combination increases as speed increases, exceeding 45 mph (72 km/h) may cause loss of control.
- Slow down and downshift before descending steep or long downhill grades. Do not make sudden downshifts.
- Avoid holding the brake pedal down too long or applying the brakes too frequently. This could cause the brakes to overheat and result in reduced braking efficiency.

امداد خودرو فارما

تلفن شبانه روزی: ۰۲۱-۸۸۸۶۲۰۸۵

FarmaSOS.com

## 2-5. Driving information

### Dinghy towing (automatic transmission)

Your vehicle is not designed to be dinghy towed (with 4 wheels on the ground) behind a motor home.

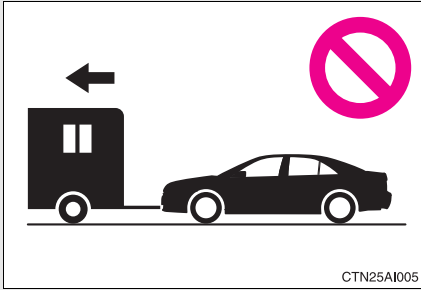

NOTICE

■ To avoid serious damage to your vehicle

Do not tow your vehicle with four wheels on the ground.

تلفن شبانه روزی: ۰۲۱-۸۸۸۶۲۰۸۵

FarmaSOS.com

## 2-5. Driving information

### Dinghy towing (manual transmission)

Your vehicle can be dinghy towed in a forward direction (with 4 wheels on the ground) behind a motor home.

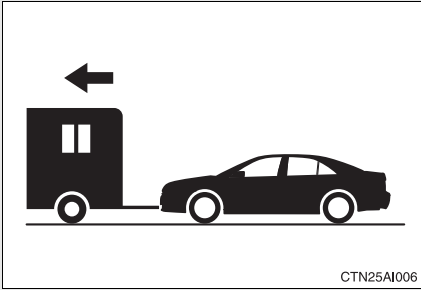

#### Towing your vehicle with 4 wheels on the ground

To prevent damage to your vehicle, perform the following procedures before towing.

**STEP 1** Shift the shift lever to neutral. تلفن شبانه روزی: ۰۵۱۶۳۸۱۶۳۸

**STEP 2** Switch to the "ACC" position. (→P. 135)

Ensure that the audio system and other powered devices have been turned off. FarmaSOS.com

**STEP 3** Release the parking brake.

After towing, run the engine in idle for at least 3 minutes before driving the vehicle.

#### ■ Necessary equipment and accessories

Specialized equipment and accessories are required for dinghy towing. Contact the service branch of the motor home manufacturer regarding recommended equipment.

 NOTICE

■ **Dinghy towing direction**

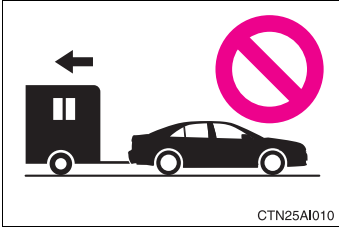

Do not tow the vehicle backwards.  
Doing so may cause serious damage.

■ **To prevent the steering from locking**

Ensure the engine switch is in the "ACC" position.

تلفن شبانه روزی: ۰۲۱-۸۸۶۲۰۸۵

FarmaSOS.com

### 3-1. Using the air conditioning system and defogger Automatic air conditioning system\*

Air outlets are automatically selected and fan speed is automatically adjusted according to the temperature setting.

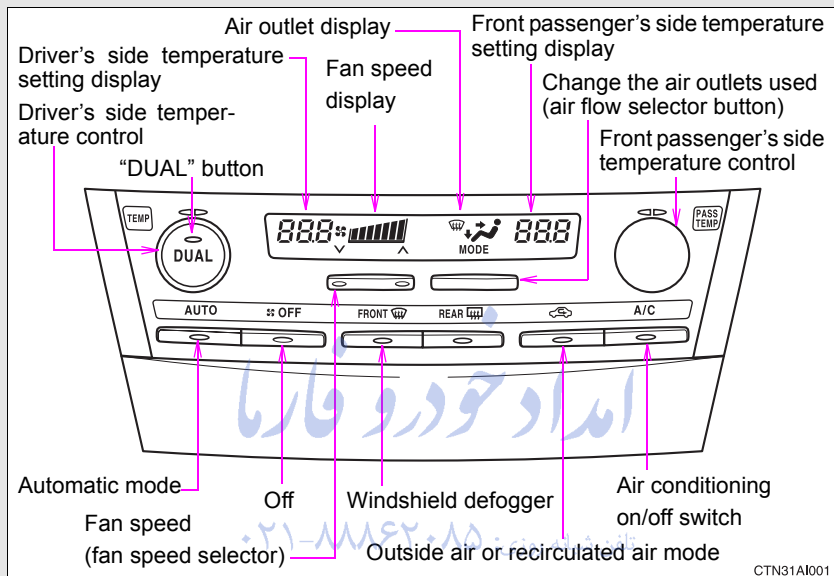

CTN31AI001

FarmaSOS.com

\*: If equipped

## Using the automatic mode

**STEP 1** Press .

The air conditioning system will begin to operate. Air outlets and fan speed are automatically adjusted according to the temperature setting.



**STEP 2** Turning  to the right increases the temperature and



turning  to the left decreases the temperature on the driver's side.

The temperature for the driver and passenger seats can be set separately. (→P. 197)

## Adjusting the settings

### ■ Adjusting the temperature setting تلفن شبانه روز

Turning  to the right increases the temperature and turning  to the left decreases the temperature on the driver's side.

Turn  to the right (increase) or  to the left (decrease) on the passenger's side to separately adjust the temperature for the passenger's and driver's side (dual mode). Press  to return the driver's and passenger's side temperatures to the same setting (simultaneous mode).

The air conditioning system switches between dual and simultaneous mode each time  is pressed.



### ■ Adjusting the fan speed

Press “^” (increase) or “v” (decrease) on the fan speed selector.

The fan speed is shown on the display. (7 levels)

Press  to turn the fan off.

### ■ Changing the air outlets

Press the air flow selector button.

The air outlets switch each time the button is pressed. The air flow shown on the display indicates the following.

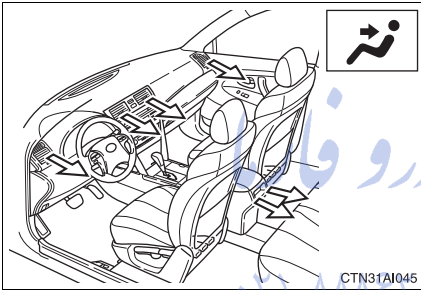

Air flows to the upper body.

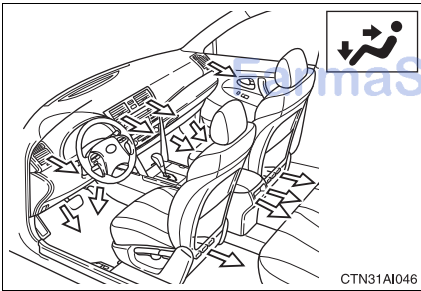

Air flows to the upper body and feet.

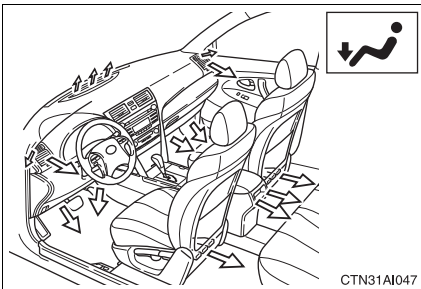

Air flows to the feet.

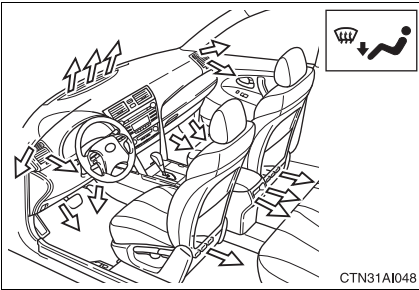

Air flows to the feet and the windshield defogger operates.

Recirculated air mode will automatically switch to outside air mode.

■ **Switching between outside air and recirculated air modes**

Press  .

The mode switches between outside air mode (indicator off) and recirculated air mode (indicator on) modes each time  is pressed.

**Defogging the windshield**

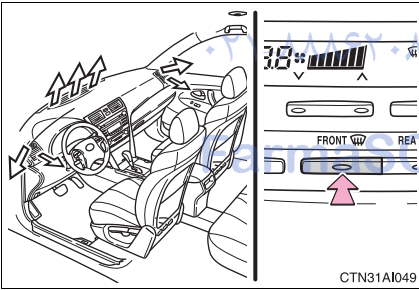

**Defogging**

The air conditioning system control operates automatically.

Recirculated air mode will automatically switch to outside air mode. It is not possible to return to recirculated air mode when the switch is on.

### Adjusting the position of and opening and closing the air outlets

#### ► Center outlets

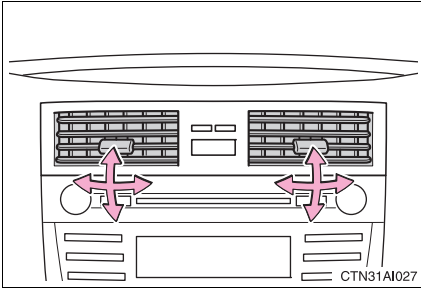

Direct air flow to the left or right, up or down.

#### ► Right and left side outlets

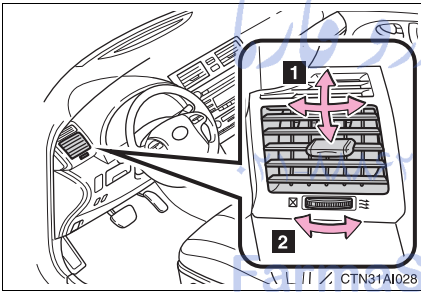

**1** Direct air flow to the left or right, up or down.

**2** Turn the knob right to open the vent and left to close the vent.

تلفن شبانه روزی: ۸۵

#### ► Rear outlets

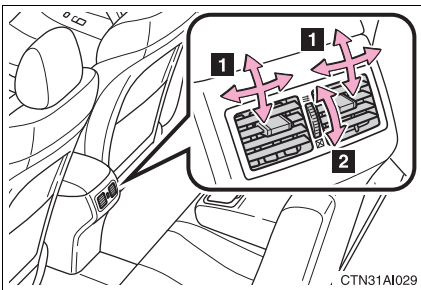

**1** Direct air flow to the left or right, up or down.

**2** Turn the knob up to open the vent and down to close the vent.

### Steering wheel switches (if equipped)

Some air conditioning features can be controlled using the switches on the steering wheel.

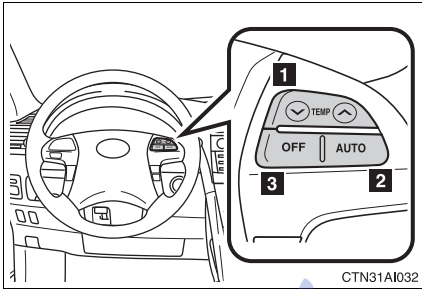

#### 1 Temperature selector

“DUAL” button indicator on: Individual setting on the driver's side only.

“DUAL” button indicator off: Simultaneous setting on the driver's and front passenger's sides.

#### 2 Automatic mode

#### 3 Off

### ■ Using the automatic mode

**STEP 1** Press .

The air conditioning system will begin to operate. Air outlets and fan speed are automatically adjusted according to the temperature setting. (→P. 196)

**STEP 2** Press “^” to increase the temperature and “v” to decrease the temperature on .

The temperature for the driver and passenger seat can be set separately. (→P. 197)

### ■ Adjusting the temperature setting

Press “^” to increase the temperature and “v” to decrease the temperature on .

### ■ Turning off the air conditioning system

Press .

### ■ Using the automatic mode

Fan speed is adjusted automatically in accordance with the temperature setting and ambient conditions. As a result, the following may occur.

- Immediately after  is pressed, the fan may stop for a while until warm or cool air is ready to flow.
- Cool air may flow to the area around the upper body when the heater is on.

### ■ Using the system in recirculated air mode

The windows will fog up more easily if the recirculated air mode is used for an extended period.

### ■ Switching between outside air and recirculated air modes

Recirculated air mode or outside air mode may be automatically switched to in accordance with the temperature setting and the inside temperature.

### ■ Window defogger feature

Recirculated air mode may automatically switch to outside air mode in situations where the windows need to be defogged.

### ■ When outside air temperature approaches 32°F (0°C)

The air conditioning system may not operate even when  is pressed.

### ■ When the indicator light on flashes

Press  and turn off the air conditioning system before turning it on once more. There may be a problem in the air conditioning system if the indicator light continues to flash. Turn the air conditioning system off and have it inspected by your Toyota dealer.

### ■ Windshield air flow button

When any of the following conditions occurs, the indicator light on the button may flash and a motor sound may be heard. This does not indicate a malfunction.

- The “ENGINE START STOP” switch is in ON mode (vehicles with smart key system) or the engine switch is in the “ON” position (vehicles without smart key system) after the battery is reconnected.
- Engine starting and stopping is repeated at short intervals.
- The engine is started with the low voltage battery.

### ■ Plasmacluster™\*

This air conditioning system adopts plasmacluster technology, which helps to keep good air quality in the cabin by emitting positive and negative ions through the driver's side vent.

A slight noise may be heard during operation. This is not a malfunction.

Also, static electricity may be discharged near the driver's side vent due to the high voltage used to operate the system.

To clean the driver's side vent, turn the system off and wipe the vent using a soft cloth.

\*: Plasmacluster technology is manufactured under license from SHARP Corporation. "Plasmacluster™" is a trademark of the SHARP Corporation.

### ■ Air conditioning odors

- During use, various odors from inside and outside the vehicle may enter into and accumulate in the air conditioning system. This may then cause odor to be emitted from the vents.
- To reduce potential odors from occurring:
  - It is recommended that the air conditioning system be set to outside air mode prior to turning the vehicle off.
  - The start timing of the blower may be delayed for a short period of time immediately after the air conditioning system is started in automatic mode.

FarmaSOS.com

### ⚠ CAUTION

#### ■ To prevent the windshield from fogging up

Do not use  during cool air operation in extremely humid weather. The difference between the temperature of the outside air and that of the windshield can cause the outer surface of the windshield to fog up, blocking your vision.

#### ■ Plasmacluster™

Do not disassemble or repair the system because it contains high voltage parts. Call your Toyota dealer if the system needs repair.

 NOTICE

■ **To prevent battery discharge**

Do not leave the automatic air conditioning system on longer than necessary when the engine is stopped.

■ **To prevent damage to the Plasmacluster™**

Do not insert anything into the driver's side vent, attach anything to it, or use sprays around the driver's side vent. These things may cause the system not to work properly.

امداد خودرو فارما

تلفن شبانه روزی: ۰۲۱-۸۸۸۶۲۰۸۵

FarmaSOS.com

### 3-1. Using the air conditioning system and defogger Manual air conditioning system\*

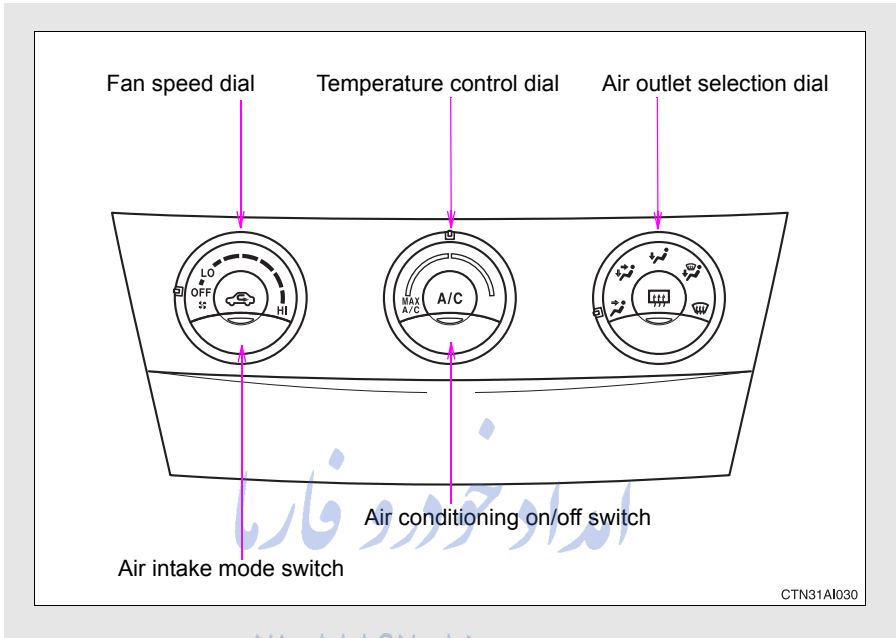

تلفن شبانه روزی: ۰۲۱-۸۸۶۲۰۸۵

#### Adjusting the settings

##### ■ Adjusting the temperature setting

Turn the temperature control dial clockwise (warm) or counter-clockwise (cool).

If  is not pressed, the system will blow ambient temperature air or heated air.

For quick cooling, turn the temperature selector knob to the “MAX A/C” position. The air conditioning will automatically turn on and the air intake selector will be set to RECIRCULATE.

\*: If equipped



### ■ Adjusting the fan speed

Turn the fan speed dial clockwise (increase) or counterclockwise (decrease).

Set the dial to "OFF" to turn the fan off.

### ■ Selecting the air outlets

Set the air outlet selection dial to an appropriate position.

The positions between the air outlet selections shown below can also be selected for more detailed adjustment.

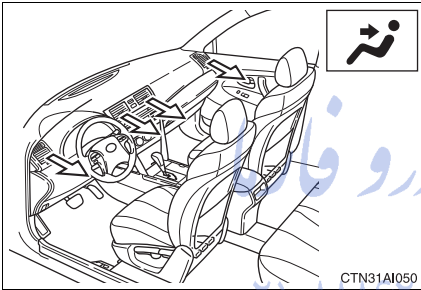

Air flows to the upper body.

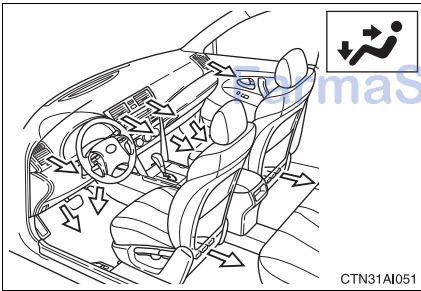

Air flows to the upper body and feet.

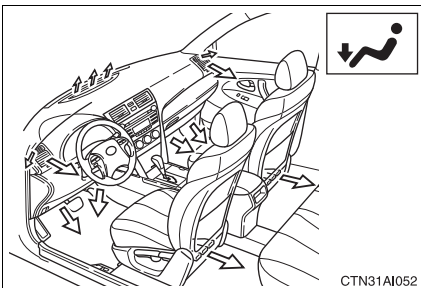

Air flows to the feet.

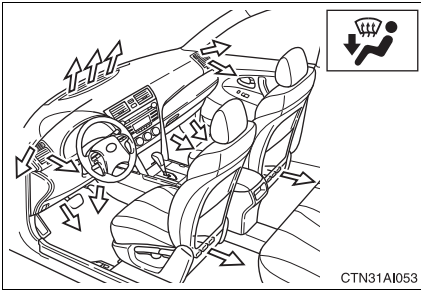

Air flows to the feet and the windshield defogger operates.

The air intake is automatically switched to outside air mode.

Pressing  to turn the air conditioning on clears the windshield and side windows faster.

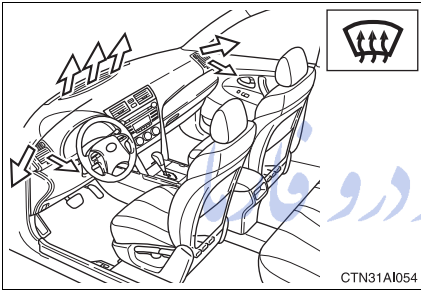

Air flows to the windshield and side windows.

The air intake is automatically switched to outside air mode. It is not possible to return to recirculated air mode when the switch is on.

Pressing  to turn the air conditioning on clears the windshield and side windows faster.

### ■ Switching between outside air and recirculated air modes

Press  .

The mode switches between outside air mode (indicator off) and recirculated air mode (indicator on) modes each time  is pressed.

تلفن شماره روزی: ۰۲۱-۸۸۶۲۰۸۵

Forman66.com

## Adjusting the position of and opening and closing the air outlets

### ► Center outlets

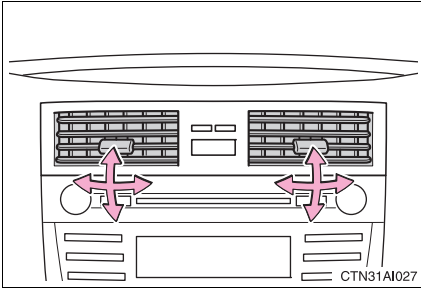

Direct air flow to the left or right, up or down.

### ► Right and left side outlets

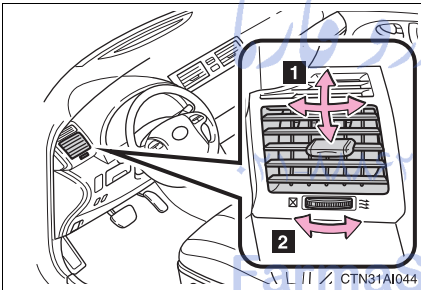

1 Direct air flow to the left or right, up or down.

2 Turn the knob right to open the vent and left to close the vent.

تلفن شبانه روزی: ۸۵

OS.com

## ■ Using the system in recirculated air mode

The windows will fog up more easily if the recirculated air mode is used for an extended period.

## ■ Window defogger feature

### ► Vehicles with smart key system

In order to prevent the windows from fogging up, recirculated air mode may automatically switch to outside air mode if the ambient temperature drops. This feature can be cancelled by pushing and holding the air intake mode switch for longer than 2 seconds. The feature will be reactivated when the "ENGINE START STOP" switch is turned to ACCESSORY or IGNITION ON mode.

► Vehicles without smart key system

In order to prevent the windows from fogging up, recirculated air mode may automatically switch to outside air mode if the ambient temperature drops. This feature can be cancelled by pushing and holding the air intake mode switch for longer than 2 seconds. The feature will be reactivated when the engine switch is turned to the “ACC” or “LOCK” position.

■ **When outside air temperature approaches 32°F (0°C)**

The air conditioning system may not operate even when  is pressed.

■ **When the indicator light on  flashes**

Press  and turn off the air conditioning system before turning it on once more. There may be a problem in the air conditioning system if the indicator light continues to flash. Turn the air conditioning system off and have it inspected by your Toyota dealer.

■ **Air conditioning odors**

- During use, various odors from inside and outside the vehicle may enter into and accumulate in the air conditioning system. This may then cause odor to be emitted from the vents.
- To reduce potential odors from occurring:  
It is recommended that the air conditioning system be set to outside air mode prior to turning the vehicle off.

 **CAUTION**

■ **To prevent the windshield from fogging up**

Do not set the air outlet selection dial to  during cool air operation in extremely humid weather. The difference between the temperature of the outside air and that of the windshield can cause the outer surface of the windshield to fog up, blocking your vision.

 NOTICE

■ **To prevent battery discharge**

Do not leave the air conditioning system on longer than necessary when the engine is stopped.

امداد خودرو فارما

تلفن شبانه روزی: ۰۲۱-۸۸۸۶۲۰۸۵

FarmaSOS.com

### 3-1. Using the air conditioning system and defogger Rear window and outside rear view mirror defoggers

#### Clear the rear window using the defogger.

##### ► Vehicles with automatic air conditioning system

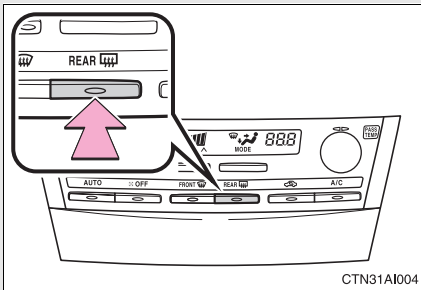

##### On/off

The defoggers will automatically turn off the operation time. The operation time is between 15 minutes and 1 hour depending on the ambient temperature and vehicle speed.

##### ► Vehicles with manual air conditioning system

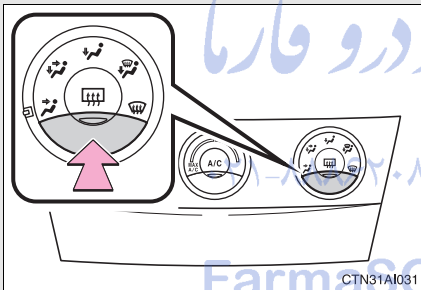

##### On/off

The defoggers will automatically turn off the operation time. The operation time is between 15 minutes and 1 hour depending on the ambient temperature and vehicle speed.

#### ■ Outside rear view mirror defoggers (if equipped)

Turning the rear window defogger on will turn the outside rear view mirror defoggers on.

#### ■ When the indicator light on the switch flashes and a motor sound is heard (vehicles with manual air conditioning)

If any of the following conditions occurs, it does not indicate a malfunction.

- The “ENGINE START STOP” switch is in IGNITION ON mode (vehicles with smart key system) or the engine switch is in the “ON” position (vehicles without smart key system) after the battery is reconnected.
- Engine starting and stopping is repeated at short intervals.
- The engine is started with the low voltage battery.

 CAUTION

■ **Outside rear view mirror defoggers (if equipped)**

The surfaces of the outside rear view mirrors become hot. Do not touch them to prevent from burning yourself.

امداد خودرو فارما

تلفن شبانه روزی: ۰۲۱-۸۸۸۶۲۰۸۵

FarmaSOS.com

## 3-2. Using the audio system

### Audio system types

#### ► With navigation system

Owners of models equipped with a navigation system should refer to the “Navigation System Owner’s Manual”.

#### ► Without navigation system

Type A: CD player with changer controller and AM/FM radio

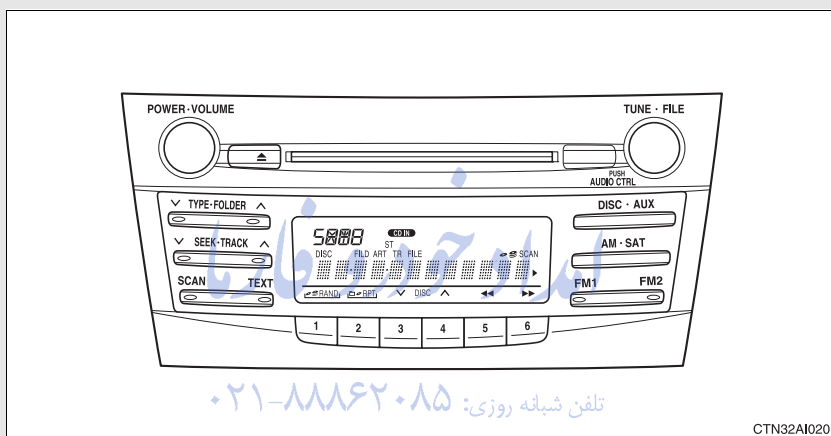

Type B: CD player with changer and AM/FM radio

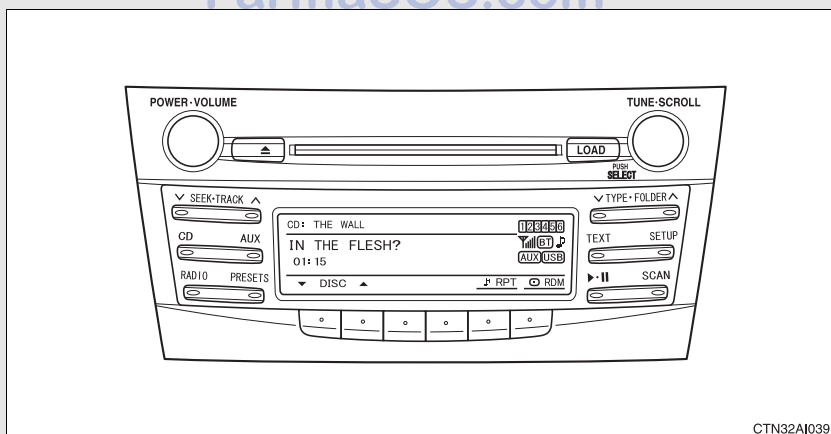



Type C: CD player with changer controller and AM/FM radio

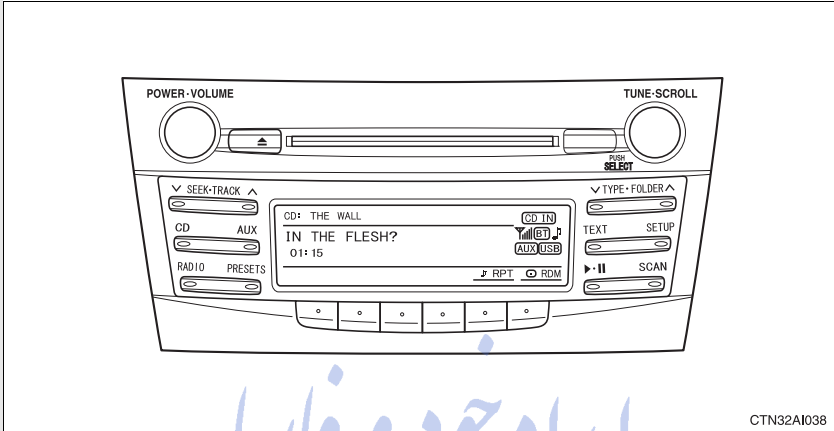

CTN32AI038

Title	Page
Using the radio	P. 215
Using the CD player	P. 223
Playing MP3 and WMA discs	P. 232
Operating an iPod® player	P. 240
Operating a USB memory player	P. 246
Optimal use of the audio system	P. 253
Using the AUX adapter	P. 258
Using the steering wheel audio switches	P. 260

## Language settings (type B and C)

The language used for all voice guidance, voice recognition and messages may be changed.

**STEP 1** Press  .

**STEP 2** Press  that corresponds to "MORE".

**STEP 3** Press  that corresponds to "LANG".

**STEP 4** Press  that corresponds to the desired language.

► For vehicles sold in the U.S.A.

"ENG" (English) or "ESP" (Spanish)

► For vehicles sold in Canada

"ENG" (English) or "FRAN" (French)

### ■ Using cellular phones

Interference may be heard through the audio system's speakers if a cellular phone is being used inside or close to the vehicle while the audio system is operating.

 CAUTION

■ **For vehicles sold in U.S.A. and Canada**

● Part 15 of the FCC Rules

FCC Warning:

Any unauthorized changes or modifications to this equipment will void the user's authority to operate this device.

● Laser products

- Do not take this unit apart or attempt to make any changes yourself.

This is an intricate unit that uses a laser pickup to retrieve information from the surface of compact discs. The laser is carefully shielded so that its rays remain inside the cabinet. Therefore, never try to disassemble the player or alter any of its parts since you may be exposed to laser rays and dangerous voltages.

- This product utilizes a laser.

Use of controls or adjustments or performance of procedures other than those specified herein may result in hazardous radiation exposure.

 NOTICE

■ **To prevent battery discharge**

Do not leave the audio system on longer than necessary with the engine off.

■ **To avoid damaging the audio system**

Take care not to spill drinks or other fluids over the audio system.

## 3-2. Using the audio system

### Using the radio

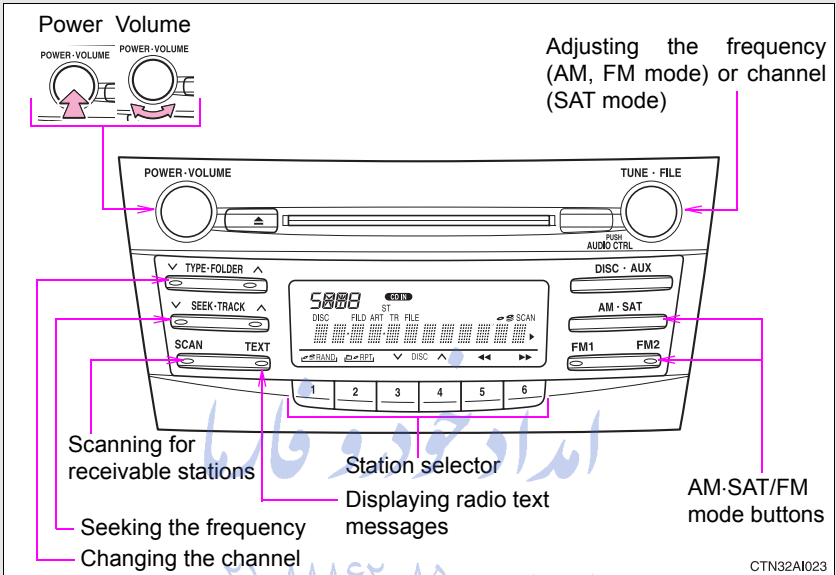

#### ► Type A



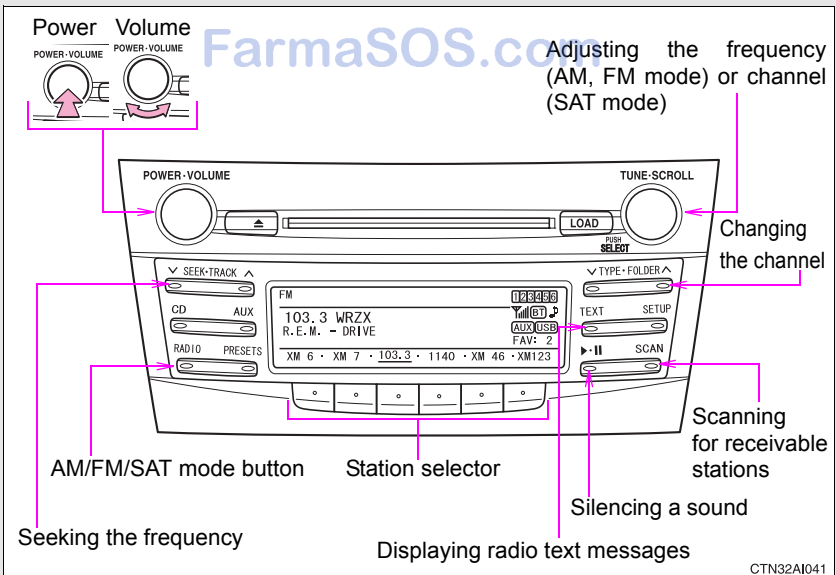

#### ► Type B and C



## Setting station presets (excluding XM<sup>®</sup> Satellite Radio)



**STEP 1** Search for desired stations by turning  or  or pressing “^” or “v” on .



**STEP 2** Press and hold a button (from  to  or one of ) until you hear a beep.

Type B and C: Each time  is pressed, station pages are changed. There are a total of 6 pages.

## Scanning radio stations (excluding XM<sup>®</sup> Satellite Radio)

### ■ Scanning the preset radio stations



**STEP 1** Press and hold  or  until you hear a beep.  
Preset stations will be played for 5 seconds each.

**STEP 2** When the desired station is reached, press  or  again.

### ■ Scanning all radio stations within range

**STEP 1** Press  or .

All the stations with reception will be played for 5 seconds each.

**STEP 2** When the desired station is reached, press  or  again.

### ■ Displaying radio text messages (for type B and C, FM mode only)

When a new radio text message is received, “MSG” is shown on the display. To display the message, press .



If the text continues past the end of the display, “▶” is displayed. Press and hold  until you hear a beep.

Text messages are not displayed while driving.

## XM<sup>®</sup> Satellite Radio (if equipped)



### ■ Receiving XM<sup>®</sup> Satellite Radio

**STEP 1** Press  or .

The display changes as follows each time  or  is pressed.



Type A: AM → SAT1 → SAT2 → SAT3

Type B and C: AM → FM → SAT

**STEP 2** Turn  or  to select the desired channel in all the



categories or press “^” or “v” on  to select the desired channel in the current category.

### ■ Setting XM<sup>®</sup> Satellite Radio channel presets

Select the desired channel. Press and hold a button (from  to  or one of  ) until you hear a beep.

Type B and C: Each time  is pressed, station pages are changed. There are a total of 6 pages.

### ■ Changing the channel category

Press “^” or “v” on  or .

### ■ Scanning XM<sup>®</sup> Satellite Radio channels



#### ● Scanning channels in the current category

**STEP 1** Press  or .

**STEP 2** When the desired channel is reached, press  or

 again.

#### ● Scanning the preset channels

**STEP 1** Press and hold  or  until you hear a beep.

**STEP 2** When the desired channel is reached, press  or

 again.

## ■ Displaying text information

Press  or .

Type A: Each time  is pressed, the display changes in the following order:

Channel name → Title (song/program title) → Name (artist name/feature)  
→ Channel number.

Type B and C: Each time  is pressed, the display changes in the following order:

Title (song/program title) → Title (song/program title)/Name (artist name/feature).

تلفن شبانه روزی: ۰۲۱-۸۸۶۲۰۸۵

FarmaSOS.com



■ **When the battery is disconnected**

All preset stations are erased. (type A only)

■ **Reception sensitivity**

- Maintaining perfect radio reception at all times is difficult due to the continually changing position of the antenna, differences in signal strength and surrounding objects, such as trains, transmitters, etc.
- The radio antenna is mounted inside the rear window. To maintain clear radio reception, do not attach metallic window tinting or other metallic objects to the antenna wire mounted inside the rear window.

■ **XM<sup>®</sup> Satellite Radio**

An XM<sup>®</sup> Satellite Radio is a tuner designed exclusively to receive broadcasts provided under a separate subscription. Availability is limited to the 48 contiguous states and 10 Canadian provinces.

● XM<sup>®</sup> subscriptions

For detailed information about XM<sup>®</sup> Satellite Radio or to subscribe:  
U.S.A. —

Visit on the web at [www.xmradio.com](http://www.xmradio.com) or call 1-800-967-2346.

Canada —

Visit on the web at [www.xmradio.ca](http://www.xmradio.ca) or call 1-877-438-9677.

● Radio ID

You will need the radio ID when activating XM<sup>®</sup> service or reporting a

problem. Select "CH000" using

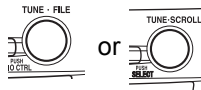

or

,

and the receiver's 8-

● Satellite tuner

The tuner supports only Audio Services (Music and Talk) and the accompanying Text Information of XM<sup>®</sup> Satellite Radio.

### ■ If XM<sup>®</sup> Satellite Radio does not operate normally

If a problem occurs with the XM<sup>®</sup> tuner, a message will appear on the display. Refer to the table below to identify the problem, and take the suggested corrective action.

ANTENNA or CHECK ANTENNA	The XM <sup>®</sup> antenna is not connected. Check whether the XM <sup>®</sup> antenna cable is attached securely.
	There is a short-circuit in the antenna or the surrounding antenna cable. See a Toyota certified dealer.
UPDATING	You have not subscribed to XM <sup>®</sup> Satellite Radio. The radio is being updated with the latest encryption code. Contact XM <sup>®</sup> Satellite Radio for subscription information. When a contract is canceled, you can choose the "CH000" and all free-to-air channels.
	The premium channel you selected is not authorized. Wait for about 2 seconds until the radio returns to the previous channel or "CH001". If it does not change automatically, select another channel. If you want to listen to the premium channel, contact XM <sup>®</sup> Satellite Radio.
NO SIGNAL	The XM <sup>®</sup> signal is too weak at the current location. Wait until your vehicle reaches a location with a stronger signal.
LOADING	The unit is acquiring audio or program information. Wait until the unit has received the information.
OFF AIR or CHANNEL OFF AIR	The channel you selected is not broadcasting any programming. Select another channel.
----	There is no song/program title or artist name/feature associated with the channel at this time. No action needed.

---

The channel you selected is no longer available. Wait for about 2 seconds until the radio returns to the previous channel or "CH001". If it does not change automatically, select another channel.

Contact the XM<sup>®</sup> Listener Care Center at 1-800-967-2346 (U.S.A.) or 1-877-438-9677 (Canada)

### ■ Certifications for the radio tuner

This equipment has been tested and found to comply with the limits for a class B digital device, pursuant to Part 15 of the FCC Rules. These limits are designed to provide reasonable protection against harmful interference in a residential installation. This equipment generates, uses and can radiate radio frequency energy and, if not installed and used in accordance with the instructions, may cause harmful interference to radio communications. However, there is no guarantee that interference will not occur in a particular installation.

If this equipment does cause harmful interference to radio or television reception, which can be determined by turning the equipment off and on, the user is encouraged to try to correct the interference by trying one or more of the following:

- Reorienting or relocating the receiving antenna.
- Increasing the separation between the equipment and receiver.
- Connecting the equipment into an outlet on a circuit different from that to which the receiver is connected.
- Consulting the dealer or an experienced radio/TV technician for help.

## 3-2. Using the audio system

### Using the CD player

#### ► Type A

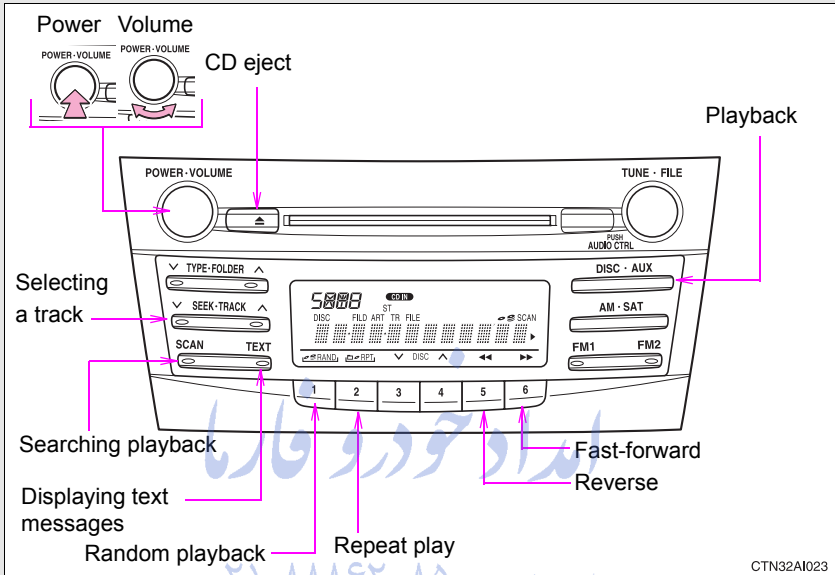

#### ► Type B and C

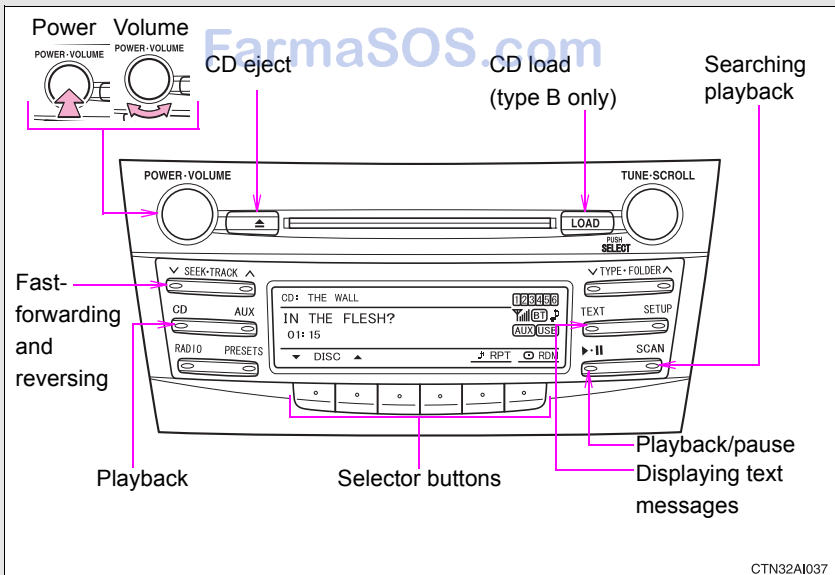

## Loading CDs

### ■ Loading a CD (type A and C)

Insert a CD.

### ■ Loading a CD (type B)

**STEP 1** Press  .

**STEP 2** When the indicator on the slot turns from amber to green, insert a CD.

### ■ Loading multiple CDs (type B only)

**STEP 1** Press and hold  until you hear a beep.

**STEP 2** When the indicator on the slot turns from amber to green, insert a CD.

The indicator on the slot turns to amber when the CD is inserted.

**STEP 3** When the indicator on the slot turns from amber to green again, insert the next CD.

Repeat the procedure for the remaining CDs.

To cancel, press  <sup>CD</sup>. If you do not insert a disc within 15 seconds, loading will be canceled automatically.

## Ejecting CDs

### ■ Ejecting a CD (type A and C)

Press  and remove the CD.

### ■ Ejecting a CD (type B)

**STEP 1** To select the CD to be ejected, press  that corresponds to “▲” or “▼”.

The selected CD number is shown on the display.

**STEP 2** Press  and remove the CD.



### ■ Ejecting all the CDs (type B only)

Press and hold  until you hear a beep, and then remove the CDs.

## Selecting a track

Press “^” to move up or “v” to move down using  until the desired track number is displayed.

## Fast-forwarding and reversing tracks

Type A: Press  (◀◀) or  (▶▶).



Type B and C: Press and hold “^” or “v” on  .

## Scanning tracks

**STEP 1** Press  or .

The first ten seconds of each track will be played.

To cancel, press  or  again.

**STEP 2** Press  or  again when the desired track is reached.

## Selecting a CD (type B only)

### ■ Selecting a CD to play

Press  that corresponds to “▲” or “▼”.

### ■ Scanning loaded CDs

**STEP 1** Press and hold  until you hear a beep.

The first ten seconds of the first track on each CD will be played.

To cancel, press  again.

**STEP 2** Press  again when the desired CD is reached.

## Playing and pausing tracks (type B and C)

Press .

## Random playback

### ■ Current CD

Press  (RAND) or  that corresponds to “RDM”.

Songs are played in random order.

To cancel, press the same button until “OFF” is displayed.

### ■ All CDs (type B only)

Press  that corresponds to “RDM” twice.

Tracks on all loaded CDs are played in random order.

To cancel, press the button again.

## Repeat play

### ■ Repeating a track

Press  (RPT) or  that corresponds to “RPT”.

To cancel, press the same button until “OFF” is displayed.

### ■ Repeating all of the tracks on a CD (type B only)

Press  that corresponds to “RPT” twice.

To cancel, press the button again.



## Switching the display

Press  or .

Type A: Each time  is pressed, the display changes in the following order:

Track no./Elapsed time → CD title → Track name.

Type B and C: Each time  is pressed, the display changes in the following order:

Track title → Track name/Artist name → Track name/Elapsed time.

### ■ Display (type A only)

Up to 12 characters can be displayed at a time.

If there are 13 characters or more, pressing and holding  for 1 second or more will display the remaining characters. A maximum of 24 characters can be displayed.



If  is pressed for 1 second or more again or has not been pressed for 6 seconds or more, the display will return to the first 12 characters.

Depending on the contents recorded, the characters may not be displayed properly or may not be displayed at all.

### ■ Error messages

“CD CHECK”: This indicates a problem either with the CD or inside the player. The CD may be dirty, damaged or inserted up-side down.

“WAIT” or “PLEASE WAIT”: Operation has stopped due to a high temperature inside the player. Wait for a while and then

press  or  . Contact your Toyota dealer if the CD still cannot be played back.

### ■ Discs that can be used

Discs with the marks shown below can be used.

Playback may not be possible depending on the recording format or disc features, or due to scratches, dirt or deterioration.



CDs with copy-protection features may not be used.

### ■ CD player protection feature

To protect the internal components, playback is automatically stopped when a problem is detected while the CD player is being used.

### ■ If CDs are left inside the CD player or in the ejected position for extended periods

CDs may be damaged and may not play properly.

### ■ Lens cleaners

Do not use lens cleaners. Doing so may damage the CD player.

 NOTICE

**■ CDs and adapters that cannot be used**

Do not use the following types of CDs, 3 in. (8 cm) CD adapters or Dual Discs.

Doing so may damage the CD player and/or the CD insert/eject function.

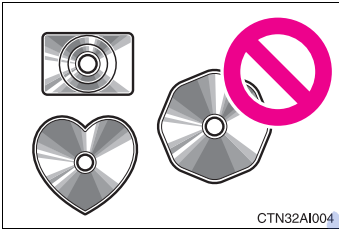

- CD player with changer and AM/FM radio: CDs that have a diameter that is not 4.7 in. (12 cm)

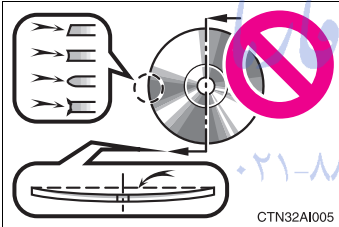

- Low-quality and deformed CDs

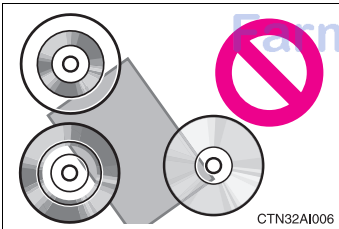

- CDs with a transparent or translucent recording area

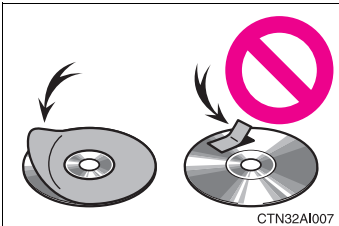

- CDs that have had tape, stickers or CD-R labels attached to them, or that have had the label peeled off

 NOTICE

**■ CD player precautions**

Failure to follow the precautions below may result in serious damage to the CDs or the player itself.

- Do not insert anything other than CDs into the CD slot.
- Do not apply oil to the CD player.
- Store CDs away from direct sunlight.
- Never try to disassemble any part of the CD player.

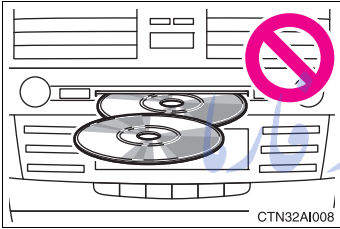

- Do not insert more than one CD at a time.

تلفن شبانه روزی: ۰۲۱-۸۸۶۲۰۸۵

FarmaSOS.com

## 3-2. Using the audio system Playing MP3 and WMA discs

### ► Type A

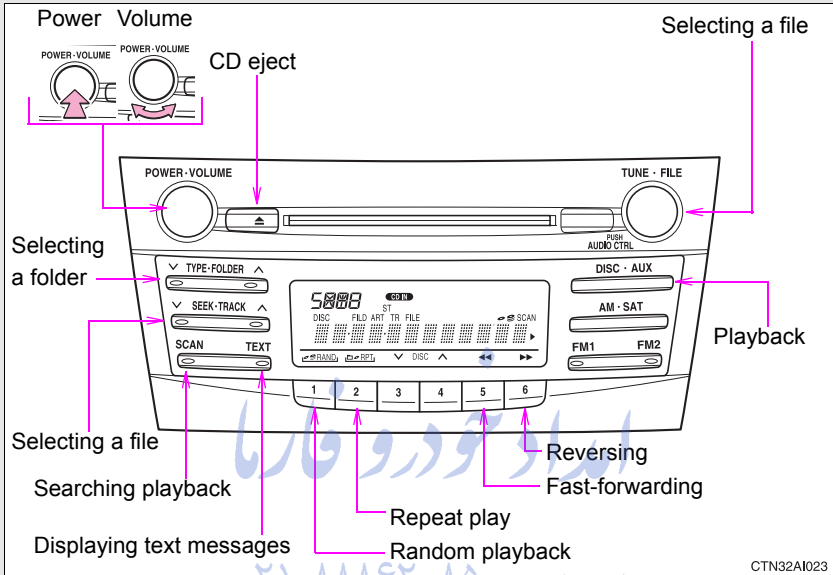

### ► Type B and C

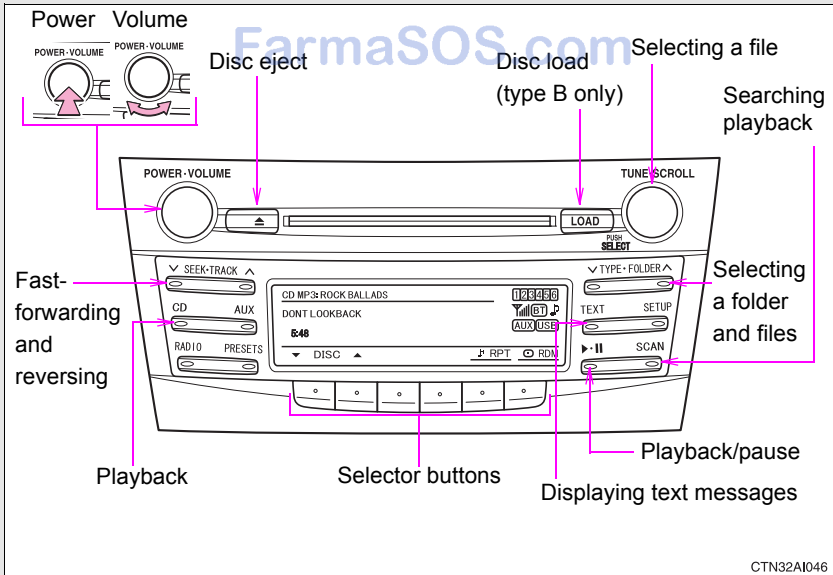

## Loading and ejecting MP3 and WMA discs

→P. 224

## Selecting MP3 and WMA discs (type B only)



→P. 225

## Selecting and scanning a folder



### ■ Selecting folders one at a time

Press “^” or “v” on  or  to select the desired folder.



### ■ Scanning the first file of all the folders

**STEP 1** Press and hold  or  until you hear a beep.

The first ten seconds of the first file in each folder will be played.





**STEP 2** When the desired folder is reached, press  or  again.

### ■ Returning to the first folder

Press and hold “v” on  or  until you hear a beep.



## Selecting and scanning files

### ■ Selecting one file at a time



Turn  or  or press “^” or “v” on  or  to select the desired file.

■ **Selecting the desired file by cueing the files in the folder**

Press  or  .

When the desired file is reached, press  or  once again.

**Fast-forwarding and reversing files**

Type A: Press  (◀◀) or  (▶▶).

Type B and C: Press and hold “^” or “v” on  .

**Playing and pausing files (type B and C)**

Press  .

**Random playback**

■ **Playing files from a particular folder in random order**

Press  (RAND) or  that corresponds to “RDM”.

To cancel, press the same button until “OFF” is displayed.

■ **Playing all of the files on a disc in random order (type B only)**

Press  that corresponds to “RDM” twice.

To cancel, press the button again.

## Repeat play

### ■ Repeating a file

Press  (RPT) or  that corresponds to "RPT".

To cancel, press the same button until "OFF" is displayed.

### ■ Repeating all of the files in a folder

Type A: Press and hold  (RPT) until you hear a beep.

Type B and C: Press  that corresponds to "RPT" twice.

To cancel, press the same button until "OFF" is displayed.

### ■ Repeating all of the files in a disc (type B only)

Press  that corresponds to "RPT" three times.

To cancel, press the same button again.

## Switching the display

Press  or .

Type A: Each time  is pressed, the display changes in the following order:

Folder no./File no./Elapsed time → Folder name → File name → Album title (MP3 only) → Track title → Artist name.

Type B and C: Each time  is pressed, the display changes in the following order:

Track title → Track title/Artist name → Track title/Album name → Track title/Elapsed time.





■ **Display**

→P. 228

■ **Error messages**

“CD CHECK”: This indicates a problem either with the CD or inside the player. The CD may be dirty, damaged or inserted up-side down.

“WAIT” or “PLEASE WAIT”: Operation has stopped due to a high temperature inside the player. Wait for a while and then

press  or  . Contact your Toyota dealer if the CD still cannot be played.

■ **Discs that can be used**

→P. 229

■ **CD player protection feature**

→P. 229

■ **If CDs are left inside the CD player or in the ejected position for extended periods**

→P. 229

■ **Lens cleaners**

→P. 229

امداد خودرو فارما

شکن شبانه روزی

FarmaSOS.com

## ■ MP3 and WMA files

MP3 (MPEG Audio LAYER3) is a standard audio compression format.

Files can be compressed to approximately 1/10 of their original size by using MP3 compression.

WMA (Windows Media <sup>TM</sup> Audio) is a Microsoft audio compression format.

This format compresses audio data to a size smaller than that of the MP3 format.

There is a limit to the MP3 and WMA file standards and to the media/formats recorded by them that can be used.

### ● MP3 file compatibility

- Compatible standards  
MP3 (MPEG1 LAYER3, MPEG2 LSF LAYER3)
- Compatible sampling frequencies  
MPEG1 LAYER3: 32, 44.1, 48 (kHz)  
MPEG2 LSF LAYER3: 16, 22.05, 24 (kHz)
- Compatible bit rates  
MPEG1 LAYER3: 64, 80, 96, 112, 128, 160, 192, 224, 256, 320 (kbps)  
MPEG2 LSF LAYER3: 64, 80, 96, 112, 128, 144, 160 (kbps)  
\* Compatible with VBR
- Compatible channel modes: stereo, joint stereo, dual channel and monaural

### ● WMA file compatibility

- Compatible standards  
WMA Ver. 7, 8, 9
- Compatible sampling frequencies  
32, 44.1, 48 (kHz)
- Compatible bit rates  
Ver. 7, 8: CBR 48, 64, 80, 96, 128, 160, 192 (kbps)  
Ver. 9: CBR 48, 64, 80, 96, 128, 160, 192, 256, 320 (kbps)  
\* Only compatible with 2-channel playback

### ● Compatible media

Media that can be used for MP3 and WMA playback are CD-Rs and CD-RWs.

Playback in some instances may not be possible, depending on the status of the CD-R or CD-RW. Playback may not be possible or the audio may jump if the disc is scratched or marked with fingerprints.

### ● Compatible disc formats

The following disc formats can be used.

- Disc formats: CD-ROM Mode 1 and Mode 2  
CD-ROM XA Mode 2, Form 1 and Form 2
- File formats: ISO9660 Level 1, Level 2, (Romeo, Joliet)  
MP3 and WMA files written in any format other than those listed above may not play correctly, and their file names and folder names may not be displayed correctly.

Items related to standards and limitations are as follows.

- Maximum directory hierarchy: 8 levels
- Maximum length of folder names/file names: 32 characters
- Maximum number of folders: 192 (including the root)
- Maximum number of files per disc: 255 تلفن شبانه روزی:

### ● File names

The only files that can be recognized as MP3/WMA and played are those with the extension .mp3 or .wma.

### ● Multi-sessions

As the audio system is compatible with multi-sessions, it is possible to play discs that contain MP3 and WMA files. However, only the first session can be played.

### ● ID3 and WMA tags

ID3 tags can be added to MP3 files, making it possible to record the track title and artist name, etc.

The system is compatible with ID3 Ver. 1.0, 1.1, and Ver. 2.2, 2.3 ID3 tags. (The number of characters is based on ID3 Ver. 1.0 and 1.1.)

WMA tags can be added to WMA files, making it possible to record the track title and artist name in the same way as with ID3 tags.

### ● MP3 and WMA playback

When a disc containing MP3 or WMA files is inserted, all files on the disc are first checked. Once the file check is finished, the first MP3 or WMA file is played. To make the file check finish more quickly, we recommend you do not write in any files other than MP3 or WMA files or create any unnecessary folders.

If the discs contain a mixture of music data and MP3 or WMA format data, only music data can be played.

### ● Extensions

If the file extensions .mp3 and .wma are used for files other than MP3 and WMA files, they will be mistakenly recognized and played as MP3 and WMA files. This may result in large amounts of interference and damage to the speakers.

### ● Playback

- To play MP3 files with steady sound quality, we recommend a fixed bit rate of 128 kbps and a sampling frequency of 44.1 kHz.
- CD-R or CD-RW playback may not be possible in some instances, depending on the characteristics of the disc.
- There is a wide variety of freeware and other encoding software for MP3 and WMA files on the market, and depending on the status of the encoding and the file format, poor sound quality or noise at the start of playback may result. In some cases, playback may not be possible at all.
- When files other than MP3 or WMA files are recorded on a disc, it may take more time to recognize the disc. In some cases, playback may not be possible at all.
- Microsoft, Windows, and Windows Media are the registered trademarks of Microsoft Corporation in the U.S. and other countries.



#### NOTICE

■ **CDs and adapters that cannot be used (→P. 230)**

■ **CD player precautions (→P. 231)**

## 3-2. Using the audio system Operating an iPod® player\*

Connecting an iPod® player enables you to enjoy music from the vehicle speakers.

### ■ Connecting an iPod® player

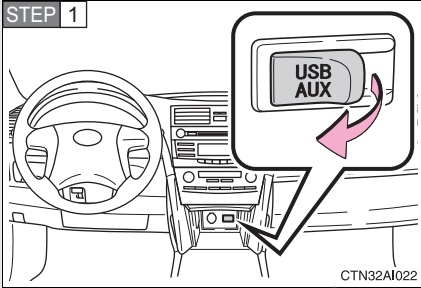

Open the cover and connect an iPod® player using an iPod® cable.



امداد خودرو فارما

### ■ Control panel

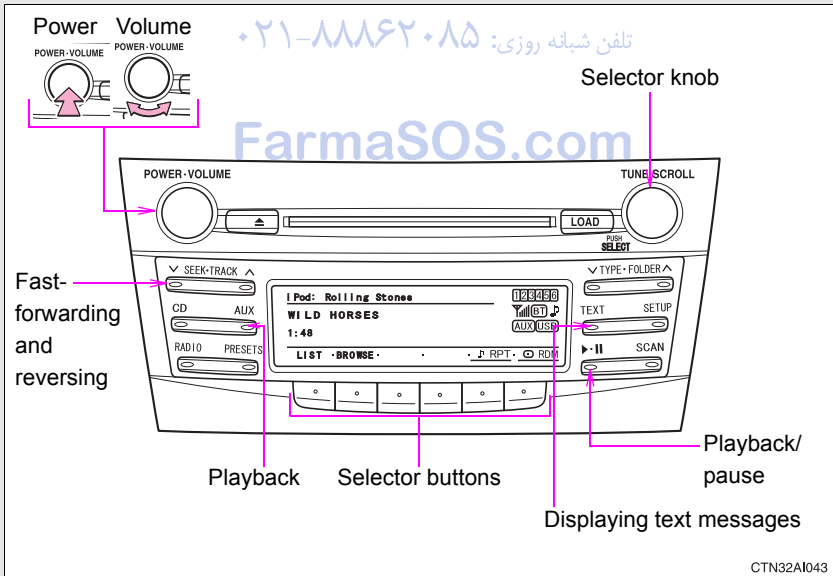

\*: If equipped

## Selecting a play mode

**STEP 1** Press  that corresponds to “BROWSE” to select iPod® menu mode.

**STEP 2** Press  that corresponds to the desired play mode.

### ■ Play mode list

Play mode	First selection	Second selection	Third selection	Fourth selection
PLIST	Playlist select	Songs select	-	-
ARTIST	Artist select	Albums select	Songs select	-
ALBUM	Albums select	Songs select	-	-
GENRE	Genre select	Artists select	Albums select	Songs select
SONGS	Songs select	-	-	-
PODCST	Albums select	Songs select	-	-
COMPSR	Composers select	Albums select	Songs select	-
BOOK	Songs select	-	-	-

Depending on the model, the name of your iPod® may be displayed at the top of the list.

### ■ Selecting a list

**STEP 1** Turn  to display the first selection list.

**STEP 2** Press  to select the desired item.

Pressing  that corresponds to “MORE” changes to the second selection list.

**STEP 3** Repeat the same procedure to select the desired song name.

To return to the previous selection list, press  that corresponds

to “”. 

### Selecting songs from a song list

**STEP 1** Press  that corresponds to “LIST”. 

The current playlist is displayed.

**STEP 2** Turning  to select the desired song. 

Press  returns the screen from list display to the previous screen.

## Selecting songs

Turn  or press “^” or “v” on  to select the desired song.

## Playing and pausing songs

Press .

## Fast-forwarding and reversing songs

Press and hold “^” or “v” on .

## Shuffle playback

### ■ Playing songs from one playlist or album in random order

Press  that corresponds to “RDM”<sup>تلفن شبیه</sup>.

To cancel, press the button twice.

### ■ Playing songs from all the playlists or albums in random order

Press  that corresponds to “RDM” twice.

To cancel, press the button again.

## Repeat play

Press  that corresponds to “RPT”.

To cancel, press the button again.

Even when the repeat play option has not been selected, playback will automatically continue from the first song in the current play list once the last song has ended.



## Switching the display

Press .

Each time  is pressed, the display changes in the following order:

Track title → Track title/Artist name → Track title/Album name → Track title/Elapsed time

### ■ About iPod®

iPod® is registered trademarks of Apple computer, Inc.

### ■ iPod® player functions

- When an iPod® player is connected and the audio source is changed to iPod® player mode, the iPod® player will resume play from the same point in which it was last used.
- Depending on the iPod® player that is connected to the system, certain functions may not be available. Disconnecting the device and reconnecting it once again may resolve some malfunctions.

### ■ iPod® player problems

To resolve most problems encountered when using your iPod® player, disconnect your iPod® player from the vehicle iPod® player connection and reset it.

For instructions on how to reset your iPod® player, refer to your iPod® player Owner's Manual.

### ■ Cable pass-through

→P. 323

### ■ Error messages

“IPOD ERROR”:  
This indicates a problem in the iPod® player, inside the USB box or the connection between them.

“NO SONGS”:  
This indicates that there is no music data in the iPod® player.

“UPDATE YOUR IPOD”:  
This indicates that the version of the iPod® player is not compatible.

### ■ Compatible models

- iPod® 5th generation Version 1.2 or later
- iPod® nano 3rd generation Version 1.0 or later
- iPod® nano 2nd generation Version 1.1.2 or later
- iPod® nano Version 1.2 or later
- iPod® touch Version 1.1 or later
- iPod® classic Version 1.0 or later

iPhone®, iPod® mini, iPod® shuffle, iPod® photo and 4th generation and earlier models of iPod® are not compatible with this system.

Items related to standards and limitations are as follows:

- Maximum number of lists in device: 9999
- Maximum number of songs in device: 65,025
- Maximum number of songs per list: 65,025

### ⚠ CAUTION

#### ■ Caution while driving

Do not connect iPod® players or operate the controls.

### ⚠ NOTICE

#### ■ To prevent damage to iPod® players

- Do not leave iPod® players in the vehicle. The temperature inside may become high, resulting in damage to the player.
- Do not push down on or apply unnecessary pressure to the iPod® player while it is connected as this may damage the iPod® player or its terminal.
- Do not insert foreign objects into the port as this may damage the iPod® player or its terminal.

## 3-2. Using the audio system

# Operating a USB memory player\*

Connecting a USB memory player enables you to enjoy music from the vehicle speakers.

### ■ Connecting a USB memory player

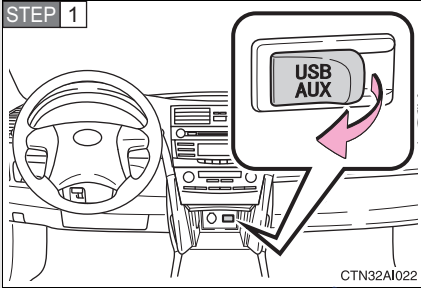

Open the cover and connect a USB memory player.



امداد خودرو فارما

### ■ Control panel

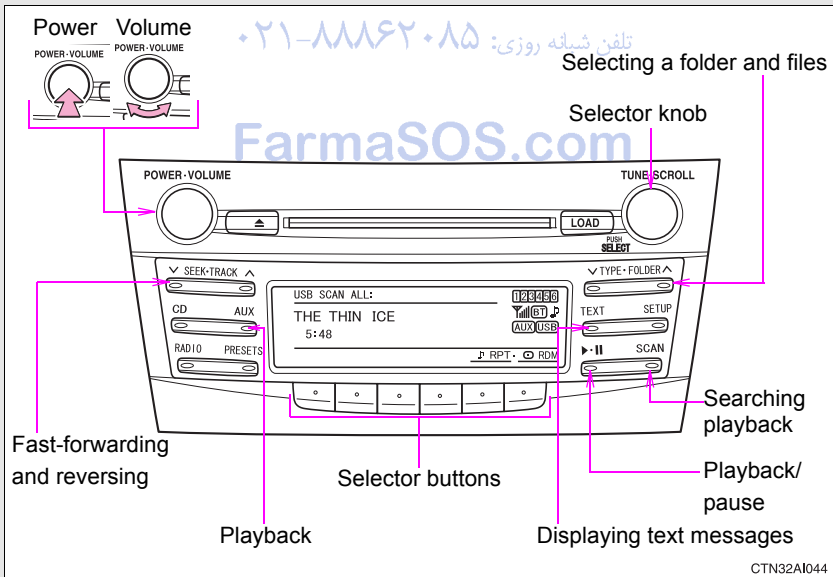

\*: If equipped

## Selecting and scanning a folder

### ■ Selecting a folder

Press “^” or “v” on  to select the desired folder.

### ■ Returning to the first file of the first folder

Press and hold “v” on  until you hear a beep.

### ■ Scanning the first file of all the folders

**STEP 1** Press and hold  until you hear a beep.

The first ten seconds of the first file in each folder will be played.

**STEP 2** When the desired folder is reached, press  again.

## Selecting and scanning files

### ■ Selecting a file

Turn  or press “^” or “v” on  to select the desired file.

### ■ Scanning the files in a folder

Press  .

The first ten seconds of each file will be played.

To cancel, press  again.

When the desired file is reached, press  again.

### Playing and pausing files

Press .

### Fast-forwarding and reversing files

Press and hold “^” or “v” on .

### Random playback

#### ■ Playing files from a folder in random order

Press  that corresponds to “RDM”.

To cancel, press the button twice.

#### ■ Playing all the files from a USB memory player in random order

Press  that corresponds to “RDM” twice.

To cancel, press the button again.

### Repeat play

#### ■ Repeating a file

Press  that corresponds to “RPT”.

To cancel, press the button twice.

#### ■ Repeating all the files in a folder

Press  that corresponds to “RPT” twice.

To cancel, press the button again.

## Switching the display

Press .

Each time  is pressed, the display changes in the following order:

Track title → Track title/Artist name → Track title/Album name → Track title/Elapsed time

### ■ USB memory player functions

Depending on the USB memory player that is connected to the system, certain functions may not be available. Disconnecting the device and reconnecting it once again may resolve some malfunctions.

### ■ Cable pass-through

→P. 323

### ■ Error messages

“USB ERROR”: This indicates a problem either in the USB memory player or inside the USB box or connection between them.

“NO MUSIC”: This indicates that no MP3/WMA files are included in the USB memory player.

### ■ USB memory player

- Compatible device

USB memory players that can be used for MP3 and WMA playback.

Depending on the type of USB device, playback may not be possible.

- Compatible device formats

The following device formats can be used:

- USB communication formats: USB2.0 FS (12 mbps)
- File formats: FAT16/32 (Windows)
- Correspondence class: Mass storage class

MP3 and WMA files written in any format other than those listed above may not play correctly, and their file names and folder names may not be displayed correctly.

Items related to standards and limitations are as follows:

- Maximum directory hierarchy: 8 levels
- Maximum number of folder in device: 999 (including the root)
- Maximum number of files in device: 65,025
- Maximum number of files per folder: 255

- MP3 and WMA files

MP3 (MPEG Audio LAYER 3) is a standard audio compression format.

Files can be compressed to approximately 1/10 of their original size using MP3 compression.

WMA (Windows Media™ Audio) is a Microsoft audio compression format.

This format compresses audio data to a size smaller than that of the MP3 format.

There is a limit to the MP3 and WMA file standards that can be used and to the media/formats on which the files are recorded.

### ● MP3 file compatibility

- Compatible standards  
MP3 (MPEG1 AUDIO LAYERII, III, MPEG2 AUDIO LAYERII, III, MPEG2.5)
- Compatible sampling frequencies  
MPEG1 AUDIO LAYERII, III: 32, 44.1, 48 (kHz)  
MPEG2 AUDIO LAYERII, III: 16, 22.05, 24 (kHz)  
MPEG2.5: 8, 11.025, 12 (kHz)
- Compatible bit rates (compatible with VBR)  
MPEG1 AUDIO LAYERII, III: 32-320 (kbps)  
MPEG2 AUDIO LAYERII, III: 32-160 (kbps)  
MPEG2.5: 32-160 (kbps)
- Compatible channel modes: stereo, joint stereo, dual channel and monaural

### ● WMA file compatibility

- Compatible standards  
WMA Ver. 9
- Compatible sampling frequencies  
HIGH PROFILE 32, 44.1, 48 (kHz)
- Compatible bit rates  
HIGH PROFILE 32-320 (kbps, VBR)

### ● File names

The only files that can be recognized as MP3/WMA and played are those with the extension .mp3 or .wma.

### ● ID3 and WMA tags

ID3 tags can be added to MP3 files, making it possible to record the track title, artist name, etc.

The system is compatible with ID3 Ver. 1.0, 1.1, and Ver. 2.2, 2.3, 2.4 ID3 tags. (The number of characters is based on ID3 Ver. 1.0 and 1.1.)

WMA tags can be added to WMA files, making it possible to record the track title and artist name in the same way as with ID3 tags.

### ● MP3 and WMA playback

When a device containing MP3 or WMA files is plugged, all files in the USB memory device are first checked. Once the file check is finished, the first MP3 or WMA file is played. To make the file check finish more quickly, we recommend you do not write in any files other than MP3 or WMA files or create any unnecessary folders.



● Extensions

If the file extensions .mp3 and .wma are used for files other than MP3 and WMA files, they will be mistakenly recognized and played as MP3 and WMA files. This may result in large amounts of interference and damage to the speakers.

● Playback

- To play MP3 file with steady sound quality, we recommend a fixed bit rate of at least 128 kbps and a sampling frequency of 44.1 kHz.
- There is a wide variety of freeware and other encoding software for MP3 and WMA files on the market, and depending on the status of the encoding and the file format, poor sound quality or noise at the start of playback may result. In some cases, playback may not be possible at all.
- Microsoft, Windows, and Windows Media are the registered trademarks of Microsoft Corporation in the U.S.A. and other countries.

 CAUTION

■ **Caution while driving** تلفن شبانه روزی: ۰۸۵-۸۸۶۲۰۸۵-۲۱

Do not use a USB memory player, or connect a USB memory player.

 NOTICE

■ **To prevent damage to a USB memory player**

- Do not leave a USB memory player in the vehicle. The temperature inside may become high, resulting in damage to the player.
- Do not push down on or apply unnecessary pressure to the USB memory player while it is connected as this may damage the USB memory player or its terminal.
- Do not insert foreign objects into the port as this may damage the USB memory player or its terminal.

## 3-2. Using the audio system

### Optimal use of the audio system

#### ► Type A

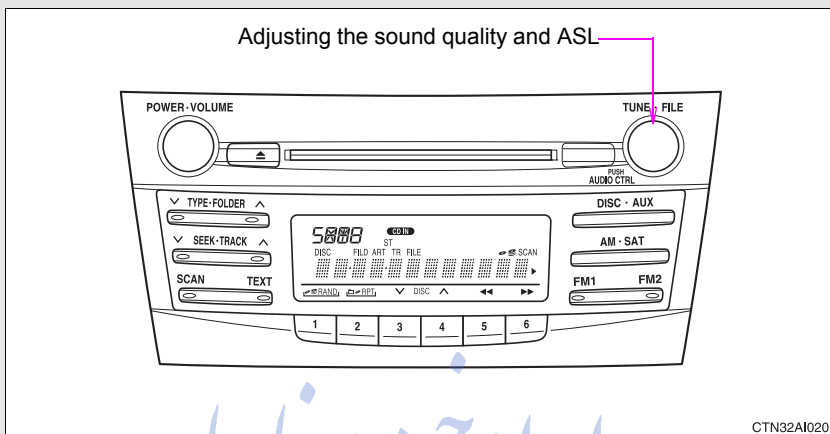

#### ► Type B and C

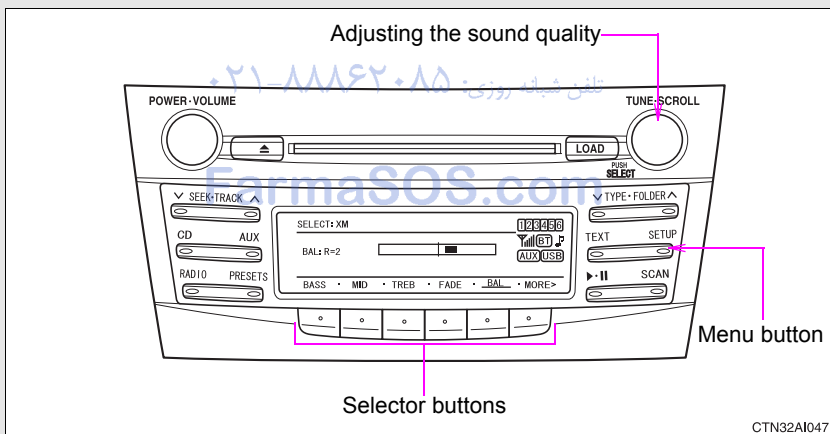

## Using the audio control function

### ■ Changing sound quality modes

#### ► Type A

Pressing  selects the mode to be changed in the following order:



“BAS”→“TRE”→“FAD”→“BAL”→“ASL”

#### ► Type B and C

**STEP 1** Press .

**STEP 2** Press  that corresponds to the desired mode.  
“BASS”, “MID” (type B only), “TREB”, “FADE”, or “BAL”

### ■ Adjusting sound quality

Turning  or  adjusts the level.

#### ► Type A

Mode displayed	Sound quality mode	Level	Turn to the left	Turn to the right
BAS	Bass*	-5 to 5	Low	High
TRE	Treble*	-5 to 5		
FAD	Front/rear volume balance	F7 to R7	Shifts to rear	Shifts to front
BAL	Left/right volume balance	L7 to R7	Shifts to left	Shifts to right

\*: The sound quality level is adjusted individually in each radio mode or CD mode.

► Type B and C

Mode displayed	Sound quality mode	Level	Turn to the left	Turn to the right
BASS	Bass*	-5 to 5	Low	High
MID	Mid-range* (type B only)	-5 to 5		
TREB	Treble*	-5 to 5		
FADE	Front/rear volume balance	F7 to R7	Shifts to rear	Shifts to front
BAL	Left/right volume balance	L7 to R7	Shifts to left	Shifts to right

\*: The sound quality level is adjusted individually in each audio mode.

■ **Adjusting the Automatic Sound Levelizer (ASL)**

► Type A

When “ASL” is selected, turning  to the right changes the “ASL” level in the order of “LOW”, “MID” and “HIGH”.

Turning  to the left turns “ASL” off.

ASL automatically adjusts the volume and tone quality according to vehicle speed.

► Type B and C

**STEP 1** Press  .

**STEP 2** Press  that corresponds to “MORE”.

**STEP 3** Press  that corresponds to “ASL”.

**STEP 4** Press  that corresponds to the desired mode.

Type B: “ON” or “OFF”

Type C: “LOW”, “MID”, “HIGH”, or “OFF”

ASL automatically adjusts the volume and tone quality according to vehicle speed.

■ **Setting the number of preset pages (type B and C)**

The number of preset pages desired can be set from 1 to 6. The initial setting is 6 pages.

**STEP 1** Press  .

**STEP 2** Press  that corresponds to “MORE”.

**STEP 3** Press  that corresponds to “PRESET”.

**STEP 4** Press  that corresponds to the desired number of preset pages.

■ **Language settings (type B and C)**

→P. 213

■ Trademark owned by SRS Labs, Inc. (type A only)



The audio systems utilize SRS FOCUS<sup>®</sup> and SRS TruBass<sup>®</sup> audio enhancement technologies, under license from SRS Labs, Inc., in all modes except AM radio mode.

FOCUS, TruBass, SRS and  symbols are trademarks of SRS Labs, Inc.

FOCUS and TruBass technologies are incorporated under license from SRS Labs, Inc.

امداد خودرو فارما

تلفن شبانه روزی: ۰۲۱-۸۸۶۲۰۸۵

FarmaSOS.com

## 3-2. Using the audio system

### Using the AUX adapter

This adapter can be used to connect a portable audio device and listen to it through the vehicle's speakers.

**STEP 1** Open the cover and connect the portable audio device.

#### ► Type A

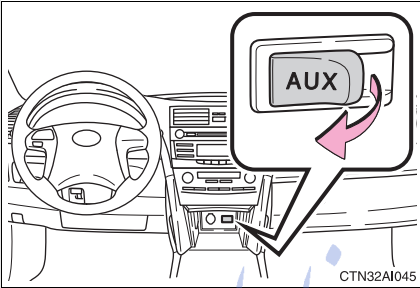

#### ► Type B

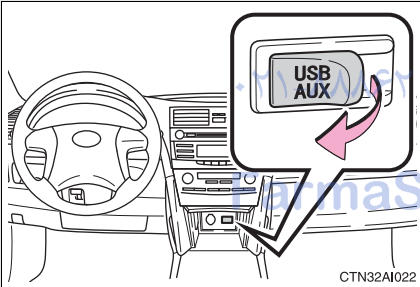

**STEP 2** Press  or  .

---

**■ Operating portable audio devices connected to the audio system**

The volume can be adjusted using the vehicle's audio controls. All other adjustments must be made on the portable audio device itself.

**■ When using a portable audio device connected to the power outlet**

Noise may occur during playback. Use the power source of the portable audio device.

**■ Cable pass-through**

→P. 323

امداد خودرو فارما

تلفن شبانه روزی: ۰۲۱-۸۸۶۲۰۸۵

FarmaSOS.com



## 3-2. Using the audio system

### Using the steering wheel audio switches

Some audio features can be controlled using the switches on the steering wheel.

#### ► 4-spoke steering wheel

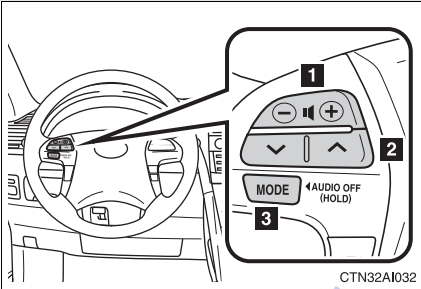

**1** Increases/decreases volume

**2** Radio mode: Select radio stations

CD mode: Select tracks, files (MP3 and WMA) and discs

iPod® player mode:

Selects a song

USB memory player mode:

Selects a file and folder

Bluetooth® audio mode:



Selects a track and album

**3** Turn the power on, selects an audio source

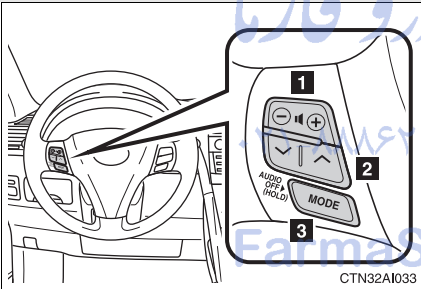
#### ► 3-spoke steering wheel





## Turning the power on

Press  or  when the audio system is turned off.

The audio system can be turned off by holding the switch down until you hear a beep.

## Changing the audio source

Press  or  when the audio system is turned on. The audio source changes as follows each time the switch is pressed. If no discs are inserted in the player, that mode will be skipped.

Type A:

FM1→FM2→CD→AUX→AM→SAT1→SAT2→SAT3

Type B and C:

FM→SAT→CD→CD changer (type B only)→Bluetooth® Audio→AUX→USB/iPod®→AM



## Adjusting the volume



Press “+” on  or  to increase the volume and “-” to decrease the volume.

Press and hold the switch to continue increasing or decreasing the volume.



## Selecting a radio station



**STEP 1** Press  or  to select the radio mode.

**STEP 2** Press “√” or “∧” on  or  to select a radio station.



To scan for receivable stations, press and hold “√” or “∧” on  or  until you hear a beep.



### Selecting a track/file or folder

**STEP 1** Press  or  to select the CD, iPod® player or USB memory player mode.

**STEP 2** Press “√” or “^” on  or  to select the desired track/file or folder.



### Selecting a folder

**STEP 1** Press  or  to select the MP3 and WMA mode.

**STEP 2** Press and hold “√” or “^” on  or  until you hear a beep.

### Selecting a disc in the CD player (CD player with changer only)

**STEP 1** Press  or  to select the CD mode.

**STEP 2** Press and hold “√” or “^” on  or  until you hear a beep.

### CAUTION

#### To reduce the risk of an accident

Exercise care when operating the audio switches on the steering wheel.

### 3-3. Using the Bluetooth® audio system

## Bluetooth® audio system\*

The Bluetooth® audio system enables you to enjoy music played on a portable digital audio player (portable player) from the vehicle speakers via wireless communication.

This audio system supports Bluetooth®, a wireless data system capable of playing portable audio music without cables. If your portable player does not support Bluetooth®, the Bluetooth® audio system will not function.

Owners of models equipped with a navigation system should refer to the “Navigation System Owner's Manual”.

Title	Page
Using the Bluetooth® audio system	P. 266
Operating a Bluetooth® enabled portable player	P. 271
Setting up a Bluetooth® enabled portable player	P. 273
Bluetooth® audio system setup	P. 278

#### ■ Conditions under which the system will not operate

- If using a portable player that does not support Bluetooth®
- If the portable player is switched off
- If the portable player is not connected
- If the portable player's battery is low
- If the portable player is behind the seat or in the glove box or console box
- If metal is covering or touching the portable player

\*: If equipped

#### ■ When transferring ownership of the vehicle

Be sure to initialize the system to prevent personal data from being improperly accessed. (→P. 303)

#### ■ About Bluetooth®



Bluetooth is a registered trademark of Bluetooth SIG, Inc.

#### ■ Compatible models

- Bluetooth® specifications:  
Ver. 1.2
- Following Profiles:
  - A2DP (Advanced Audio Distribution Profile) Ver. 1.0
  - AVRCP (Audio/Video Remote Control Profile) Ver. 1.0 or higher (Ver. 1.3 or higher recommended)

Portable players must correspond to the above specifications in order to be connected to the Bluetooth® audio system. However, please note that some functions may be limited depending on the type of portable player.

#### ■ Certification for the Bluetooth® audio system

##### ▶ Type B

FCC ID: BABFT0001A  
IC ID: 2024B-FT0001A  
MADE IN JAPAN

##### ▶ Type C

FCC ID: ACJ932C5ZZZ035  
IC ID: 216J-C5ZZZ035  
MADE IN JAPAN

This device complies with Part 15 of the FCC Rules and RSS-210 Rules. Operation is subject to the following two conditions; (1) This device may not cause harmful interference, and (2) This device must accept any interference received, including interference that may cause undesired operation.

**⚠ CAUTION****■ FCC WARNING**

Changes or modifications in construction not expressly approved by the party responsible for compliance could void the user's authority to operate the equipment.

Radio frequency exposure. This device is approved for Mobile Application only and, to comply with applicable FCC radio frequency exposure regulations, must be used with a distance of at least 7.9 in. (20 cm) between the antenna and the body of any person at all time during use.

**■ Caution while driving**

Do not connect portable players or operate the controls.

**⚠ NOTICE****■ To prevent damage to portable players**

Do not leave portable players in the vehicle. The temperature inside the vehicle may become high, resulting in damage to the player.

FarmaSOS.com

## 3-3. Using the Bluetooth® audio system

### Using the Bluetooth® audio system

#### ■ Audio unit

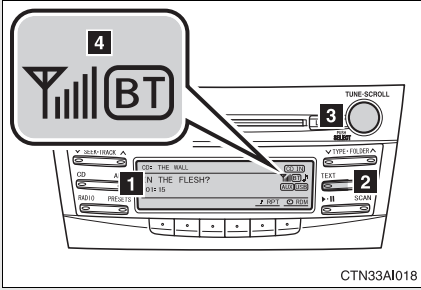

#### 1 Display

A message, name, number, etc. is displayed.

Lower-case characters and special characters cannot be displayed.

#### 2 Displays information that is too long to be displayed at one time on the display (press and hold)

#### 3 Selects items such as menu and number

Turn: Selects an item

Press: Inputs the selected item

#### 4 Bluetooth® connection condition

If "BT" is not displayed, the Bluetooth® audio system cannot be used.

#### ■ Microphone

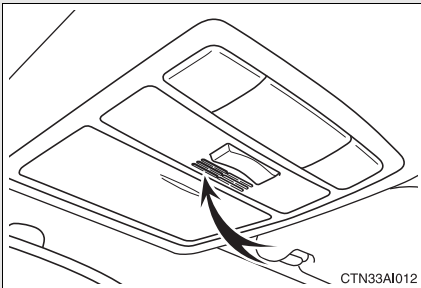

## Operating the system using voice commands

By following voice guidance instructions output from the speaker, voice commands enable the operation of the Bluetooth® audio system without the need to check the display or operate



### ■ Operation procedure when using voice commands

Press the talk switch and follow voice guidance instructions.

### ■ Auxiliary commands when using voice commands

The following auxiliary commands can be used when operating the system using a voice command:

“Cancel”: Exits the Bluetooth® audio system

“Repeat”: Repeats the previous voice guidance instruction

“Go back”: Returns to the previous procedure

“Help”: Reads aloud the function summary if a help comment is registered for the selected function

FarmaSOS.com



### Using the Bluetooth® audio system for the first time

Before using the Bluetooth® audio system, it is necessary to register a Bluetooth® enabled portable player in the system. Follow the procedure below to register (pair) a portable player:

**STEP 1** Press  until “BT AUDIO” is displayed.

**STEP 2** Press  that corresponds to “SETUP”.

The introductory guidance and portable player name registration instructions are heard.

**STEP 3** Select “Pair Audio Player” using a voice command or  .

**STEP 4** Register a portable player name by either of the following methods:

- a. Select “Record Name” using  , and say the name to be registered.
- b. Press the talk switch and say the name to be registered.

A voice guidance instruction to confirm the input is heard.

**STEP 5** Select “Confirm” using a voice command or  .

A passkey is displayed and heard, and a voice guidance instruction for inputting the passkey into the portable player is heard.

**STEP 6** Input the passkey into the portable player.

Refer to the manual that comes with the portable player for the operation of the portable player.

Guidance for registration completion is heard.

If the portable player has a Bluetooth® phone, the phone can be registered at the same time. (→P. 286)

### Menu list of the Bluetooth® audio system

#### ■ Normal operation

First menu	Second menu	Third menu	Operation detail
"Setup"	"BT•A Setup"	"Pair Audio Player"	Registering a portable player
		"Select Audio Player"	Selecting a portable player to be used
		"Change Name"	Changing the registered name of a portable player
		"List Audio Player"	Listing the registered portable players
		"Set Passkey"	Changing the passkey
		"Delete Audio"	Deleting a registered portable player
	"System Setup"	"Guidance Volume"	Setting voice guidance volume
		"Device Name"	Displaying the Bluetooth® device address and name
		"Initialize"	Initializing the system

"BT•A Setup" can be canceled by pressing the on-hook switch or saying the voice command, "Cancel".

■ **When using a voice command**

For numbers, say a combination of single digits from zero to nine.

Say the command correctly and clearly.

■ **Situations that the system may not recognize your voice**

- When driving on rough roads
- When driving at high speeds
- When air is blowing out of the vents onto the microphone
- When the air conditioning fan emits a loud noise

■ **Operations that cannot be performed while driving**

- Operating the system with 
- Registering a portable player to the system

■ **Changing the passkey**

→P. 276

تلفن شبانه روزی: ۰۲۱-۸۸۶۲۰۸۵

FarmaSOS.com

### 3-3. Using the Bluetooth® audio system

## Operating a Bluetooth® enabled portable player

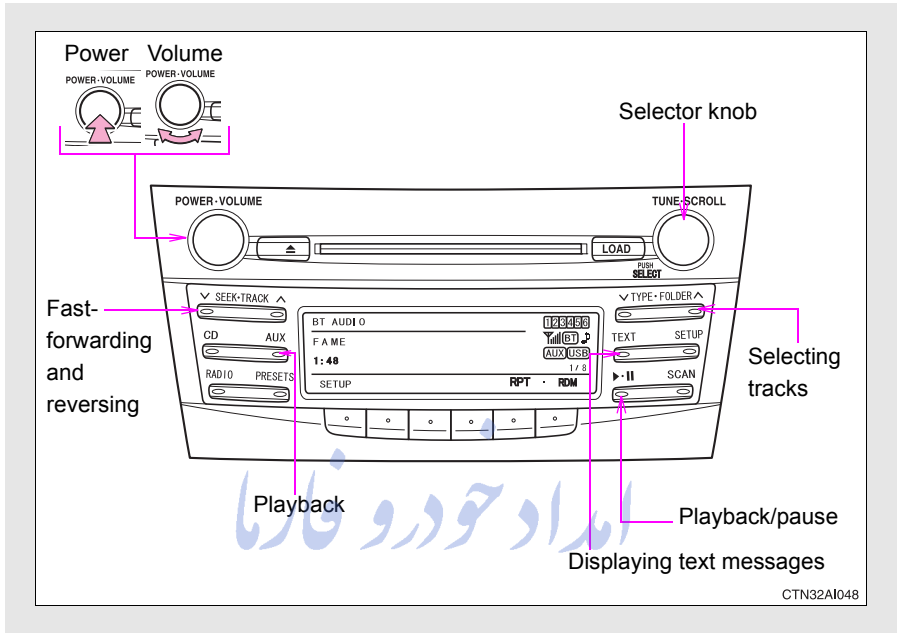

تلفن شبانه روزی: ۰۲۱-۸۸۶۲۰۸۵

### Selecting an album

Press “√” or “^” on  .

### Selecting tracks

Press “^” or “√” on  .

### Playing and pausing tracks

Press  .

### Fast-forwarding and reversing tracks

Press and hold “^” or “v” on .

### Switching the display

Press .

Each time  is pressed, the display changes in the following order:

Track title → Track title/Artist name → Track title/Album name → Track title/Elapsed time

### Using the steering wheel audio switches

→P. 260

#### ■ Bluetooth® audio system functions

Depending on the portable player that is connected to the system, certain functions may not be available.

#### ■ Error messages

“BT AUDIO ERROR”: This indicates a problem in the system.

### 3-3. Using the Bluetooth® audio system

## Setting up a Bluetooth® enabled portable player

Registering a portable player in the Bluetooth® audio system allows the system to function. The following functions can be used for registered portable players:

#### ■ Functions and operation procedures

**STEP 1** Press  until “BT AUDIO” is displayed.

**STEP 2** Press  that corresponds to “SETUP”.

**STEP 3** Select one of the following functions using a voice command or .

- Registering a portable player  
“Pair Audio Player”
- Selecting a portable player to be used  
“Select Audio Player”
- Changing the registered name  
“Change Name”
- Listing the registered portable players  
“List Audio Players”
- Changing the passkey  
“Set Passkey”
- Deleting a registered portable player  
“Delete Audio Player (Delete Audio)”

### Registering a portable player

Select “Pair Audio Player” using a voice command or  , and perform the procedure for registering a portable player. (→P. 268)

### Selecting a portable player to be used

**STEP 1** Select “Select Audio Player” using a voice command or



**STEP 2** Select the portable player to be used by either of the following methods, and select “Confirm” by using a voice command or



- تلفن شبانه روزی: ۰۲۱-۸۸۶۲۰۸۵
- Press the talk switch and say the name of the desired portable player.
  - Press the talk switch and say “List Audio Players”. When the name of the desired portable player is read aloud, press the talk switch.

**STEP 3** Press the talk switch and say “From Car” or “From Audio”, and

select “Confirm” by using a voice command or



Vehicles with smart key system: If “From Car” is selected, the portable player will be automatically connected whenever the “ENGINE START STOP” switch is in either ACCESSORY or IGNITION ON mode.

Vehicles without smart key system: If “From Car” is selected, the portable player will be automatically connected whenever the engine switch is in either the “ACC” or “ON” position.

### Changing the registered name of a portable player

**STEP 1** Select “Change Name” using a voice command or



**STEP 2** Select the name of the portable player to be changed by either of the following methods, and select “Confirm” using a

voice command or



- a. Press the talk switch and say the name of desired portable player.
- b. Press the talk switch and say “List Audio Players”. When the name of the desired portable player is read aloud, press the talk switch.

**STEP 3** Press the talk switch or select “Record Name” using



and say the new name.

**STEP 4** Select “Confirm” using a voice command or





### Listing the registered portable players

Select “List Audio Players” using a voice command or . The list of registered portable players will be read aloud. When listing is complete, the system returns to “BT•A Setup”.

Pressing the talk switch while the name of a portable player is being read aloud selects the portable player, and the following functions will become available:

- Selecting a portable player: “Select Audio Player”
- Changing a registered name: “Change Name”
- Deleting a portable player: “Delete Audio Player (Delete Audio)”

### Changing the passkey

**STEP 1** Select “Set Passkey” using a voice command or .

**STEP 2** Press the talk switch, say a 4 to 8-digit number, and select

“Confirm” using a voice command or .

**STEP 3** When the entire number to be registered as a passkey has

been input, press  again.

If the number to be registered has 8 digits, pressing of the knob is not necessary.

## Deleting a registered portable player

**STEP 1** Select “Delete Audio Player (Delete Audio)” using a voice

command or



**STEP 2** Select the portable player to be deleted by either of the following methods and select “Confirm” using a voice command or



- a. Press the talk switch and say the name of the desired portable player.
- b. Press the talk switch and say “List Audio Players”. When the name of the desired portable player is read aloud, press the talk switch.

If the portable player to be deleted is paired as a Bluetooth® phone, the registration of the mobile phone can be deleted at the same time. A voice guidance instruction to delete a mobile phone is heard.

FarmaSOS.com

**STEP 3** Select “Confirm” by using a voice command or



### ■ The number of portable players that can be registered

Up to 2 portable players can be registered in the system.

### 3-3. Using the Bluetooth® audio system

## Bluetooth® audio system setup

#### ■ System setup items and operation procedures

→P. 301

امداد خودرو فارما

تلفن شبانه روزی: ۰۲۱-۸۸۸۶۲۰۸۵

FarmaSOS.com

### 3-4. Using the hands-free phone system (for cellular phone) Hands-free phone system (for cellular phone) features\*

This system supports Bluetooth®, which allows you to make or receive calls without using cables to connect a cellular phone and the system, and without operating the cellular phone.

Owners of models equipped with a navigation system should refer to the “Navigation System Owner’s Manual”.

#### ■ Hands-free system quick guide

**STEP 1** Setting a cellular phone. (→P. 283)

**STEP 2** Adding an entry to the phonebook (Up to 20 names can be stored). (→P. 305)

**STEP 3** Dialing by inputting a name. (→P. 293)

امداد خودرو فارما

تلفن شبانه روزی: ۰۲۱-۸۸۶۲۰۸۵

FarmaSOS.com

### 3-4. Using the hands-free phone system (for cellular phone)

Title	Page
<p>Using the hands-free phone system</p> <ul style="list-style-type: none"><li>■ Operating the system by using a voice command</li><li>■ Using the hands-free phone system for the first time</li><li>■ Menu list of the hands-free phone system</li></ul>	P. 283
<p>Making a phone call</p> <ul style="list-style-type: none"><li>■ Dialing by inputting a number</li><li>■ Dialing by inputting a name</li><li>■ Speed dialing</li><li>■ When receiving a phone call</li><li>■ Transferring a call</li><li>■ Using the call history memory</li></ul>	P. 292
<p>Setting a cellular phone</p> <ul style="list-style-type: none"><li>■ Registering a cellular phone</li><li>■ Selecting the cellular phone to be used</li><li>■ Changing a registered name</li><li>■ Listing the registered cellular phone</li><li>■ Deleting a cellular phone</li><li>■ Changing the passkey</li><li>■ Turning the hands-free phone automatic connection on/off</li></ul>	P. 296
<p>Security and system setup</p> <ul style="list-style-type: none"><li>■ Setting or changing the PIN</li><li>■ Locking or unlocking the phone book</li><li>■ Setting voice guidance volume</li><li>■ Initialization</li></ul>	P. 301
<p>Using the phone book</p> <ul style="list-style-type: none"><li>■ Adding a new phone number</li><li>■ Setting speed dials</li><li>■ Changing a registered name</li><li>■ Deleting registered data</li><li>■ Deleting speed dials</li><li>■ Listing the registered data</li></ul>	P. 305

■ **Conditions affecting operation**

The hands-free phone system may not operate normally in the following situations:

- The cellular phone is turned off, or located outside the service area.
- The cellular phone has a low battery.
- The cellular phone is not connected to the system.
- The cellular phone is behind the seat or in the glove box, or metal material covers or touches the phone.

■ **When transferring ownership of the vehicle**

Be sure to initialize the system to prevent personal data from being improperly accessed.

■ **Required profiles for the cellular phone**

- HFP (Hands Free Profile) Ver. 1.0
- OPP (Object Push Profile) Ver. 1.1

■ **About Bluetooth®**



Bluetooth is a registered trademark of Bluetooth SIG, Inc.

■ **Certification for the hands-free phone system**

▶ Type B

FCC ID: BABFT0001A  
IC ID: 2024B-FT0001A  
MADE IN JAPAN

▶ Type C

FCC ID: ACJ932C5ZZZ035  
IC ID: 216J-C5ZZZ035  
MADE IN JAPAN

This device complies with Part 15 of the FCC Rules and RSS-210 Rules. Operation is subject to the following two conditions; (1) This device may not cause harmful interference, and (2) This device must accept any interference received, including interference that may cause undesired operation.

 **CAUTION**

■ **FCC WARNING**

Changes or modifications in construction not expressly approved by the party responsible for compliance could void the user's authority to operate the equipment.

Radio frequency exposure. This device is approved for Mobile Application only and, to comply with applicable FCC radio frequency exposure regulations, must be used with a distance of at least 7.9 in. (20 cm) between the antenna and the body of any person at all time during use.

■ **Caution while driving**

Do not use a cellular phone, or connect the Bluetooth® phone.

 **NOTICE**

■ **To prevent damage to a cellular phone**

Do not leave a cellular phone in the vehicle. The temperature inside may become high resulting in damage to the phone.

### 3-4. Using the hands-free phone system (for cellular phone)

### Using the hands-free phone system (for cellular phone)

#### ■ Audio unit

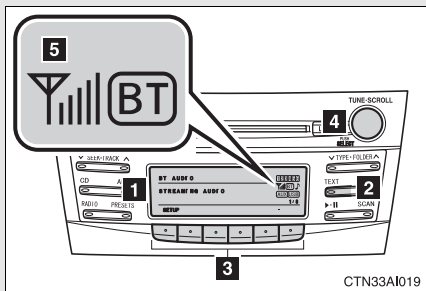

#### 1 Display

A message, name, phone number, etc. is displayed.

Lower-case characters and special characters, such as an umlaut, cannot be displayed.

#### 2 Displays information that is too long to be displayed at one time on the display (press and hold)

#### 3 Selects speed dials

#### 4 Selects items such as menu or number

Turn: Selects an item

Press: Inputs the selected item

#### 5 Bluetooth® connection condition and reception level

If "BT" is not displayed, the hands-free phone system cannot be used.



## ■ Steering wheel

### ▶ 4-spoke steering wheel

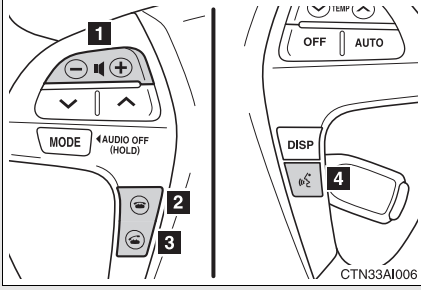

#### 1 Volume

The voice guidance volume cannot be adjusted using this button.

#### 2 On-hook switch

Turns the hands-free system off/ends a call/refuses a call

#### 3 Off-hook switch

Turns the hands-free system on/starts a call

#### 4 Talk switch

Turns the voice command system on (press)/turns the voice command system off (press and hold)

داروخانه فارما

۰۲۱-۸۸۶۲۰۸۵

FarmaSOS.com

► 3-spoke steering wheel

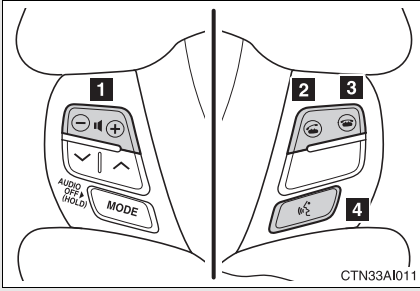

**1** Volume

The voice guidance volume cannot be adjusted using this button.

**2** Off-hook switch

Turns the hands-free system on/starts a call

**3** On-hook switch

Turns the hands-free system off/ends a call/refuses a call

**4** Talk switch

Turns the voice command system on (press)/turns the voice command system off (press and hold)

■ Microphone

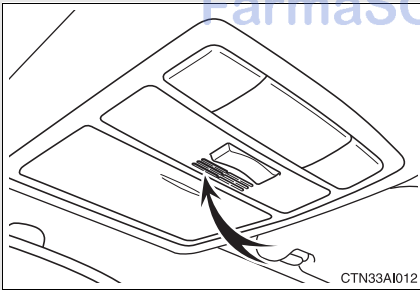

ایران خودرو فارما

تلفن: ۰۲۱-۸۸۶۲۰۸۵

FarmaSOS.com

### Operating the system by using a voice command

By following voice guidance instructions output from the speaker, voice commands enable to the operation of the hands-free phone

system without the need to check the display or operate



#### ■ Operation procedure when using a voice command

Press the talk switch and follow voice guidance instructions.

#### ■ Auxiliary commands when using a voice command

The following auxiliary commands can be used when operating the system using a voice command:

Cancel: Exits the hands-free phone system

Repeat: Repeats the previous voice guidance instruction

Go back: Returns to the previous procedure

Help: Reads aloud the function summary if a help comment is registered for the selected function

تلفن شبانه روزی:

### Using the hands-free phone system for the first time

Before using the hands-free phone system, it is necessary to register a cellular phone in the system. The phone registration mode will be entered automatically when starting the system with no cellular phone registered. Follow the procedure below to register a cellular phone:

**STEP 1** Press the off-hook switch or the talk switch.

The introductory guidance and phone name registration instructions are heard.

**STEP 2** Select “Pair Phone” using a voice command or  .

**STEP 3** Register a phone name by either of the following methods.

a. Select “Record Name” by using  , and say a name to be registered.

b. Press the talk switch and say a name to be registered.

A voice guidance instruction to confirm the input is heard.

**STEP 4** Select “Confirm” by using a voice command or  .

► Registration to the hands-free phone system only

**STEP 5** Select “Phone Only” using a voice command or  .

► Registration to the hands-free phone system and Bluetooth® audio system at the same time

**STEP 5** Select “Internal Audio (Int. Audio)” using a voice command or



**STEP 6** Select “Confirm” by using a voice command or  .

A passkey is displayed and heard, and a voice guidance instruction for inputting the passkey into the cellular phone is heard.

**STEP 7** Input the passkey into the cellular phone.

Refer to the manual that comes with the cellular phone for the operation of the phone.

Guidance for registration completion is heard.

<b>Menu list of the hands-free phone system</b>
---

■ Normal operation

First menu	Second menu	Third menu	Operation detail
Callback	-	-	Dialing a number stored in the incoming call history memory
Redial	-	-	Dialing a number stored in the outgoing call history memory
Dial by number	-	-	Dialing by inputting a number
Dial by name	-	-	Dialing by inputting a name registered in the phone book
Phonebook	Add Entry	-	Adding a new number
	Change Name	-	Changing a name in the phone book
	Delete Entry	-	Deleting the phone book data
	Delete Speed Dial	-	Deleting a registered speed dial
	List Names	-	Listing the phone book data
	Set Speed Dial (Speed Dial)	-	Registering a speed dial

First menu	Second menu	Third menu	Operation detail
Setup	Security	Set PIN	Setting a PIN code
		Phonebook Lock	Locking the phone book
		Phonebook Unlock	Unlocking the phone book
	Phone Setup	Pair Phone	Registering the cellular phone to be used
		Change Name	Changing a registered name of a cellular phone
		Delete Phone	Deleting a registered cellular phone
		List phones	Listing the registered cellular phones
		Select phone	Selecting a cellular phone to be used
		Set Passkey	Changing the passkey
		Hands-free power	Setting a Hands-free power on/off
	System Setup	Guidance Volume	Setting voice guidance volume
		Device Name	Displaying a device information
		Initialize	Initialization

■ Using a short cut key

First menu	Second menu	Operation detail
Dial "XXX (name)"	-	Dialing a number registered in the phone book
Dial "XXX (number)"	-	Dialing the input numbers
Phone book add entry	-	Adding a new number
Phone book change name	-	Changing the name of a phone number in the phone book
Phone book delete entry	-	Deleting phone book data
Phone book set speed dial	-	Registering a speed dial
Phone book delete speed dial	-	Deleting a speed dial
Phonebook	Phonebook Unlock	Unlocking the phone book
	Phonebook Lock	Locking the phone book

FarmaSOS.com

■ **Automatic volume adjustment**

When vehicle speed is 50 mph (80 km/h) or more, the volume automatically increases. The volume returns to the previous volume setting when vehicle speed drops to 43 mph (70 km/h) or less.

■ **When using a voice command**

For numbers, say a combination of single digits from zero to nine, # (pound), \* (star), and + (plus).

Say a command correctly and clearly.

■ **Situations that the system may not recognize your voice**

- When driving on a rough road
- When driving at high speeds
- When air is blowing out of the vents onto the microphone
- When the air conditioning fan emits a loud noise

■ **Operations that cannot be performed while driving**

- Operating the system with  تلفن شبانه روزی: ۰۸۵-۲۸۸۸۰۲۸۸
- Registering a cellular phone to the system

■ **Changing the passkey**

→P. 299

FarmaSOS.com



### 3-4. Using the hands-free phone system (for cellular phone)

## Making a phone call

#### ■ Making a phone call

- Dialing by inputting a number  
“Dial by number”
- Dialing by inputting a name  
“Dial by name”
- Speed dialing
- Dialing a number stored in the outgoing history memory  
“Redial”
- Dialing a number stored in the incoming history memory  
“Call back”

#### ■ Receiving a phone call

- Answering the phone
- Refusing the call

#### ■ Transferring a call

تلفن شبانه روزی: ۰۸۵۰۸۸۶۲-۱

#### ■ Using the call history memory

- Dialing
- Storing data in the phone book
- Deleting

FarmaSOS.com

### Dialing by inputting a number

- STEP 1** Press the talk switch and say “Dial by number”.
- STEP 2** Press the talk switch and say the phone number.
- STEP 3** Dial by one of the following methods:
- Press the off-hook switch.
  - Press the talk switch and say “Dial”.

- c. Select “Dial” by using



## Dialing by inputting a name

**STEP 1** Press the talk switch and say “Dial by name”.

**STEP 2** Select a registered name to be input by either of the following methods:

- Press the talk switch and say a registered name.
- Press the talk switch and say “List names”. Press the talk switch while the desired name is being read aloud.

**STEP 3** Dial by one of the following methods:

- Press the off-hook switch.
- Press the talk switch and say “Dial”.

c. Select “Dial” by using



## Speed dialing

**STEP 1** Press the off-hook switch.

**STEP 2** Press the preset button in which the desired number is registered.

**STEP 3** Press the off-hook switch.

## When receiving a phone call

### ■ Answering the phone

Press the off-hook switch.

### ■ Refusing the call

Press the on-hook switch.

### Transferring a call

A call can be transferred between the cellular phone and system while dialing, receiving a call, or during a call. Use one of the following methods:

- a. Operate the cellular phone.  
Refer to the manual that comes with the cellular phone for the operation of the phone.
- b. Press the off-hook switch\*<sup>1</sup>.
- c. Press the talk switch and say “Call Transfer”\*<sup>2</sup>.

\*<sup>1</sup>: This operation can be performed only when transferring a call from the cellular phone to the system during a call.

\*<sup>2</sup>: While the vehicle is in motion, a call cannot be transferred from the system to the cellular phone.

### Using the call history memory

Follow the procedure below to use a number stored in the call history memory:

**STEP 1** Press the talk switch and say “Redial” (when using a number stored in the outgoing call history memory) or “Call back” (when using a number stored in the incoming call history memory).

**STEP 2** Select the number by either of the following methods:

- a. Say “Previous” or “Go back” until the desired number is displayed.

- b. Select the desired number by using



The following operations can be performed:

Dialing: Press the off-hook switch or select “Dial” by using a voice command or  .

Storing the number in the phone book: Select “Store” by using a voice command or  .

Deleting: Select “Delete” by using a voice command or  .

#### ■ Call history

Up to 5 numbers can be stored in each of the outgoing and incoming call history memories.

#### ■ When talking on the phone

- Do not talk simultaneously with the other party.
- Keep the volume of the received voice down. Otherwise, voice echo will increase.

## 3-4. Using the hands-free phone system (for cellular phone)

### Setting a cellular phone

Registering a cellular phone in the hands-free phone system allows the system to function. The following functions can be used for registered cellular phones:

#### ■ Functions and operation procedures

To enter the menu for each function, follow the steps below by

using a voice command or  :

- Registering a cellular phone
  1. "Setup" → 2. "Phone Setup" → 3. "Pair Phone"
- Selecting the cellular phone to be used
  1. "Setup" → 2. "Phone Setup" → 3. "Select Phone"
- Changing a registered name
  1. "Setup" → 2. "Phone Setup" → 3. "Change Name"
- Listing the registered cellular phones
  1. "Setup" → 2. "Phone Setup" → 3. "List Phones"
- Deleting a cellular phone
  1. "Setup" → 2. "Phone Setup" → 3. "Delete"
- Changing the passkey
  1. "Setup" → 2. "Phone Setup" → 3. "Set Passkey"

#### Registering a cellular phone

Select "Pair Phone" by using a voice command or  , and do the procedure for registering a cellular phone. (→P. 286)

## Selecting the cellular phone to be used

**STEP 1** Select “Select Phone” by using a voice command or



### ► Pattern A

**STEP 2** Select the cellular phone to be used by either of the following methods, and select “Confirm” by using a voice command or



- a. Press the talk switch and say the desired phone name.
- b. Press the talk switch and say “List phones”. While the name of the desired cellular phone is being read aloud, press the talk switch.

### ► Pattern B

**STEP 2** Select the cellular phone to be used by using



## Changing a registered name

**STEP 1** Select “Change Name” by using a voice command or



**STEP 2** Select the name of the cellular phone to be changed by either of the following methods:

- a. Press the talk switch and say the desired phone name, and

select “Confirm” by using a voice command or



- b. Press the talk switch and say “List phones”. While the desired phone name is being read aloud, press the talk switch.

c. Select the desired phone name by using



**STEP 3** Press the talk switch or select “Record Name” by using



and say a new name.

**STEP 4** Select “Confirm” by using a voice command or



### Listing the registered cellular phones

Selecting “List Phones” by using a voice command or



causes

the list of registered cellular phones to be read aloud.

When listing is complete, the system returns to “Phone Setup”.

Pressing the talk switch while the name of a cellular phone is being read selects the cellular phone, and the following functions will be available:

- Selecting a cellular phone: “Select Phone”
- Changing a registered name: “Change Name”
- Deleting a cellular phone: “Delete Phone”

## Deleting a cellular phone

**STEP 1** Select “Delete Phone” by using a voice command or  .

**STEP 2** Select the cellular phone to be deleted by either of the following methods and select “Confirm” by using a voice command

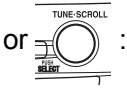

- a. Press the talk switch and say the name of the desired cellular phone.
- b. Press the talk switch and say “List phones”. While the name of the desired cellular phone is being read aloud, press the talk switch.

## Changing the passkey

**STEP 1** Select “Set Passkey” by using a voice command or  .

**STEP 2** Press the talk switch, say a 4 to 8-digit number, and select

“Confirm” by using a voice command or  .

The number should be input 1 digit at a time.

**STEP 3** When the entire number to be registered as a passkey has

been input, press  again.



## Turning the hands-free phone automatic connection on/off

### Turning off the automatic connection

**STEP 1** Select “Handsfree Power” by using a voice command or



**STEP 2** Select “Turn off” by using a voice command or



### Turning on the automatic connection

**STEP 1** Select “Handsfree Power” by using a voice command or



**STEP 2** Select “Turn on” by using a voice command or



### The number of cellular phones that can be registered

Up to 6 cellular phones can be registered in the system.

## 3-4. Using the hands-free phone system (for cellular phone) Security and system setup

To enter the menu of each setting, follow the steps below:

### ■ Security setting items and operation procedure

- Setting or changing the PIN (Personal Identification Number)
  1. "Setup" → 2. "Security" → 3. "Set PIN"
- Locking the phone book
  1. "Setup" → 2. "Security" → 3. "Phonebook Lock"
- Unlocking the phone book
  1. "Setup" → 2. "Security" → 3. "Phonebook Unlock"

### ■ System setup items and operation procedure

- Setting voice guidance volume
  1. "Setup" → 2. "System Setup" → 3. "Guidance Volume"
- Initialization
  1. "Setup" → 2. "System Setup" → 3. "Initialize"

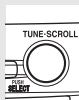

can only be used for system setup operation.

FarmaSOS.com

## Setting or changing the PIN

### ■ Setting a PIN

**STEP 1** Select "Set PIN" by using a voice command or



**STEP 2** Enter a PIN by using a voice command or



When using , input the code 1 digit at a time.

## ■ Changing the PIN

**STEP 1** Select “Set PIN” by using a voice command or



**STEP 2** Enter the registered PIN by using a voice command or



**STEP 3** Enter a new PIN by using a voice command or



When using , input the code 1 digit at a time.

## Locking or unlocking the phone book

**STEP 1** Select “Phonebook lock” or “Phonebook unlock” by using a voice command or  .

**STEP 2** Input the PIN by either of the following methods and select

“Confirm” by using a voice command or  :

a. Press the talk switch and say the registered PIN.

b. Input a new PIN by using  .

## Setting voice guidance volume

**STEP 1** Select “Guidance Volume” by using  .

**STEP 2** Change the voice guidance volume.

To decrease the volume: Turn  counterclockwise.

To increase the volume: Turn  clockwise.

## Initialization

**STEP 1** Select “Initialize” and then “Confirm” by using  .

**STEP 2** Select “Confirm” by using  .

امداد خودرو فارما

تلفن شبانه روزی: ۰۲۱-۸۸۶۲۰۸۵

FarmaSOS.com

### ■ Initialization

- The following data in the system can be initialized:
  - Phone book
  - Outgoing and incoming call history
  - Speed dials
  - Registered cellular phone data
  - Security code
- Once the initialization has been completed, the data cannot be restored to its original state.

### ■ When the phone book is locked

The following functions cannot be used:

- Dialing by inputting a name
- Speed dialing
- Dialing a number stored in the call history memory
- Using the phone book

تلفن شبانه روزی: ۰۲۱-۸۸۶۲۰۸۵

FarmaSOS.com

## 3-4. Using the hands-free phone system (for cellular phone)

### Using the phone book

To enter the menu of each setting, follow the steps below:

- Adding a new phone number
  1. "Phonebook" → 2. "Add Entry"
- Setting speed dial
  1. "Phonebook" → 2. "Set Speed Dial (Speed Dial)"
- Changing a registered name
  1. "Phonebook" → 2. "Change Name"
- Deleting registered data
  1. "Phonebook" → 2. "Delete Entry"
- Deleting speed dial
  1. "Phonebook" → 2. "Delete Speed Dial"
- Listing the registered data
  1. "Phonebook" → 2. "List Names"

تلفن شبانه روزی: ۰۲۱-۸۸۶۲۰۸۵

#### Adding a new phone number

The following methods can be used to add a new phone number:

- Inputting a phone number by using a voice command
- Transferring data from the cellular phone
- Inputting a phone number by using 
- Selecting a phone number from outgoing or incoming call history

## ■ Adding procedure

**STEP 1** Select “Add Entry” by using a voice command or  .

**STEP 2** Use one of the following methods to input a telephone number:

▶ Inputting a telephone number by using a voice command

STEP2-1 Select “By Voice” by using a voice command or



STEP2-2 Press the talk switch, say the desired number, and select “Confirm” by using a voice command.

▶ Transferring data from the cellular phone

STEP2-1 Select “By Phone” and then “Confirm” by using a

voice command or  .

STEP2-2 Transfer the data from the cellular phone.

Refer to the manual that comes with the cellular phone for the details of transferring data.

STEP2-3 Select the data to be registered by either of the following methods:

a. Say “Previous” or “Next” until the desired data is displayed, and select “Confirm” by using a voice command.

b. Select the desired data by using  .

► Inputting a phone number by using



STEP2-1 Select “Manual Input” by using



STEP2-2 Input a phone number by using



, and press



once again.

Input the phone number 1 digit at a time.

► Selecting a phone number from outgoing or incoming call history

STEP2-1 Select “Call History” by using a voice command or



تلفن شبانه روزی: ۰۸۵۶۲۰۸۵

STEP2-2 Select “Outgoing” or “Incoming” by using a voice

command or



STEP2-3 Select the data to be registered by either of the following methods:

a. Say “Previous” or “Go back” until the desired data is displayed, and select “Confirm” by using a voice command.

b. Select the desired data by using





**STEP 3** Select the name to be registered by either of the following methods, and select “Confirm” by using a voice command or



a. Press the talk switch and say the desired name.

b. Select “Record Name” by using , and say the desired name.

**STEP 4** Select “Confirm” by using a voice command or .

In **STEP 3**, selecting “Set Speed Dial (Speed Dial)” instead of “Confirm” registers the newly added phone number as a speed dial.

تلفن شبانه روزی: ۰۲۱-۸۸۶۲۰۸۵

FarmaSOS.com

## Setting speed dials

**STEP 1** Select “Set Speed Dial (Speed Dial)” by using a voice command or

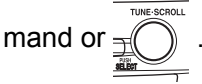

**STEP 2** Select the data to be registered as a speed dial by either of the following methods:

a. Press the talk switch, say desired number, and select “Con-

firm” by using a voice command or



b. Press the talk switch, and say “List names”. While the desired name is being read aloud, press the talk switch,

and select “Confirm” by using a voice command or



c. Select the desired data by using



**STEP 3** Select the desired preset button, and register the data into speed dial by either of the following methods:

a. Press the desired preset button, and select “Confirm” by

using a voice command or



b. Press and hold the desired preset button.

تلفن: شماره روزی: ۰۲۱-۸۸۶۲۰۸۵

FarmaSOS.com

## Changing a registered name

**STEP 1** Select “Change Name” by using a voice command or  .

**STEP 2** Select the name to be changed by either of the following methods.

a. Press the talk switch, say desired name, and select “Con-

firm” by using a voice command or  .

b. Press the talk switch, and say “List names”. While the desired name is being read aloud, press the talk switch,

and select “Confirm” by using a voice command or  .

c. Select the desired name by using  .

**STEP 3** Select “Record Name” with  or the talk switch.

**STEP 4** Say a new name, and select “Confirm” by using a voice com-

mand or  .

### Deleting registered data

**STEP 1** Select "Delete Entry" by using a voice command or  .

**STEP 2** Select the data to be deleted by either of the following methods, and select "Confirm" by using a voice command or



- a. Press the talk switch, and say the name of the desired phone number to be deleted.
- b. Press the talk switch, say "List phones". While the name of the desired phone number is being read aloud, press the talk switch.

### Deleting speed dials

**STEP 1** Select "Delete Speed Dial" by using a voice command or



**STEP 2** Press the preset button in which the desired speed dial is registered, and select "Confirm" by using a voice command or



تلفن شبانه روزی: ۰۲۱-۸۸۶۳۰۸۵

FarmaSOS.com

### **Listing the registered data**

Selecting “List names” by using a voice command causes a list of the registered data to be read aloud.

When listing is complete, the system returns to “Phonebook”. Pressing the talk switch while the desired data is being read aloud selects the data, and the following function will be available.

- Dialing: “Dial”
- Changing a registered name: “Change Name”
- Deleting an entry: “Delete Entry”
- Setting a speed dial: “Set Speed Dial (Speed Dial)”

### **■ Limitation of number of digits**

A phone number that exceeds 24 digits cannot be registered.

تلفن شبانه روزی: ۰۲۱-۸۸۶۲۰۸۵

**FarmaSOS.com**

### 3-5. Using the interior lights

## Interior lights list

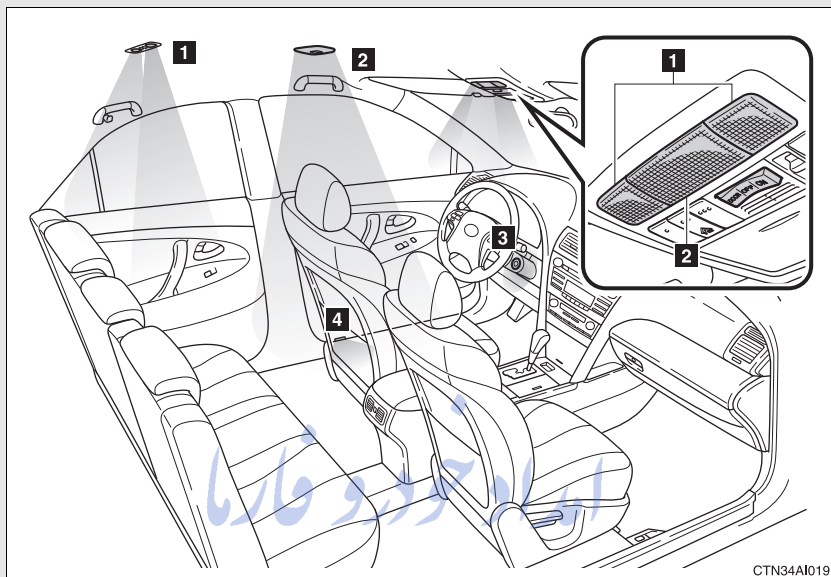

**1** Personal lights (→P. 315)

**2** Interior light (→P. 314)

**3** Engine switch light (vehicles without smart key system)

**4** Front door courtesy light

### ■ Illuminated entry system

The interior light (with the switch in the “DOOR” position) and engine switch light (vehicles without smart key system) automatically turn on/off according to “ENGINE START STOP” switch mode (vehicles with smart key system) or engine switch position (vehicles without smart key system), the presence of the electronic key (vehicles with smart key system), whether the doors are locked/unlocked and whether the doors are open/closed.

### ■ To prevent the battery from being discharged

If the interior light and engine switch light (vehicles without smart key system) remain on when the door is not fully closed and the interior light switch is in the “DOOR” position, the lights will go off automatically after 20 minutes.

### ■ Customization that can be configured at Toyota dealer

Settings (e.g. The time elapsed before lights turn off) can be changed.  
(Customizable features →P. 510)

## Interior light

### ► Vehicles without moon roof

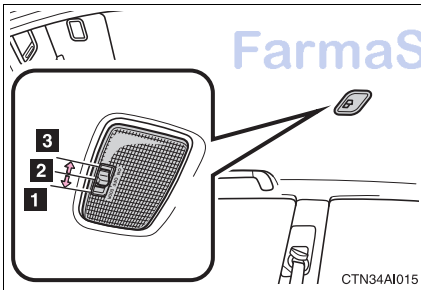

- 1 “DOOR” position
- 2 Off
- 3 On

► Vehicles with moon roof

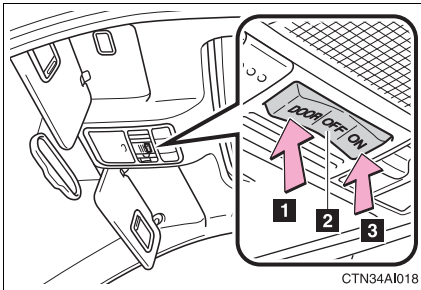

1 "DOOR" position

2 Off

3 On

**Personal lights**

► Front

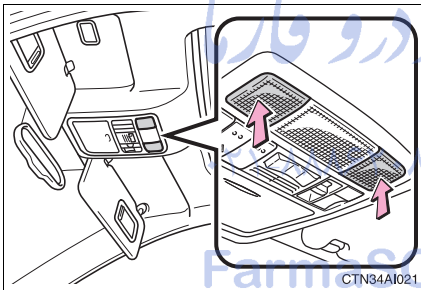

On/off

► Rear (vehicles with moon roof)

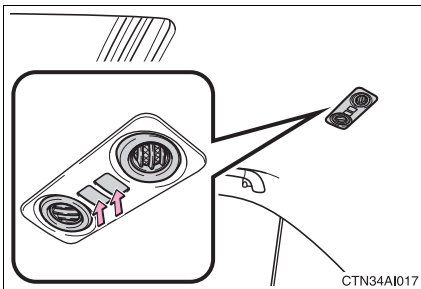

On/off

When either of the rear side doors is opened, the light on that side turns on automatically. Closing the rear side doors will turn the lights off.



### 3-6. Using the storage features

## List of storage features

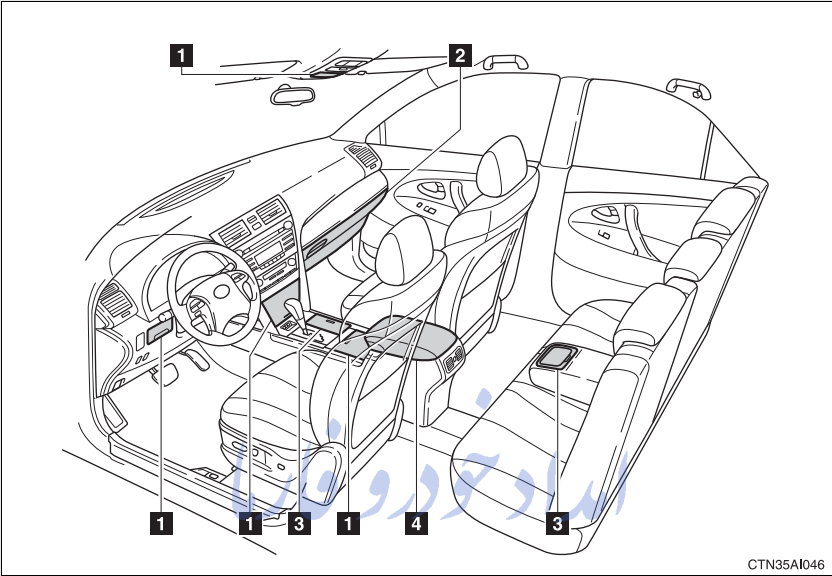

**1** Auxiliary boxes

**2** Glove box

**3** Cup holders

**4** Console box

تلفن شبانه روزی: ۰۲۱-۸۸۶۲۰۸۵

FarmaSOS.com

## Glove box

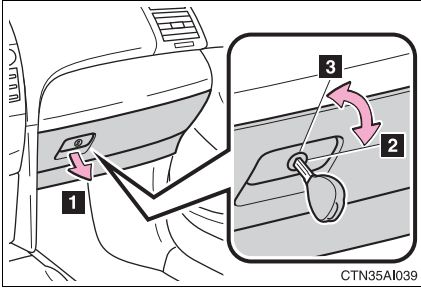

- 1** Open (pull the lever)
- 2** Lock with the master key (vehicles without smart key system) or mechanical key (vehicles with smart key system)
- 3** Unlock with the master key (vehicles without smart key system) or mechanical key (vehicles with smart key system)

### Glove box light

The glove box light turns on when the tail lights are turned on.

### CAUTION

#### Caution while driving

Keep the glove box closed.

Injuries may result in the event of an accident or sudden braking.

## Console box

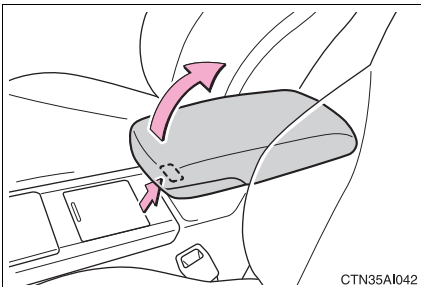

Lift the lid while pulling the lever.

### ■ When using the console box lid as an armrest (if equipped)

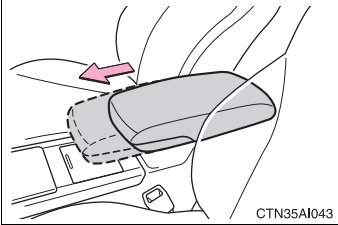

If necessary, the console box lid can slide forward. Pull the lid forward by grasping the front of the lid.

### ■ Tray in the rear console box

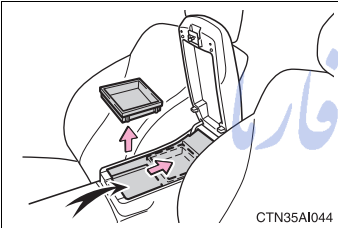

The tray slides forward/backward and can be removed.

امداد خودرو فارما  
تلفن شبانه روزی: ۰۲۱-۸۸۶۲۰۸۵

### ⚠ CAUTION

#### ■ Caution while driving

Keep the console box closed.

Injuries may result in the event of an accident or sudden braking.

FarmaSOS.com

### Cup holders

► Manual transmission

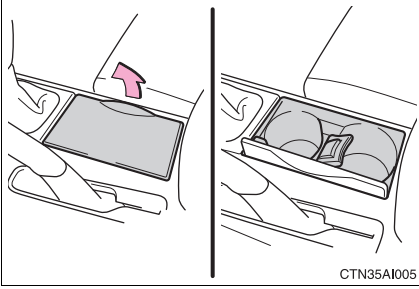

Lift the lid.

► Automatic transmission (type A)

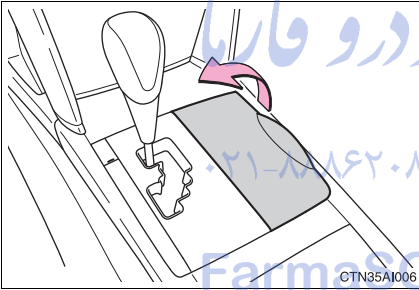

Lift the lid.

► Automatic transmission (type B)

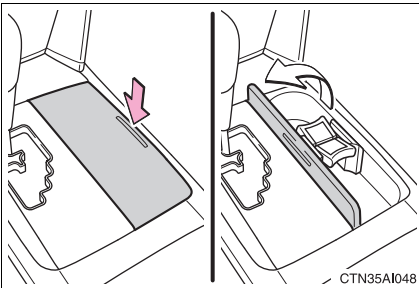

Push the lid.

امداد خودرو فارسیا  
تلفن شبانه روزی: ۰۸۵-۸۳۱۶۲۰۸۵  
FarmaSOS.com

► Rear (type A)

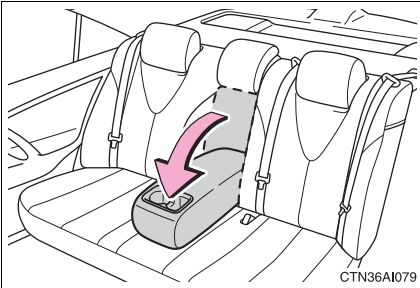

Pull the armrest down.

► Rear (type B)

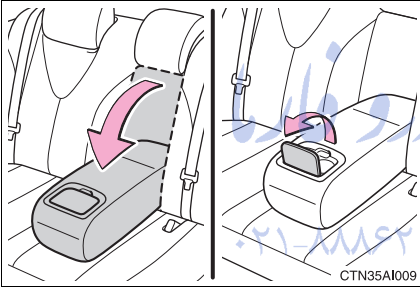

Pull the armrest down and lift the lid.

■ Using the cup holder (front) to store small items (automatic transmission)

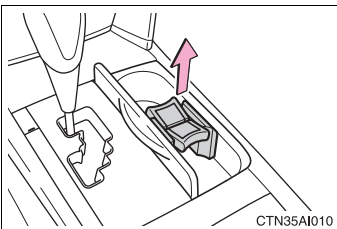

Remove the holder.

**! CAUTION****■ Items unsuitable for the cup holder**

Do not place anything other than cups or aluminum cans in the cup holders. Other items may be thrown out of the holders in the event of an accident or sudden braking and cause injury. If possible, cover hot drinks to prevent burns.

**■ When not in use**

Keep the cup holders closed. Injuries may result in the event of an accident or sudden braking.

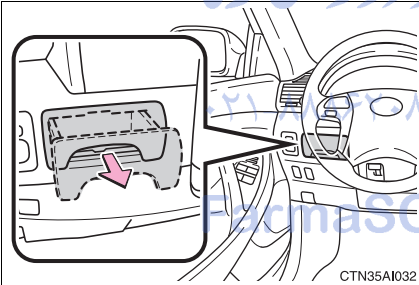
**Auxiliary boxes****► Driver's side instrument panel**

Pull the handle.

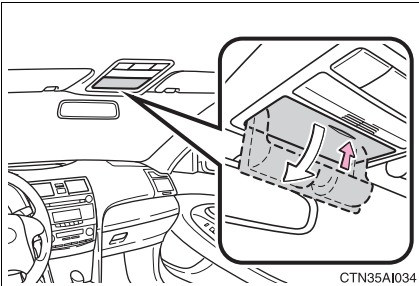
**► Overhead console**

Push the lid.

► Front console

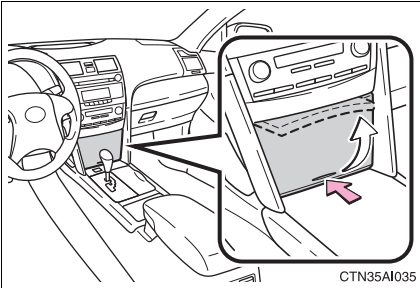

Push the lid.

► Center console (type A)

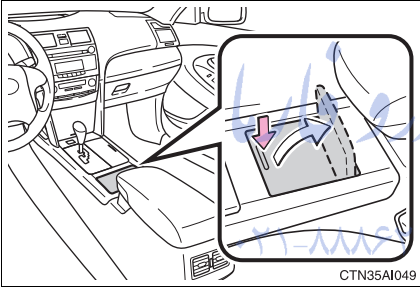

Push the lid.

► Center console (type B)

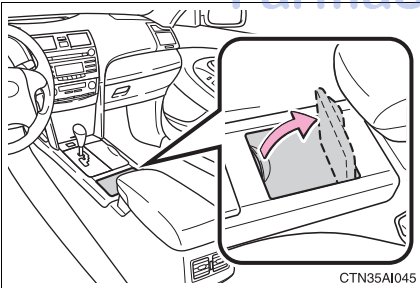

Lift the lid.

### ■ Cable pass-through

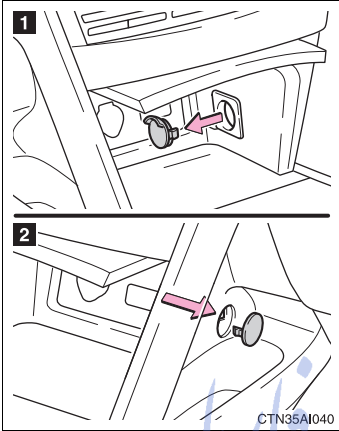

The auxiliary box of the front console is provided with a hole that allows cables to be passed into the cabin from the power outlet and AUX or USB/AUX adapter inside.

- 1 Remove the lid.
- 2 Push out and remove the outer lid.

### ⚠ CAUTION

#### ■ Caution while driving

Keep the auxiliary boxes closed.  
Injuries may result in the event of an accident or sudden braking.

#### ■ Items that should not be left in the overhead console

Do not leave glasses or lighters in the console.  
If the interior of the vehicle becomes hot, lighters may explode and glasses may warp or become cracked.



### 3-7. Other interior features

## Sun visors

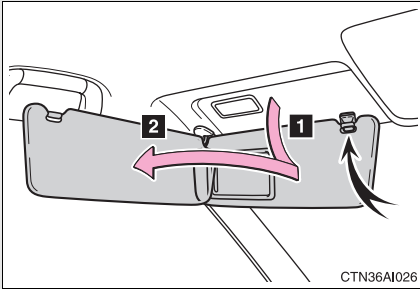

- 1** Forward position:  
Flip down.
- 2** Side position:  
Flip down, unhook, and swing to the side.

امداد خودرو فارما

تلفن شبانه روزی: ۰۲۱-۸۸۸۶۲۰۸۵

FarmaSOS.com

### 3-7. Other interior features

## Vanity mirrors

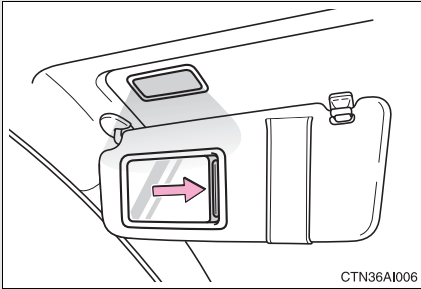

Slide the cover.

The light turns on when the cover is opened. (if equipped)

امداد خودرو فارما

تلفن شبانه روزی: ۰۲۱-۸۸۶۲۰۸۵

FarmaSOS.com

### 3-7. Other interior features

## Clock

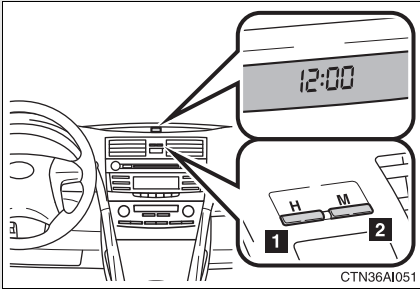

- 1 Adjusts the hour.
- 2 Adjusts the minutes.

#### ■ The clock is displayed when

- ▶ Vehicles with smart key system

The “ENGINE START STOP” switch is in ACCESSORY or IGNITION ON mode.

- ▶ Vehicles without smart key system

The engine switch is in the “ACC” or “ON” position.

FarmaSOS.com

### 3-7. Other interior features

## Ashtray\*

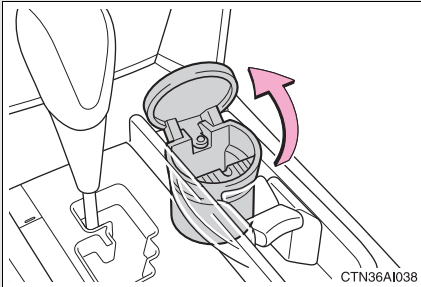

An ashtray can be installed in a cup holder. (→P. 319)

### ⚠ CAUTION

#### ■ When not in use

Keep the ashtray closed.

Injuries may result in the event of sudden braking, sudden swerving or an accident.

#### ■ To prevent fire

- Fully extinguish matches and cigarettes before putting them in the ashtray, then make sure the ashtray is fully closed.
- Do not place paper or any other type of flammable object in the ashtray.

### 3-7. Other interior features

## Power outlets

The power outlet can be used for 12 V accessories that run on less than 10 A.

#### ► Front console

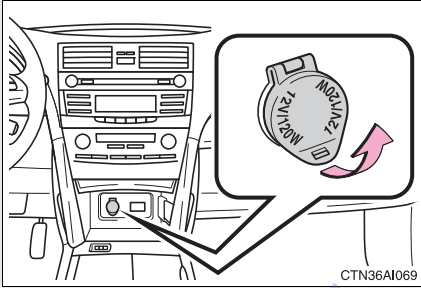

#### ► Center console (if equipped)

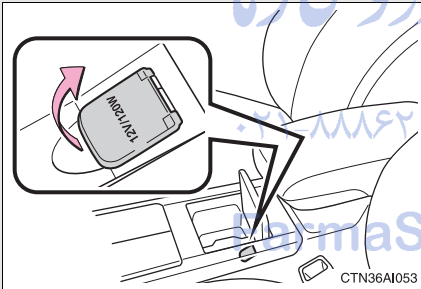

امداد خودرو فارما  
تلفن شبانه روزی: ۰۲۱-۸۸۶۲۰۸۵  
PharmaSOS.com

### ■ The power outlet can be used when

- ▶ Vehicles with smart key system

The “ENGINE START STOP” switch is in ACCESSORY or IGNITION ON mode.

- ▶ Vehicles without smart key system

The engine switch is in the “ACC” or “ON” position.

### ■ Cable pass-through

Connected cables can be passed through the hole in the auxiliary box to the front passenger’s side of the auxiliary box. (→P. 323)

#### NOTICE

#### ■ To avoid damaging the power outlet

Close the power outlet lid when the power outlet is not in use.

Foreign objects or liquids that enter the power outlet may cause a short circuit.

#### ■ To prevent the fuse from being blown

Do not use an accessory that uses more than 12 V 10 A.

#### ■ To prevent the battery from being discharged

Do not use the power outlet longer than necessary when the engine is not running.

### 3-7. Other interior features

## Seat heaters\*

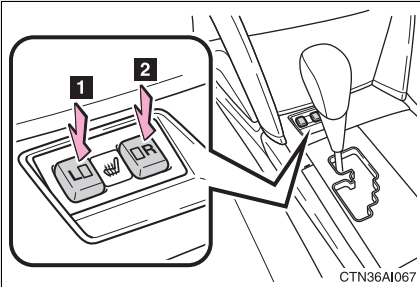

- 1 Heats the driver's seat
- 2 Heats the passenger's seat

The indicator light comes on.

#### ■ The seat heaters can be used when

- ▶ Vehicles with smart key system

The "ENGINE START STOP" switch is in IGNITION ON mode.

- ▶ Vehicles without smart key system

The engine switch is in the "ON" position.

#### ■ When not in use تلفن شبانه روزی: ۰۲۱-۸۸۶۲۰۸۵

Turn the seat heater off. The indicator light turns off.

#### ⚠ CAUTION

#### ■ Burns

- Use caution when seating the following persons in a seat with the seat heater on to avoid the possibility of burns:
  - Babies, small children, the elderly, the sick and the disabled
  - Persons with sensitive skin
  - Persons who are fatigued
  - Persons who have taken alcohol or drugs that induce sleep (sleeping drugs, cold remedies, etc.)
- Do not cover the seat with anything when using the seat heater. Using the seat heater with a blanket or cushion increases the temperature of the seat and may lead to overheating.

\*: If equipped

 NOTICE**■ To prevent seat heater damage**

Do not put unevenly weighted objects on the seat and do not stick sharp objects (needles, nails, etc.) into the seat.

**■ To prevent battery discharge**

Turn the switches off when the engine is not running.

امداد خودرو فارما

تلفن شبانه روزی: ۰۲۱-۸۸۶۲۰۸۵

FarmaSOS.com



### 3-7. Other interior features

## Armrest

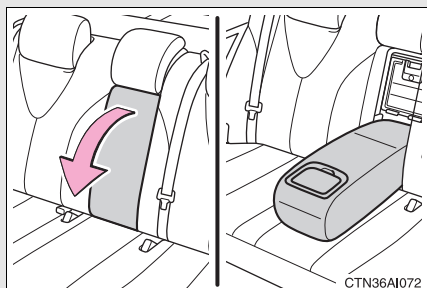

Pull the armrest down for use.

#### NOTICE

#### ■ To prevent damage to the armrest

Do not place too much strain on the armrest.

تلفن شبانه روزی: ۰۲۱-۸۸۶۲۰۸۵

FarmaSOS.com

### 3-7. Other interior features

## Rear sunshade\*

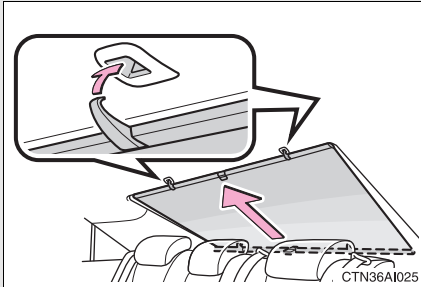

Pull the tab of the shade and hook it on using the anchors. To lower the shade, pull the tab slightly to unhook the shade, and lower it slowly.

#### ⚠ CAUTION

##### ■ When the rear sunshade is being raised or lowered

Do not place fingers or other objects in the fastener section or in the opening. They may get caught, causing injury.

#### ⚠ NOTICE

##### ■ To ensure normal operation of the sunshade

Observe the following precautions.

- Do not place anything where it may hinder the opening/closing of the shade.
- Do not place anything on the shade.

### 3-7. Other interior features

## Trunk storage extension

Long objects can be loaded in the vehicle by utilizing the trunk space and rear seat area.

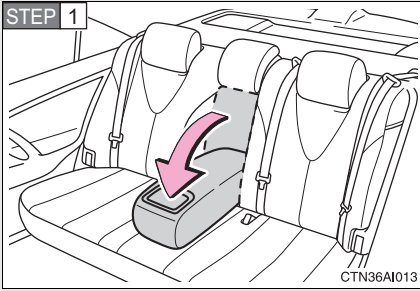

Pull down the armrest.

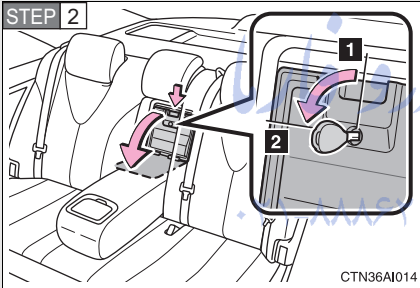

Open the armrest door.

The armrest door can be locked and unlocked using the mechanical key (vehicles with smart key system) or master key (vehicles without smart key system).

- 1 Lock
- 2 Unlock

### CAUTION

#### ■ When not in use

Ensure that the armrest door is closed.

In the event of sudden braking, items stored in the trunk may be thrown forward into the cabin, resulting in injury.

### 3-7. Other interior features

## Floor mat

Securely place a mat that matches the size of the space on the carpet.

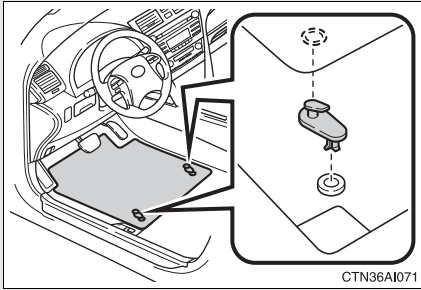

Secure the driver's floor mat using the hooks provided.

#### CAUTION

##### ■ When inserting the floor mat

Observe the following precautions.

Failure to do so may result in the floor mat slipping and interfering with the movement of the pedals during driving, resulting in an accident.

- Make sure the floor mat is properly placed on the vehicle carpet and the correct side faces upward.
- Do not place floor mats on the top of existing mats.

### 3-7. Other interior features

## Trunk features

#### ■ Storage box

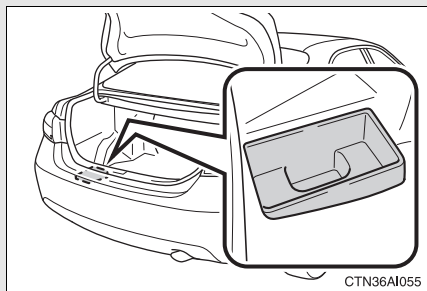

#### ■ Grocery bag hooks

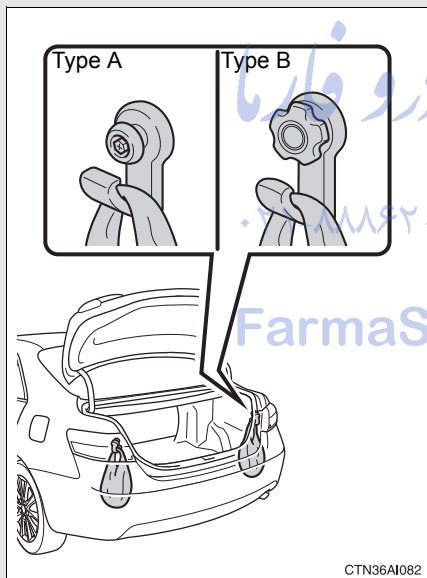

### ■ Cargo net (if equipped)

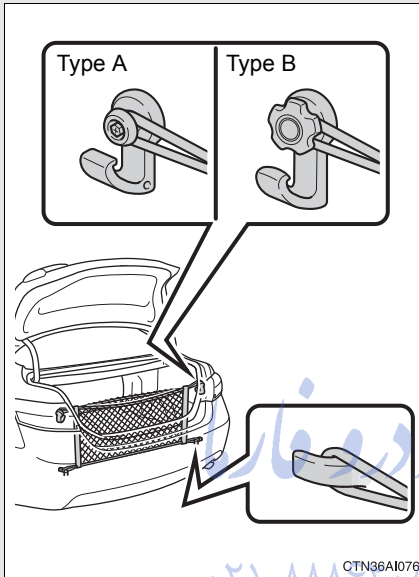

#### ⚠ NOTICE

FarmaSOS.com

#### ■ To prevent damage to the cargo net hooks

Avoid hanging things other than a cargo net on them.

### 3-7. Other interior features

## Garage door opener\*

The garage door opener can be programmed to operate garage doors, gates, entry doors, door locks, home lighting systems, security systems, and other devices.

The garage door opener (HomeLink® Universal Transceiver) is manufactured under license from HomeLink®.

### Programming HomeLink® (for U.S. owners)

To ensure correct programming into the HomeLink®, install a new battery in the hand-held transmitter prior to programming. Failure to install a new battery into the hand-held transmitter will affect both the range and accuracy of the HomeLink® in your vehicle.

The battery side of the hand-held transmitter must be pointed away from the HomeLink® during the programming process.

The HomeLink® compatible transceiver in your vehicle has 3 buttons which can be programmed to operate 3 different devices. Refer to the programming method below appropriate for the device.

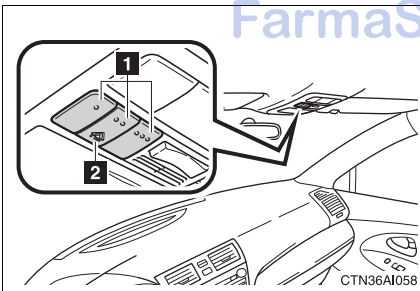

- 1 Buttons
- 2 Indicator

\*: If equipped

## ■ Programming HomeLink®

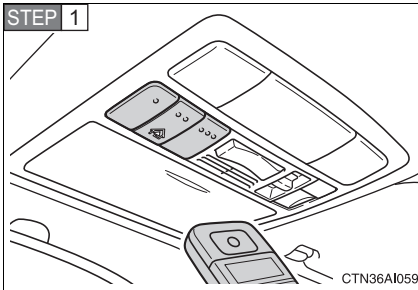

Point the remote control for the device 1 to 3 in. (25 to 75 mm) from the HomeLink® control buttons.

Keep the indicator light on HomeLink® in view while programming.

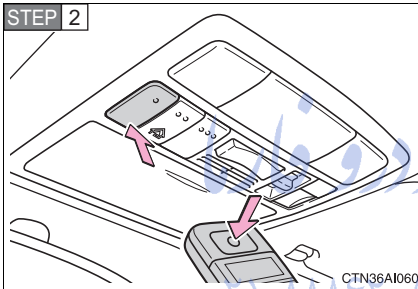

Press and hold down one of the buttons on HomeLink® and the button on the transmitter. When the indicator light on HomeLink® changes from a slow to a rapid flash after 20 seconds, you can release both buttons.

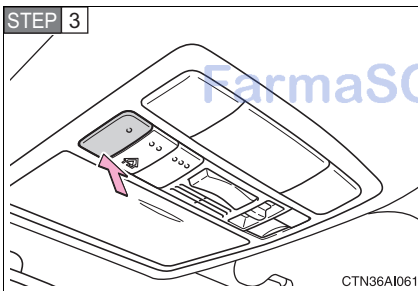

Test the operation of HomeLink® by pressing the newly programmed button.

If programming a garage door opener, check to see if the garage door opens and closes. If the garage door does not operate, see if your garage transmitter is of the Rolling Code type. Press and hold the programmed HomeLink® button. The garage door has the rolling code feature if the indicator light (on HomeLink®) flashes rapidly for 2 seconds and then remains lit. If your transmitter is of the Rolling Code type, proceed to the heading "Programming a rolling code system".



**STEP 4** Repeat the steps above to program another device for each of the remaining HomeLink® buttons.

### ■ Programming a Rolling Code system (for U.S. owners)

If your device is Rolling Code equipped, follow the steps under the heading “Programming HomeLink®” before proceeding with the steps listed below.

**STEP 1** Locate the training button on the ceiling-mounted garage door opener motor. The exact location and color of the button may vary by brand of garage door opener.

Refer to the operation manual supplied with the garage door opener for the location of the training button.

**STEP 2** Press the training button.

**STEP 3** Press and release the vehicle’s programmed HomeLink® button twice. The garage door may open.

If the garage door opens, the programming process is complete. If the door does not open, press and release the button a third time. This third press and release will complete the programming process by opening the garage door.

The ceiling-mounted garage door opener motor should now recognize the HomeLink® transceiver and operate the garage door.

**STEP 4** Repeat the steps above to program another rolling code system for any of the remaining HomeLink® buttons.

### ■ Programming an entry gate (for U.S. owners)/Programming all devices in the Canadian market

**STEP 1** Place your transmitter 1 to 3 in. (25 to 75 mm) away from the surface of HomeLink®.

Keep the indicator light on HomeLink® in view while programming.

**STEP 2** Press and hold the selected HomeLink® button.

**STEP 3** Repeatedly press and release (cycle) the device’s remote control button for two seconds each until step 4 is complete.

**STEP 4** When the indicator light on the HomeLink® compatible transceiver starts to flash rapidly, release the buttons.

**STEP 5** Test the operation of HomeLink<sup>®</sup> by pressing the newly programmed button. Check to see if the gate/device operates correctly.

**STEP 6** Repeat the steps above to program another device for each of the remaining HomeLink<sup>®</sup> buttons.

### ■ Programming other devices

To program other devices such as home security systems, home door locks or lighting, contact your authorized Toyota dealer for assistance.

### ■ Reprogramming a button

The individual HomeLink<sup>®</sup> buttons cannot be erased but can be reprogrammed. To reprogram a button, follow the “Programming” instructions.

## Operating HomeLink<sup>®</sup>

Press the appropriate HomeLink<sup>®</sup> button. The HomeLink<sup>®</sup> indicator light on the HomeLink<sup>®</sup> transceiver should turn on.

HomeLink<sup>®</sup> continues to send a signal for up to 20 seconds as long as the button is pressed.

## Erasing the entire HomeLink<sup>®</sup> memory (all three programs)

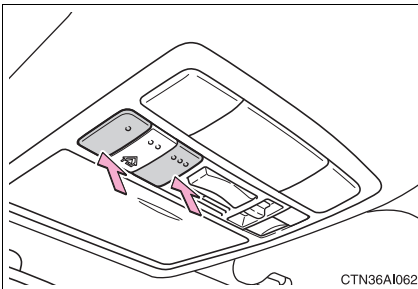

Press and hold down the 2 outside buttons for 20 seconds until the indicator light flashes.

If you sell your vehicle, be sure to erase the programs stored in the HomeLink<sup>®</sup> memory.

■ **Before programming**

- Install a new battery in the transmitter.
- The battery side of the transmitter must be pointed away from HomeLink®.

■ **Certification for the garage door opener**

This device complies with Part 15 of the FCC Rules and with RSS-210 of the IC Rules.

Operation is subject to the following two conditions: (1) This device may not cause harmful interference, and (2) this device must accept any interference received, including interference that may cause undesired operation.

WARNING: This transmitter has been tested and complies with FCC and IC rules. Changes or modifications not expressly approved by the party responsible for compliance could void the user's authority to operate the device.

 **CAUTION**

■ **When programming a garage door or other remote control device**

The garage door may operate, so ensure people and objects are out of danger to prevent potential harm.

■ **Conforming to federal safety standards**

Do not use the HomeLink® compatible transceiver with any garage door opener or device that lacks safety stop and reverse features as required by federal safety standards.

This includes any garage door that cannot detect an obstruction object. A door or device without these features increases the risk of death or serious injury.

### 3-7. Other interior features

## Compass\*

The compass on the inside rear view mirror indicates the direction in which the vehicle is heading.

#### ■ Operation

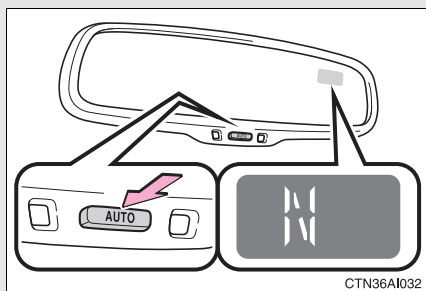

To turn the compass on or off, press and hold "AUTO" for 3 seconds.

#### ■ Displays and directions

Display	Direction
N	North
NE	Northeast
E	East
SE	Southeast
S	South
SW	Southwest
W	West
NW	Northwest

## Calibrating the compass

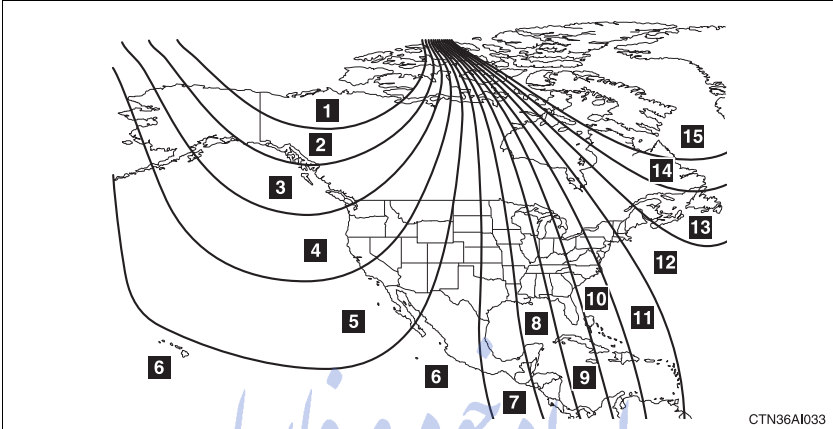

The direction display deviates from the true direction determined by the earth's magnetic field. The amount of deviation varies according to the geographic position of the vehicle.

If you cross over a map boundary shown in the illustration, the compass will deviate.

To obtain higher precision or perfect calibration, refer to the following.

### ■ Deviation calibration

**STEP 1** Stop the vehicle in a place where it is safe to drive in a circle.

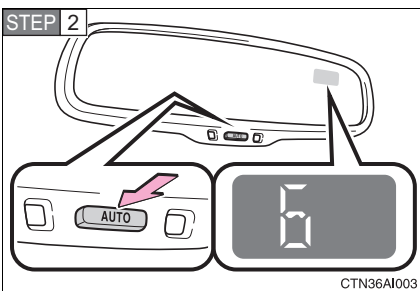

Press and hold "AUTO" for 6 seconds.

A number (1 to 15) appears on the compass display.

**STEP 3** Press "AUTO" and, referring to the map above, select the number of the zone where you are.

If the direction is displayed several seconds after adjustment, the calibration is complete.

## ■ Circling calibration

**STEP 1** Stop the vehicle in a place where it is safe to drive in a circle.

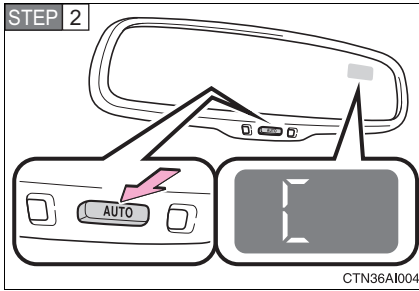

Press and hold "AUTO" for 9 seconds.

C appears on the compass display.

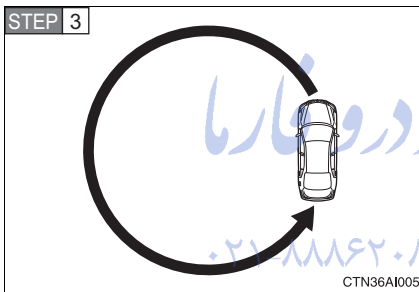

Drive the vehicle at 5 mph (8 km/h) or less in a circle until a direction is displayed.

If there is not enough space to drive in a circle, drive around the block until the direction is displayed.

## ■ Conditions unfavorable for correct operation

The compass may not show the correct direction in the following situations:

- The vehicle is stopped immediately after turning.
- The vehicle is on an inclined surface.
- The vehicle is in a place where the earth's magnetic field is subject to interference by artificial magnetic fields (underground car park/parking lot, under a steel tower, between buildings, roof car park/parking lot, near an intersection, near a large vehicle, etc.).
- The vehicle has become magnetized.  
(There is a magnet or metal object near the anti-glare inside rear view mirror.)
- The battery has been disconnected.
- A door is open.

 CAUTION

■ **While driving the vehicle**

Do not adjust the display. Be sure to adjust the display only when the vehicle is stopped.

■ **When doing the circling calibration**

Be sure to secure a wide space, and watch out for people and vehicles in the neighborhood. Do not violate any local traffic rules while performing circling calibration.

 NOTICE

■ **To avoid compass malfunctions**

Do not place magnets or any metal objects near the anti-glare inside rear view mirror.

Doing this may cause a malfunction of the compass sensor.

■ **To ensure normal operation of the compass**

● Do not perform circling calibration of the compass in a place where the earth's magnetic field is subject to interference by artificial magnetic fields.

● During calibration, do not operate electric systems (moon roof, power windows, etc.) as they may interfere with the calibration.

## 4-1. Maintenance and care

# Cleaning and protecting the vehicle exterior

**Perform the following to protect the vehicle and maintain it in prime condition:**

- Working from top to bottom, liberally apply water to the vehicle body, wheel wells and underside of the vehicle to remove any dirt and dust.
- Wash the vehicle body using a sponge or soft cloth, such as a chamois.
- For hard-to-remove marks, use car wash soap and rinse thoroughly with water.
- Wipe away any water.
- Wax the vehicle when the waterproof coating deteriorates.

If water does not bead on a clean surface, apply wax when the vehicle body is cool.

---

### ■ Automatic car washes

- Fold the mirrors back before washing the vehicle.
- Brushes used in automatic car washes may scratch the vehicle surface and harm your vehicle's paint.

### ■ High pressure car washes

- Do not allow the nozzles of the car wash to come within close proximity of the windows.
- Before car wash, check that the fuel filler door on your vehicle is closed properly.

### ■ Aluminum wheels (if equipped)

Remove any dirt immediately by using a neutral detergent. Do not use hard brushes or abrasive cleaners. Do not use strong or harsh chemical cleaners. Use the same mild detergent and wax as used on the paint.

### ■ Bumpers

Do not scrub with abrasive cleaners.



### ■ To prevent deterioration and body corrosion

- Wash the vehicle immediately in the following cases:
  - After driving near the sea coast
  - After driving on salted roads
  - If you see coal tar or tree sap on the paint surface
  - If you see dead insects or insect droppings on the paint
  - After driving in an area contaminated with soot, oily smoke, mine dust, iron powder or chemical substances
  - If the vehicle becomes heavily soiled in dust or mud
  - If liquids such as benzene and gasoline are spilled on the paint surface
- If the paint is chipped or scratched, have it repaired immediately.

#### CAUTION

##### ■ Caution about the exhaust pipe

Exhaust gasses cause the exhaust pipe to become quite hot.

When washing the vehicle, be careful not to touch the pipe until it has cooled sufficiently, as touching a hot exhaust pipe can cause burns.

#### NOTICE

##### ■ To protect your vehicle's painted surfaces

Do not use organic cleaners such as benzene or gasoline.

##### ■ Cleaning the exterior lights

- Wash carefully. Do not use organic substances or scrub with a hard brush. This may damage the surfaces of the lights.
- Do not apply wax on the surfaces of the lights. Wax may cause damage to the lenses.

# Cleaning and protecting the vehicle interior

The following procedures will help protect your vehicle's interior and keep it in top condition:

### ■ Protecting the vehicle interior

Remove dirt and dust using a vacuum cleaner. Wipe dirty surfaces with a cloth dampened with lukewarm water.

### ■ Cleaning the leather areas

- Remove dirt and dust using a vacuum cleaner.
- Wipe any excess dirt and dust with a soft cloth dampened with diluted detergent.

Use a diluted water solution of approximately 5% neutral wool detergent.

- Wring out any excess water from the cloth and thoroughly wipe off all remaining traces of detergent.
- Wipe the surface with a dry, soft cloth to remove any remaining moisture. Allow the leather to dry in a shaded ventilated area.

### ■ Synthetic leather areas

- Remove loose dirt using a vacuum cleaner.
- Apply a mild soap solution to the synthetic leather.
- Allow the solution to soak in for a few minutes. Remove the dirt and wipe off the solution with a clean, damp cloth.

### ■ Caring for leather areas

Toyota recommends cleaning the interior of the vehicle at least twice a year to maintain the quality of the vehicle's interior.

### ■ Shampooing the carpets

There are several commercial foaming-type cleaners available. Use a sponge or brush to apply the foam. Rub in overlapping circles. Do not apply water. Excellent results are obtained by keeping the carpet as dry as possible.

### ■ Seat belts

Clean with mild soap and lukewarm water using a cloth or sponge. Also check the belts periodically for excessive wear, fraying or cuts.

### ▲ CAUTION

#### ■ Water in the vehicle

- Do not splash or spill liquid in the vehicle.  
Doing so may cause electrical components etc. to malfunction or catch fire.
  - Do not get any of the SRS components or wiring in the vehicle interior wet.  
(→P. 88)
- Electrical malfunction may cause the airbags to deploy or not function properly, resulting in death or severe injury.

 NOTICE

■ **Cleaning detergents**

Do not use organic substances such as benzene or gasoline, acidic or alkaline solutions, dye, bleach or other detergent. Doing so may discolor the vehicle interior or cause streaks or damage to painted surfaces.

■ **Preventing damage to leather surfaces**

Observe the following precautions to avoid damage to and deterioration of leather surfaces.

- Remove any dust or dirt on leather surfaces immediately.
- Do not expose the vehicle to direct sunlight for extended periods of time. Park the vehicle in the shade, especially during summer.
- Do not place items made of vinyl, plastic, or that contain wax, on the upholstery, as they may stick to the leather surface if the vehicle interior heats up significantly.

■ **Water on the floor**

Do not wash the vehicle floor with water.

Vehicle systems such as the audio system may be damaged if water comes into contact with electrical components under the floor of the vehicle, and may also cause the body to rust.

■ **Cleaning the inside of the rear window**

- Do not use glass cleaner to clean the rear window, as this may cause damage to the rear window defogger heater wires or antenna. Use a cloth dampened with lukewarm water to gently wipe the window clean. Wipe the window in strokes running parallel to the heater wires or antenna.
- Be careful not to scratch or damage the heater wires or antenna.

# Maintenance requirements

To ensure safe and economical driving, day-to-day care and regular maintenance is essential. It is the owner's responsibility to perform regular checks. Toyota recommends the following maintenance.

### ■ General maintenance

Should be performed on a daily basis. This can be done by yourself or by a Toyota dealer.

### ■ Scheduled maintenance

Should be performed at specified intervals according to the maintenance schedule.

For details about maintenance items and schedules, refer to the "Scheduled Maintenance Guide" or "Owner's Manual Supplement".

### ■ Do-it-yourself maintenance

You can perform some maintenance procedures yourself. Please be aware that do-it-yourself maintenance may affect warranty coverage.

The use of Toyota Repair Manuals is recommended.

For details about warranty coverage, see the separate "Owner's Warranty Information Booklet", "Owner's Manual Supplement".

### ■ Repair and replacement

It is recommended that genuine Toyota parts be used for repair to ensure performance of each system. If non-Toyota parts are used in replacement or if a repair shop other than a Toyota dealer performs repairs, confirm the warranty coverage.

■ **Allow inspection and repairs to be performed by a Toyota dealer**

- Toyota technicians are well-trained specialists and are kept up to date with the latest service information. They are well informed about the operations of all systems on your vehicle.
- Keep a copy of the repair order. It proves that the maintenance that has been performed is under warranty coverage. If any problem should arise while your vehicle is under warranty, your Toyota dealer will promptly take care of it.

 **CAUTION**

■ **Warning in handling of battery**

- Engine exhaust, some of its constituents, and a wide variety of automobile components contain or emit chemicals known to the State of California to cause cancer and birth defects and other reproductive harm. Work in a well ventilated area.
- Oils, fuels and fluids contained in vehicles as well as waste produced by component wear contain or emit chemicals known to the State of California to cause cancer and birth defects or other reproductive harm. Avoid exposure and wash any affected area immediately.
- Battery posts, terminals and related accessories contain lead and lead compounds which are known to cause brain damage. Wash your hands after handling. (→P. 378)

## 4-2. Maintenance

### General maintenance

Listed below are the general maintenance items that should be performed at the intervals specified in the “Owner's Warranty Information Booklet” or “Owner's Manual Supplement/Scheduled Maintenance Guide”. It is recommended that any problem you notice should be brought to the attention of your Toyota dealer or qualified service shop for advice.

#### Engine compartment

Items	Check points
Battery	Check the connections. (→P. 378)
Brake fluid	At the correct level? (→P. 375)
Engine coolant	At the correct level? (→P. 373)
Engine oil	At the correct level? (→P. 368)
Exhaust system	No fumes or strange sounds?
Power steering fluid	At the correct level? (→P. 376)
Radiator/condenser/hoses	Not blocked with foreign matter? (→P. 374)
Washer fluid	At the correct level? (→P. 381)

<b>Vehicle interior</b>
-------------------------

Items	Check points
Accelerator pedal	<ul style="list-style-type: none"> <li>• Moves smoothly (without uneven pedal effort or catching)?</li> </ul>
Automatic transmission “Park” mechanism	<ul style="list-style-type: none"> <li>• Can the vehicle be held securely on an incline with the shift lever in P?</li> </ul>
Brake pedal	<ul style="list-style-type: none"> <li>• Moves smoothly?</li> <li>• Does it have appropriate clearance and correct amount of free play?</li> </ul>
Brakes	<ul style="list-style-type: none"> <li>• Not pull to one side when applied?</li> <li>• Loss of brake effectiveness?</li> <li>• Spongy feeling brake pedal?</li> <li>• Pedal almost touches floor?</li> </ul>
Clutch pedal	<ul style="list-style-type: none"> <li>• Moves smoothly?</li> </ul>
Head restraints	<ul style="list-style-type: none"> <li>• Move smoothly and lock securely?</li> </ul>
Indicators/buzzers	<ul style="list-style-type: none"> <li>• Function properly?</li> </ul>
Lights	<ul style="list-style-type: none"> <li>• Do all the lights come on?</li> </ul>
Parking brake	<ul style="list-style-type: none"> <li>• Moves smoothly?</li> <li>• Can hold the vehicle securely on an incline?</li> </ul>
Seat belts	<ul style="list-style-type: none"> <li>• Does the seat belt system operate smoothly?</li> <li>• Are the belts undamaged?</li> </ul>
Seats	<ul style="list-style-type: none"> <li>• Do the seat controls operate properly?</li> </ul>
Steering wheel	<ul style="list-style-type: none"> <li>• Moves smoothly?</li> <li>• Has correct free play?</li> <li>• No strange noises?</li> </ul>



## Vehicle exterior

Items	Check points
Door/trunk	<ul style="list-style-type: none"> <li>• Operate smoothly?</li> </ul>
Engine hood	<ul style="list-style-type: none"> <li>• The lock system works properly?</li> </ul>
Fluid leaks	<ul style="list-style-type: none"> <li>• Is there any leakage after parking?</li> </ul>
Tires	<ul style="list-style-type: none"> <li>• Inflation pressure is correct?</li> <li>• Tire surfaces not worn or damaged?</li> <li>• Tires rotated according to the maintenance schedule?</li> <li>• Wheel nuts are not loose?</li> </ul>

### CAUTION

#### ■ If the engine is running

Turn the engine off and ensure that there is adequate ventilation before performing maintenance checks.

## 4-2. Maintenance

### Emission inspection and maintenance (I/M) programs

Some states have vehicle emission inspection programs which include OBD (On Board Diagnostics) checks. The OBD system monitors the operation of the emission control system.

#### ■ If the malfunction indicator lamp comes on

The OBD system determines that a problem exists somewhere in the emission control system. Your vehicle may not pass the I/M test and may need to be repaired. Contact your Toyota dealer to service the vehicle.

#### ■ Your vehicle may not pass the I/M test:

- When the battery is disconnected or discharged

Readiness codes that are set during ordinary driving are erased.

Also, depending on your driving habits, the readiness codes may not be completely set.

- When the fuel tank cap is loose

The malfunction indicator lamp comes on as a temporary malfunction and your vehicle may not pass the I/M test.

#### ■ When the malfunction indicator lamp goes off after several driving trips

The error code in the OBD system will not be cleared unless the vehicle is driven 40 or more times.

#### ■ If your vehicle does not pass the I/M test

Contact your Toyota dealer to prepare the vehicle for re-testing.

### 4-3. Do-it-yourself maintenance

## Do-it-yourself service precautions

If you perform maintenance yourself, be sure to follow the correct procedures as given in these sections.

Items	Parts and tools
Battery condition (→P. 378)	<ul style="list-style-type: none"><li>• Warm water</li><li>• Baking soda</li><li>• Grease</li><li>• Conventional wrench (for terminal clamp bolts)</li></ul>
Brake fluid level (→P. 375)	<ul style="list-style-type: none"><li>• FMVSS No.116 DOT 3 or SAE J1703 brake fluid</li><li>• Rag or paper towel</li><li>• Funnel (used only for adding brake fluid)</li></ul>
Engine coolant level (→P. 373)	<p>• “Toyota Super Long Life Coolant” or similar high quality ethylene glycol based non-silicate, non-amine, non-nitrite and non-borate coolant with long-life hybrid organic acid technology.</p> <p>For the U.S.A.:</p> <p>• “Toyota Super Long Life Coolant” is pre-mixed with 50% coolant and 50% deionized water.</p> <p>For Canada:</p> <p>• “Toyota Super Long Life Coolant” is pre-mixed with 55% coolant and 45% deionized water.</p> <ul style="list-style-type: none"><li>• Funnel (used only for adding engine coolant)</li></ul>
Engine oil level (→P. 368)	<ul style="list-style-type: none"><li>• “Toyota Genuine Motor Oil” or equivalent</li><li>• Rag or paper towel, funnel (used only for adding oil)</li></ul>

Items	Parts and tools
Fuses (→P. 405)	Fuse with same amperage rating as original
Light bulbs (→P. 418)	Bulb with same number and wattage rating as original
Power steering fluid level (→P. 376)	<ul style="list-style-type: none"> <li>• Automatic transmission fluid DEXRON® II or III</li> <li>• Rag or paper towel</li> <li>• Funnel (used only for adding power steering fluid)</li> </ul>
Radiator and condenser (→P. 374)	—
Tire inflation pressure (→P. 392)	<ul style="list-style-type: none"> <li>• Tire pressure gauge</li> <li>• Compressed air source</li> </ul>
Washer fluid (→P. 381)	<ul style="list-style-type: none"> <li>• Water washer fluid containing antifreeze (for winter use)</li> <li>• Funnel</li> </ul>

 CAUTION

The engine compartment contains many mechanisms and fluids that may move suddenly, become hot, or become electrically energized. To avoid death or serious injury observe the following precautions.

■ **When working on the engine compartment**

- Keep hands, clothing, and tools away from the moving fan and engine drive belt.
- Be careful not to touch the engine, radiator, exhaust manifold, etc. right after driving as they may be hot. Oil and other fluids may also be hot.
- Do not leave anything that may burn easily, such as paper or rags, in the engine compartment.

 **CAUTION**

- Do not smoke, cause sparks or expose an open flame to fuel or the battery. Fuel and battery fumes are flammable.
- Be extremely cautious when working on the battery. It contains poisonous and corrosive sulfuric acid.
- Take care because brake fluid can harm your hands or eyes and damage painted surfaces.  
If fluid gets on your hands or in your eyes, flush the affected area with clean water immediately.  
If you still experience discomfort, see a doctor.

■ **When working near the electric cooling fans or radiator grille**

Vehicles with smart key system: Be sure the “ENGINE START STOP” switch is OFF. With the “ENGINE START STOP” switch in IGNITION ON mode, the electric cooling fans may automatically start to run if the air conditioning is on and/or the coolant temperature is high. (→P. 374)

Vehicles without smart key system: Be sure the engine switch is OFF. With the engine switch in the “ON” position, the electric cooling fans may automatically start to run if the air conditioning is on and/or the coolant temperature is high. (→P. 374)

■ **Safety glasses**

Wear safety glasses to prevent flying or falling material, fluid spray, etc. from getting in the eyes.

 **NOTICE**

■ **If you remove the air cleaner**

Driving with the air cleaner removed may cause excessive engine wear due to dirt in the air. Also, a backfire could cause a fire in the engine compartment.

## 4-3. Do-it-yourself maintenance

### Hood

Release the lock from the inside of the vehicle to open the hood.

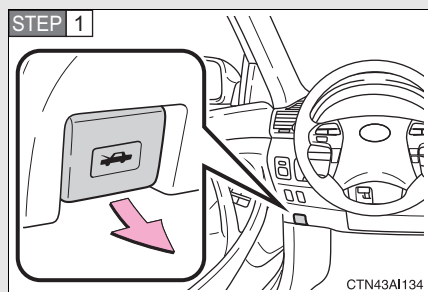

Pull the hood release lever.

The hood will pop up slightly.

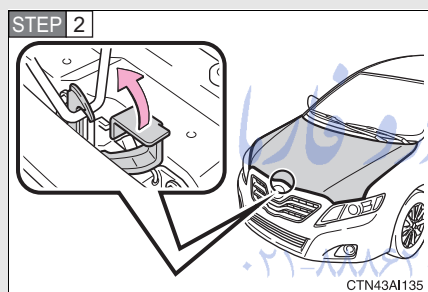

Lift the auxiliary catch lever and lift the hood.

#### CAUTION

#### ■ Pre-driving check

Check that the hood is fully closed and locked.

If the hood is not locked properly, it may open while the vehicle is in motion and cause an accident, which may result in death or serious injury.

## 4-3. Do-it-yourself maintenance

### Positioning a floor jack

When raising your vehicle with a floor jack, position the jack correctly. Improper placement may damage your vehicle or cause injury.

#### ■ Front

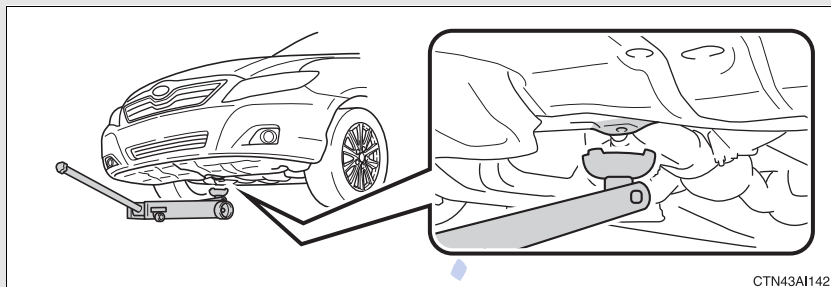

#### ■ Rear

##### ► Type A

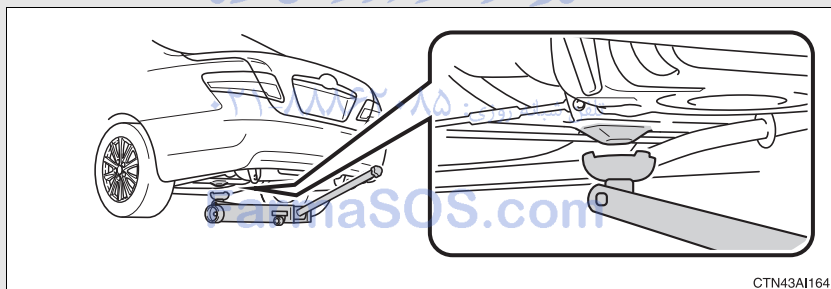

##### ► Type B

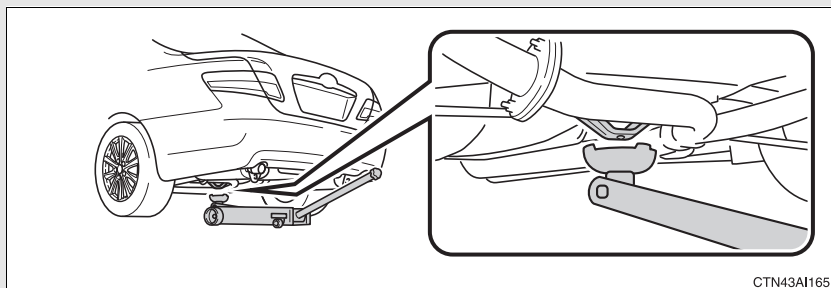

**! CAUTION**

**■ When raising your vehicle**

Make sure to observe the following to reduce the possibility of death or serious injury:

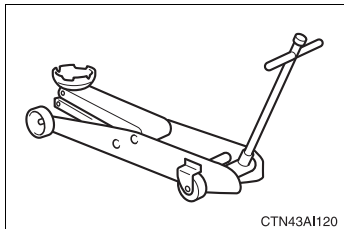

● Lift up the vehicle using a floor jack such as the one shown in the illustration.

- Do not use the jack that was supplied with your vehicle.
- Do not put any part of your body or get underneath the vehicle supported only by the floor jack.  
Always use automotive jack stands on a solid, level surface.
- Do not start the engine while the vehicle is supported by the floor jack.
- Stop the vehicle on level firm ground, firmly set the parking brake and put the shift lever in P (automatic transmission) or R (manual transmission).
- Make sure to set the floor jack properly at the jack point.  
Raising the vehicle with an improperly positioned floor jack will damage the vehicle and may cause the vehicle to fall off the floor jack.
- Do not raise the vehicle while someone is in the vehicle.
- When raising the vehicle, do not place any objects on top of or underneath the floor jack.



## 4-3. Do-it-yourself maintenance

### Engine compartment

#### ► 2.5 L 4-cylinder (2AR-FE) engine

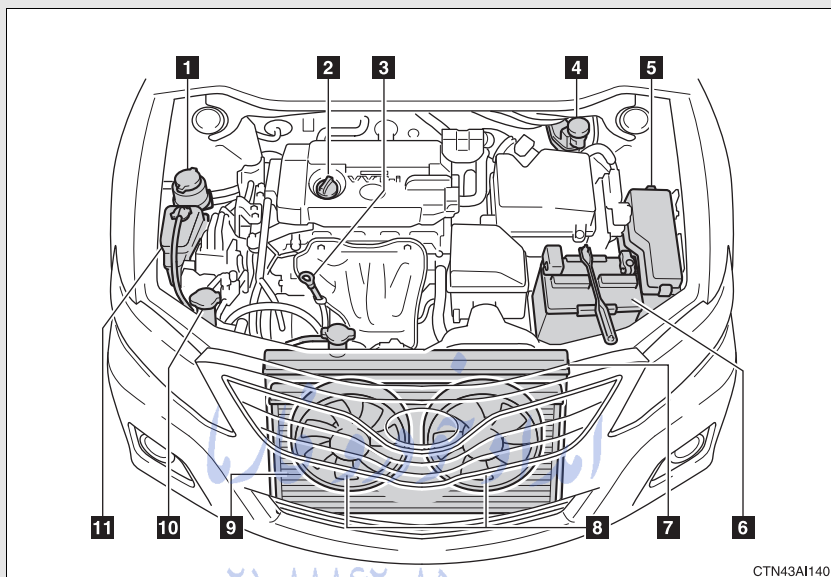

CTN43A1140

- |   |  |
|---|--|
| <b>1</b> Power steering fluid reservoir (→P. 376) | <b>5</b> Fuse box (→P. 405)                  |
| <b>2</b> Engine oil filler cap (→P. 370)          | <b>6</b> Battery (→P. 378)                   |
| <b>3</b> Engine oil level dipstick (→P. 368)      | <b>7</b> Radiator (→P. 374)                  |
| <b>4</b> Brake fluid reservoir (→P. 375)          | <b>8</b> Electric cooling fans               |
|   | <b>9</b> Condenser (→P. 374)                 |
|   | <b>10</b> Washer fluid tank (→P. 381)        |
|   | <b>11</b> Engine coolant reservoir (→P. 373) |

► 3.5 L V6 (2GR-FE) engine

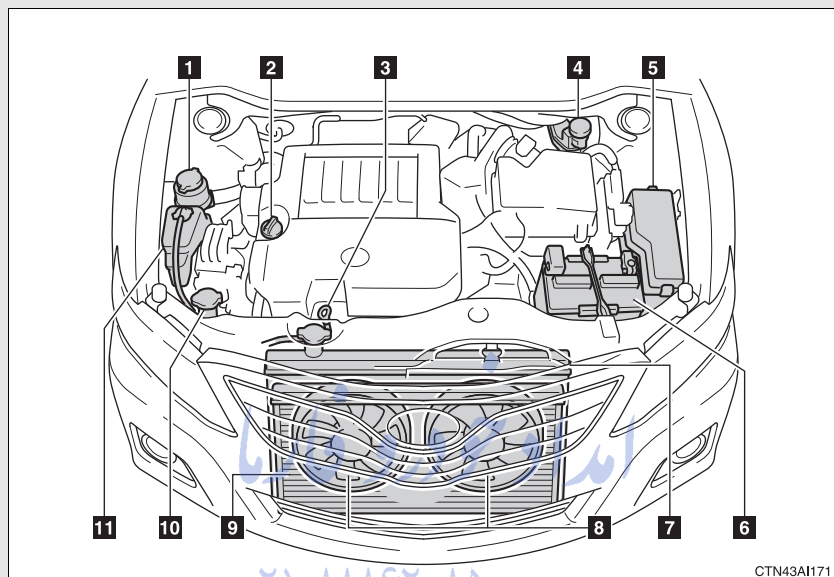

CTN43AI171

- |   |  |
|---|--|
| <b>1</b> Power steering fluid reservoir (→P. 376) | <b>5</b> Fuse box (→P. 405)                  |
| <b>2</b> Engine oil filler cap (→P. 370)          | <b>6</b> Battery (→P. 378)                   |
| <b>3</b> Engine oil level dipstick (→P. 368)      | <b>7</b> Radiator (→P. 374)                  |
| <b>4</b> Brake fluid reservoir (→P. 375)          | <b>8</b> Electric cooling fans               |
|   | <b>9</b> Condenser (→P. 374)                 |
|   | <b>10</b> Washer fluid tank (→P. 381)        |
|   | <b>11</b> Engine coolant reservoir (→P. 373) |

**Engine compartment cover (3.5 L V6 [2GR-FE] engine)**

■ **Removing the engine compartment cover**

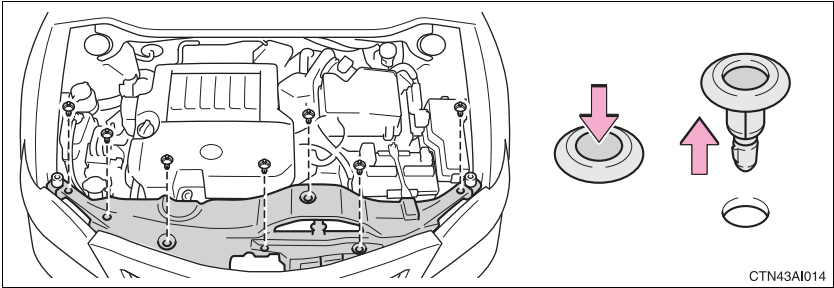

■ **Installing the clips**

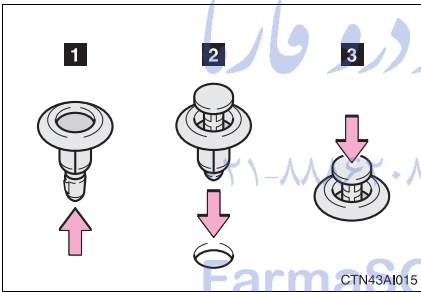

## Engine oil

With the engine at operating temperature and turned off, check the oil level on the dipstick.

### ■ Checking the engine oil

**STEP 1** Park the vehicle on level ground. After turning off the engine, wait more than five minutes for the oil to drain back into the bottom of the engine.

**STEP 2** Hold a rag under the end and pull the dipstick out.

#### ▶ 2.5 L 4-cylinder (2AR-FE) engine

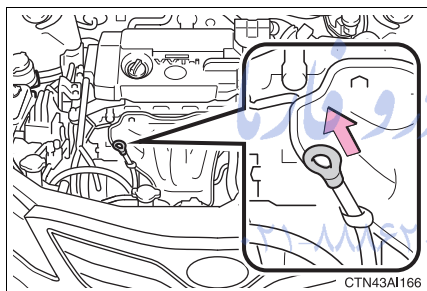

#### ▶ 3.5 L V6 (2GR-FE) engine

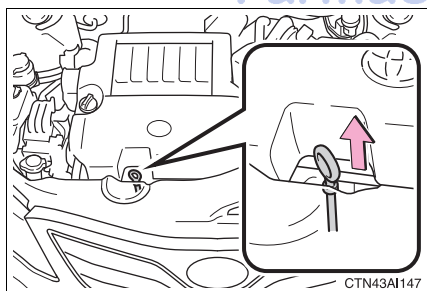

**STEP 3** Wipe the dipstick clean.

**STEP 4** Reinsert the dipstick fully.

**STEP 5** Holding a rag under the end, pull the dipstick out and check the oil level.

**STEP 6** Wipe the dipstick and reinsert it fully.

► 2.5 L 4-cylinder (2AR-FE) engine

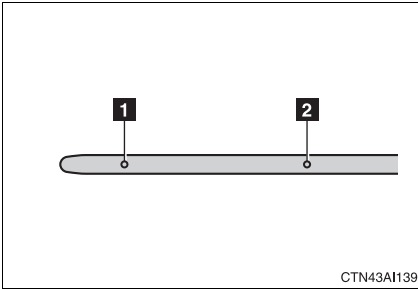

**1** Low

**2** Full

CTN43A1139

► 3.5 L V6 (2GR-FE) engine

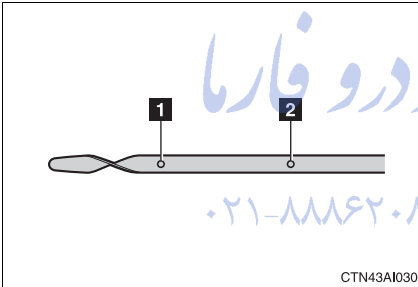

**1** Low

**2** Full

CTN43A1030

FarmaSOS.com

### ■ Adding engine oil

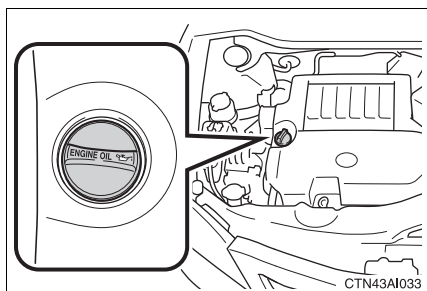

If the oil level is below or near the low level mark, add engine oil of the same type as already in the engine.

Make sure to check the oil type and prepare the items needed before adding oil.

Engine oil selection	→P. 485
Oil quantity (Low → Full)	1.6 qt. (1.5 L, 1.3 Imp. qt.)
Items	Clean funnel

**STEP 1** Remove the oil filler cap by turning it counterclockwise.

**STEP 2** Add engine oil slowly, checking the dipstick.

**STEP 3** Install the filler cap, turning it clockwise.

### ■ Engine oil consumption

- The amount of engine oil consumed depends on the oil viscosity, the quality of the oil and the way the vehicle is driven.
- More oil is consumed under driving conditions such as high speeds and frequent acceleration and deceleration.
- A new engine consumes more oil.
- When judging the amount of oil consumption, keep in mind that the oil may have become diluted, making it difficult to judge the true level accurately.
- Oil consumption: Max. 1.1 qt./600 miles, 0.9 Imp. qt./600 miles (1.0 L per 1000 km)
- If you consume more than 1.1 qt. (1.0 L, 0.9 Imp. qt.) every 600 miles (1000 km), contact your Toyota dealer.

### ■ After changing the engine oil (U.S.A. only)

To reset the oil change system, follow the procedure below:

**STEP 1** Turn the “ENGINE START STOP” switch or engine switch OFF with the trip meter A reading shown. (→P. 155) تلف

**STEP 2** While pressing the trip meter reset button (→P. 147), turn the “ENGINE START STOP” switch or engine switch ON.

▶ Without multi-information display

**STEP 3** Continue to press and hold the knob until the trip meter displays 000000.

▶ With multi-information display

**STEP 3** Continue to press and hold the knob until “COMPLETE” appears on the multi-information display.

 CAUTION

■ **Used engine oil**

- Used engine oil contains potentially harmful contaminants which may cause skin disorders such as inflammation or skin cancer, so care should be taken to avoid prolonged and repeated contact. To remove used engine oil from your skin, wash thoroughly with soap and water.
- Dispose of used oil and filters only in a safe and acceptable manner. Do not dispose of used oil and filters in household trash, in sewers or onto the ground. Call your Toyota dealer, service station or auto parts store for information concerning recycling or disposal.
- Do not leave used engine oil within the reach of children.

 NOTICE

■ **To prevent serious engine damage**

Check the oil level on a regular basis.

■ **When replacing the engine oil**

- Be careful not to spill engine oil on the vehicle components.
- Avoid overfilling, as the engine could be damaged.
- Check the oil level on the dipstick every time you refill the vehicle.
- Be sure the engine oil filler cap is properly tightened.



## Engine coolant

The coolant level is satisfactory if it is between the “F” and “L” lines on the reservoir when the engine is cold.

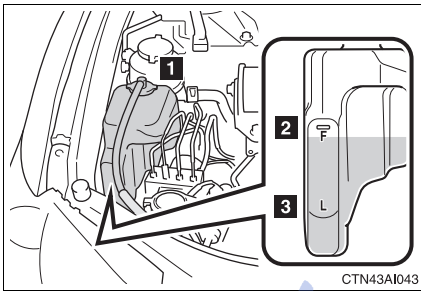

**1** Reservoir cap

**2** FULL

**3** LOW

If the level is on or below the “L” line, add coolant up to the “F” line.  
(→P. 475)

### ■ If the coolant level drops within a short time after replenishing

Visually check the radiator, hoses, engine coolant filler cap, radiator cap, drain cock and water pump.

If you cannot find a leak, have your Toyota dealer test the cap and check for leaks in the cooling system.

### ■ Coolant selection

Only use “Toyota Super Long Life Coolant” or similar high quality ethylene glycol based non-silicate, non-amine, non-nitrite, and non-borate coolant with long-life hybrid organic acid technology.

U.S.A.: “Toyota Super Long Life Coolant” is a mixture of 50% coolant and 50% deionized water. (Enabled: -31°F [-35°C])

Canada: “Toyota Super Long Life Coolant” is a mixture of 55% coolant and 45% deionized water. (Enabled: -44°F [-42°C])

For more details about engine coolant, contact your Toyota dealer.

## ⚠ CAUTION

### ■ When the engine is hot

Do not remove the coolant reservoir cap.

The cooling system may be under pressure and may spray hot coolant if the cap is removed, causing burns or other injuries.

 NOTICE

■ **When adding engine coolant**

Coolant is neither plain water nor straight antifreeze. The correct mixture of water and antifreeze must be used to provide proper lubrication, corrosion protection and cooling. Be sure to read the antifreeze or coolant label.

■ **If you spill coolant**

Be sure to wash it off with water to prevent damage to parts or paint.

**Radiator and condenser**

Check the radiator and condenser and remove any foreign objects. If any of the above parts are extremely dirty or you are not sure of their condition, have your vehicle checked by your Toyota dealer.

 CAUTION

■ **When the engine is hot**

Do not touch the radiator or condenser, as they may be hot and may cause burns.

تلفن شبانه روزی: ۰۸۵-۸۸۶۲۰۸۵  
FarmaSOS.com

## Brake fluid

### ■ Checking fluid level

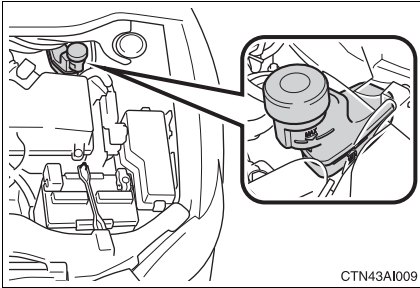

The brake fluid level should be between the “MAX” and “MIN” lines on the tank.

Make sure to check the fluid type and prepare the necessary items.

### ■ Adding fluid

Fluid type	FMVSS No.116 DOT 3 or SAE J1703 brake fluid
Items	Clean funnel

تلفن شبانه روزی: ۰۲۱-۸۸۶۲۰۸۵

### ■ Brake fluid can absorb moisture from the air

Excess moisture in the fluid can cause a dangerous loss of braking efficiency. Use only newly opened brake fluid.

## ⚠ CAUTION

### ■ When filling the reservoir

Take care because brake fluid can harm your hands or eyes and damage painted surfaces.

If fluid gets in your eyes, flush your eyes with clean water immediately.

If you still experience discomfort, see a doctor.

 NOTICE

■ If the fluid level is low or high

It is normal for the brake fluid level to go down slightly as the brake pads wear or when the fluid level in the accumulator is high.

If the reservoir needs frequent refilling, it may indicate a serious problem.

## Power steering fluid

### ■ Fluid level

The fluid level should be within the appropriate range.

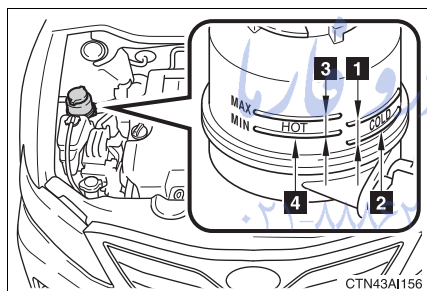

- 1 Full (when cold)
- 2 Add fluid (when cold)
- 3 Full (when hot)
- 4 Add fluid (when hot)

**Hot:** Vehicle has been driven around 50 mph (80 km/h) for 20 minutes, or slightly longer in cold temperatures. (Fluid temperature, 140°F - 175°F [60°C - 80°C])

**Cold:** Engine has not been run for about 5 hours. (Room temperature, 50°F - 85°F [10°C - 30°C])

### ■ Checking the fluid level

Make sure to check the fluid type and prepare the necessary items.

Fluid type	Automatic transmission fluid DEXRON® II or III
Items	Rag or paper towel and funnel (only for adding fluid)

**STEP 1** Clean all dirt off the reservoir.

**STEP 2** Remove the reservoir cap by turning it counterclockwise and wipe the dipstick clean.

**STEP 3** Reinstall the reservoir cap.

**STEP 4** Remove the reservoir cap again and look at the fluid level.

#### CAUTION

##### ■ Checking the fluid level

Take care, as the reservoir may be hot.

#### NOTICE

##### ■ When adding fluid

Avoid overfilling, or the power steering may be damaged.

##### ■ After replacing the reservoir cap

Check the steering box case, vane pump and hose connections for leaks or damage.

## Battery

Check the battery as follows.

### ■ Battery exterior

Make sure that the battery terminals are not corroded and that there are no loose connections, cracks, or loose clamps.

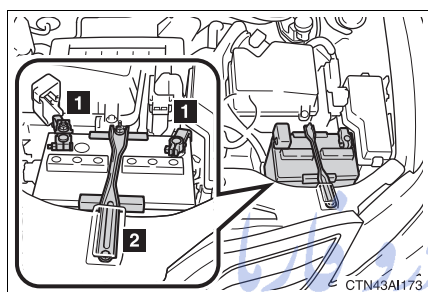

- 1 Terminals
- 2 Hold-down clamp

### ■ Checking battery fluid

Check the battery condition using the indicator color.

#### ► Type A

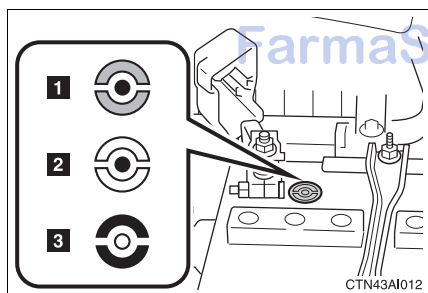

- 1 Blue: Good condition
- 2 White: Charging is necessary. Have the vehicle inspected by your Toyota dealer.
- 3 Red: Not working properly. Have the battery checked by your Toyota dealer.

## ► Type B

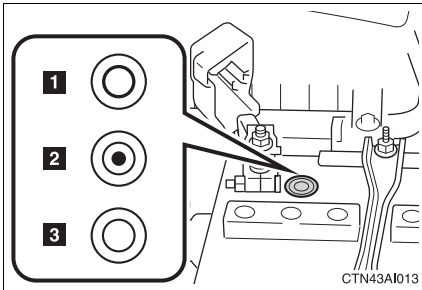

- 1 Green: Good condition
- 2 Dark: Charging is necessary. Have the vehicle inspected by your Toyota dealer.
- 3 Clear or light yellow: Not working properly. Have the battery checked by your Toyota dealer.

## ■ Before recharging

When recharging, the battery produces hydrogen gas which is flammable and explosive. Therefore, before recharging:

- If recharging with the battery installed on the vehicle, be sure to disconnect the ground cable.
- Make sure the power switch on the charger is off when connecting and disconnecting the charger cables to the battery.

## ■ After recharging/reconnecting the battery (vehicles with smart key system)

The engine may not start. Follow the procedure below to initialize the system.

- STEP 1** Shift the shift lever to P.
- STEP 2** Open and close any of the doors.
- STEP 3** Start the engine. (If the engine does not start first time, repeat the procedure.)

If the engine will not start even after multiple attempts at the above method, contact your Toyota dealer.

**! CAUTION**

**Chemicals in the battery**

A battery contains poisonous and corrosive sulfuric acid and may produce hydrogen gas which is flammable and explosive. To reduce the risk of death or serious injury, take the following precautions while working on or near the battery:

- Do not cause sparks by touching the battery terminals with tools.
- Do not smoke or light a match near the battery.
- Avoid contact with eyes, skin and clothes.
- Never inhale or swallow electrolyte.
- Wear protective safety glasses when working near the battery.
- Keep children away from the battery.

**Where to safely charge the battery**

Always charge the battery in an open area. Do not charge the battery in a garage or closed room where there is not sufficient ventilation.

**How to recharge the battery**

Only perform a slow charge (5 A or less). The battery may explode if charged at a quicker rate.

**Emergency measures regarding electrolyte**

- If electrolyte gets in your eyes  
Flush your eyes with clean water for at least 15 minutes and get immediate medical attention. If possible, continue to apply water with a sponge or cloth while traveling to the nearest medical facility.
- If electrolyte gets on your skin  
Wash the affected area thoroughly. If you feel pain or burning, get medical attention immediately.
- If electrolyte gets on your clothes  
It can soak through clothing on to your skin. Immediately take off the clothing and follow the procedure above if necessary.
- If you accidentally swallow electrolyte  
Drink a large quantity of water or milk. Get emergency medical attention immediately.



 NOTICE

■ **When recharging the battery**

Never recharge the battery while the engine is running. Also, be sure all accessories are turned off.

**Washer fluid**

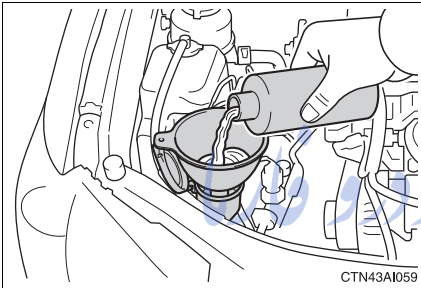

Add washer fluid in the following situations.

- Any washer does not work.
- The low washer fluid warning light comes on. (if equipped)
- The warning message appears on the multi-information display. (if equipped)

 CAUTION

■ **When refilling the washer fluid**

Do not refill the washer fluid when the engine is hot or running, as the washer fluid contains alcohol and may catch fire if spilled on the engine etc.

 NOTICE

■ **Do not use any fluid other than washer fluid**

Do not use soapy water or engine antifreeze instead of washer fluid. Doing so may cause streaking on the vehicle's painted surfaces.

■ **Diluting washer fluid**

Dilute washer fluid with water as necessary. Refer to the freezing temperatures listed on the washer fluid tank.

## 4-3. Do-it-yourself maintenance

### Tires

Replace or rotate tires in accordance with maintenance schedules and treadwear.

#### ■ Checking tires

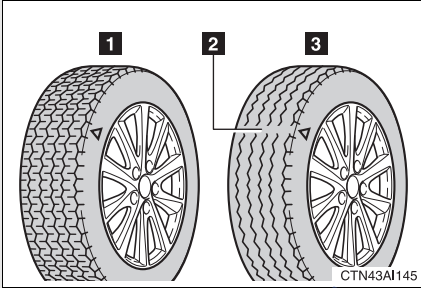

- 1 New tread
- 2 Treadwear indicator
- 3 Worn tread

The location of treadwear indicators is shown by the “TWI” or “△” marks, etc., molded on the sidewall of each tire.

Check spare tire condition and inflation pressure if not rotated.

#### ■ Tire rotation

##### ► Vehicles with a compact spare tire

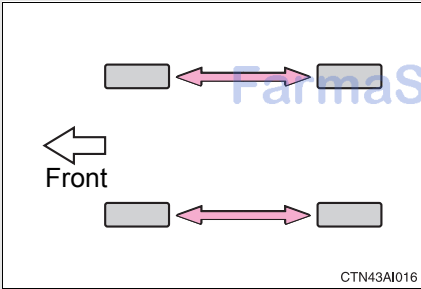

Rotate the tires in the order shown.

To equalize tire wear and extend tire life, Toyota recommends that tire rotation is carried out at the same interval as tire inspection.

► Vehicles with a full-size spare tire

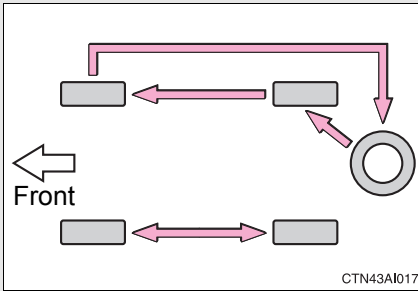

Rotate the tires in the order shown.

To equalize tire wear and extend tire life, Toyota recommends that tire rotation is carried out at the same interval as tire inspection.

■ The tire pressure warning system (U.S.A. only)

Your Toyota is equipped with a tire pressure warning system that uses tire pressure warning valves and transmitters to detect low tire inflation pressure before serious problems arise. (→P. 435)

Vehicles with compact spare tire: The compact spare tire is not equipped with the tire pressure warning valve and transmitters.

تلفن شبانه روزی: ۰۲۱-۸۸۶۲۰۸۵

FarmaSOS.com

### Installing tire pressure warning valves and transmitters

When replacing tires or wheels, tire pressure warning valves and transmitters must also be installed.

When new tire pressure warning valves and transmitters are installed, new tire pressure warning valve and transmitter ID codes must be registered in the tire pressure warning computer and the tire pressure warning system must be initialized. Have tire pressure warning valve and transmitter ID codes registered by your Toyota dealer. (→P. 385)

### Initializing the tire pressure warning system

- **The tire pressure warning system must be initialized when inflation the tire pressure is changed (such as when changing traveling speed or load weight.)**

When the tire pressure warning system is initialized, the current tire inflation pressure is set as the pressure benchmark.

#### ■ How to initialize the tire pressure warning system

**STEP 1** Park the vehicle in a safe place and turn the “ENGINE START STOP” switch or the engine switch OFF.

While the vehicle is moving, initialization is not performed.

**STEP 2** Adjust the tire inflation pressure to the specified cold tire inflation pressure level. (→P. 491)

Make sure to adjust the tire pressure to the specified cold tire inflation pressure level. The tire pressure warning system will operate based on this pressure level.

**STEP 3** Turn the “ENGINE START STOP” switch to IGNITION ON mode (vehicles with smart key system) or engine switch to the “ON” position (vehicles without smart key system).

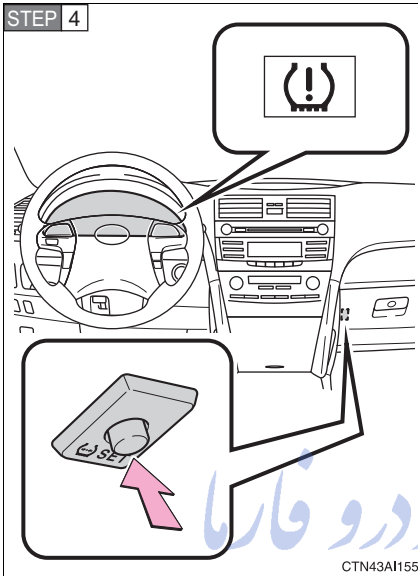

Push and hold the tire pressure warning reset switch until the tire pressure warning light blinks slowly 3 times.

**STEP 5** Vehicles with smart key system: Wait for a few minutes with the IGNITION ON mode, and then turn the “ENGINE START STOP” switch OFF.

Vehicles without smart key system: Wait for a few minutes with the engine switch “ON”, and then turn the engine switch to the “LOCK” position.

### Registering ID codes

The tire pressure warning valve and transmitter is equipped with a unique ID code. When replacing a tire pressure warning valve and transmitter, it is necessary to register the ID code of tire pressure warning valve and transmitter. Have the ID code registered by your Toyota dealer.

### ■ When to replace your vehicle's tires

Tires should be replaced if:

- You have tire damage such as cuts, splits, cracks deep enough to expose the fabric or bulges indicating internal damage
- A tire goes flat repeatedly or cannot be properly repaired due to the size or location of a cut or other damage

If you are not sure, consult with your Toyota dealer.

### ■ Replacing tires and wheels

If the ID code of the tire pressure warning valve and transmitter is not registered, the tire pressure warning system will not work properly. After driving for about 20 minutes, the tire pressure warning light comes on after blinking for 1 minute to indicate a system malfunction.

### ■ Tire life

Any tire over 6 years old must be checked by a qualified technician even if they have seldom or never been used or damage is not obvious.

### ■ If the tread wears down below 0.16 in. (4 mm) on snow tires

The effectiveness of snow tires is lost. تلفن شبانه روزی: ۰۲۱-۸۵۰۰۰۰۰۰

### ■ If you push the tire pressure warning reset switch accidentally

If initialization is performed, adjust the tire inflation pressure to the specified level and initialize the tire pressure warning system again. تلفن شبانه روزی: ۰۲۱-۸۵۰۰۰۰۰۰

### ■ When the initialization of the tire pressure warning system has failed

Initialization can be completed in a few minutes. However, in the following cases, the settings has not been recorded and the system will not operate properly. If repeated attempts to record tire inflation pressure settings are unsuccessful, have the vehicle inspected by your Toyota dealer.

- When operating the tire pressure warning reset switch, the tire pressure warning light does not flash 3 times.
- After carrying out the initialization procedure, the tire pressure warning light blinks for 1 minute then stays on after driving for about 20 minutes.

### ■ Routine tire inflation pressure checks

The tire pressure warning system does not replace routine tire inflation pressure checks. Make sure to check tire inflation pressure as part of your routine of daily vehicle checks.

### ■ Maximum load of tire

Check that the maximum load of the replacement tire is greater than 1/2 of the Gross Axle Weight Ratings (GAWR) of either the front axle or the rear axle, whichever is greater.

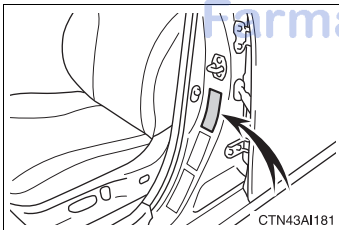

For the GAWR, see the Certification Label. For the maximum load of the tire, see the load limit at maximum cold tire inflation pressure mentioned on the sidewall of the tire. (→P. 498)

## ■ Tire types

### 1 Summer tires

Summer tires are high-speed performance tires best suited to highway driving under dry conditions. Since summer tires do not have the same traction performance as snow tires, summer tires are inadequate for driving on snow-covered or icy roads. For driving on snow-covered roads or icy roads, the use of snow tires is recommended. When installing snow tires, be sure to replace all four tires.

### 2 All season tires

All season tires are designed to provide better traction in snow and to be adequate for driving in most winter conditions, as well as for use year round. All season tires, however, do not have adequate traction performance compared with snow tires in heavy or loose snow. Also, all season tires fall short in acceleration and handling performance compared with summer tires in highway driving.

### 3 Snow tires

For driving on snow-covered roads or icy roads, we recommend using snow tires. If you need snow tires, select tires of the same size, construction and load capacity as the originally installed tires. Since your vehicle has radial tires as original equipment, make sure your snow tires also have radial construction. Do not install studded tires without first checking local regulations for possible restrictions. Snow tires should be installed on all wheels. (→P. 179)

## ■ Initializing the tire pressure warning system

Initialize the tire pressure warning system with the tire inflation pressure adjusted to the specified level.



### ■ Tire pressure warning system certification

FCC ID: PAXPMV107J

FCC ID: HYQ13BCX

IC ID: 3729A-PMV107J

IC ID: 1551A-13BCX

► For vehicles sold in the U.S.A.

This device complies with Part 15 of the FCC Rules. Operation is subject to the following two conditions: (1) This device may not cause harmful interference, and (2) this device must accept any interference received, including interference that may cause undesired operation.

#### FCC WARNING:

Changes or modifications not expressly approved by the party responsible for compliance could void the user's authority to operate the equipment.

► For vehicles sold in Canada

Operation is subject to the following two conditions: (1) this device may not cause interference, and (2) this device must accept any interference, including interference that may cause undesired operation of the device.

FarmaSOS.com

**! CAUTION**

**■ When inspecting or replacing tires**

Observe the following precautions to prevent accidents.

Failure to do so may cause damage to parts of the drive train, as well as dangerous handling characteristics, which may lead to an accident resulting in death or serious injury.

- Do not mix tires of different makes, models or tread patterns.  
Also, do not mix tires of remarkably different treadwear.
- Do not use tire sizes other than those recommended by Toyota.
- Do not mix differently constructed tires (radial, bias-belted or bias-ply tires).
- Do not mix summer, all season and winter tires.

**■ When initializing the tire pressure warning system**

Do not press the tire pressure warning reset switch without first adjusting the tire inflation pressure to the specified level. Otherwise, the tire pressure warning light may not come on even if the tire inflation pressure is low, or it may come on when the tire inflation pressure is actually normal.

FarmaSOS.com

 NOTICE

■ **Repairing or replacing tires, wheels and tire pressure warning valves and transmitters**

When removing or fitting the wheels, tires or the tire pressure warning valve and transmitter, contact your Toyota dealer as the tire pressure warning valve and transmitter may be damaged if not handled correctly.

■ **To avoid damaging the tire pressure warning valves and transmitters**

Do not use liquid sealants on flat tires.

■ **Driving on rough roads**

Take particular care when driving on roads with loose surfaces or pot-holes.

These conditions may cause losses in tire air pressure, reducing the cushioning ability of the tires. In addition driving on rough roads may cause damage to the tires themselves, as well as the vehicle's wheels and body.

■ **If tire inflation pressures become low while driving**

Do not continue driving, or your tires and/or wheels may be ruined.

FarmaSOS.com

# 4-3. Do-it-yourself maintenance

## Tire inflation pressure

### ■ Tire inflation pressure

The recommended cold tire inflation pressure and tire size is displayed on the tire and loading information label. (→P. 491)

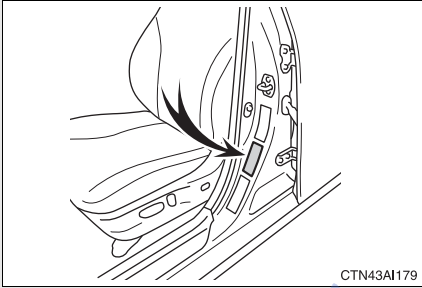

CTN43A1179

One of the following labels will be attached to the driver's side center pillar.

#### Type A

TIRE AND LOADING INFORMATION RENSEIGNEMENTS SUR LES PNEUS ET LE CHARGEMENT			
SEATING CAPACITY TOTAL X		NOMBRE DE PLACES ASSISES TOTAL X	
FRONT X, REAR X		AVANT X, ARRIERE X	
The combined weight of occupants and cargo should never exceed XXX kg or XXX lb. Le charge total des occupants et de chargement ne doit jamais être supérieur à XXX kg ou XXX lb.			
TIRE	SIZE	COLD TIRE PRESSURE	PNEUS DIMENSION PRESSION DES PNEUS A FROID
FRONT	XXXXXXXXXX	XXXXkPa, XXPSI	AVANT XXX/XXXXX XXXkPa, XXPSI
REAR	XXXXXXXXXX	XXXXkPa, XXPSI	ARRIERE XXX/XXXXX XXXkPa, XXPSI
SPARE	XXXXXXXXXX	XXXXkPa, XXPSI	SECOURS XXX/XXXXX XXXkPa, XXPSI
SEE OWNER'S MANUAL FOR ADDITIONAL INFORMATION		POUR DE PLUS AMPLES INFORMATIONS, VOIR LE MANUEL DU PROPRIETAIRE.	

#### Type B

TIRE AND LOADING INFORMATION RENSEIGNEMENTS SUR LES PNEUS ET LE CHARGEMENT DU VEHICULE			
SEATING CAPACITY TOTAL X		NOMBRE DE PLACES TOTAL X	
FRONT X, REAR X		AVANT X, ARRIERE X	
The combined weight of occupants and cargo should never exceed XXX kg or XXX lb. Le charge total des occupants et de chargement ne doit jamais dépasser XXX kg ou XXX lb.			
TIRE	ORIGINAL TIRE SIZE DIMENSION DES PNEUS D'ORIGINE	COLD TIRE INFLATION PRESSURE PRESSION DE GONFLAGE A FROID	SEE OWNER'S MANUAL FOR ADDITIONAL INFORMATION. CONSULTEZ LE GUIDE DU PROPRIETAIRE POUR DE PLUS AMPLES RENSEIGNEMENTS.
FRONT	XXXXXXXXXX	XXX kPa, XX PSI	XX XXXXXXX
REAR	XXXXXXXXXX	XXX kPa, XX PSI	
SPARE	XXXXXXXXXX	XXX kPa, XX PSI	

#### Type C

TIRE AND LOADING INFORMATION RENSEIGNEMENTS SUR LES PNEUS ET LE CHARGEMENT			
SEATING CAPACITY TOTAL X		NOMBRE DE PLACES TOTAL X	
FRONT X, REAR X		AVANT X, ARRIERE X	
The combined weight of occupants and cargo should never exceed XXX kg or XXX lb. Le charge total des occupants et de chargement ne doit jamais dépasser XXX kg ou XXX lb.			
TIRE	SIZE	COLD TIRE PRESSURE	PNEU DIMENSIONS PRESSION DES PNEUS A FROID
FRONT	XXXXXXXXXX	XXXXkPa, XXPSI	AVANT XXX/XXXXX XXXkPa, XXPSI
REAR	XXXXXXXXXX	XXXXkPa, XXPSI	ARRIERE XXX/XXXXX XXXkPa, XXPSI
SPARE	XXXXXXXXXX	XXXXkPa, XXPSI	DE SECOURS XXX/XXXXX XXXkPa, XXPSI
SEE OWNER'S MANUAL FOR ADDITIONAL INFORMATION		VOIR LE MANUEL DE L'USAGER POUR PLUS DE RENSEIGNEMENTS	

#### Type D

TIRE AND LOADING INFORMATION RENSEIGNEMENTS SUR LES PNEUS ET LE CHARGEMENT			
SEATING CAPACITY TOTAL X		NOMBRE DE PLACES TOTAL X	
FRONT X, REAR X		AVANT X, ARRIERE X	
The combined weight of occupants and cargo should never exceed XXX kg or XXX lb. Le charge total des occupants et de chargement ne doit jamais dépasser XXX kg ou XXX lb.			
TIRE	SIZE	COLD TIRE PRESSURE PRESSION DES PNEUS A FROID	SEE OWNER'S MANUAL FOR ADDITIONAL INFORMATION. VOIR LE MANUEL DE L'USAGER POUR PLUS DE RENSEIGNEMENTS.
FRONT	XXXXXXXXXX	XXX kPa, XX PSI	XX XXXXXXX
REAR	XXXXXXXXXX	XXX kPa, XX PSI	
SPARE	XXXXXXXXXX	XXX kPa, XX PSI	

CTN43A1183

### ■ Inspection and adjustment procedure

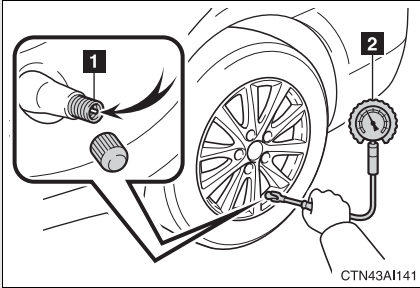

- 1 Tire valve
- 2 Tire pressure gauge

**STEP 1** Remove the tire valve cap.

**STEP 2** Press the tip of the tire pressure gauge onto the tire valve.

**STEP 3** Read the pressure using the graduations of the gauge.

**STEP 4** If the tire inflation pressure is not at the recommended level adjust the pressure.

If you add too much air, press the center of the valve to lower.

**STEP 5** After completing the tire inflation pressure measurement and adjustment, apply soapy water to the valve and check for leakage.

**STEP 6** Reinstall the tire valve cap.

### ■ Tire inflation pressure check interval

You should check tire inflation pressure every two weeks, or at least once a month.

Do not forget to check the spare.

### ■ Effects of incorrect tire inflation pressure

Driving with incorrect tire inflation pressure may result in the following:

- Reduced fuel efficiency
- Reduced driving comfort and tire life
- Reduced safety
- Damage to the drive train

If a tire needs frequent refilling, have it checked by your Toyota dealer.

### ■ Instructions for checking tire inflation pressure

When checking tire inflation pressure, observe the following:

- Check only when the tires are cold.

If your vehicle has been parked for at least 3 hours and has not been driven for more than 1 mile or 1.5 km, you will get an accurate cold tire inflation pressure reading.

- Always use a tire pressure gauge.

The appearance of the tire can be misleading. In addition, tire inflation pressures that are even just a few pounds off can degrade ride and handling.

- Do not bleed or reduce tire inflation pressure after driving. It is normal for the tire inflation pressure to be higher after driving.

- Never exceed the vehicle capacity weight.

Passengers and luggage weight should be placed so that the vehicle is balanced.

 CAUTION**■ Proper inflation is critical to save tire performance**

Keep your tires properly inflated. Otherwise, the following conditions may occur and result in an accident causing death or serious injury.

- Excessive wear
- Uneven wear
- Poor handling
- Possibility of blowouts resulting from overheated tires
- Poor sealing of the tire bead
- Wheel deformation and/or tire separation
- A greater possibility of tire damage from road hazards

 NOTICE**■ When inspecting and adjusting tire inflation pressure**

Be sure to reinstall the tire valve caps. تلفن شبانه روزی: ۰۲۰-۶۶۰۰۰۰۰۰

Without the valve caps, dirt or moisture could get into the valve and cause air leakage, which could result in an accident. If the caps have been lost, replace them as soon as possible.

## 4-3. Do-it-yourself maintenance

### Wheels

If a wheel is bent, cracked or heavily corroded, it should be replaced. Otherwise, the tire may separate from the wheel or cause loss of handling control.

#### ■ Wheel selection

When replacing wheels, care should be taken to ensure that they are equivalent to those removed in load capacity, diameter, rim width, and offset.

Replacement wheels are available at your Toyota dealer.

Toyota does not recommend using:

- Wheels of different sizes or types
- Used wheels
- Bent wheels that have been straightened

#### ■ Aluminum wheel precautions

- Use only Toyota wheel nuts and wrenches designed for use with your aluminum wheels.
- When rotating, repairing or changing your tires, check that the wheel nuts are still tight after driving 1000 miles (1600 km).
- Be careful not to damage the aluminum wheels when using tire chains.
- Use only Toyota genuine balance weights or equivalent and use a plastic or rubber hammer when balancing your wheels.

---

#### ■ When replacing wheels

The wheels of your Toyota are equipped with tire pressure warning valves and transmitters that allow the tire pressure warning system to provide advanced warning in the event of a loss in tire inflation pressure. Whenever wheels are replaced, the tire pressure warning valves and transmitters must be installed. (→P. 384)



 **CAUTION****■ When replacing wheels**

- Do not use wheels that are a different size from those recommended in the Owner's Manual, as this may result in loss of handling control.
- Never use an inner tube in a leaking wheel which is designed for a tubeless tire. Doing so may result in an accident, causing serious injury or death.

 **NOTICE****■ Replacing tire pressure warning valves and transmitters**

- Because tire repair or replacement may affect the tire pressure warning valves and transmitters, make sure to have tires serviced by your Toyota dealer or other qualified service shop. In addition, make sure to purchase your tire pressure warning valves and transmitters at your Toyota dealer.
- Ensure that only genuine Toyota wheels are used on your vehicle. Tire pressure warning valves and transmitters may not work properly with non-genuine wheels.

## 4-3. Do-it-yourself maintenance

### Air conditioning filter

The air conditioning filter must be cleaned or changed regularly to maintain air conditioning efficiency.

#### ■ Removal method

**STEP 1** Vehicles with smart key system: Turn the “ENGINE START STOP” switch OFF.

Vehicles without smart key system: Turn the engine switch OFF.

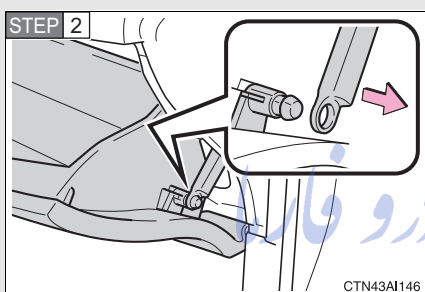

Open the glove box. Slide off the damper.

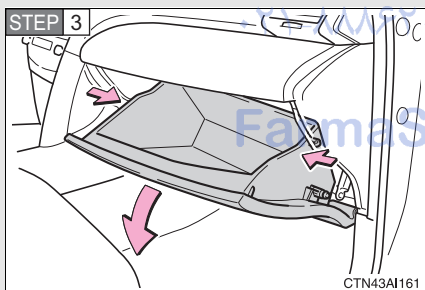

Apply pressure to the glove box as shown to disconnect the claws.

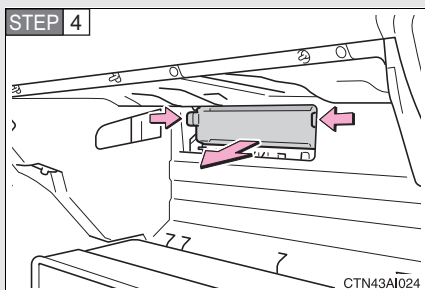

Remove the filter cover.

### ■ Cleaning method

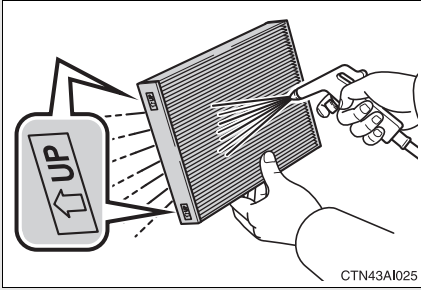

If the filter is dirty, clean by blowing compressed air through the filter from the downward side.

Hold the air gun 2 in. (5 cm) from the filter and blow for approximately 2 minutes at 72 psi (500 kPa, 5.0 kgf/cm<sup>2</sup> or bar).

If it is not available, have the filter cleaned by your Toyota dealer.

### ■ Replacement method

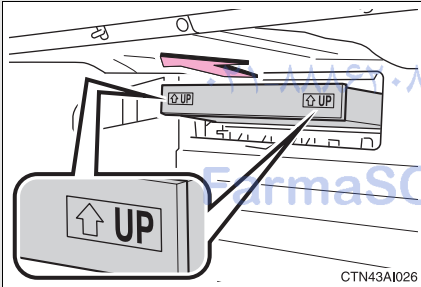

Remove the air conditioning filter and replace it with a new one.

The “↑UP” marks shown on the filter should be pointing up.

### ■ Checking interval

Inspect, clean and replace the air conditioning filter according to the maintenance schedule. In dusty areas or areas with heavy traffic flow, more frequent cleaning or early replacement may be required. (For scheduled maintenance information, please refer to the “Scheduled Maintenance Guide” or “Owner’s Manual Supplement”.)

### ■ If air flow from the vents decreases dramatically

The filter may be clogged. Check the filter and replace if necessary.

 NOTICE

■ **To prevent damage to the system**

- When using the air conditioning system, make sure that a filter is always installed.
- When cleaning the filter, do not clean the filter with water.

امداد خودرو فارما

تلفن شبانه روزی: ۰۲۱-۸۸۸۶۲۰۸۵

FarmaSOS.com

## 4-3. Do-it-yourself maintenance

### Key battery

Replace the battery with a new one if it is discharged.

■ You will need the following items:

- Flathead screwdriver (To prevent damage to the key, cover the tip of the screwdriver with rag.)
- Small Phillips-head screwdriver
- Lithium battery CR1632 (vehicles with smart key system), or CR2016 (vehicles without smart key system)

■ Replacing the battery

► Vehicles with smart key system

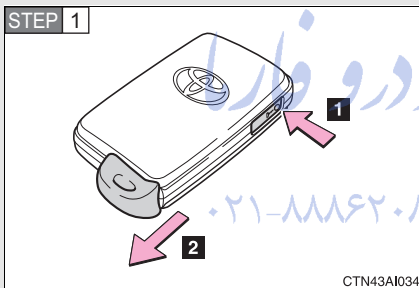

Take out the mechanical key.

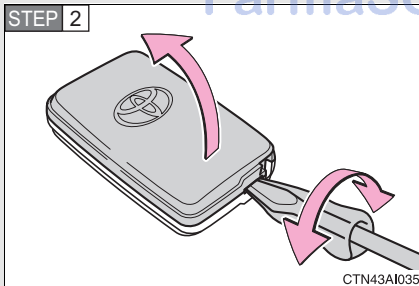

Remove the cover.

STEP 3

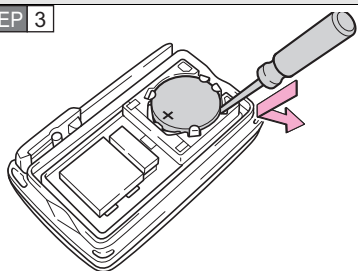

CTN43AI036

Remove the depleted battery.

Insert a new battery with the  
“+” terminal facing up.

► Vehicles without smart key system

STEP 1

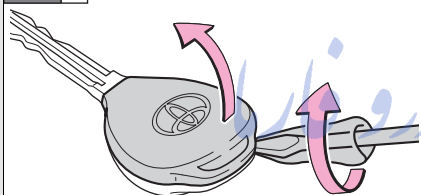

CTN43AI037

Remove the cover.

STEP 2

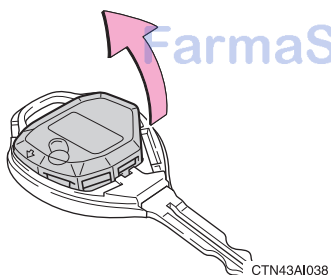

CTN43AI038

Remove the module.

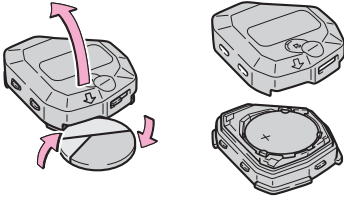
**STEP 3**

CTN43AI039

Open the case cover using a coin protected with tape etc. and remove the depleted battery.

Insert a new battery with the “+” terminal facing up.

### ■ If the key battery is discharged

The following symptoms may occur.

- The smart key system and wireless remote control will not function properly.
- The operational range is reduced.

### ■ Use a CR1632 (vehicles with smart key system), or CR2016 (vehicles without smart key system) lithium battery

- Batteries can be purchased at your Toyota dealer, jewelers, or camera stores.
- Replace only with the same or equivalent type recommended by your Toyota dealer.
- Dispose of used batteries according to the local laws.

### ⚠ CAUTION

#### ■ Removed battery and other parts

Keep away from children.

These parts are small and if swallowed by a child they can cause choking.

 NOTICE

■ **For normal operation after replacing the battery**

Observe the following precautions to prevent accidents.

- Always work with dry hands.  
Moisture may cause the battery to rust.
- Do not touch or move any other components inside the remote control.
- Do not bend either of the battery terminals.

امداد خودرو فارما

تلفن شبانه روزی: ۰۲۱-۸۸۸۶۲۰۸۵

FarmaSOS.com



## 4-3. Do-it-yourself maintenance

### Checking and replacing fuses

If any of the electrical components do not operate, a fuse may have blown. If this happens, check and replace the fuses as necessary.

**STEP 1** Vehicles with smart key system: Turn the “ENGINE START STOP” switch OFF.

Vehicles without smart key system: Turn the engine switch OFF.

**STEP 2** Open the fuse box cover.

#### ► Engine compartment

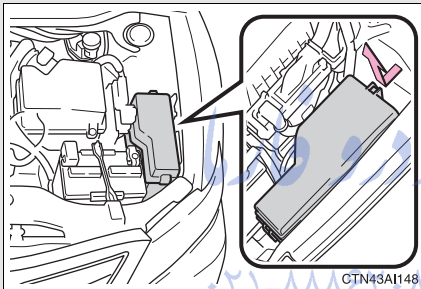

Push the tab in and lift the lid off.

#### ► Under the driver's side instrument panel

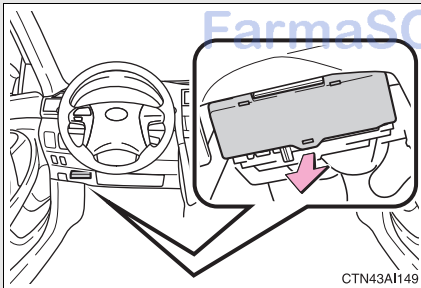

Remove the lid.

**STEP 3** After a system failure, see “Fuse layout and amperage ratings” (→P. 407) for details about which fuse to check.

**STEP 4**

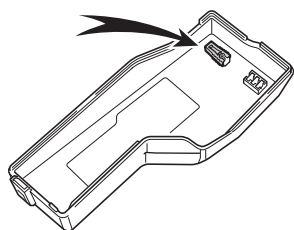

CTN43AI046

Take out the pullout tool.

Only type A fuse can be removed using the pullout tool.

**STEP 5** Check if the fuse has blown.

► Type A

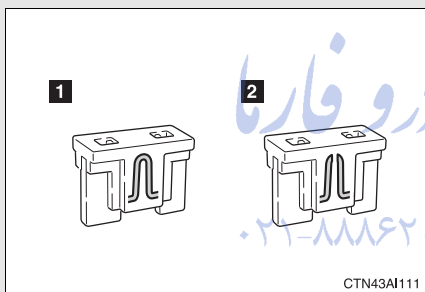

CTN43AI111

**1** Normal fuse

**2** Blown fuse

Replace it with one of an appropriate amperage rating. The amperage rating can be found on the fuse box lid.

تلفن شبانه روزی: ۰۲۲-۸۸۶۲۰۸۵

► Type B

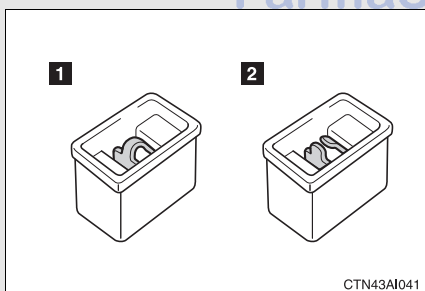

CTN43AI041

**1** Normal fuse

**2** Blown fuse

Replace it with one of an appropriate amperage rating. The amperage rating can be found on the fuse box lid.

► Type C

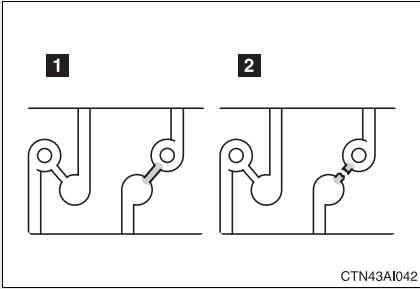

**1** Normal fuse

**2** Blown fuse

Contact your Toyota dealer.

**Fuse layout and amperage ratings**

■ Engine compartment (fuse box cover)



## ■ Engine compartment (fuse block)

### ▶ 2.5 L 4-cylinder (2AR-FE) engine

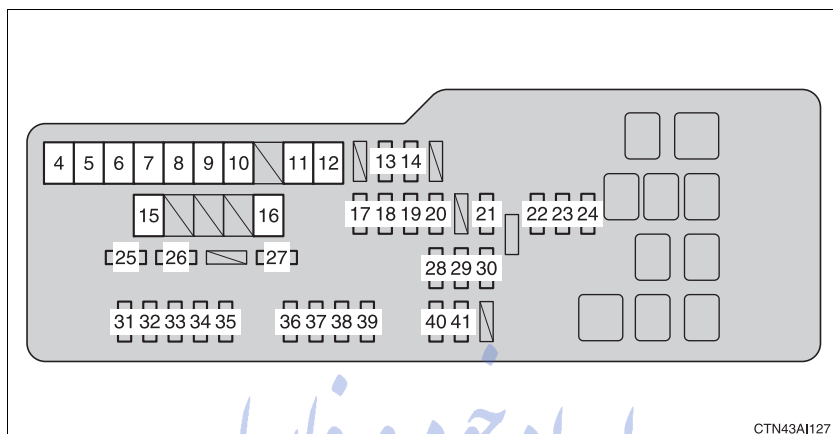

Fuse		Ampere	Circuit
1	SPARE	30 A	Spare fuse
2	SPARE	15 A	Spare fuse
3	SPARE	10 A	Spare fuse
4	MSB	30 A	No circuit
5	RDI FAN	40 A	Electric cooling fans
6	CDS FAN	40 A	Electric cooling fans
7	H-LP CLN	30 A	No circuit
8	RR PWR SEAT	30 A	No circuit
9	RR DEF	50 A	Rear window defogger, MIR HTR
10	ABS NO.2	30 A	Anti-lock brake system, vehicle stability control system, traction control system, brake assist system
11	ABS NO.1	50 A	Anti-lock brake system, vehicle stability control system, traction control system, brake assist system
12	HTR	50 A	Air conditioning system
13	FR DEF	15 A	No circuit

Fuse		Ampere	Circuit
14	RR FOG	10 A	No circuit
15	ST/AM2	30 A	Starting system, GAUGE NO.2, IGN, INJ
16	ALT	120 A	RR FOG, FR DEF, HTR, ABS NO.1, ABS NO.2, RR DEF, RR PWR SEAT, H-LP CLN, CDS FAN, RDI FAN, MSB, TAIL, PANEL, FR FOG, CIG, RADIO No.2, ECU-ACC, PWR OUTLET, GAUGE No.1, ECU IG No.1, ECU IG No.2, H-LP LVL, WASH, A/C No.2, S-HTR, WIP, P/SEAT, DOOR No.2, POWER, RR DOOR LH, RR DOOR RH, ECU-B No.2, OBD, FUEL OPN, PWR, STOP, S/ROOF, TI&TE, A/C, AM1
17	STR LOCK	20 A	Steering lock system
18	IG2	20 A	Multiport fuel injection system/ sequential multiport fuel injection system, starting system, GAUGE NO.2, IGN, INJ
19	HAZ	15 A	Turn signal lights, gauge and meters
20	ETCS	10 A	Multiport fuel injection system/ sequential multiport fuel injection system
21	EFI2	30 A	Multiport fuel injection system/ sequential multiport fuel injection system
22	MAYDAY/TEL	7.5 A	No circuit
23	ALT-S	7.5 A	Charging system
24	AM2	7.5 A	Main body ECU

Fuse		Ampere	Circuit
25	EFI MAIN	30 A	Multiport fuel injection system/ sequential multiport fuel injection system, EFI NO.2, EFI NO.3, main body ECU
26	AMP	25 A	Audio system
27	DOOR NO.1	25 A	Main body ECU
28	RADIO NO.1	15 A	Audio system, navigation system
29	ECU-B NO.1	10 A	Wireless remote control system, front passenger occupant classifi- cation system, main body ECU
30	DOME	10 A	Gauges and meters, trunk light, engine switch light, door courtesy lights, interior light, personal lights, clock, smart key system
31	H-LP(LH)	15 A	Left-hand headlight (high beam)
32	H-LP(RH)	15 A	Right-hand headlight (high beam)
33	H-LP(LL)	15 A	Left-hand headlight (low beam)
34	H-LP(RL)	15 A	Right-hand headlight (low beam)
35	HORN	10 A	Horns
36	EFI NO.1	10 A	Smart key system, multiport fuel injection system/sequential multi- port fuel injection system, main body ECU
37	MPX-B	10 A	Gauges and meters
38	A/F	20 A	No circuit
39	S-HORN	7.5 A	Horns
40	EFI NO.2	15 A	Multiport fuel injection system/ sequential multiport fuel injection system
41	EFI NO.3	10 A	Multiport fuel injection system/ sequential multiport fuel injection system

### ► 3.5 L V6 (2GR-FE) engine

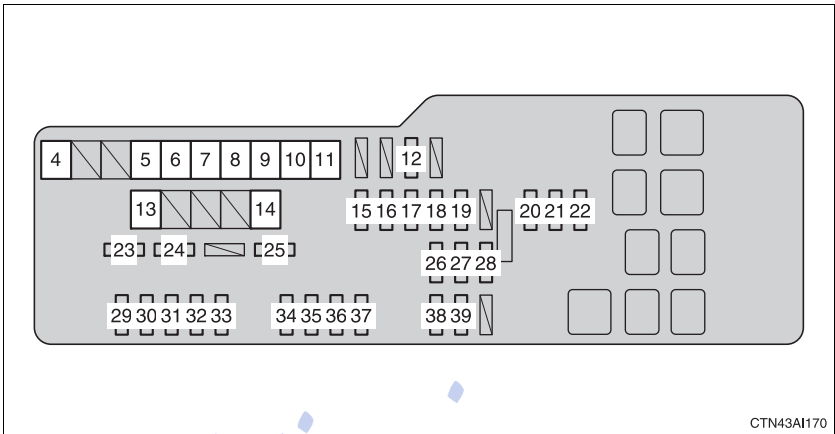

Fuse		Ampere	Circuit
1	SPARE	30 A	Spare fuse
2	SPARE	15 A	Spare fuse
3	SPARE	10 A	Spare fuse
4	MSB	30 A	No circuit
5	H-LP CLN	30 A	No circuit
6	RR PWR SEAT	30 A	No circuit
7	RR DEF	50 A	Rear window defogger, MIR HTR
8	ABS NO.2	30 A	Anti-lock brake system, vehicle stability control system, traction control system, brake assist system
9	FAN MAIN	50 A	Electric cooling fans
10	ABS NO.1	50 A	Anti-lock brake system, vehicle stability control system, traction control system, brake assist system
11	HTR	50 A	Air conditioning system
12	RR FOG	10 A	No circuit
13	ST/AM2	30 A	Starting system

Fuse		Ampere	Circuit
14	ALT	120 A	RR FOG, FR DEF, HTR, ABS NO.1, FAN MAIN, ABS NO.2, RR DEF, RR PWR SEAT, H- LP CLN, CDS FAN, RDI FAN, MSB, TAIL, PANEL, FR FOG, CIG, RADIO No.2, ECU-ACC, PWR OUTLET, GAUGE No.1, ECU IG No.1, ECU IG No.2, H-LP LVL, WASH, A/C No.2, S-HTR, WIP, P/SEAT, DOOR No.2, POWER, RR DOOR LH, RR DOOR RH, ECU-B No.2, OBD, FUEL OPN, PWR, STOP, S/ROOF, TI&TE, A/C, AM1
15	STR LOCK	20 A	Steering lock system
16	IG2	20 A	Multiport fuel injection system/ sequential multiport fuel injection system, starting system, GAUGE NO.2, IGN, INJ
17	HAZ	15 A	Turn signal lights, gauge and meters
18	ETCS	10 A	Multiport fuel injection system/ sequential multiport fuel injection system
19	E-ACM	10 A	No circuit
20	MAYDAY/TEL	7.5 A	No circuit
21	ALT-S	7.5 A	Charging system
22	AM2	7.5 A	Main body ECU
23	EFI MAIN	30 A	Multiport fuel injection system/ sequential multiport fuel injection system, EFI NO.2, EFI NO.3
24	AMP	25 A	Audio system
25	DOOR NO.1	25 A	Main body ECU
26	RADIO NO.1	15 A	Audio system, navigation system



Fuse		Ampere	Circuit
27	ECU-B NO.1	10 A	Wireless remote control system, front passenger occupant classification system, main body ECU
28	DOME	10 A	Gauges and meters, vanity lights, trunk light, engine switch light, door courtesy lights, interior light, personal lights, clock, smart key system
29	H-LP(LH)	15 A	Left-hand headlight (high beam)
30	H-LP(RH)	15 A	Right-hand headlight (high beam)
31	H-LP(LL)	15 A	Left-hand headlight (low beam)
32	H-LP(RL)	15 A	Right-hand headlight (low beam)
33	HORN	10 A	Horns
34	EFI NO.1	10 A	Smart key system, multiport fuel injection system/sequential multiport fuel injection system, main body ECU
35	MPX-B	10 A	Gauges and meters
36	A/F	20 A	Multiport fuel injection system/sequential multiport fuel injection system
37	S-HORN	7.5 A	Horns
38	EFI NO.2	15 A	Multiport fuel injection system/sequential multiport fuel injection system
39	EFI NO.3	10 A	Multiport fuel injection system/sequential multiport fuel injection system

### ■ Under the instrument panel

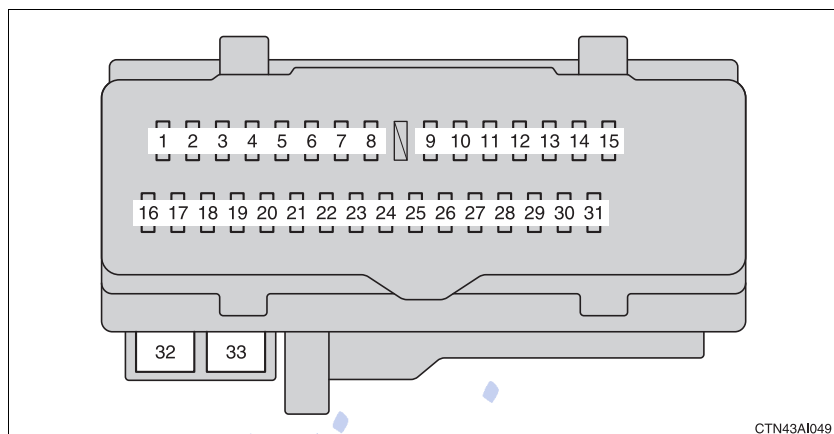

CTN43AI049

Fuse		Ampere	Circuit
1	RR DOOR RH	25 A	Rear right power window
2	RR DOOR LH	25 A	Rear left power window
3	FUEL OPN	7.5 A	No circuit, تلفن شبانه
4	FR FOG	15 A	Front fog lights
5	OBD	7.5 A	On-board diagnosis system
6	ECU-B NO.2	7.5 A	Power windows
7	STOP	10 A	High mounted stoplight, shift lock control system, multiport fuel injection system/sequential multiport fuel injection system, main body ECU, anti-lock brake system, vehicle stability control system, traction control system, brake assist system
8	TI&TE	30 A	No circuit
9	AM1	7.5 A	Multiport fuel injection system/sequential multiport fuel injection system
10	A/C	7.5 A	Air conditioning system

Fuse		Ampere	Circuit
11	PWR	25 A	Power windows
12	DOOR NO.2	25 A	Main body ECU
13	S/ROOF	30 A	Moon roof
14	TAIL	15 A	Front side marker/parking lights, stop/tail lights, rear side marker lights, license plate lights, back-up lights, front turn signal lights, main body ECU
15	PANEL	7.5 A	Navigation system, seat heaters, emergency flashers, air conditioning system, audio system, clock, glove box light, instrument panel lights, steering switches, vehicle stability control system, traction control system
16	ECU IG NO.1	10 A	Main body ECU, windshield wipers and washer, moon roof, tire pressure warning system, electric cooling fans, auto anti-glare inside rear view mirror, navigation system
17	ECU IG NO.2	7.5 A	Anti-lock brake system, vehicle stability control system, traction control system, brake assist system, shift lock control system, automatic transmission, cruise control system
18	A/C NO.2	10 A	Air conditioning system, rear window defogger
19	WASH	10 A	Windshield wipers and washer
20	S-HTR	20 A	Seat heaters
21	GAUGE NO.1	10 A	Emergency flashers, charging system, multiport fuel injection system/sequential multiport fuel injection system, back-up lights

Fuse		Ampere	Circuit
22	WIP	25 A	Windshield wipers and washer
23	H-LP LVL	7.5 A	No circuit
24	INJ	15 A	No circuit
25	IGN	10 A	Multiport fuel injection system/ sequential multiport fuel injection system, SRS airbag system, steering lock system, front passenger occupant classification system, smart key system, electronic throttle control system
26	GAUGE NO.2	7.5 A	Gauges and meters, multi-information display, clock
27	ECU-ACC	7.5 A	Clock, main body ECU, shift lock control system, outside rear view mirror, smart key system
28	CIG	20 A	No circuit
29	PWR OUTLET	20 A	Power outlet
30	RADIO NO.2	7.5 A	Audio system, navigation system
31	MIR HTR	10 A	Outside rear view mirror defoggers
32	POWER	30 A	Power windows
33	P/SEAT	30 A	Power seats

#### ■ After a fuse is replaced

- If the lights do not turn on even after the fuse has been replaced, a bulb may need replacing. (→P. 418)
- If the replaced fuse blows again, have the vehicle inspected by your Toyota dealer.

#### ■ If there is an overload in the circuits

The fuses are designed to blow before the entire wiring harness is damaged.

 **CAUTION**

■ **To prevent system breakdowns and vehicle fire**

Observe the following precautions.

Failing to do so may cause damage, and possibly a fire or injury.

- Never use a fuse of a higher amperage rating than indicated, or use any other object in place of a fuse.
- Always use a genuine Toyota fuse or equivalent.  
Never replace a fuse with a wire, even as a temporary fix.  
This can cause extensive damage or even fire.
- Do not modify the fuse or the fuse box.

 **NOTICE**

■ **Before replacing fuses**

Have the cause of electrical overload determined and repaired by your Toyota dealer, as soon as possible.

تلفن شماره روزی: ۰۲۱-۸۸۶۲۰۸۵

FarmaSOS.com

## 4-3. Do-it-yourself maintenance

### Light bulbs

You may replace the following bulbs yourself. The difficulty level of replacement varies depending on the bulb. If necessary bulb replacement seems difficult to perform, contact your Toyota dealer.

For more information about replacing other light bulbs, contact your Toyota dealer.

#### ■ Prepare a replacement light bulb.

Check the wattage of the light bulb being replaced. (→P. 494)

#### ■ Remove the engine compartment cover. (3.5 L V6 [2GR-FE] engine)

→P. 367

#### ■ Bulb locations

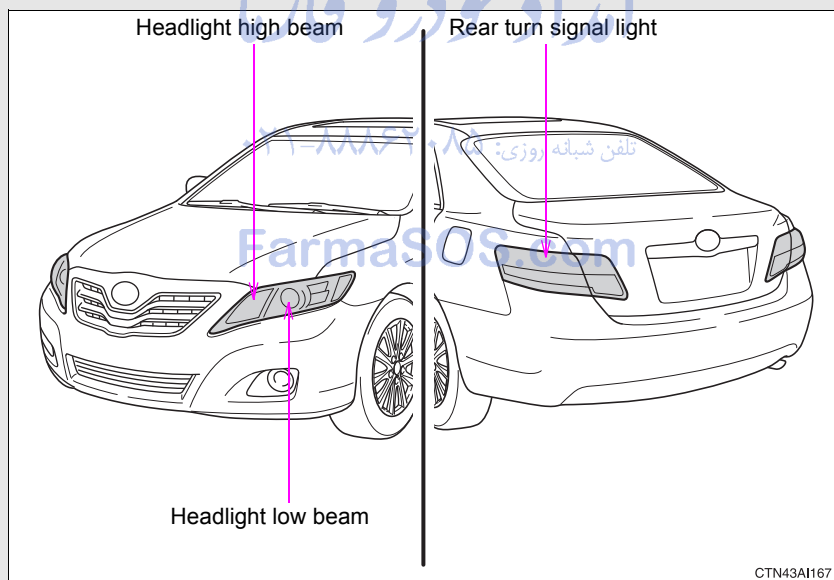

CTN43A1167

## Replacing light bulbs

### ■ Headlights

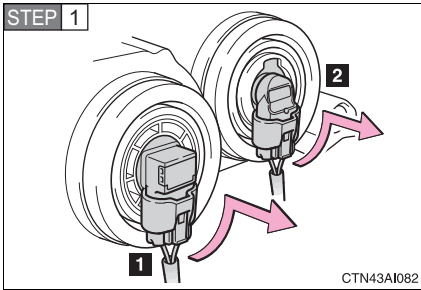

Turn the bulb base counterclockwise.

- 1 Headlight (low beam)
- 2 Headlight (high beam)

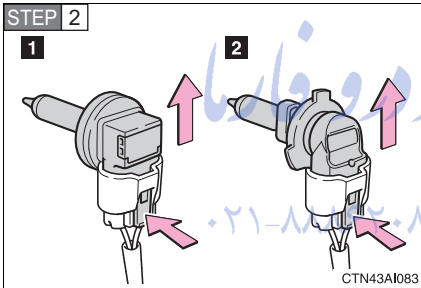

Unplug the connector while depressing the lock release.

- 1 Headlight (low beam)
- 2 Headlight (high beam)

### ■ Rear turn signal lights

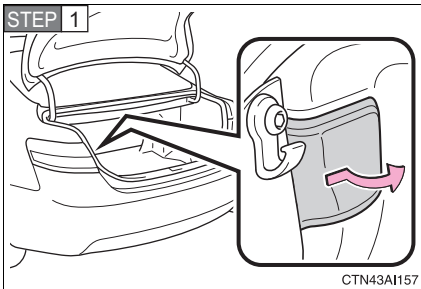

Open the trunk lid and remove the cover.

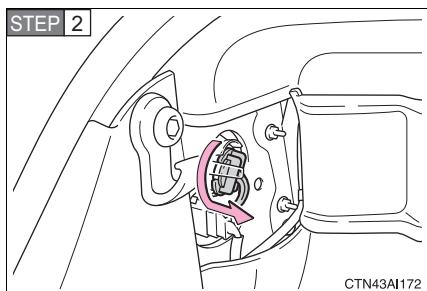

Turn the bulb bases counter-clockwise.

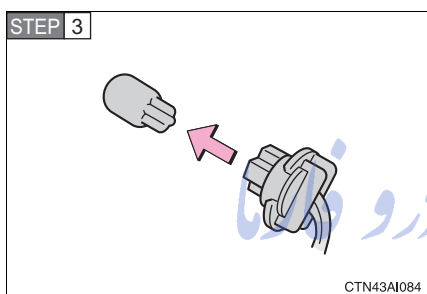

Remove the light bulb.

■ **Lights other than the above**

If any of the lights listed below has burnt out, have it replaced by your Toyota dealer.

- Front fog lights (if equipped)
- Front turn signal lights
- Stop/tail lights
- High mounted stoplight
- Front side marker/parking lights
- Back-up lights
- License plate lights
- Rear side marker lights



### ■ Condensation build-up on the inside of the lens

Contact your Toyota dealer for more information in the following situations. Temporary condensation build-up on the inside of the headlight lens does not indicate a malfunction.

- Large drops of water have built up on the inside of the lens.
- Water has built up inside the headlight.

### ■ LED stop/tail lights and high mounted stoplight

The stop/tail lights and high mounted stoplight consist of a number of LEDs. If any of the LEDs burn out, take your vehicle to your Toyota dealer to have the light replaced.

#### ▲ CAUTION

#### ■ Replacing light bulbs

- Turn off the headlights. Do not attempt to replace the bulb immediately after turning off the headlights.  
The bulbs become very hot and may cause burns.
- Do not touch the glass portion of the light bulb with bare hands. Hold the bulb by the plastic or metal portion.  
If the bulb is scratched or dropped it may blow out or crack.
- Fully install light bulbs and any parts used to secure them. Failing to do so may result in heat damage, fire, or water entering the headlight unit. This may damage the headlights or cause condensation to build up on the lens.

#### ■ To prevent damage or fire

Make sure bulbs are fully seated and locked.

امداد خودرو فارما

تلفن شبانه روزی: ۰۲۱-۸۸۸۶۲۰۸۵

**FarmaSOS.com**

## 5-1. Essential information

### Emergency flashers

Use the emergency flashers if the vehicle malfunctions or is involved in an accident.

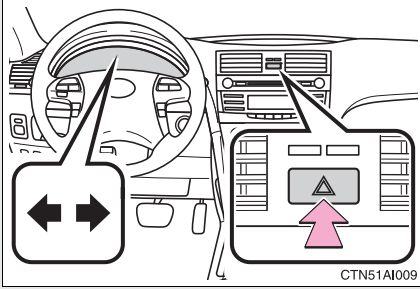

Press the switch to flash all the turn signal lights. To turn them off, press the switch once again.

#### NOTICE

#### ■ To prevent battery discharge

Do not leave the emergency flashers on longer than necessary when the engine is not running.

تلفن شبانه روزی: ۰۸۵-۸۸۶۲۰۲۱

FarmaSOS.com

## 5-1. Essential information

### If your vehicle needs to be towed

If towing is necessary, we recommend having your vehicle towed by your Toyota dealer or a commercial towing service, using a lift-type truck or a flat bed truck.

Use a safety chain system for all towing, and abide by all state/provincial and local laws.

If towing from the front, the vehicle's rear wheels and axles must be in good condition. (→P. 426)

If they are damaged, use a towing dolly or flat bed truck.

#### Before towing

The following may indicate a problem with your transmission. Contact your Toyota dealer before towing.

- The engine is running, but the vehicle will not move.
- The vehicle makes an abnormal sound.

تلفن شبانه روزی: ۰۲۱-۸۸۶۲۰۸۵

FarmaSOS.com

### Towing with a sling-type truck

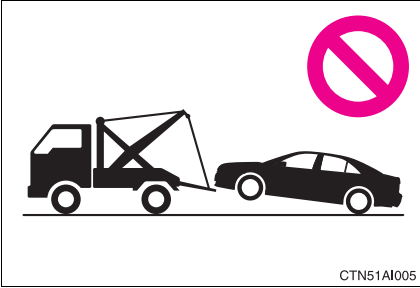

#### NOTICE

**■ To prevent body damage**

Do not tow with a sling-type truck, either from the front or rear.

### Towing with a wheel-lift type truck from the front

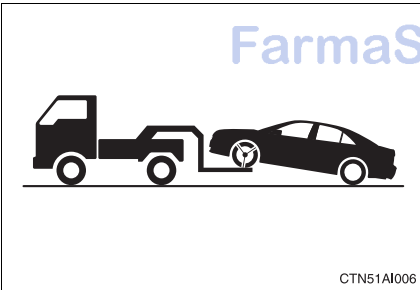

Release the parking brake.

#### NOTICE

**■ To prevent damaging the vehicle**

When raising the vehicle, ensure adequate ground clearance for towing at the opposite end of the raised vehicle. Without adequate clearance, the vehicle could be damaged while being towed.

### Towing with a wheel-lift type truck from the rear

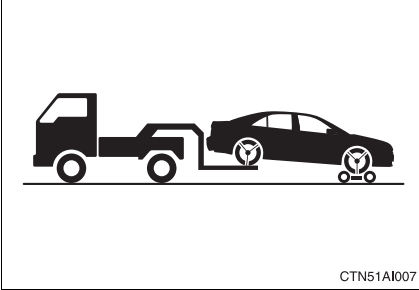

Automatic transmission: Use a towing dolly under the front wheels.

Manual transmissions: We recommend to use a towing dolly under the front wheels.

When not using a towing dolly, turn the engine switch to the "ACC" position and shift the shift lever to N.

#### NOTICE

##### ■ To prevent causing serious damage to the transmission (automatic transmission)

Never tow this vehicle from the rear with the front wheels on the ground.

##### ■ To prevent damaging the vehicle (manual transmission)

Do not tow the vehicle when the engine switch is in the "LOCK" position or key removed.

The steering lock mechanism is not strong enough to hold the front wheel straight.

### Using a flat bed truck

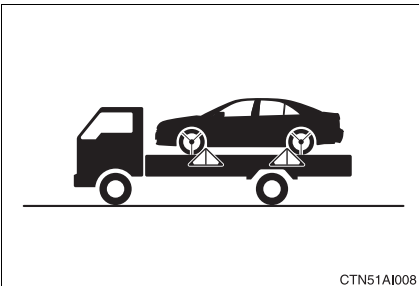

If you use chains or cables to tie down your vehicle, the angles shaded in black must be 45°.

Do not overly tighten the tie downs or the vehicle may be damaged.

## 5-1. Essential information

### If you think something is wrong

If you notice any of the following symptoms, your vehicle probably needs adjustment or repair. Contact your Toyota dealer as soon as possible.

#### ■ Visible symptoms

- Fluid leaks under the vehicle  
(Water dripping from the air conditioning after use is normal.)
- Flat-looking tires or uneven tire wear
- Engine coolant temperature gauge needle continually points higher than normal

#### ■ Audible symptoms

- Changes in exhaust sound
- Excessive tire squeal when cornering
- Strange noises related to the suspension system
- Pinging or other noises related to the engine

#### ■ Operational symptoms

- Engine missing, stumbling or running rough
- Appreciable loss of power
- Vehicle pulls heavily to one side when braking
- Vehicle pulls heavily to one side when driving on a level road
- Loss of brake effectiveness, spongy feeling, pedal almost touches the floor

## 5-1. Essential information

### Fuel pump shut off system

To minimize the risk of fuel leakage when the engine stalls or an air-bag inflates upon collision, the fuel pump shut off system stops supplying fuel to the engine.

Follow the procedure below to restart the engine after the system is activated.

► Vehicles with smart key system

**STEP 1** Turn the “ENGINE START STOP” switch OFF.

**STEP 2** Restart the engine.

► Vehicles without smart key system

**STEP 1** Turn the engine switch to the “ACC” or “LOCK” position.

**STEP 2** Restart the engine.



#### NOTICE

■ **Before starting the engine**

Inspect the ground under the vehicle.

If you find that fuel has leaked on to the ground, the fuel system has been damaged and is in need of repair. Do not restart the engine.



## 5-1. Essential information

### Event data recorder

Your vehicle has computers that monitor and control certain aspects of your vehicle. These computers assist in driving and maintaining optimal vehicle performance.

Besides storing data useful for troubleshooting, there is an event data recorder (EDR) that records data in a crash or a near car crash event.

#### In a crash or a near car crash event

The SRS airbag sensor assembly contains the EDR. In a crash or a near car crash event, this device may record some or all of the following information:

- Engine speed
- Whether the brake pedal was applied or not
- Vehicle speed
- To what extent the accelerator pedal was depressed
- Position of the transmission shift lever
- Whether the driver and front passenger wore seat belts or not
- Driver's seat position
- SRS airbag deployment data
- SRS airbag system diagnostic data
- Front passenger's occupant classification

The information above is intended to be used for the purpose of improving vehicle safety performance. Unlike general data recorders, the EDR does not record sound data such as conversation between passengers.

## Disclosure of the data

Toyota will not disclose the data recorded in an EDR to a third party except when:

- An agreement from the vehicle's owner (or the leasing company for a leased vehicle) is obtained
- Officially requested by the police or other authorities
- Used as a defense for Toyota in a law suit
- Ordered by a court law

However, if necessary Toyota will:

- Use the data for research on Toyota vehicle safety performance
- Disclose the data to a third party for research purposes without disclosing details of the vehicle owner, and only when it is deemed necessary
- Disclose summarized data cleared of vehicle identification information to a non-Toyota organization for research purposes

FarmaSOS.com



## 5-2. Steps to take in an emergency

### If a warning light turns on or a warning buzzer sounds...

Calmly perform the following actions if any of the warning lights turn on or flash. If a light turns on or flashes, but then turns off, this does not necessarily indicate a malfunction in the system.

**Stop the vehicle immediately. Continuing to drive the vehicle may be dangerous.**



The following warning indicates a possible problem in the brake system. Immediately stop the vehicle in a safe place and contact your Toyota dealer.

Warning light	Warning light/Details
 (U.S.A.)  (Canada)	<b>Brake system warning light (warning buzzer)*</b> <ul style="list-style-type: none"><li>• Low brake fluid</li><li>• Malfunction in the brake system</li></ul> This light also comes on when the parking brake is not released. If the light turns off after the parking brake is fully released the system is operating normally.

\*: Parking brake engaged warning buzzer: The buzzer sounds to indicate that the parking brake is still engaged (with the vehicle having reached a speed of 3 mph [5 km/h]).



### Stop the vehicle immediately.

The following warning indicates the possibility of damage to the vehicle that may lead to an accident. Immediately stop the vehicle in a safe place and contact your Toyota dealer.

Warning light	Warning light/Details
	<p><b>Charging system warning light</b> Indicates a malfunction in the vehicle's charging system.</p>
	<p><b>Low engine oil pressure warning light (vehicles without multi-information display)</b> Indicates that the engine oil pressure is too low.</p>

### Have the vehicle inspected immediately.

Failing to investigate the cause of the following warnings may lead to the system operating abnormally and possibly cause an accident. Have the vehicle inspected by your Toyota dealer immediately.

Warning light	Warning light/Details
 (U.S.A.)  (Canada)	<p><b>Malfunction indicator lamp</b> Indicates a malfunction in:</p> <ul style="list-style-type: none"> <li>• The electronic engine control system;</li> <li>• The electronic throttle control system; or</li> <li>• The electronic automatic transmission control system.</li> </ul>
	<p><b>SRS warning light</b> Indicates a malfunction in:</p> <ul style="list-style-type: none"> <li>• The SRS airbag system;</li> <li>• The front passenger occupant classification system; or</li> <li>• The seat belt pretensioner system.</li> </ul>

Warning light	Warning light/Details
<div style="border: 1px solid black; padding: 5px; display: inline-block; text-align: center;"> <b>ABS</b> </div> (U.S.A.)  <div style="border: 1px solid black; padding: 5px; display: inline-block; text-align: center;">  </div> (Canada)	<p><b>ABS warning light</b></p> <p>Indicates a malfunction in:</p> <ul style="list-style-type: none"> <li>• ABS; or</li> <li>• The brake assist system.</li> </ul>

■ **If the malfunction indicator lamp comes on while driving**

First check the following:

- Is the fuel tank empty?  
If it is, fill the fuel tank immediately.
- Is the fuel tank cap loose?  
If it is, tighten it securely.





The malfunction indicator lamp will go off after taking several driving trips.



If the malfunction indicator lamp does not go off even after several trips, contact your Toyota dealer as soon as possible.

FarmaSOS.com

**Follow the correction procedures.**

After taking the specified steps to correct the suspected problem, check that the warning light turns off.

Warning light	Warning light/Details	Correction procedure
	<b>Open door warning light (warning buzzer)*<sup>1</sup></b> Indicates that a door or the trunk is not fully closed.	Check that all doors and the trunk are closed.
	<b>Low fuel level warning light</b> Indicates that remaining fuel is about 2.8 gal. (10.5 L, 2.3 Imp. gal.) or less	Refuel the vehicle.
	<b>Driver's seat belt reminder light (warning buzzer)*<sup>2</sup></b> Warns the driver to fasten his/her seat belt.	Fasten the seat belt.
 (On the center panel)	<b>Front passenger's seat belt reminder light (warning buzzer)*<sup>2</sup></b> Warns the front passenger to fasten his or her seat belt.	Fasten the seat belt.
	<b>Low windshield washer fluid warning light (vehicles without multi-information display)</b> Low level of washer fluid	Fill the tank.

Warning light	Warning light/Details	Correction procedure
 (U.S.A. only)	<b>Engine oil replacement reminder light (vehicles without multi-information display)</b>	
	Illuminates for about 3 seconds and then flashes for about 15 seconds approximately 4500 miles (7200 km) after the engine oil is changed: Indicates that the engine oil is scheduled to be changed.	Check the engine oil, and change if necessary.
	Comes on and remains on if the distance driven exceeds 5000 miles (8000 km): Indicates that the engine oil should be changed.	Check and change the engine oil.
 (U.S.A. only)	<b>Tire pressure warning light</b>	تلفن شبانه روزی:
	When the light comes on: Low tire inflation pressure.	Adjust the tire inflation pressure.
	When the light comes on after blinking for 1 minute: Malfunction in the tire pressure warning system.	Have the system checked by your Toyota dealer.
	<b>Master warning light (vehicles with multi-information display)</b> A buzzer sounds and the warning light comes on and flashes to indicate that the master warning system has detected a malfunction.	→P. 444

## \*1: Open door warning buzzer:

The open door warning buzzer sounds to alert the driver that one or more of the doors or trunk is not fully closed (with the vehicle having reached a speed of 3 mph [5 km/h]).

## \*2: Driver's and front passenger's seat belt reminders:

The driver's and front passenger's seat belts reminder sound to alert the driver and front passenger that his or her seat belt is not fastened. The buzzer sounds intermittently for 10 seconds after the vehicle has reached a speed of at least 12 mph (20 km/h). Then, if the seat belt is still unfastened, the buzzer will sound at a different tone for 20 more seconds.

امداد خودرو فارما



تلفن شبانه روزی: ۰۲۱-۸۸۸۶۲۰۸۵

FarmaSOS.com



### Follow the correction procedures. (vehicles with smart key system)

After taking the specified steps to correct the suspected problem, check that the warning light turns off.

Interior buzzer	Exterior buzzer	Warning light	Warning light/Details	Correction procedure
Once	—	 (Comes on for 8 seconds.)	<b>Smart key system warning light</b> Indicates that the electronic key is not present when the “ENGINE START STOP” switch is pressed.	Confirm the location of the electronic key*.
Once	3 times		<b>Smart key system warning light</b> Indicates that a door other than the driver’s door has been opened and closed with the “ENGINE START STOP” switch in any mode other than OFF and the electronic key outside of the detection area.	Confirm the location of the electronic key.
Once	3 times		<b>Smart key system warning light</b> Indicates that the driver’s door has been opened or closed with the shift lever in P, the “ENGINE START STOP” switch in any mode other than OFF and the electronic key outside of the detection area.	Turn the “ENGINE START STOP” switch OFF or confirm the location of the electronic key.

Interior buzzer	Exterior buzzer	Warning light	Warning light/Details	Correction procedure
Continuous	Continuous		<p><b>Smart key system warning light</b></p> <p>Indicates that the driver's door has been opened or closed with the shift lever not in P, the "ENGINE START STOP" switch in any mode other than OFF and the electronic key outside of the detection area.</p>	<ul style="list-style-type: none"> <li>• Shift the shift lever to P.</li> <li>• Confirm the location of the electronic key.</li> </ul>

\*: If the engine does not start when the electronic key is inside the vehicle, the electronic key battery may be depleted or there may be difficulties receiving the signal from the key. (→P. 34)

#### ■ Key reminder buzzer (vehicles without smart key system)

The buzzer indicates that the key has not been removed with the engine off and the driver's door opened.

#### ■ Open moon roof reminder buzzer (if equipped)

The buzzer indicates that the moon roof is not fully closed with the engine off and the driver's door opened.

#### ■ Front passenger detection sensor and passenger seat belt reminder

- If luggage is placed on the front passenger seat, the front passenger detection sensor may cause the warning light to flash, even if a passenger is not sitting in the seat.
- If a cushion is placed on the seat, the sensor may not detect a passenger, and the warning light may not operate properly.

#### ■ Changing the engine oil (U.S.A. only)

Make sure to reset the oil change system. (→P. 371)

#### ■ When the tire pressure warning light comes on (U.S.A. only)

Check the tire inflation pressure and adjust to the appropriate level. Pushing the tire pressure warning reset switch does not turn off the tire pressure warning light.

■ **The tire pressure warning light may turn on due to natural causes**

The tire pressure warning light may turn on due to natural causes such as natural air leaks or tire inflation pressure changes caused by temperature. In this case, adjusting the tire inflation pressure will turn off the warning light (after a few minutes).

■ **When a tire is replaced with a spare tire**

▶ Vehicles with a compact spare tire

The compact spare tire is not equipped with the tire pressure warning valve and transmitter. If a tire goes flat, the tire pressure warning light will not turn off even though the flat tire is replaced with the spare tire. Replace the spare tire with the repaired tire and adjust the proper tire inflation pressure. The tire pressure warning light will turn off after a few minutes.

▶ Vehicles with a full-size spare tire

The spare tire is also equipped with the tire pressure warning valve and transmitter. The tire pressure warning light will turn on if the tire inflation pressure of the spare tire is low. If a tire goes flat, even though the flat tire is replaced with the spare tire, the tire pressure warning light does not turn off. Replace the spare tire with the repaired tire and adjust the proper tire inflation pressure. The tire pressure warning light will turn off after a few minutes.

■ **If the tire pressure warning system is inoperative**

The tire pressure warning system will be disabled in the following conditions:

(When the condition becomes normal, the system will work properly.)

- If tires not equipped with tire pressure warning valves and transmitters are used.
- If the ID code on the tire pressure warning valves and transmitters is not registered in the tire pressure warning computer.
- If the tire pressure warning select switch is set to a different tire setting.
- If the tire inflation pressure is 73 psi (500 kPa, 5.1 kgf/cm<sup>2</sup> or bar) or higher.

The tire pressure warning system may be disabled in the following conditions:

(When the condition becomes normal, the system will work properly.)

- If electronic devices or facilities using similar radio wave frequencies are nearby.
- If a radio set at similar frequencies is in use in the vehicle.
- If a window tint that affects the radio wave signals is installed
- If there is a lot of snow or ice on the vehicle, in particular around the wheels or wheel housings.
- If non-genuine Toyota wheels are used. (Even if you use Toyota wheels, the tire pressure warning system may not work properly with some types of tires.)
- If tire chains are used
- ▶ Vehicles without compact spare tire
  - If the spare tire is in a location subject to poor radio wave signal reception.
  - If a large metallic object which can interfere with signal reception is put in the luggage room.

■ **If the tire pressure warning light comes on after blinking for 1 minute frequently**

If the tire pressure warning light comes on after blinking for 1 minute frequently when the “ENGINE START STOP” switch or engine switch is turned ON, have it checked by your Toyota dealer.

■ **Customization that can be configured at Toyota dealer**

The vehicle speed linked seat belt reminder buzzer can be disabled. (Customizable features →P. 510) However, Toyota recommends that the seat belt reminder buzzer be operational to alert the driver and front passenger that the seat belts are not fastened.

 **CAUTION**

■ **If the tire pressure warning light comes on**

Be sure to observe the following precautions. Failure to do so could cause loss of vehicle control and result in death or serious injury.

- Stop your vehicle in a safe place as soon as possible. Adjust the tire inflation pressure immediately.

 **CAUTION**

- If the tire pressure warning light comes on even after tire inflation pressure adjustment, it is probable that you have a flat tire. Check the tires. If the tire is flat, change to the spare tire and have the flat tire repaired by the nearest Toyota dealer.
- Avoid abrupt maneuvering and braking. If the vehicle tires deteriorate, you could lose control of the steering wheel or the brakes.

■ **If a blowout or sudden air leakage should occur**

The tire pressure warning system may not activate immediately.

■ **Maintenance of the tires**

Each tire, including the spare (if provided), should be checked monthly when cold and inflated to the inflation pressure recommended by the vehicle manufacturer on the vehicle placard or tire inflation pressure label (tire and load information label). (If your vehicle has tires of a different size than the size indicated on the vehicle placard or tire inflation pressure label [tire and load information label], you should determine the proper tire inflation pressure for those tires.)

As an added safety feature, your vehicle has been equipped with a tire pressure monitoring system (TPMS-tire pressure warning system) that illuminates a low tire pressure telltale (tire pressure warning light) when one or more of your tires is significantly under-inflated. Accordingly, when the low tire pressure telltale (tire pressure warning light) illuminates, you should stop and check your tires as soon as possible, and inflate them to the proper pressure. Driving on a significantly under-inflated tire causes the tire to overheat and can lead to tire failure. Under-inflation also reduces fuel efficiency and tire tread life, and may affect the vehicle's handling and stopping ability.

Please note that the TPMS (tire pressure warning system) is not a substitute for proper tire maintenance, and it is the driver's responsibility to maintain correct tire pressure, even if under-inflation has not reached the level to trigger illumination of the TPMS low tire pressure telltale (tire pressure warning light).

 **CAUTION**

Your vehicle has also been equipped with a TPMS (tire pressure warning system) malfunction indicator to indicate when the system is not operating properly. The TPMS (tire pressure warning system) malfunction indicator is combined with the low tire pressure telltale (tire pressure warning light). When the system detects a malfunction, the telltale will flash for approximately one minute and then remain continuously illuminated. This sequence will continue upon subsequent vehicle start-ups as long as the malfunction exists. When the malfunction indicator is illuminated, the system may not be able to detect or signal low tire pressure as intended.

TPMS (tire pressure warning system) malfunctions may occur for a variety of reasons, including the installation of replacement or alternate tires or wheels on the vehicle that prevent the TPMS (tire pressure warning system) from functioning properly. Always check the TPMS (tire pressure warning system) malfunction telltale after replacing one or more tires or wheels on your vehicle to ensure that the replacement or alternate tires and wheels allow the TPMS (tire pressure warning system) to continue to function properly.

 **NOTICE**

FarmaSOS.com

■ **Precaution when installing a different tire**

When a tire of a different specification or maker is installed, the tire pressure warning system may not operate properly.

## 5-2. Steps to take in an emergency

### If a warning message is displayed (vehicles with multi-information display)

If a warning is shown on the multi-information display, stay calm and perform the following actions:

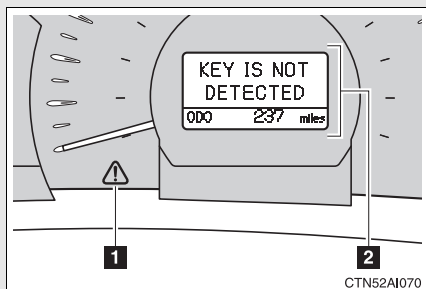

#### 1 Master warning light

The master warning light also comes on or flashes in order to indicate that a message is currently being displayed on the multi-information display.

#### 2 Multi-information display

If any of the warning lights turns on again after performing the following actions, contact your Toyota dealer.



امداد خودرو فارما

تلفن شبانه روزی: ۰۲۱-۸۸۶۲۰۸۵



FarmaSOS.com

### Stop the vehicle immediately.

- The following warning indicates the possibility of damage to the vehicle that may lead to an accident. Immediately stop the vehicle in a safe place and contact your Toyota dealer.

Warning message	Details
 <p>LOW ENGINE OIL PRESSURE</p> 	<p><b>Indicates an abnormal engine oil pressure.</b> A buzzer also sounds. The warning light may turn on if the engine oil pressure is too low.</p>



- The following warning indicates the possibility of damage to the vehicle that may lead to an accident. Immediately stop the vehicle in a safe place and allow the engine to cool.

Warning message	Details
 <p>WATER TEMP</p> 	<p><b>Indicates that the engine coolant temperature is too high.</b> A buzzer also sounds.</p>



**Have the vehicle inspected immediately.**

Failing to investigate the cause of the following warnings may lead to the system operating abnormally and possibly cause an accident. Have the vehicle inspected by your Toyota dealer immediately.



Warning message	Details
  (vehicles with smart key system)	<p><b>Indicates a malfunction in the steering lock system.</b></p> <p>A buzzer also sounds.</p>

تلفن شبانه روزی: ۰۲۱-۸۸۶۲۰۸۵



**FarmaSOS.com**



**Follow the correction procedures.**

After taking the specified steps to correct the suspected problem, check that the warning light turns off.

Warning message	Details	Correction procedure
	<p><b>Indicates that one or more of the doors is not fully closed.</b></p> <p>A buzzer sounds to indicate that one or more of the doors is not fully closed (with the vehicle having reached a speed of 3 mph [5 km/h]).</p>	<p>Make sure that all of the doors are closed.</p>
	<p><b>Indicates that the hood is not fully closed.</b></p> <p>A buzzer sounds to indicate that hood is not fully closed (with the vehicle having reached a speed of 3 mph [5 km/h]).</p>	<p>Close the hood.</p>

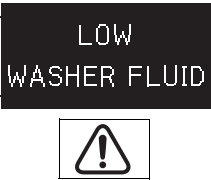
## 5-2. Steps to take in an emergency

Warning message	Details	Correction procedure
	<p><b>Indicates that the trunk is not fully closed.</b></p> <p>A buzzer sounds to indicate that the trunk is not fully closed (with the vehicle having reached a speed of 3 mph [5 km/h]).</p>	<p>Close the trunk.</p>
	<p><b>Indicates that the moon roof is not fully closed (with the “ENGINE START STOP” switch OFF [vehicles with smart key system] or the engine switch OFF [vehicles without smart key system], and the driver’s door open).</b></p> <p>A buzzer also sounds.</p>	<p>Close the moon roof.</p>
	<p><b>Indicates that the parking brake is still engaged with the vehicle having reached a speed of more than 3 mph (5 km/h).</b></p> <p>A buzzer also sounds.</p>	<p>Release the parking brake.</p>
	<p><b>Indicates that the washer fluid level is low.</b></p> <p>A buzzer also sounds.</p>	<p>Add washer fluid.</p>





Warning message	Details	Correction procedure
 <p>(U.S.A. only)</p>	<p><b>Indicates that the engine oil is scheduled to be changed.</b> A buzzer also sounds.</p> <p><b>Comes on approximately 4500 miles (7200 km) after the engine oil is changed. (The indicator will not work properly unless the oil maintenance data has been reset).</b></p>	<p>Check the engine oil, and change if necessary.</p>
 <p>(U.S.A. only)</p>	<p><b>Indicates that the engine oil should be changed.</b> A buzzer also sounds.</p> <p><b>Comes on approximately 5000 miles (8000 km) after the engine oil is changed (and the oil maintenance data has been reset).</b></p>	<p>Check and change the engine oil.</p>



### ■ Changing the engine oil (U.S.A. only)

Make sure to reset the oil change system. (→P. 371)

**Follow the correction procedures (vehicles with smart key system).**

After taking the specified steps to correct the suspected problem, check that the warning light turns off.

Interior buzzer	Exterior buzzer	Warning message	Details	Correction procedure
Once	—	 <p>(Comes on for 8 seconds)</p> 	Indicates that the electronic key is not present when the “ENGINE START STOP” switch is pressed.	Confirm the location of the electronic key.
Once	3 times	 	Indicates that a door other than the driver’s door has been opened and closed with the “ENGINE START STOP” switch in any mode other than OFF and the electronic key outside of the detection area.	Confirm the location of the electronic key.

Interior buzzer	Exterior buzzer	Warning message	Details	Correction procedure
Once	3 times	<p>KEY IS NOT DETECTED</p> 	Indicates that the driver's door has been opened and closed with the shift lever in P, the "ENGINE START STOP" switch in any mode other than OFF and the electronic key outside of the detection area.	Turn the "ENGINE START STOP" switch OFF or confirm the location of the electronic key.
Continuous	Continuous	<p>KEY IS NOT DETECTED</p> <p>SHIFT TO P RANGE</p> <p>(Displayed alternately)</p> 	Indicates that the driver's door has been opened and closed (with the shift lever not in P, the "ENGINE START STOP" switch in any mode other than OFF and the electronic key outside of the detection area).	<ul style="list-style-type: none"> <li>• Shift the shift lever to P.</li> <li>• Confirm the location of the electronic key.</li> </ul>
Once	—	<p>LOW KEY BATTERY</p> 	Indicates that the key battery is low.	Replace the battery. (→P. 401)

## 5-2. Steps to take in an emergency

Interior buzzer	Exterior buzzer	Warning message	Details	Correction procedure
Once	—	WHEN STARTING THE ENGINE DEPRESS THE BRAKE PEDAL	Indicates that a door has been opened or closed and the “ENGINE START STOP” switch has been turned twice to ACCESSORY mode from OFF.	Press the “ENGINE START STOP” switch while depressing the brake pedal.
Once	—	DEPRESS THE BRAKE PEDAL, AND TOUCH THE ENGINE SWITCH WITH THE KEY	Indicates that the electronic key does not operate properly.	→P. 470
Once	—	TO START, DEPRESS THE BRAKE PEDAL, AND PUSH THE ENGINE SWITCH		

FarmaSOS.com

Interior buzzer	Exterior buzzer	Warning message	Details	Correction procedure
Once	—	 <p>S/T IS NOT UNLOCKED</p>	Indicates that the steering lock has not released within 3 seconds of pressing the “ENGINE START STOP” switch.	Press the “ENGINE START STOP” switch again while turning the steering wheel with the brake pedal depressed.

امداد خودرو فارما

تلفن شبانه روزی: ۰۲۱-۸۸۶۲۰۸۵

FarmaSOS.com



## 5-2. Steps to take in an emergency If you have a flat tire

**Remove the flat tire and replace it with the spare provided.**

### ■ Before jacking up the vehicle

- Stop the vehicle on a hard, flat surface.
- Set the parking brake.
- Shift the shift lever to P (automatic transmission) or R (manual transmission).
- Stop the engine.
- Turn on the emergency flashers.

### ■ Location of the spare tire, jack and tools

#### ▶ Vehicles with a compact spare tire

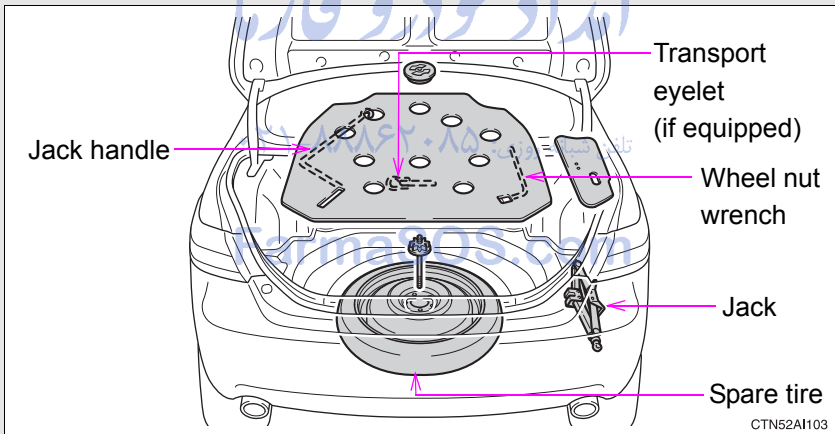

► Vehicles with a full-size spare tire

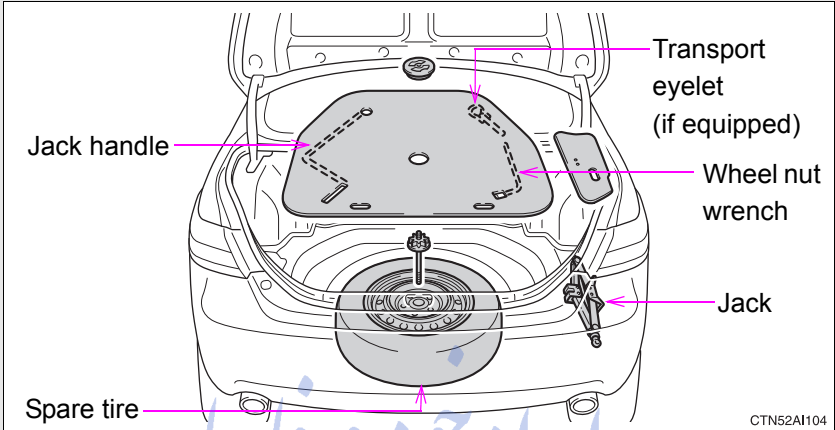

**Taking out the jack**

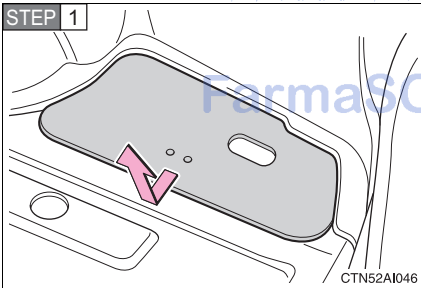

Remove the jack cover.

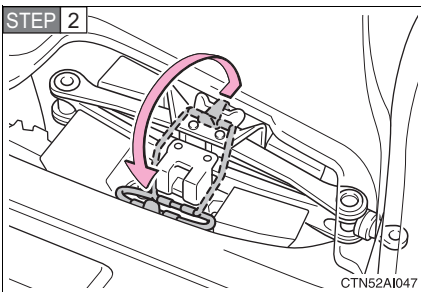

Remove the hook.

## Taking out the spare tire

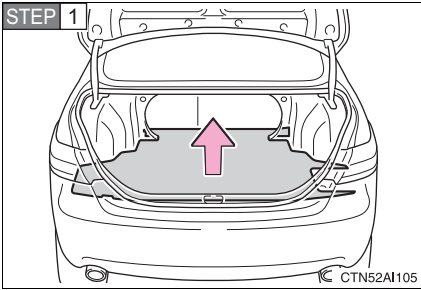

Remove the luggage floor cover.

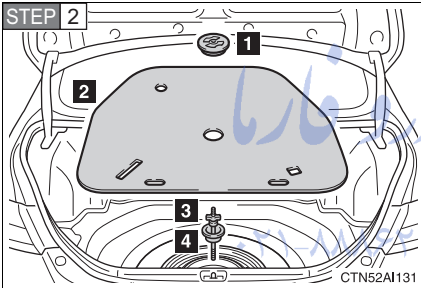

- 1 Loosen the nut and remove it.
- 2 Remove the spare tire cover.
- 3 Loosen the bolt and remove it.
- 4 Remove the spacer (with aluminum wheels).

تلفن شبانه روزی: ۸۵

FarmaSOS.com

**Replacing a flat tire**

**STEP 1**

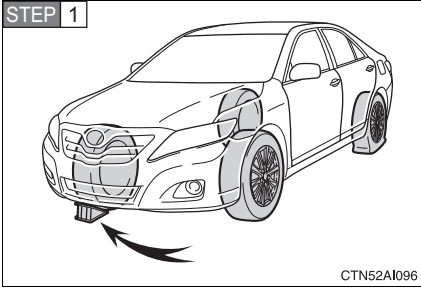

CTN52A1096

Check the tires.

Flat tire		Wheel chock positions
Front	Left-hand side	Behind the rear right-hand side tire
	Right-hand side	Behind the rear left-hand side tire
Rear	Left-hand side	In front of the front right-hand side tire
	Right-hand side	In front of the front left-hand side tire

**STEP 2**

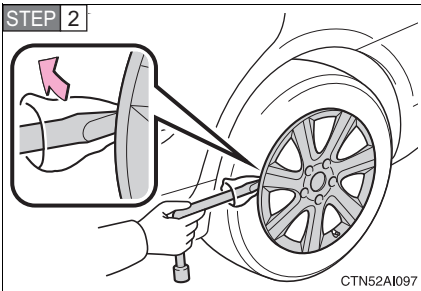

CTN52A1097

Vehicles with a steel wheel, remove the wheel ornament using the wrench.

To protect the wheel ornament, place a rag between the wrench and the wheel ornament, as shown in the illustration.

امداد خودرو فارما

۰۲۱-۸۸۶۲۰۸۵

FarmaSOS.com

## 5-2. Steps to take in an emergency

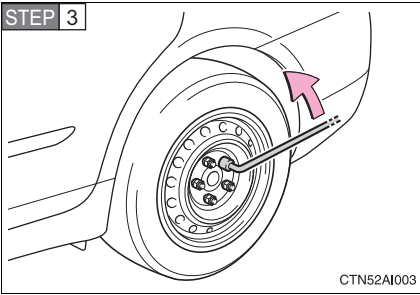

Slightly loosen the wheel nuts (one turn).

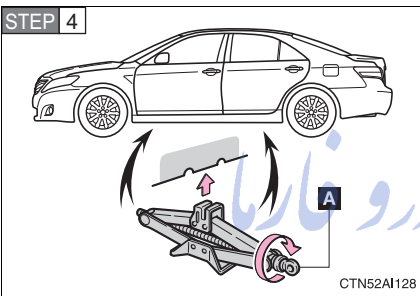

Turn the tire jack portion "A" by hand until the notch of the jack is in contact with the jack point.

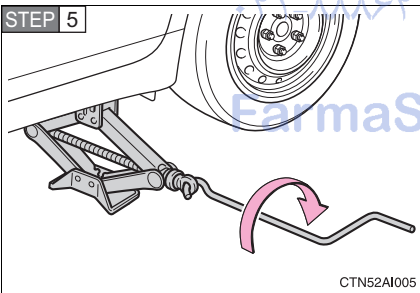

Raise the vehicle until the tire is slightly raised off the ground.

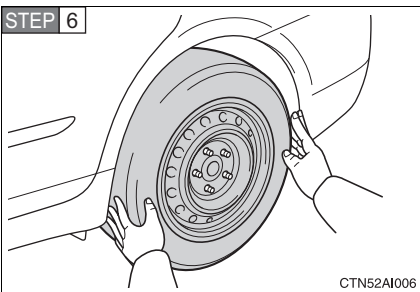

Remove all the wheel nuts and the tire.

When resting the tire on the ground, place the tire so that the wheel design faces up to avoid scratching the wheel surface.

## Installing the tire

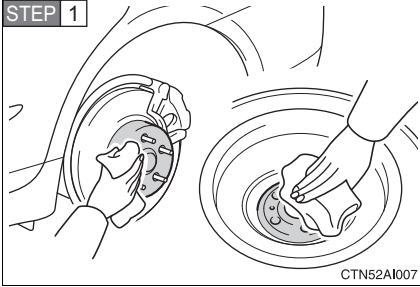

Remove any dirt or foreign matter from the wheel contact surface.

If foreign matter is on the wheel contact surface, the wheel nuts may loosen while the vehicle is in motion, and the tire may come off the vehicle.

STEP 2 Install the tire and loosely tighten each wheel nut by hand by approximately the same amount.

► Replacing a steel wheel with a steel wheel

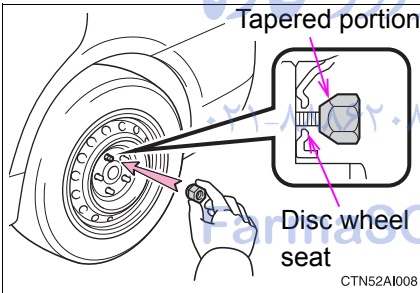

Tighten the nuts until the tapered portion comes into loose contact with the disc wheel seat.

تلفن شبانه روزی: ۰۲۱-۸۵۰۰۰۰۰۰

FarmanSOS.com

► Replacing an aluminum wheel with a steel wheel

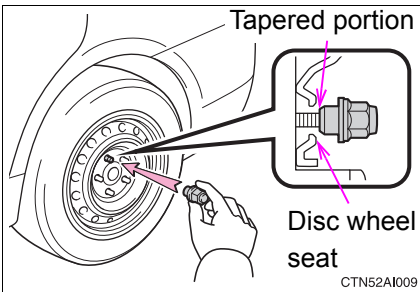

Tighten the nuts until the tapered portion comes into loose contact with the disc wheel sheet.

► Replacing an aluminum wheel with an aluminum wheel

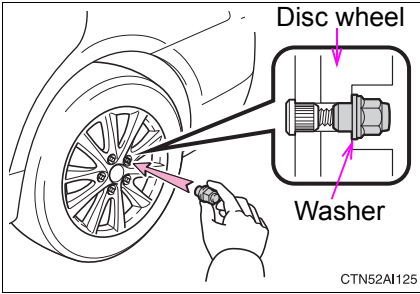

Turn the nuts until the washers come into contact with the disc wheel.

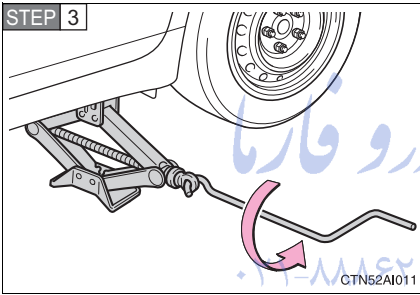

Lower the vehicle.

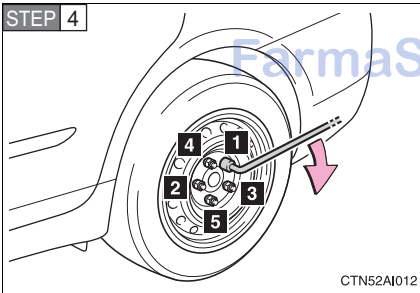

Firmly tighten each nut two or three times in the order shown in the illustration.

**Tightening torque:**

76 ft•lbf (103 N•m, 10.5 kgf•m)

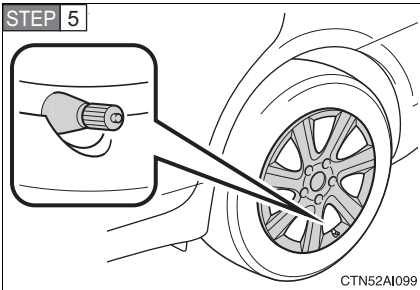

For vehicles with a steel wheel, reinstall the wheel ornament.

Align the cutout of the wheel ornament with the valve stem as shown.

**STEP 6** Stow the flat tire, tire jack and all tools.

### ■ The compact spare tire

- The compact spare tire is identified by the label “TEMPORARY USE ONLY” on the tire sidewall.  
Use the compact spare tire temporarily only in an emergency.
- Make sure to check the tire pressure of the compact spare tire.  
(→P. 491)

### ■ If you have a flat front tire on a road covered with snow or ice

Install the compact spare tire on the rear of the vehicle. Perform the following steps and fit tire chains to the front tires.

**STEP 1** Replace a rear tire with the compact spare tire.

**STEP 2** Replace the flat front tire with the tire removed from the rear of the vehicle.

**STEP 3** Fit tire chains to the front tires.

### ■ After completing the tire change (U.S.A. only)

The tire pressure warning system must be reset. (→P. 384)

### ■ When using the compact spare tire

As the compact spare tire is not equipped with the tire pressure warning valve and transmitter, low inflation pressure of the spare tire will not be warned. Also, if you replace the compact spare tire after the tire pressure warning light comes on, the light remains on.

### ■ Jack point guide

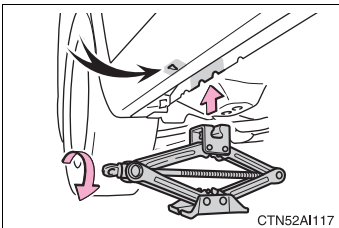

The jack point guides are located under the rocker panel. They indicate the jack point positions.



 CAUTION

■ **Using the tire jack**

Improper use of the tire jack may lead to death or serious injuries due to the vehicle suddenly falling off the jack.

- Do not use the tire jack for any purpose other than replacing tires or installing and removing tire chains.
- Only use the tire jack that comes with this vehicle for replacing a flat tire.  
Do not use it on other vehicles, and do not use other tire jacks for replacing tires on this vehicle.
- Always check that the tire jack is securely set to the jack point.
- Do not put any part of your body under the vehicle while it is supported by a jack.
- Do not start or run the engine while your vehicle is supported by the jack.
- Do not raise the vehicle while someone is in it.
- When raising the vehicle, do not put an object on or under the jack.
- Do not raise the vehicle to a height greater than that required to replace the tire.
- Use a jack stand if it is necessary to get under the vehicle.

Take particular care when lowering the vehicle to ensure that no one working on or near the vehicle will be injured.

 **CAUTION**
**■ Replacing a flat tire**

Observe the following precautions to reduce the risk of death or serious injury.

- Never use oil or grease on the wheel bolts or wheel nuts.  
Oil and grease may cause the wheel nuts to be excessively tightened, leading to bolt or disc wheel damage. In addition, the oil or grease can cause the wheel nuts to loosen and the wheel may fall off, causing a serious accident. Remove any oil or grease from the wheel bolts or wheel nuts.
- Have the wheel nuts tightened with a torque wrench to 76 ft•lbf (103 N•m, 10.5 kgf•m) as soon as possible after changing wheels.  
Failure to follow these precautions could cause the nuts to loosen and the wheel may fall off, which could lead to an accident causing death or serious injury.

**■ When using the compact spare tire**

- Remember that your compact spare tire is specifically designed for use with your vehicle. Do not use your compact spare tire on another vehicle.
- Do not use two compact spare tires simultaneously.
- Replace the compact spare tire with a standard tire as soon as possible.
- Avoid sudden acceleration, deceleration and braking, as well as sharp cornering.

**■ Speed limit when using the compact spare tire**

Do not drive at speeds in excess of 50 mph (80 km/h) when a compact spare tire is installed on the vehicle.

The compact spare tire is not designed for driving at high speeds. Failing to observe this precaution may lead to an accident causing death or serious injury.

 CAUTION

■ **When the spare tire is attached**

The vehicle speed may not be correctly detected, and the following systems may not operate correctly:

- ABS & Brake assist
- VSC
- TRAC
- Navigation system (if equipped)

 NOTICE

■ **Do not drive the vehicle with a flat tire.**

Do not continue driving with a flat tire.

Driving even a short distance with a flat tire can damage the tire and the wheel beyond repair.

■ **Be careful when driving over bumps with the compact spare tire installed on the vehicle.**

The vehicle becomes lower when driving with the compact spare tire compared to when driving with standard tires. Be careful when driving over uneven road surfaces.

■ **Driving with tire chains and the compact spare tire**

Do not fit tire chains to the compact spare tire.

Tire chains may damage the vehicle body and adversely affect driving performance.

■ **When replacing the tires**

When removing or fitting the wheels, tires or the tire pressure warning valve and transmitter, contact your Toyota dealer as the tire pressure warning valve and transmitter may be damaged if not handled correctly.

■ **To avoid damaging the tire pressure warning valves and transmitters**

Do not use liquid sealants on flat tires.

## 5-2. Steps to take in an emergency If the engine will not start

If the engine still does not start after following the correct starting procedure (→P. 131, 135) or releasing the steering lock (→P. 133, 136), confirm the following points.

■ **The engine will not start even when the starter motor operates normally.**

One of the following may be the cause of the problem.

- There may not be sufficient fuel in the vehicle's tank.  
Refuel the vehicle.
- The engine may be flooded.  
Try to restart the engine once more following correct starting procedures. (→P. 131, 135)
- There may be a malfunction in the engine immobilizer system.  
(→P. 80)

■ **The starter motor turns over slowly, the interior lights and headlights are dim, or the horn does not sound or sounds at a low volume.**

One of the following may be the cause of the problem.

- The battery may be discharged. (→P. 471)
- The battery terminal connections may be loose or corroded.

■ **The starter motor does not turn over (vehicles with smart key system).**

The engine starting system may be malfunctioning due to an electrical problem such as an open circuit or a blown fuse. However, an interim measure is available to start the engine.  
(→P. 466)

■ **The starter motor does not turn over, the interior lights and headlights do not turn on, or the horn does not sound.**

One of the following may be the cause of the problem.

- One or both of the battery terminals may be disconnected.
- The battery may be discharged. (→P. 471)
- There may be a malfunction in the steering lock system (vehicles with smart key system).

Contact your Toyota dealer if the problem cannot be repaired, or if repair procedures are unknown.

**Emergency start function (vehicles with smart key system)**

When the engine does not start, the following steps can be used as an interim measure to start the engine if the “ENGINE START STOP” switch is functioning normally.

**STEP 1** Set the parking brake.

**STEP 2** Shift the shift lever to P.

**STEP 3** Set the “ENGINE START STOP” switch to ACCESSORY mode.

**STEP 4** Press and hold the “ENGINE START STOP” switch for about 15 seconds while depressing the brake pedal firmly.

Even if the engine can be started using the above steps, the system may be malfunctioning. Have the vehicle checked by your Toyota dealer.

## 5-2. Steps to take in an emergency

### If the shift lever cannot be shifted from P (automatic transmission)

If the shift lever cannot be shifted with your foot on the brake, there may be a problem with the shift lock system (a system to prevent accidental operation of the shift lever). Have the vehicle inspected by your Toyota dealer.

The following steps may be used as an emergency measure to ensure that the shift lever can be shifted.

**STEP 1** Set the parking brake.

**STEP 2** Vehicles with smart key system: Turn the “ENGINE START STOP” switch to the ACCESSORY mode.

Vehicles without smart key system: Turn the engine switch to the “ACC” position.

**STEP 3** Depress the brake pedal.

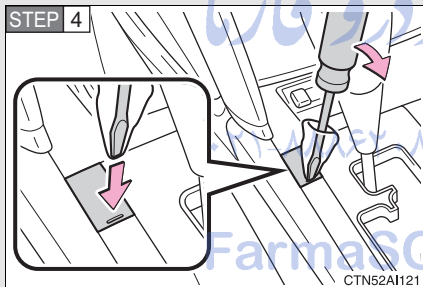

Pry the cover up with a flat-head screwdriver or equivalent.

تلفن شبانه روزی:

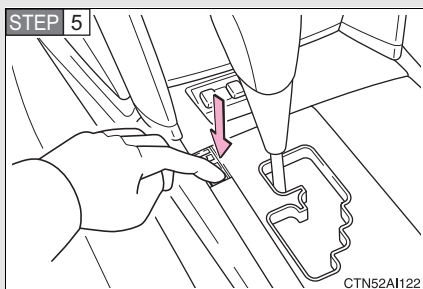

Press the shift lock override button.

The shift lever can be shifted while the button is pressed.

## 5-2. Steps to take in an emergency

### If you lose your keys

New genuine keys can be made by your Toyota dealer. For vehicles with the smart key system, bring the other key and the key number stamped on the key number plate. For vehicles without the smart key system, bring a master key and the key number stamped on the key number plate.

امداد خودرو فارما

تلفن شبانه روزی: ۰۲۱-۸۸۸۶۲۰۸۵

FarmaSOS.com

## 5-2. Steps to take in an emergency

### If the electronic key does not operate properly (vehicles with smart key system)

If communication between the electronic key and the vehicle is interrupted (→P. 30) or the electronic key cannot be used because the battery is depleted, the smart key system and wireless remote control cannot be used. In such cases, the doors and trunk can be opened or the engine can be started by following the procedure below.

#### Locking and unlocking the doors and opening the trunk with the mechanical key

##### ► Doors

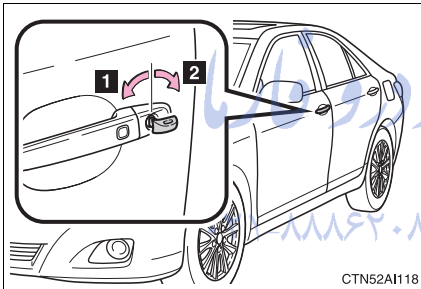

Using the mechanical key (→P. 25) in order to perform the following operations:

- 1 Locks all doors
- 2 Unlocks all doors

Turning the key rearward unlocks the driver's door. Turning the key once again unlocks the other doors.

##### ► Trunk

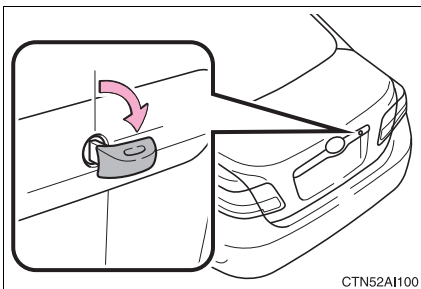

Turn the mechanical key clockwise to open.



## Changing “ENGINE START STOP” switch modes and starting the engine

**STEP 1** Shift the shift lever to P and apply the brakes.

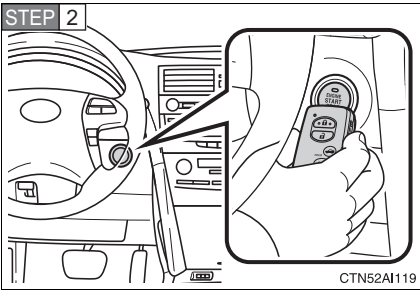

Touch the Toyota emblem side of the electronic key to the “ENGINE START STOP” switch.

An alarm will sound to indicate that the start function cannot detect the electronic key that is touched to the “ENGINE START STOP” switch if any of the doors is opened and closed while the key is touched to the switch.

**STEP 3** To change “ENGINE START STOP” switch modes: Within 10 seconds of the buzzer sounding, release the brake pedal and press the “ENGINE START STOP” switch. Modes can be changed each time the switch is pressed. (→P. 132)

To start the engine: Press the “ENGINE START STOP” switch within 10 seconds after the buzzer sounds, keeping the brake pedal depressed.

In the event that the “ENGINE START STOP” switch still cannot be operated, contact your Toyota dealer.

### ■ Stopping the engine

Shift the shift lever to P and press the “ENGINE START STOP” switch as you normally do when stopping the engine.

### ■ Replacing the key battery

As the above procedure is a temporary measure, it is recommended that the electronic key battery be replaced immediately when the battery is depleted. (→P. 401)

## 5-2. Steps to take in an emergency If the battery is discharged

The following procedures may be used to start the engine if the vehicle's battery is discharged.

You can call your Toyota dealer or qualified repair shop.

If you have a set of jumper (or booster) cables and a second vehicle with a 12-volt battery, you can jump start your Toyota following the steps below.

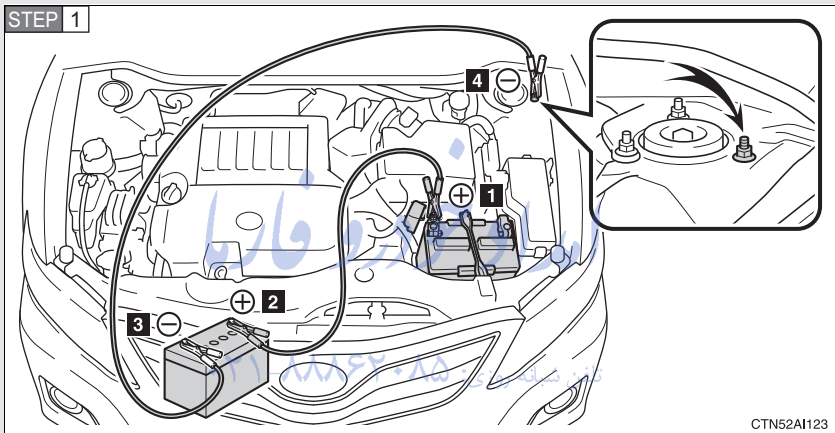

Connecting the jumper cables

- 1 Positive (+) battery terminal on your vehicle
- 2 Positive (+) battery terminal on the second vehicle
- 3 Negative (-) battery terminal on the second vehicle
- 4 Connect the jumper cable to ground on your vehicle as shown in the illustration.

**STEP 2** Start the engine of the second vehicle. Increase the engine speed slightly and maintain at that level for approximately 5 minutes to recharge the battery of your vehicle.

**STEP 3** Vehicles with smart key system — Open and close any of the doors with the “ENGINE START STOP” switch OFF.

**STEP 4** Maintain the engine speed of the second vehicle, and turn the “ENGINE START STOP” switch to IGNITION ON mode (vehicles with smart key system) or turn the engine switch to the “ON” position (vehicles without smart key system), then start the vehicle's engine.

**STEP 5** Once the vehicle's engine has started, remove the jumper cables in the exact reverse order in which they were connected.

Once the engine starts, have the vehicle checked at your Toyota dealer as soon as possible.

تلفن شماره یاری: ۰۲۱-۸۸۶۲۰۸۵

■ **Starting the engine when the battery is discharged (vehicles with automatic transmission)**

The engine cannot be started by push-starting.

■ **Avoiding a discharged battery**

- Turn off the headlights and the audio system while the engine is turned off.
- Turn off any unnecessary electrical components when the vehicle is running at a low speed for an extended period, such as in heavy traffic, etc.

 **CAUTION**
**■ Avoiding battery fires or explosions**

Observe the following precautions to prevent accidentally igniting the flammable gas that may be emitted from the battery.

- Make sure the jumper cable is connected to the correct terminal and that it is not unintentionally in contact with any part other than the intended terminal.
- Do not allow the jumper cables to come into contact with the “+” and “-” terminals.
- Do not smoke, use matches, cigarette lighters or allow open flame near the battery.

**■ Battery precautions**

The battery contains poisonous and corrosive acidic electrolyte, while related parts contain lead and lead compounds. Observe the following precautions when handling the battery.

- When working with the battery, always wear safety glasses and take care not to allow any battery fluids (acid) to come into contact with skin, clothing or the vehicle body.
- Do not lean over the battery.
- In the event that battery fluid comes into contact with the skin or eyes, immediately wash the affected area with water and seek medical attention. Place a wet sponge or cloth over the affected area until medical attention can be received.
- Always wash your hands after handling the battery support, terminals, and other battery-related parts.
- Do not allow children near the battery.

 NOTICE

■ **To prevent damage to the vehicle (vehicles with manual transmission)**

Do not pull- or push-start the vehicle, because the catalytic converter may overheat and become a fire hazard.

■ **When handling jumper cables**

Be careful that the jumper cables do not become tangled in the cooling fans or any of the belts when connecting or disconnecting them.

امداد خودرو فارما

تلفن شبانه روزی: ۰۲۱-۸۸۶۲۰۸۵

FarmaSOS.com

## 5-2. Steps to take in an emergency If your vehicle overheats

### If your engine overheats:

**STEP 1** Stop the vehicle in a safe place and turn off the air conditioning system.

**STEP 2** Check to see if steam is coming out from under the hood.

If you see steam:

Stop the engine. Carefully lift the hood after the steam subsides and then restart the engine.

If you do not see steam:

Leave the engine running and carefully lift the hood.

**STEP 3** 3.5 L V6 (2GR-FE) engine only: Remove the engine compartment cover. (→P. 367)

**STEP 4** Check to see if the cooling fans are operating.

If the fans are operating:

Wait until the temperature of the engine (shown on the instrument cluster) begins to fall and then stop the engine.

If the fans are not operating:

Stop the engine and call your Toyota dealer.

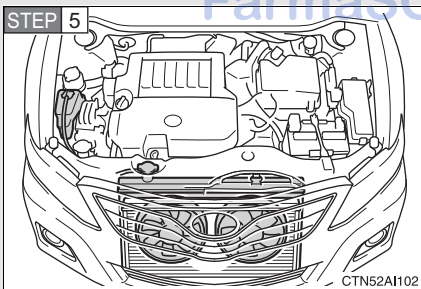

After the engine has cooled down sufficiently, check the engine coolant level and inspect the radiator core (radiator) for any leaks.

STEP 6

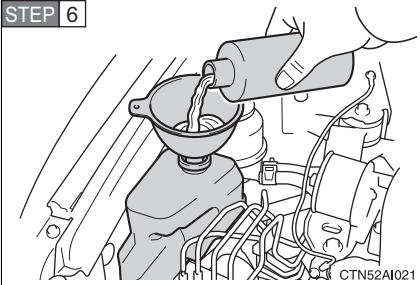

Add engine coolant if necessary.

Water can be used in an emergency if engine coolant is unavailable. (→P. 488)

Have the vehicle checked at the nearest Toyota dealer as soon as possible.

■ Overheating

If you observe the following, your vehicle may be overheating.

- The engine coolant temperature gauge enters the red zone or a loss of power is experienced.
- Steam is coming from under the hood.

⚠ CAUTION

■ To prevent an accident or injury when inspecting under the hood of your vehicle

- If steam is seen coming from under the hood, do not open the hood until the steam has subsided. The engine compartment may be very hot, causing serious injury such as burns.
- Keep hands and clothing away from the fan and other belts while the engine is running.
- Do not loosen the coolant reservoir cap while the engine and radiator are hot.  
Serious injury, such as burns, may result from hot coolant and steam released under pressure.

 NOTICE**■ When adding engine coolant**

Wait until the engine has cooled down before adding engine coolant.

When adding coolant, do so slowly. Adding cool coolant to a hot engine too quickly can cause damage to the engine.

امداد خودرو فارما

تلفن شبانه روزی: ۰۲۱-۸۸۶۲۰۸۵

FarmaSOS.com



## 5-2. Steps to take in an emergency If the vehicle becomes stuck

Carry out the following procedures if the tires spin or the vehicle becomes stuck in mud, dirt, or snow.

- STEP 1** Stop the engine. Set the parking brake and put the shift lever in P (automatic transmission) or N (manual transmission).
- STEP 2** Remove the mud, snow, or sand from around the stuck tire.
- STEP 3** Place wood, stones or some other material to help provide traction under the tires.
- STEP 4** Restart the engine.
- STEP 5** Shift the shift lever to the D or R position (automatic transmission) or 1 or R position (manual transmission) and carefully apply the accelerator to free the vehicle.

### ■ Emergency hooks (if equipped)

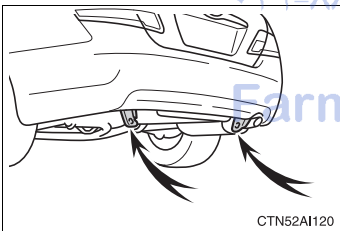

When your vehicle becomes stuck and cannot move, the emergency hooks are used for another vehicle to pull your vehicle out in an emergency.

Your vehicle is not designed to tow another vehicle.

 **CAUTION**

■ **When attempting to free a stuck vehicle**

If you choose to rock the vehicle back and forth to free it, make sure the surrounding area is clear, to avoid striking other vehicles, objects or persons. The vehicle may also lunge forward or lunge back suddenly as it becomes free. Use extreme caution.

■ **When shifting the shift lever**

For vehicles with an automatic transmission, be careful not to shift the shift lever with the accelerator pedal depressed.

This may lead to unexpected rapid acceleration of the vehicle that may cause an accident and result in death or serious injury.

 **NOTICE**

■ **To avoid damaging the transmission and other components**

- Avoid spinning the wheels and do not rev the engine.
- If the vehicle remains stuck after trying these procedures, the vehicle may require towing to be freed.

FarmaSOS.com

# امداد خودرو فارما

تلفن شبانه روزی: ۰۲۱-۸۸۸۶۲۰۸۵

**FarmaSOS.com**

## 6-1. Specifications

### Maintenance data (fuel, oil level, etc.)

#### Dimensions and weights

Overall length	189.2 in. (4805 mm)	
Overall width	71.7 in. (1820 mm)	
Overall height* <sup>1</sup>	57.7 in. (1465 mm)* <sup>2</sup> 57.9 in. (1470 mm)* <sup>3</sup>	
Wheelbase	109.3 in. (2775 mm)	
Tread	Front	62.0 in. (1575 mm)
	Rear	61.6 in. (1565 mm)
Vehicle capacity weight (Occupants + luggage)	900 lb. (410 kg)	
Towing capacity (trailer weight + cargo weight)	1000 lb. (453 kg)	

\*1: Unladen vehicles

\*2: P215/55R17 tires

\*3: P215/60R16 tires

تلفن شبانه روزی: ۰۲۱-۸۸۶۲۰۸۵

#### Vehicle identification

##### ■ Vehicle identification number

The vehicle identification number (VIN) is the legal identifier for your vehicle. This is the primary identification number for your Toyota. It is used in registering the ownership of your vehicle.

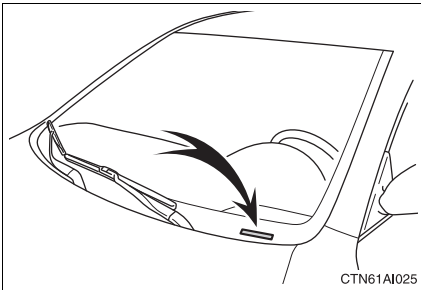

This number is stamped on the top left of the instrument panel.

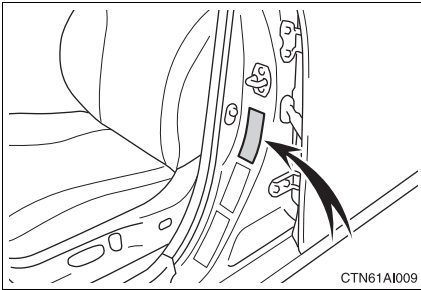

This number is also on the certification label on the driver's side center pillar.

### ■ Engine number

The engine number is stamped on the engine block as shown.

#### ► 2.5 L 4-cylinder (2AR-FE) engine

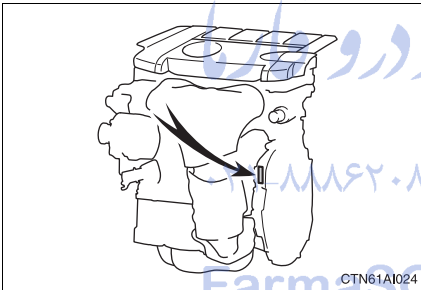

#### ► 3.5 L V6 (2GR-FE) engine

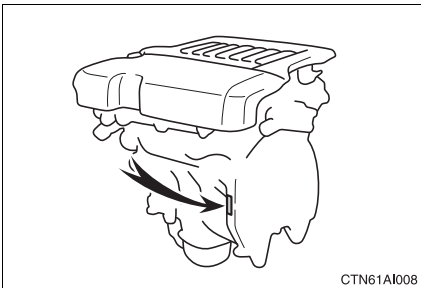

## Engine

Model	2AR-FE	2GR-FE
Type	4 cylinder in line, 4 cycle, gasoline	6 cylinder V type, 4 cycle, gasoline
Bore and stroke	3.54 × 3.86 in. (90.0 × 98.0 mm)	3.70 × 3.27 in. (94.0 × 83.0 mm)
Displacement	152.2 cu.in. (2494 cm <sup>3</sup> )	210.9 cu.in. (3456 cm <sup>3</sup> )
Drive belt tension	Automatic adjustment	
Valve clearance (engine cold)	Automatic adjustment	

## ⚠ NOTICE

### ■ Drive belt type (2.5 L 4-cylinder [2AR-FE] engine only)

The high strength drive belt is used for the generator side drive belt.

When replacing the drive belt, use Toyota genuine drive belt or equivalent high strength drive belt. If the high strength drive belt is not used, durability of the belt may become less than expected. The high strength drive belt is a belt with Aramid core which has higher strength compared to usually available belts with PET or PEN core.

## Fuel

Fuel type	Unleaded gasoline only
Octane rating	87 (Research Octane Number 91) or higher
Fuel tank capacity	18.5 gal. (70 L, 15.4 Imp. gal.)

## Lubrication system

Oil capacity (drain and refill)	
With filter	<ul style="list-style-type: none"> <li>▶ 2.5 L 4-cylinder (2AR-FE) engine 4.7 qt. (4.4 L, 3.9 Imp. qt.)</li> <li>▶ 3.5 L V6 (2GR-FE) engine 6.4 qt. (6.1 L, 5.4 Imp. qt.)</li> </ul>
Without filter	<ul style="list-style-type: none"> <li>▶ 2.5 L 4-cylinder (2AR-FE) engine 4.2 qt. (4.0 L, 3.5 Imp. qt.)</li> <li>▶ 3.5 L V6 (2GR-FE) engine 6.0 qt. (5.7 L, 5.0 Imp. qt.)</li> </ul>

### ■ Engine oil selection

“Toyota Genuine Motor Oil” is used in your Toyota vehicle. Use Toyota approved “Toyota Genuine Motor Oil” or equivalent to satisfy the following grade and viscosity.

Oil grade: ILSAC multigrade engine oil

▶ 2.5 L 4-cylinder (2AR-FE) engine: تلفن شبانه روزی: ۰۲۱-۸۸۴۲۰۸۵

Recommended viscosity: SAE 0W-20

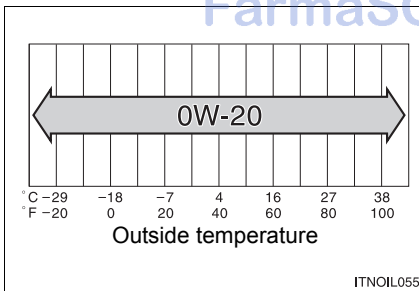

SAE 0W-20 is the best choice for good fuel economy and good starting in cold weather.

If SAE 0W-20 is not available, SAE 5W-20 oil may be used. However, it must be replaced with SAE 0W-20 at the next oil change.

The 0W portion of the oil viscosity rating indicates the characteristic of the oil which allows cold startability. Oils with a lower value before the W allow for easier starting of the engine in cold weather.

The 20 in 0W-20 indicates the oil viscosity when the oil is at its operating temperature. An oil with a higher viscosity may be better suited if the vehicle is operated at high speeds, or under extreme load conditions.

How to read oil container label:

The ILSAC (International Lubricant Standardization and Approval Committee) Certification Mark is added to some oil containers to help you select the oil you should use.



► 3.5 L V6 (2GR-FE) engine

Recommended viscosity: SAE 5W-30

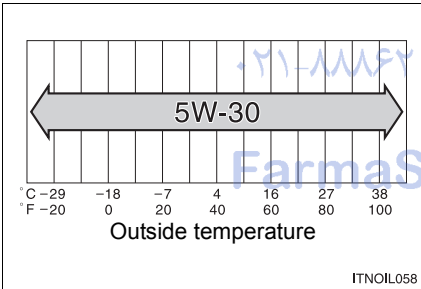

SAE 5W-30 is the best choice for good fuel economy and good starting in cold weather.

If SAE 5W-30 is not available, SAE 10W-30 oil may be used. However, it should be replaced with SAE 5W-30 at the next oil change.

The 5W portion of the oil viscosity rating indicates the characteristic of the oil which allows cold startability. Oils with a lower value before the W allow for easier starting of the engine in cold weather.

The 30 in 5W-30 indicates the oil viscosity when the oil is at its operating temperature. An oil with a higher viscosity may be better suited if the vehicle is operated at high speeds, or under extreme load conditions.



How to read oil container label:

The ILSAC (International Lubricant Standardization and Approval Committee) Certification Mark is added to some oil containers to help you select the oil you should use.



امداد خودرو فارما

تلفن شبانه روزی: ۰۲۱-۸۸۶۲۰۸۵

FarmaSOS.com

### Cooling system

Capacity (Reference)	<ul style="list-style-type: none"> <li>▶ 2.5 L 4-cylinder (2AR-FE) engine 7.5 qt. (7.1 L, 6.2 Imp. qt.)</li> <li>▶ 3.5 L V6 (2GR-FE) engine 9.5qt. (9.0 L, 7.9 Imp. qt.)</li> </ul>
Coolant type	<p>Use either of the following.</p> <ul style="list-style-type: none"> <li>• “Toyota Super Long Life Coolant”</li> <li>• Similar high-quality ethylene glycol-based non-silicate, non-amine, non-nitrite, and non-borate coolant with long-life hybrid organic acid technology</li> </ul> <p>Do not use plain water alone.</p>

### Ignition system

Spark plug	
Make	<ul style="list-style-type: none"> <li>▶ 2.5 L 4-cylinder (2AR-FE) engine DENSO SK16HR11</li> <li>▶ 3.5 L V6 (2GR-FE) engine DENSO FK20HR11</li> </ul>
Gap	0.043 in. (1.1 mm)

### NOTICE

#### ■ Iridium-tipped spark plugs

Use only iridium-tipped spark plugs. Do not adjust spark plug gap.

**Electrical system**

Battery	12.6 — 12.8 V Fully charged 12.2 — 12.4 V Half charged 11.8 — 12.0 V Discharged (Voltage checked 20 minutes after the engine and all the lights turned off)
Open voltage at 68°F (20°C):	
Charging rates	5 A max.

**Manual transaxle**

Gear oil capacity (Reference)	2.4 qt. (2.3 L, 2.0 Imp. qt.)
Gear oil type	API GL-4
Recommended gear oil viscosity	SAE 75W

**Automatic transaxle**

Fluid capacity*	6.9 qt. (6.5 L, 5.7 Imp. qt.)
Fluid type	Toyota Genuine ATF WS

\*: The fluid capacity is the quantity of reference. If replacement is necessary, contact your Toyota dealer.

 **NOTICE****Automatic transmission fluid type**

Using automatic transmission fluid other than “Toyota Genuine ATF WS” may cause deterioration in shift quality, locking up of your transmission accompanied by vibration, and ultimately damage the transmission of your vehicle.

**Clutch**

Pedal free play	0.2 — 0.6 in. (5 — 15 mm)
Fluid type	SAE J1703 or FMVSS No.116 DOT 3

**Brakes**

Pedal clearance* <sup>1</sup>	<ul style="list-style-type: none"> <li>▶ Automatic transmission 2.4 in. (61 mm)</li> <li>▶ Manual transmission 2.5 in. (63 mm)</li> </ul>
Pedal free play	0.04 — 0.24 in. (1 — 6 mm)
Brake pad wear limit	0.04 in. (1.0 mm)
Parking brake lever travel* <sup>2</sup>	7 — 9 clicks
Parking brake pedal travel* <sup>3</sup>	7 — 10 clicks
Fluid type	SAE J1703 or FMVSS No.116 DOT 3

\*1: Minimum pedal clearance when depressed with a force of 112 lbf (500 N, 51 kgf) while the engine is running

\*2: Parking brake lever travel when pulled up with a force of 44 lbf (200 N, 20 kgf)

\*3: Parking brake pedal travel when depressed with a force of 67 lbf (300 N, 31 kgf).

## Steering

Free play	Less than 1.2 in. (30 mm)
Power steering fluid type	Automatic transmission fluid DEXRON® II or III

## Tires and wheels

### ► 3.5 L V6 (2GR-FE) engine with 16-inch tires

Tire size	P215/60R16 94V, T155/70D17 110M
Tire inflation pressure (Recommended cold tire inflation pressure)	<p>Driving under normal conditions</p> <p>Front: 30 psi (210 kPa, 2.1 kgf/cm<sup>2</sup> or bar)*</p> <p>Rear: 30 psi (210 kPa, 2.1 kgf/cm<sup>2</sup> or bar)*</p> <p>Spare:</p> <ul style="list-style-type: none"> <li>► Full-size spare tire 30 psi (210 kPa, 2.1 kgf/cm or bar)</li> <li>► Compact spare tire 60 psi (420 kPa, 4.2 kgf/cm or bar)</li> </ul> <p>*: When driving at high speeds above 100 mph (160 km/h), in countries where such speeds are permitted by law, add 5 psi (30 kPa, 0.3 kgf/cm<sup>2</sup> or bar) to the front tires and rear tires. Never exceed the maximum cold tire inflation pressure indicated on the tire sidewall.</p>
Wheel size	16 × 6 1/2 J or 16 × 6 1/2 JJ, 17 × 4 T (compact spare)
Wheel nut torque	76 ft•lbf (103 N•m, 10.5 kgf•m)

## ▶ 2.5 L 4-cylinder (2AR-FE) engine with 16-inch tires

Tire size	P215/60R16 94V, T155/70D17 110M
Tire inflation pressure (Recommended cold tire inflation pressure)	<p>Driving under normal conditions</p> <p>Front: 34 psi (230 kPa, 2.3 kgf/cm<sup>2</sup> or bar)*</p> <p>Rear: 34 psi (230 kPa, 2.3 kgf/cm<sup>2</sup> or bar)*</p> <p>Spare:</p> <ul style="list-style-type: none"> <li>▶ Full-size spare tire 34 psi (230 kPa, 2.3 kgf/cm or bar)</li> <li>▶ Compact spare tire 60 psi (420 kPa, 4.2 kgf/cm or bar)</li> </ul> <p>*: When driving at high speeds above 100 mph (160 km/h), in countries where such speeds are permitted by law, add 1 psi (10 kPa, 0.1 kgf/cm<sup>2</sup> or bar) to the front tires and rear tires. Never exceed the maximum cold tire inflation pressure indicated on the tire sidewall.</p>
Wheel size	16 × 6 1/2 J or 16 × 6 1/2 JJ, 17 × 4 T (compact spare)
Wheel nut torque	76 ft•lbf (103 N•m, 10.5 kgf•m)

## ► Others

Tire size	P215/60R16 94V, P215/55R17 93V, T155/70D17 110M
Tire inflation pressure (Recommended cold tire inflation pressure)	<p>Driving under normal conditions</p> <p>Front: 32 psi (220 kPa, 2.2 kgf/cm<sup>2</sup> or bar)*</p> <p>Rear: 32 psi (220 kPa, 2.2 kgf/cm<sup>2</sup> or bar)*</p> <p>Spare:</p> <ul style="list-style-type: none"> <li>► Full-size spare tire 32 psi (220 kPa, 2.2 kgf/cm or bar)</li> <li>► Compact spare tire 60 psi (420 kPa, 4.2 kgf/cm or bar)</li> </ul> <p>*: When driving at high speeds above 100 mph (160 km/h), in countries where such speeds are permitted by law, add 3 psi (20 kPa, 0.2 kgf/cm<sup>2</sup> or bar) to the front tires and rear tires. Never exceed the maximum cold tire inflation pressure indicated on the tire sidewall.</p>
Wheel size	16 × 6 1/2 J or 16 × 6 1/2 JJ, 17 × 7 J, 17 × 4 T (compact spare)
Wheel nut torque	76 ft•lbf (103 N•m, 10.5 kgf•m)

<b>Light bulbs</b>
--------------------

	Light Bulbs	Bulb No.	W	Type
Exterior	Headlights Low beam	—	55	A
	High beam	9005	60	B
	Front side marker/ parking lights	—	5	D
	Front turn signal lights	—	21	D
	Rear turn signal lights	—	21	C
	License plate lights	—	5	C
	Back-up lights	921	16	C
Front fog lights (if equipped)	—	55	A	
Interior	Personal lights Front	—	5	C
	Rear	—	8	C
	Interior light	—	8	E
	Door courtesy lights	168	5	C
	Vanity lights	—	8	C
	Glove box light	—	1.2	C
Trunk light	—	3.8	C	

A: H11 halogen bulbs

B: HB3 halogen bulbs

C: Wedge base bulbs (clear)

D: Wedge base bulbs (amber)

E: Double end bulbs



## 6-1. Specifications

### Fuel information

**Your vehicle must use only unleaded gasoline.**

**Select octane rating 87 (Research Octane Number 91) or higher. Use of unleaded gasoline with an octane rating lower than 87 may result in engine knocking. Persistent knocking can lead to engine damage.**

At minimum, the gasoline you use should meet the specifications of ASTM D4814 in the U.S.A. and CGSB3.5-M93 in Canada.

#### ■ Fuel tank opening for unleaded gasoline

To help prevent incorrect fueling, your Toyota has a fuel tank opening that only accommodates the special nozzle on unleaded fuel pumps.

#### ■ If your engine knocks

- Consult your Toyota dealer.
- You may occasionally notice light knocking for a short time while accelerating or driving uphill. This is normal and there is no need for concern.

#### ■ Gasoline quality تلفن شبانه روزی: ۰۲۱-۸۸۶۲۰۸۵

In very few cases, driveability problems may be caused by the brand of gasoline you are using. If driveability problems persist, try changing the brand of gasoline. If this does not correct the problem, consult your Toyota dealer.

#### ■ Gasoline quality standards

- Automotive manufacturers in the U.S., the Europe and Japan have developed a specification for fuel quality called World-Wide Fuel Charter (WWFC) that is expected to be applied worldwide.
- The WWFC consists of four categories that are based on required emission levels. In the U.S., category 4 has been adopted.
- The WWFC improves air quality by lowering emissions in vehicle fleets, and improves customer satisfaction through better performance.

■ **Toyota recommends the use of gasoline containing detergent additives**

- Toyota recommends the use of gasoline that contains detergent additives to avoid build-up of engine deposits.
- All gasoline sold in the U.S. contains detergent additives to clean and/or keep clean intake systems.

■ **Toyota recommends the use of cleaner burning gasoline**

Cleaner burning gasoline, including reformulated gasoline that contains oxygenates such as ethanol or MTBE (Methyl Tertiary Butyl Ether) is available in many areas.

Toyota recommends the use of cleaner burning gasoline and appropriately blended reformulated gasoline. These types of gasoline provide excellent vehicle performance, reduce vehicle emissions and improve air quality.

■ **Toyota does not recommend blended gasoline**

- Toyota allows the use of oxygenate blended gasoline where the oxygenate content is up to 10% ethanol or 15% MTBE.
- If you use gasohol in your Toyota, be sure that it has an octane rating no lower than 87.
- Toyota does not recommend the use of gasoline containing methanol.

■ **Toyota does not recommend gasoline containing MMT**

Some gasoline contains octane enhancing additive called MMT (Methylcyclopentadienyl Manganese Tricarbonyl).

Toyota does not recommend the use of gasoline that contains MMT. If fuel containing MMT is used, your emission control system may be adversely affected.

The malfunction indicator lamp on the instrument cluster may come on. If this happens, contact your Toyota dealer for service.

 NOTICE

■ **Notice on fuel quality**

- Do not use improper fuels. If improper fuels are used the engine will be damaged.
- Do not use leaded gasoline.  
Leaded gasoline can cause damage to your vehicle's catalytic converters causing the emission control system to malfunction.
- Do not use gasohol other than that stated here.  
Other gasohol may cause fuel system damage or vehicle performance problems.
- Using unleaded gasoline with an octane number or rating lower than that stated here will cause persistent heavy knocking.  
At worst, this will lead to engine damage.

■ **Fuel-related poor driveability**

If after using a different type of fuel, poor driveability is encountered (poor hot starting, vaporization, engine knocking, etc.), discontinue the use of that type of fuel.

■ **When refueling with gasohol**

Take care not to spill gasohol. It can damage your vehicle's paint.

FarmaSOS.com

# 6-1. Specifications

## Tire information

### Typical tire symbols

#### ► Standard tire

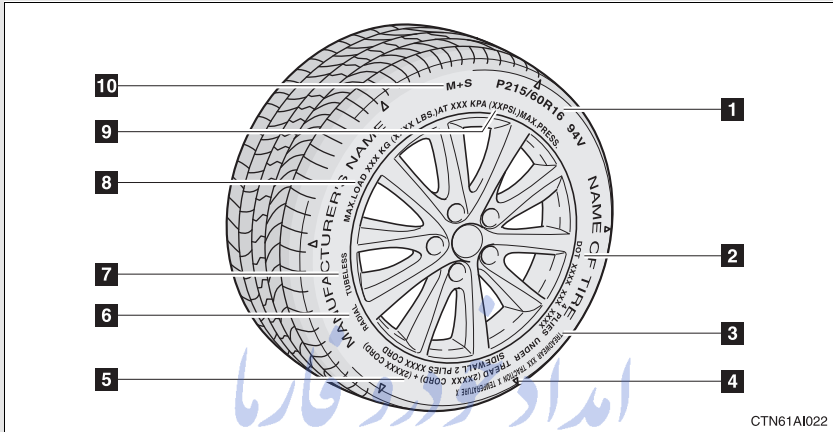

#### ► Compact spare tire

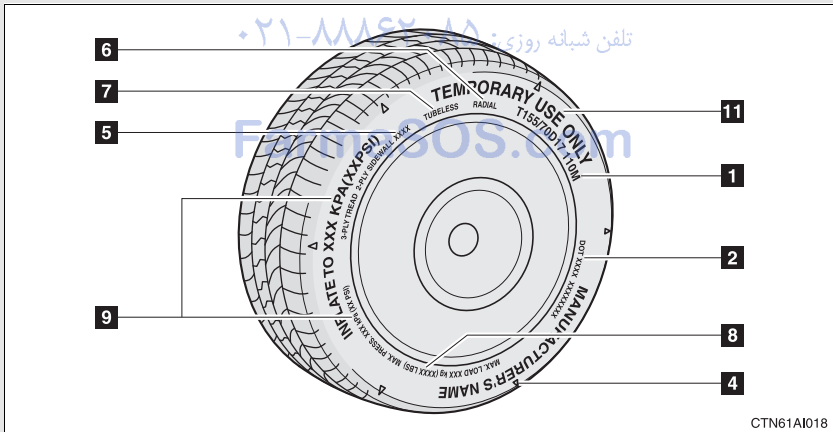

- 1** Tire size (→P. 501)
- 2** DOT and Tire Identification Number (TIN) (→P. 500)
- 3** Uniform tire quality grading  
For details, see “Uniform Tire Quality Grading” that follows.
- 4** Location of treadwear indicators (→P. 382)

**5** Tire ply composition and materials

Plies are layers of rubber-coated parallel cords. Cords are the strands which form the plies in a tire.

**6** Radial tires or bias-ply tires

A radial tire has “RADIAL” on the sidewall. A tire not marked “RADIAL” is a bias-ply tire.

**7** TUBELESS or TUBE TYPE

A tubeless tire does not have a tube and air is directly filled in the tire. A tube type tire has a tube inside the tire and the tube maintains the air pressure.

**8** Load limit at maximum cold tire inflation pressure (→P. 387)**9** Maximum cold tire inflation pressure (→P. 491)

This means the pressure to which a tire may be inflated.

**10** Summer tires or all season tires (→P. 388)

An all season tire has “M+S” on the sidewall. A tire not marked “M+S” is a summer tire.

**11** “TEMPORARY USE ONLY” (→P. 461)

A compact spare tire is identified by the phrase “TEMPORARY USE ONLY” molded into its sidewall. This tire is designed for temporary emergency use only.

## Typical DOT and Tire Identification Number (TIN)

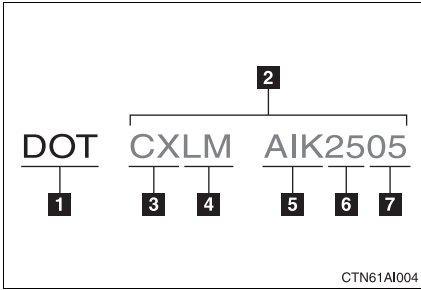

- 1** DOT symbol\*
- 2** Tire Identification Number (TIN)
- 3** Tire manufacturer's identification mark
- 4** Tire size code
- 5** Manufacturer's optional tire type code (3 or 4 letters)
- 6** Manufacturing week
- 7** Manufacturing year

\*: The DOT symbol certifies that the tire conforms to applicable Federal Motor Vehicle Safety Standards.

تلفن شبانه روزی: ۰۲۱-۸۸۶۲۰۸۵

FarmaSOS.com

## Tire size

### ■ Typical tire size information

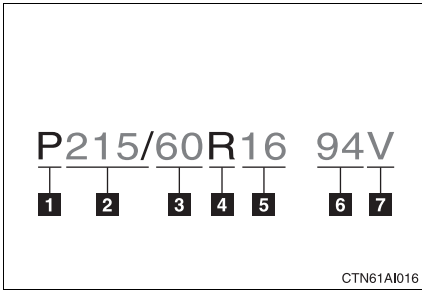

The illustration indicates typical tire size.

- 1** Tire use  
(P = Passenger car,  
T = Temporary use)
- 2** Section width (millimeters)
- 3** Aspect ratio  
(tire height to section width)
- 4** Tire construction code  
(R = Radial, D = Diagonal)
- 5** Wheel diameter (inches)
- 6** Load index (2 or 3 digits)
- 7** Speed symbol  
(alphabet with one letter)

### ■ Tire dimensions

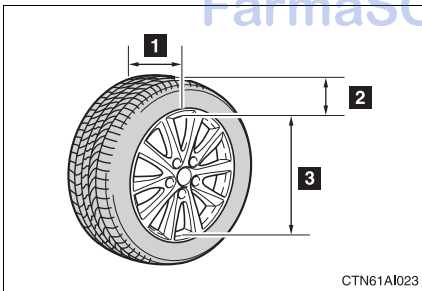

- 1** Section width
- 2** Tire height
- 3** Wheel diameter

## Tire section names

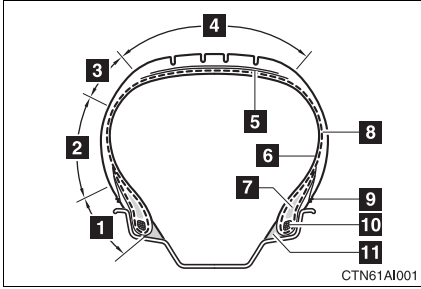

- 1 Bead
- 2 Sidewall
- 3 Shoulder
- 4 Tread
- 5 Belt
- 6 Inner liner
- 7 Reinforcing rubber
- 8 Carcass
- 9 Rim lines
- 10 Bead wires
- 11 Chafer

## Uniform Tire Quality Grading

This information has been prepared in accordance with regulations issued by the National Highway Traffic Safety Administration of the U.S.A. Department of Transportation.

It provides the purchasers and/or prospective purchasers of Toyota vehicles with information on uniform tire quality grading.

Your Toyota dealer will help answer any questions you may have as you read this information.

### ■ DOT quality grades

All passenger vehicle tires must conform to Federal Safety Requirements in addition to these grades. Quality grades can be found where applicable on the tire sidewall between tread shoulder and maximum section width.

For example: Treadwear 200 Traction AA Temperature A



### ■ Treadwear

The treadwear grade is a comparative rating based on the wear rate of the tire when tested under controlled conditions on a specified government test course.

For example, a tire graded 150 would wear one and a half (1-1/2) times as well on the government course as a tire graded 100.

The relative performance of tires depends upon the actual conditions of their use, however, and may depart significantly from the norm due to variations in driving habits, service practices and differences in road characteristics and climate.

### ■ Traction AA, A, B, C

The traction grades, from highest to lowest, are AA, A, B and C, and they represent the tire's ability to stop on wet pavement as measured under controlled conditions on specified government test surfaces of asphalt and concrete.

A tire marked C may have poor traction performance.

Warning: The traction grade assigned to this tire is based on braking (straight ahead) traction tests and does not include cornering (turning) traction.

### ■ Temperature A, B, C

The temperature grades are A (the highest), B, and C, representing the tire's resistance to the generation of heat and its ability to dissipate heat when tested under controlled conditions on a specified indoor laboratory test wheel.

Sustained high temperature can cause the material of the tire to degenerate and reduce tire life, and excessive temperature can lead to sudden tire failure.

The grade C corresponds to a level of performance which all passenger car tires must meet under the Federal Motor Vehicle Safety Standard No. 109.

Grades B and A represent higher levels of performance on the laboratory test wheel than the minimum required by law.

Warning: The temperature grades for this tire are established for a tire that is properly inflated and not overloaded.

Excessive speed, underinflation, or excessive loading, either separately or in combination, can cause heat buildup and possible tire failure.

### Glossary of tire terminology

Tire related term	Meaning
Cold tire inflation pressure	Tire pressure when the vehicle has been parked for three hours or more, or has not been driven more than 1 mile or 1.5 km under that condition
Maximum inflation pressure	The maximum cold inflated pressure to which a tire may be inflated, shown on the sidewall of the tire
Recommended inflation pressure	Cold tire inflation pressure recommended by a manufacturer
Accessory weight	The combined weight (in excess of those standard items which may be replaced) of automatic transmission, power steering, power brakes, power windows, power seats, radio and heater, to the extent that these items are available as factory-installed equipment (whether installed or not)
Curb weight	The weight of a motor vehicle with standard equipment, including the maximum capacity of fuel, oil and coolant, and if so equipped, air conditioning and additional weight optional engine
Maximum loaded vehicle weight	The sum of: (a) Curb weight (b) Accessory weight (c) Vehicle capacity weight (d) Production options weight

Tire related term	Meaning
Normal occupant weight	150 lb. (68 kg) times the number of occupants specified in the second column of Table 1* that follows
Occupant distribution	Distribution of occupants in a vehicle as specified in the third column of Table 1* below
Production options weight	The combined weight of installed regular production options weighing over 5 lb. (2.3 kg) in excess of the standard items which they replace, not previously considered in curb weight or accessory weight, including heavy duty brakes, ride levelers, roof rack, heavy duty battery, and special trim
Rim	A metal support for a tire or a tire and tube assembly upon which the tire beads are seated
Rim diameter (Wheel diameter)	Nominal diameter of the bead seat
Rim size designation	Rim diameter and width
Rim type designation	The industry manufacturer's designation for a rim by style or code
Rim width	Nominal distance between rim flanges
Vehicle capacity weight (Total load capacity)	The rated cargo and luggage load plus 150 lb. (68 kg) times the vehicle's designated seating capacity
Vehicle maximum load on the tire	The load on an individual tire that is determined by distributing to each axle its share of the maximum loaded vehicle weight, and dividing by two
Vehicle normal load on the tire	The load on an individual tire that is determined by distributing to each axle its share of curb weight, accessory weight, and normal occupant weight (distributed in accordance with Table 1* below), and dividing by two

Tire related term	Meaning
Weather side	The surface area of the rim not covered by the inflated tire
Bead	The part of the tire that is made of steel wires, wrapped or reinforced by ply cords and that is shaped to fit the rim
Bead separation	A breakdown of the bond between components in the bead
Bias ply tire	A pneumatic tire in which the ply cords that extend to the beads are laid at alternate angles substantially less than 90 degrees to the centerline of the tread
Carcass	The tire structure, except tread and sidewall rubber which, when inflated, bears the load
Chunking	The breaking away of pieces of the tread or sidewall
Cord	The strands forming the plies in the tire
Cord separation	The parting of cords from adjacent rubber compounds
Cracking	Any parting within the tread, sidewall, or innerliner of the tire extending to cord material
CT	A pneumatic tire with an inverted flange tire and rim system in which the rim is designed with rim flanges pointed radially inward and the tire is designed to fit on the underside of the rim in a manner that encloses the rim flanges inside the air cavity of the tire
Extra load tire	A tire designed to operate at higher loads and at higher inflation pressures than the corresponding standard tire
Groove	The space between two adjacent tread ribs
Innerliner	The layer(s) forming the inside surface of a tubeless tire that contains the inflating medium within the tire

Tire related term	Meaning
Innerliner separation	The parting of the innerliner from cord material in the carcass
Intended outboard sidewall	<p>(a) The sidewall that contains a whitewall, bears white lettering, or bears manufacturer, brand, and/or model name molding that is higher or deeper than the same molding on the other sidewall of the tire, or</p> <p>(b) The outward facing sidewall of an asymmetrical tire that has a particular side that must always face outward when mounted on a vehicle</p>
Light truck (LT) tire	A tire designated by its manufacturer as primarily intended for use on lightweight trucks or multipurpose passenger vehicles
Load rating	The maximum load that a tire is rated to carry for a given inflation pressure
Maximum load rating	The load rating for a tire at the maximum permissible inflation pressure for that tire
Maximum permissible inflation pressure	The maximum cold inflation pressure to which a tire may be inflated
Measuring rim	The rim on which a tire is fitted for physical dimension requirements
Open splice	Any parting at any junction of tread, sidewall, or innerliner that extends to cord material
Outer diameter	The overall diameter of an inflated new tire
Overall width	The linear distance between the exteriors of the sidewalls of an inflated tire, including elevations due to labeling, decorations, or protective bands or ribs
Passenger car tire	A tire intended for use on passenger cars, multipurpose passenger vehicles, and trucks, that have a gross vehicle weight rating (GVWR) of 10,000 lb. or less.

Tire related term	Meaning
Ply	A layer of rubber-coated parallel cords
Ply separation	A parting of rubber compound between adjacent plies
Pneumatic tire	A mechanical device made of rubber, chemicals, fabric and steel or other materials, that, when mounted on an automotive wheel, provides the traction and contains the gas or fluid that sustains the load
Radial ply tire	A pneumatic tire in which the ply cords that extend to the beads are laid at substantially 90 degrees to the centerline of the tread
Reinforced tire	A tire designed to operate at higher loads and at higher inflation pressures than the corresponding standard tire
Section width	The linear distance between the exteriors of the sidewalls of an inflated tire, excluding elevations due to labeling, decoration, or protective bands
Sidewall	That portion of a tire between the tread and bead
Sidewall separation	The parting of the rubber compound from the cord material in the sidewall
Snow tire	A tire that attains a traction index equal to or greater than 110, compared to the ASTM-E 1136 Standard Reference Test Tire, when using the snow traction test as described in ASTM F-1805-00, Standard Test Method for Single Wheel Driving Traction in a Straight Line on Snow-and Ice-Covered Surfaces, and which is marked with an Alpine Symbol (  ) on at least one sidewall
Test rim	The rim on which a tire is fitted for testing, and may be any rim listed as appropriate for use with that tire

Tire related term	Meaning
Tread	That portion of a tire that comes into contact with the road
Tread rib	A tread section running circumferentially around a tire
Tread separation	Pulling away of the tread from the tire carcass
Treadwear indicators (TWI)	The projections within the principal grooves designed to give a visual indication of the degrees of wear of the tread
Wheel-holding fixture	The fixture used to hold the wheel and tire assembly securely during testing

\*: Table 1 — Occupant loading and distribution for vehicle normal load for various designated seating capacities

Designated seating capacity, Number of occupants	Vehicle normal load, Number of occupants	Occupant distribution in a normally loaded vehicle
2 through 4	2	2 in front
5 through 10	3	2 in front, 1 in second seat
11 through 15	5	2 in front, 1 in second seat, 1 in third seat, 1 in fourth seat
16 through 20	7	2 in front, 2 in second seat, 2 in third seat, 1 in fourth seat

## 6-2. Customization

### Customizable features

Your vehicle includes a variety of electronic features that can be personalized to your preferences. Programming these preferences requires specialized equipment and may be performed by your Toyota dealer.

Some function settings are changed simultaneously with other functions being customized. Contact your Toyota dealer.

Item	Function	Default setting	Customized setting
Smart key system (→P. 27)	Smart key system	On	Off
	Operation signal (Emergency flashers)	On	Off
	Operation signal (Buzzer)	On	Off
Wireless remote control (→P. 38)	Wireless remote control	On	Off
	Unlocking operation	Driver's door unlocked in one step, all doors unlocked in two steps	All doors unlocked in one step.
	Automatic door lock function to be activated if door is not opened after being unlocked	On	Off



Item	Function	Default setting	Customized setting
Wireless remote control (→P. 38)	Time elapsed before automatic door lock function is activated if door is not opened after being unlocked	60 seconds	30 seconds
			120 seconds
	Operation signal (Emergency flashers)	On	Off
	Operation signal (Buzzer)	On	Off
	Door lock buzzer	On	Off
	Panic function	On	Off
	Trunk unlocking function (vehicles with smart key system only)	On	Off
	Trunk unlocking operation (vehicles with smart key system)	Press and hold	Press twice
			One short press
	Trunk unlocking operation (vehicles without smart key system)	Press and briefly hold	Press twice
One short press			
Press and hold			

Item	Function	Default setting	Customized setting
Door lock (→P. 42)	Unlocking using a key	Driver's door unlocked in one step, all doors unlocked in two steps	All doors unlocked in one step.
	Speed-detecting automatic door lock function	Off	On
	Opening driver's door unlocks all doors	Off	On
	Shifting gears to P unlocks all doors. (automatic transmission)	On	Off
	Shifting gears to position other than P locks all doors. (automatic transmission)	On	Off
Automatic light control system (→P. 159)	Light sensor sensitivity	Level 3	Level 1 to 5
	Time elapsed before headlights automatically turn off after doors are closed	30 seconds	0 seconds
			60 seconds
			90 seconds
Lights (→P. 159)	Daytime running light system (U.S.A. only)	On	Off

Item	Function	Default setting	Customized setting
Illumination (→P. 313)	Time elapsed before lights turn off	15 seconds	7.5 seconds 30 seconds
	Operation when the doors are unlocked	On	Off
	Vehicles with smart key system: Operation after the "ENGINE START STOP" switch turned OFF Vehicles without smart key system: Operation after the engine switch turned to the "LOCK" position	On	Off
Seat belt reminder (→P. 435)	Vehicle speed linked seat belt reminder buzzer	On	Off

FarmaSOS.com

## 6-3. Initialization

### Items to initialize

The following items must be initialized for normal system operation in cases such as after the battery is reconnected, or maintenance is performed on the vehicle.

Item	When to initialize	Reference
Engine oil maintenance data (U.S.A. only)	After changing engine oil	P. 371
Tire pressure warning system (U.S.A. only)	When changing the tire inflation pressure by changing traveling speed or load weight, etc.	P. 384

امداد خودرو فارما

تلفن شبانه روزی: ۰۲۱-۸۸۶۲۰۸۵

FarmaSOS.com

## Reporting safety defects for U.S. owners

If you believe that your vehicle has a defect which could cause a crash or could cause injury or death, you should immediately inform the National Highway Traffic Safety Administration (NHTSA) in addition to notifying Toyota Motor Sales, U.S.A., Inc. (Toll-free: 1-800-331-4331).

If NHTSA receives similar complaints, it may open an investigation, and if it finds that a safety defect exists in a group of vehicles, it may order a recall and remedy campaign. However, NHTSA cannot become involved in individual problems between you, your dealer, or Toyota Motor Sales, U.S.A., Inc.

To contact NHTSA, you may call the Vehicle Safety Hotline toll-free at 1-888-327-4236 (TTY: 1-800-424-9153); go to <http://www.safercar.gov>; or write to: Administrator, NHTSA, 1200 New Jersey Ave, S.E., Washington, DC 20590. You can also obtain other information about motor vehicle safety from <http://www.safercar.gov>.

تلفن شبانه روزی: ۰۲۱-۸۸۶۲۰۸۵

FarmaSOS.com

## Seat belt instructions for Canadian owners (in French)

The following is a French explanation of seat belt instructions extracted from the seat belt section in this manual.

See the seat belt section for more detailed seat belt instructions in English.

### Utilisation correcte des ceintures de sécurité

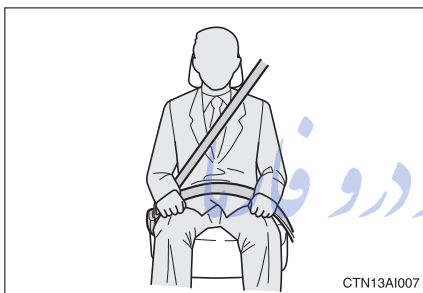

- Tendez la sangle diagonale de sorte qu'elle couvre complètement l'épaule, sans entrer en contact avec le cou ou glisser de l'épaule.
- Placez la sangle abdominale le plus bas possible sur les hanches.
- Réglez la position du dossier de siège. Asseyez-vous le dos le plus droit possible et caliez-vous bien dans le siège.
- Ne vrillez pas la ceinture de sécurité.

## Guide de confort de ceinture de sécurité (siège arrière extérieur)

Si la sangle diagonale gêne la personne au niveau du cou, utilisez le guide confort de la ceinture de sécurité.

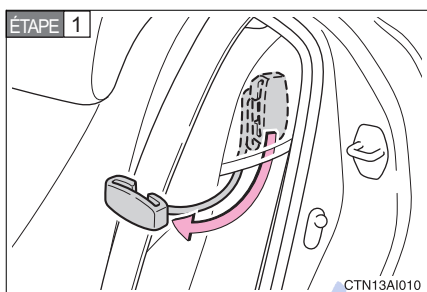

Sortez le guide confort de sa poche.

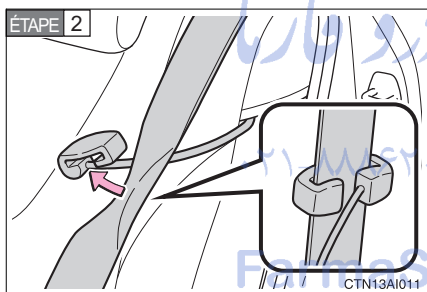

Engagez la ceinture dans le guide.

Le cordon élastique doit passer sous la ceinture de sécurité.

تلفن شبانه روزی: ۰۲۱۸۴۲۰۸۵

FarmasOS.com

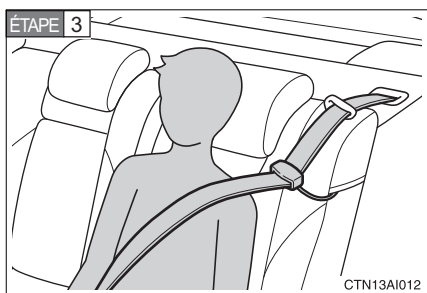

Bouclez, positionnez et lâchez la ceinture de sécurité.

## ■ Ceinture de sécurité arrière

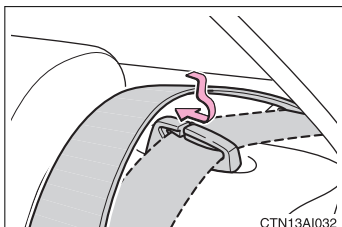

Si la ceinture de sécurité est sortie de son guide, repassez-la dedans avant de l'utiliser.

## Entretien et soin

### ■ Ceintures de sécurité

Nettoyez avec un chiffon ou une éponge humectée d'eau savonneuse tiède. Profitez de l'occasion pour vérifier régulièrement que les ceintures ne sont pas effilochées, entaillées, ou ne paraissent pas exagérément usées.

### ⚠ ATTENTION

### ■ Détérioration et usure des ceintures de sécurité

Inspectez les ceintures de sécurité périodiquement. Contrôlez qu'elles ne sont pas entaillées, effilochées, et que leurs ancrages ne sont pas desserrés. N'utilisez pas une ceinture de sécurité défectueuse avant qu'elle ne soit remplacée. Une ceinture de sécurité défectueuse n'apporte aucune garantie de protection de l'occupant en cas d'accident.



# امداد خودرو فارما

تلفن شبانه روزی: ۰۲۱-۸۸۸۶۲۰۸۵

**FarmaSOS.com**

## Abbreviation list

### Abbreviation/Acronym list

ABBREVIATIONS	MEANING
A/C	Air Conditioning
ABS	Anti-lock Brake System
ACC	Accessory
ALR	Automatic Locking Retractor
CRS	Child Restraint System
DISP	Display
ECU	Electronic Control Unit
EDR	Event data recorder
ELR	Emergency Locking Retractor
GAWR	Gross Axle Weight Ratings
GVWR	Gross Vehicle Weight Rating
I/M	Emission inspection and maintenance
LATCH	Lower Anchors and Tethers for Children
LED	Light Emitting Diode
MMT	Methylcyclopentadienyl Manganese Tricarbonyl
M + S	Mud and Snow
MTBE	Methyl Tertiary Butyl Ether
OBD	On Board Diagnostics
SRS	Supplemental Restraint System
TIN	Tire Identification Number
TPMS	Tire Pressure Warning System
TRAC	Traction Control
VIN	Vehicle Identification Number
VSC	Vehicle Stability Control

## What to do if...

## What to do if...

A tire punctures	P. 454	If you have a flat tire
The engine does not start	P. 465	If the engine will not start
	P. 80	Engine immobilizer system
	P. 471	If the battery is discharged
	P. 469	If the electronic key does not operate properly
The shift lever cannot be moved out	P. 467	If the shift lever cannot be shifted from P
The engine coolant temperature gauge enters the red zone	P. 475	If your vehicle overheats
Steam can be seen coming from under the hood		
The key is lost	P. 468	If you lose your keys
The battery runs out	P. 471	If the battery is discharged
The doors cannot be locked	P. 42	Doors
The horn begins to sound	P. 82	Alarm
The vehicle is stuck in mud or sand	P. 478	If the vehicle becomes stuck

The warning light or indicator light comes on

P. 432

If a warning light turns on or a warning buzzer sounds...

► Vehicles with multi-information display

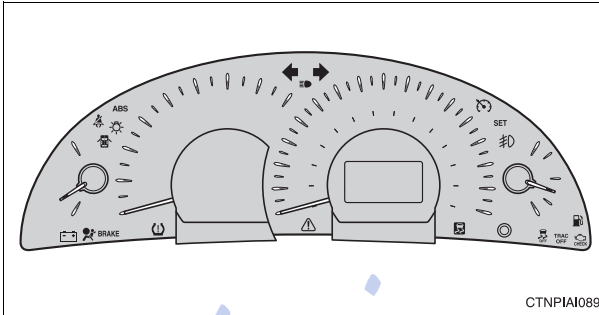

► Vehicles without multi-information display

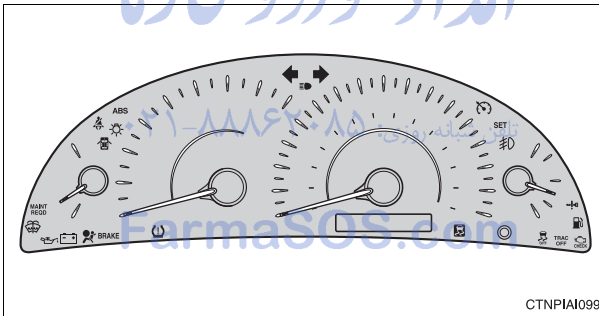

■ Warning lights



Brake system warning light

or



P. 432



Tire pressure warning light

P. 435



Low windshield washer fluid warning light

P. 435



Charging system warning light

P. 433



Open door warning light

P. 435



Low engine oil pressure warning light

P. 433



Low fuel level warning light

P. 435



Malfunction indicator lamp

or



P. 433



Driver's seat belt reminder light

P. 435



Front passenger's seat belt reminder light

P. 435



SRS warning light

P. 433



Master warning light

P. 435



ABS warning light

or



P. 433



Smart key system warning light

P. 438



Engine oil replacement reminder light

P. 435

The warning message is displayed

P. 444

If a warning message is displayed

## GAS STATION INFORMATION

**Auxiliary catch lever**

P. 362

**Trunk opener**

P. 47

**Fuel filler door**

P. 76

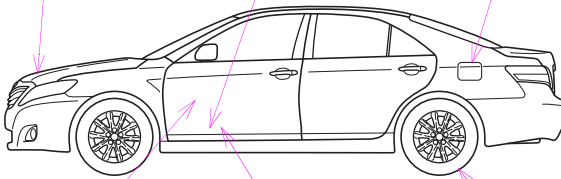

CTNPIA1061

**Hood lock release lever**

P. 362

**Fuel filler door opener**

P. 76

**Tire inflation pressure**

P. 491

Fuel tank capacity		18.5 gal. (70 L, 15.4 Imp. gal.)	
Fuel type		Unleaded gasoline only P. 77, 484	
Cold tire inflation pressure		P. 491	
Engine oil capacity (Drain and refill)	2.5 L 4-cylinder (2AR-FE) engine	With filter	qt. (L, Imp.qt) 4.7 (4.4, 3.9)
		Without filter	4.2 (4.0, 3.5)
	3.5 L V6 (2GR-FE) engine	With filter	6.4 (6.1, 5.4)
		Without filter	6.0 (5.7, 5.0)
Engine oil type		P. 485	