

<b>Pictorial index</b>	Search by illustration	
<b>1 For safety and security</b>	Make sure to read through them	
<b>2 Instrument cluster</b>	How to read the gauges and meters, the variety of warning lights and indicators, etc.	
<b>3 Operation of each component</b>	Opening and closing the doors and windows, adjustment before driving, etc.	
<b>4 Driving</b>	Operations and advice which are necessary for driving	
<b>5 Audio system</b>	Operating the audio system	
<b>6 Interior features</b>	Usage of the interior features, etc.	
<b>7 Maintenance and care</b>	Caring for your vehicle and maintenance procedures	
<b>8 When trouble arises</b>	What to do in case of malfunction or emergency	
<b>9 Vehicle specifications</b>	Vehicle specifications, customizable features, etc.	
<b>Index</b>	Search by symptom	
	Search alphabetically	

For your information .....8  
 Reading this manual.....12  
 How to search .....13  
 Pictorial index.....14

**1 For safety and security**

**1-1. For safe use**  
 Before driving.....34  
 For safety drive .....36  
 Seat belts.....38  
 SRS airbags.....43  
 Airbag manual on-off system .....55  
 Safety information for children .....57  
 Child restraint systems .....58  
 Installing child restraints .....67  
 Exhaust gas precautions .....76

**1-2. Theft deterrent system**  
 Engine immobilizer system .....77

**2 Instrument cluster**

**2. Instrument cluster**  
 Warning lights and indicators .....86  
 Gauges and meters .....92  
 Drive monitor display .....95  
 Multi-information display .....101  
 Fuel consumption information.....112

**3 Operation of each component**

**3-1. Key information**  
 Keys ..... 116

**3-2. Opening, closing and locking the doors**  
 Doors..... 127  
 Trunk ..... 133  
 Smart entry & start system..... 138

**3-3. Adjusting the seats**  
 Front seats ..... 155  
 Rear seats ..... 156  
 Head restraints..... 159

**3-4. Adjusting the steering wheel and mirrors**  
 Steering wheel ..... 161  
 Inside rear view mirror..... 163  
 Outside rear view mirrors..... 166

**3-5. Opening and closing the windows**  
 Power windows ..... 169

## 4 Driving

### 4-1. Before driving

Driving the vehicle .....	174
Cargo and luggage .....	187
Trailer towing .....	188

### 4-2. Driving procedures

Engine (ignition) switch (vehicles without a smart entry & start system) .....	196
Engine (ignition) switch (vehicles with a smart entry & start system) .....	199
Multidrive .....	209
Multi-mode Manual Transmission .....	213
Manual transmission .....	218
Turn signal lever .....	222
Parking brake .....	223

### 4-3. Operating the lights and wipers

Headlight switch .....	224
Fog light switch .....	230
Windshield wipers and washer .....	232

### 4-4. Refueling

Opening the fuel tank cap .....	237
------------------------------------	-----

### 4-5. Toyota Safety Sense

Toyota Safety Sense .....	240
PCS (Pre-Crash Safety system) .....	246
LDA (Lane Departure Alert) .....	259
Automatic High Beam .....	264
RSA (Road Sign Assist) .....	268

### 4-6. Using the driving support systems

Stop & Start system .....	274
Cruise control .....	286
Speed limiter .....	290
Toyota parking assist-sensor .....	293
Simple-IPA (Simple-Intelligent Parking Assist) .....	299
Diesel particulate filter system .....	313
Driving assist systems .....	314
Hill-start assist control .....	321

### 4-7. Driving tips

Winter driving tips .....	323
---------------------------	-----

**5 Interior features**

**5-1. Basic Operations**

- Audio system types.....328
- Steering wheel audio switches.....330
- AUX port/USB port.....331

**5-2. Using the audio system**

- Optimal use of the audio system .....332

**5-3. Using the radio**

- Radio operation .....334

**5-4. Playing audio CDs and MP3/WMA discs**

- CD player operation.....338

**5-5. Using an external device**

- Listening to an iPod .....346
- Listening to a USB memory device .....354
- Using the AUX port.....361

**5-6. Using Bluetooth® devices**

- Bluetooth® audio/phone ..... 362
- Using the steering wheel switches ..... 367
- Registering a Bluetooth® device..... 368

**5-7. “SET UP” menu**

- Using the “SET UP” menu (“Bluetooth” menu)..... 369
- Using the “SET UP” menu (“Phone” menu)..... 374

**5-8. Bluetooth® Audio**

- Operating a Bluetooth® enabled portable player ..... 379

**5-9. Bluetooth® Phone**

- Making a phone call ..... 382
- Receiving a phone call ..... 384
- Speaking on the phone ..... 385

**5-10. Bluetooth®**

- Bluetooth® ..... 387

FarmaSOS.com



**6 Maintenance and care****6-1. Using the air conditioning system and defogger**

- Manual air conditioning system .....392
- Automatic air conditioning system .....399
- Power heater .....409
- Seat heaters .....411

**6-2. Using the interior lights**

- Interior lights list.....413
  - Front interior light/personal lights .....414
  - Vanity lights .....414
  - Rear interior light .....415

**6-3. Using the storage features**

- List of storage features .....416
  - Glove box .....417
  - Console box .....417
  - Bottle holders .....418
  - Cup holders .....419
  - Auxiliary boxes .....420
- Trunk features.....422

**6-4. Other interior features**

- Other interior features .....423
  - Sun visors .....423
  - Vanity mirrors .....423
  - Clock .....423
  - Power outlets .....424
  - Armrest .....425
  - Coat hook .....425
  - Assist grips .....426

**7 When trouble arises****7-1. Maintenance and care**

- Cleaning and protecting the vehicle exterior ..... 428
- Cleaning and protecting the vehicle interior ..... 432

**7-2. Maintenance**

- Maintenance requirements ..... 435

**7-3. Do-it-yourself maintenance**

- Do-it-yourself service precautions ..... 438
- Hood ..... 441
- Positioning a floor jack ..... 443
- Engine compartment ..... 444
- Tires ..... 460
- Tire inflation pressure ..... 473
- Wheels ..... 475
- Air conditioning filter ..... 478
- Wireless remote control/electronic key battery ..... 480
- Checking and replacing fuses ..... 483
- Light bulbs ..... 488

**8 Vehicle specifications**

**8-1. Essential information**

Emergency flashers .....502  
 If your vehicle has to be stopped in an emergency .....503

**8-2. Steps to take in an emergency**

If your vehicle needs to be towed .....505  
 If you think something is wrong .....511  
 Fuel pump shut off system .....512  
 If a warning light turns on or a warning buzzer sounds .....513  
 If a warning message is displayed .....526  
 If you have a flat tire (vehicles with an emergency tire puncture repair kit).....532

If you have a flat tire (vehicles with a spare tire)..... 555  
 If the engine will not start ..... 571  
 If the shift lever cannot be shifted from P ..... 573  
 If the shift lever cannot be shifted ..... 574  
 If the electronic key does not operate properly ..... 575  
 If the vehicle battery is discharged ..... 578  
 If your vehicle overheats ..... 584  
 If you run out of fuel and the engine stalls ..... 587  
 If the vehicle becomes stuck..... 588

FarmaSOS.com

## 9 Vehicle specifications

### 9-1. Specifications

- Maintenance data  
(fuel, oil level, etc.).....592
- Fuel information .....609

### 9-2. Customization

- Customizable features .....611

### 9-3. Initialization

- Items to initialize .....618

## Index

- What to do if...  
(Troubleshooting) .....620
- Alphabetical index .....626

تلفن شبانه روزی: ۰۲۱-۸۸۸۶۲۰۸۵

FarmaSOS.com

## For your information

### Main Owner's Manual

Please note that this manual applies to all models and all equipment, including options. Therefore, you may find some explanations for equipment not installed on your vehicle.

All specifications provided in this manual are current at the time of printing. However, because of the Toyota policy of continual product improvement, we reserve the right to make changes at any time without notice.

Depending on specifications, the vehicle shown in the illustrations may differ from your vehicle in terms of equipment.

### Accessories, spare parts and modification of your Toyota

Both genuine Toyota and a wide variety of other spare parts and accessories for Toyota vehicles are currently available on the market. Should it be determined that any of the genuine Toyota parts or accessories supplied with the vehicle need to be replaced, Toyota recommends that genuine Toyota parts or accessories, be used to replace them. Other parts or accessories of matching quality can also be used. Toyota cannot accept any liability or guarantee spare parts and accessories which are not genuine Toyota products, nor for replacement or installation involving such parts. In addition, damage or performance problems resulting from the use of non-genuine Toyota spare parts or accessories may not be covered under warranty.

FarmaSOS.com

### Installation of an RF-transmitter system

The installation of an RF-transmitter system in your vehicle could affect electronic systems such as:

- Multiport fuel injection system/sequential multiport fuel injection system
- Cruise control system (if equipped)
- Anti-lock brake system
- SRS airbag system
- Seat belt pretensioner system

Be sure to check with any authorized Toyota dealer or repairer, or another duly qualified and equipped professional for precautionary measures or special instructions regarding installation of an RF-transmitter system.

Further information regarding frequency bands, power levels, antenna positions and installation provisions for the installation of RF-transmitters, is available on request at any authorized Toyota dealer or repairer, or another duly qualified and equipped professional.

### Scrapping of your Toyota

The SRS airbag and seat belt pretensioner devices in your Toyota contain explosive chemicals. If the vehicle is scrapped with the airbags and seat belt pretensioners left as they are, this may cause an accident such as fire. Be sure to have the systems of the SRS airbag and seat belt pretensioner removed and disposed of by a qualified service shop or by any authorized Toyota dealer or repairer, or another duly qualified and equipped professional, before you scrap your vehicle.



FarmaSOS.com

Your vehicle contains batteries and/or accumulators. Do not discard them into the environment but cooperate with separate collection (Directive 2006/66/EC).

 WARNING**■ General precautions while driving**

Driving under the influence: Never drive your vehicle when under the influence of alcohol or drugs that have impaired your ability to operate your vehicle. Alcohol and certain drugs delay reaction time, impair judgment and reduce coordination, which could lead to an accident that could result in death or serious injury.

Defensive driving: Always drive defensively. Anticipate mistakes that other drivers or pedestrians might make and be ready to avoid accidents.

Driver distraction: Always give your full attention to driving. Anything that distracts the driver, such as adjusting controls, talking on a cellular phone or reading can result in a collision with resulting death or serious injury to you, your occupants or others.

**■ General precaution regarding children's safety**

Never leave children unattended in the vehicle, and never allow children to have or use the key.

Children may be able to start the vehicle or shift the vehicle into neutral. There is also a danger that children may injure themselves by playing with the windows, or other features of the vehicle. In addition, heat build-up or extremely cold temperatures inside the vehicle can be fatal to children.

تلفن شبانه روزی: ۰۲۱-۸۸۶۲۰۸۵

FarmaSOS.com

# امداد خودرو فارما

تلفن شبانه روزی: ۰۲۱-۸۸۸۶۲۰۸۵

**FarmaSOS.com**

## Reading this manual



### WARNING:

Explains something that, if not obeyed, could cause death or serious injury to people.



### NOTICE:

Explains something that, if not obeyed, could cause damage to or a malfunction in the vehicle or its equipment.



Indicates operating or working procedures. Follow the steps in numerical order.



Indicates the action (pushing, turning, etc.) used to operate switches and other devices.



Indicates the outcome of an operation (e.g. a lid opens).



Indicates the component or position being explained.



Means “Do not”, “Do not do this”, or “Do not let this happen”.

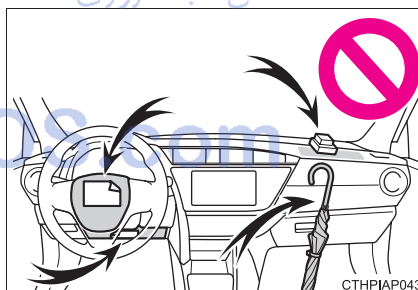
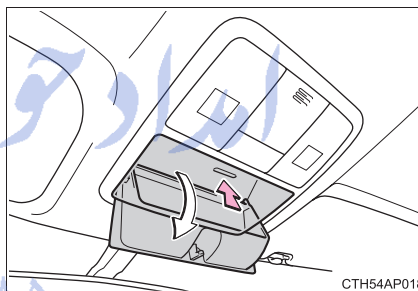



## How to search

### ■ Searching by name

- Alphabetical index ..... P. 626

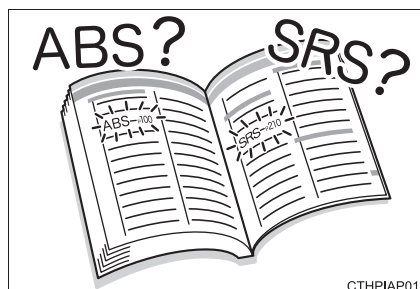

CTHPIAP015

### ■ Searching by installation position

- Pictorial index ..... P. 14



CTHPIAP020

### ■ Searching by symptom or sound

- What to do if...  
(Troubleshooting) ..... P. 620

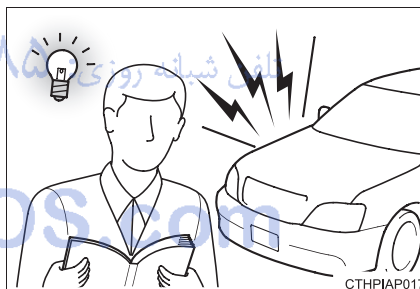

CTHPIAP017

### ■ Searching by title

- Table of contents ..... P. 2

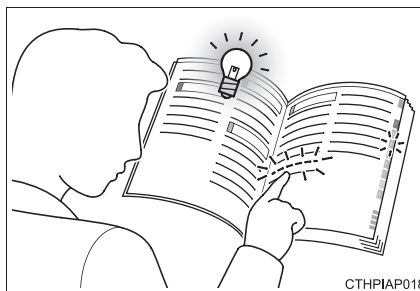

CTHPIAP018

## Pictorial index

### Exterior

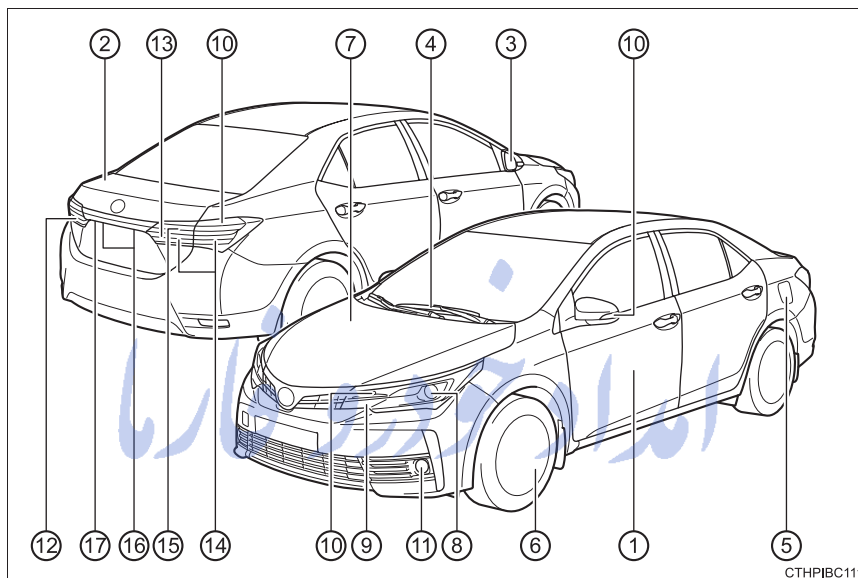

- |   |   |               |
|---|---|---------------|
| ① | <b>Doors</b> .....  | <b>P. 127</b> |
|   | Locking/unlocking .....   | P. 127        |
|   | Opening/closing the door glasses .....                            | P. 169        |
|   | Locking/unlocking by using the mechanical key* <sup>1</sup> ..... | P. 575        |
|   | Warning lights/warning messages* <sup>2</sup> .....               | P. 517, 526   |
| ② | <b>Trunk</b> .....  | <b>P. 133</b> |
|   | Opening from inside .....   | P. 133        |
|   | Opening from outside .....  | P. 133        |
|   | Warning lights/warning messages* <sup>2</sup> .....               | P. 517, 526   |
| ③ | <b>Outside rear view mirrors</b> .....                            | <b>P. 166</b> |
|   | Adjusting the mirror angle .....                                  | P. 166        |
|   | Folding the mirrors .....   | P. 166        |
|   | Defogging the mirrors* <sup>1</sup> .....                         | P. 394, 403   |

- ④ **Windshield wipers** . . . . . **P. 232**  
 Precautions against winter season . . . . . P. 323  
 Precautions against car wash . . . . . P. 430
- ⑤ **Fuel filler door** . . . . . **P. 237**  
 Refueling method . . . . . P. 237  
 Fuel type/fuel tank capacity . . . . . P. 597,609
- ⑥ **Tires** . . . . . **P. 460**  
 Tire size/inflation pressure . . . . . P. 606  
 Winter tires/tire chain . . . . . P. 323  
 Checking/rotation/tire pressure warning system . . . . . P. 460  
 Coping with flat tires . . . . . P. 532, 555
- ⑦ **Hood** . . . . . **P. 441**  
 Opening . . . . . P. 441  
 Engine oil . . . . . P. 598  
 Coping with overheat . . . . . P. 584

#### Light bulbs of the exterior lights for driving

(Replacing method: P. 488, Watts: P. 608)

- ⑧ **Headlights** . . . . . **P. 224**
- ⑨ **Front position lights/daytime running lights** . . . . . **P. 224**
- ⑩ **Turn signal lights** . . . . . **P. 222**
- ⑪ **Front fog lights**<sup>\*1</sup> . . . . . **P. 230**
- ⑫ **Rear fog light (left-hand drive vehicles)** . . . . . **P. 230**
- ⑬ **Rear fog light (right-hand drive vehicles)** . . . . . **P. 230**
- ⑭ **Stop/tail lights** . . . . . **P. 224**  
 Hill-start assist control . . . . . P. 321
- ⑮ **Back-up light**  
 Shifting the shift lever to R. . . . . P. 209, 213, 218
- ⑯ **License plate lights** . . . . . **P. 224**
- ⑰ **Rear view monitor system camera**<sup>\*1, 3</sup>

\*1: If equipped

\*2: Vehicles with a multi-information display

\*3: Refer to "Navigation and multimedia system Owner's manual".

■ Instrument panel (left-hand drive vehicles)

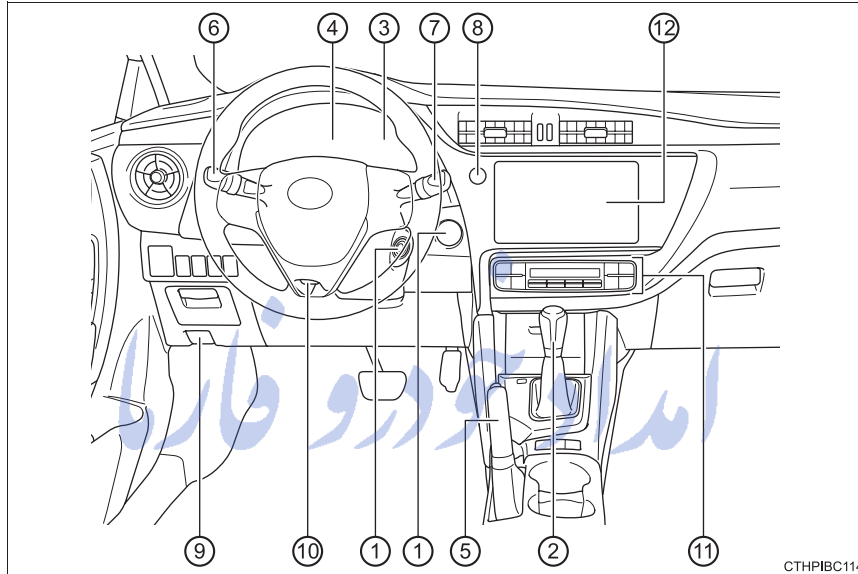

- ① **Engine switch** ..... **P. 196, 199**  
 Starting the engine/changing the position or modes . . . . P. 196, 199  
 Emergency stop of the engine . . . . . P. 503  
 When the engine will not start . . . . . P. 571  
 Warning messages\*2 . . . . . P. 526
- ② **Shift lever** ..... **P. 209, 213, 218**  
 Changing the shift position . . . . . P. 209, 213, 218  
 Precautions against towing . . . . . P. 505  
 When the shift lever does not move\*1 . . . . . P. 573, 574
- ③ **Meters** ..... **P. 92**  
 Reading the meters/adjusting the meter light . . . . . P. 92  
 Warning lights/indicator lights . . . . . P. 86  
 When the warning lights come on . . . . . P. 513

- ④ **Drive monitor display\*1** ..... P. 92  
**Multi-information display\*1** ..... P. 101  
 When the warning messages are displayed ..... P. 526
- ⑤ **Parking brake** ..... P. 223  
 Applying/releasing ..... P. 223  
 Precautions against winter season ..... P. 324  
 Warning buzzer/message\*2 ..... P. 513, 526
- ⑥ **Turn signal lever** ..... P. 222  
**Headlight switch** ..... P. 224  
 Headlights/front position lights/tail lights/  
 daytime running lights ..... P. 224  
 Front fog lights\*1/rear fog light ..... P. 230
- ⑦ **Windshield wiper and washer switch** ..... P. 232  
 Usage ..... P. 232  
 Adding washer fluid ..... P. 457
- ⑧ **Emergency flasher switch** ..... P. 502
- ⑨ **Hood lock release lever** ..... P. 441
- ⑩ **Tilt and telescopic steering lock release lever** ..... P. 161
- ⑪ **Air conditioning system** ..... P. 392, 399  
 Usage ..... P. 392, 399  
 Rear window defogger ..... P. 394, 403
- ⑫ **Audio system\*1** ..... P. 328  
**Navigation/Multimedia system\*1, 3**

\*1: If equipped

\*2: Vehicles with a multi-information display

\*3: Refer to "Navigation and multimedia system Owner's manual".

■ Switches (left-hand drive vehicles)

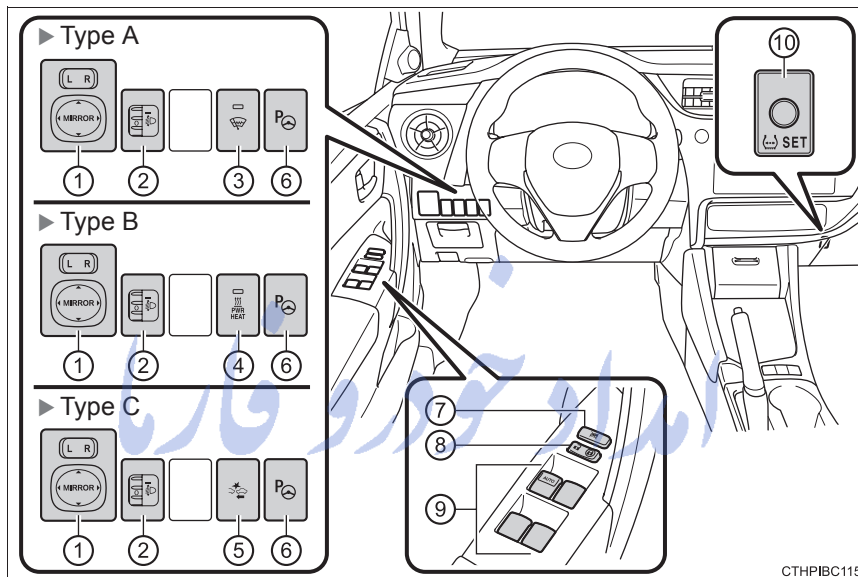

تلفن شبانه روزی: ۰۲۱-۸۸۶۲۰۸۵

FarmaSOS.com

- ① Outside rear view mirror switches . . . . . P. 166
- ② Headlight leveling dial\* . . . . . P. 227
- ③ Windshield wiper de-icer\* . . . . . P. 395, 404
- ④ Power heater switch\* . . . . . P. 409
- ⑤ PCS (Pre-Crash Safety system) switch\* . . . . . P. 246
- ⑥ Simple-IPA switch\* . . . . . P. 300
- ⑦ Window lock switch . . . . . P. 169
- ⑧ Door lock switch . . . . . P. 130
- ⑨ Power window switches\* . . . . . P. 169
- ⑩ Tire pressure warning reset switch . . . . . P. 462

امداد خودرو فارما

تلفن شبانه روزی: ۰۲۱-۸۸۸۶۲۰۸۵

FarmaSOS.com

\*: If equipped

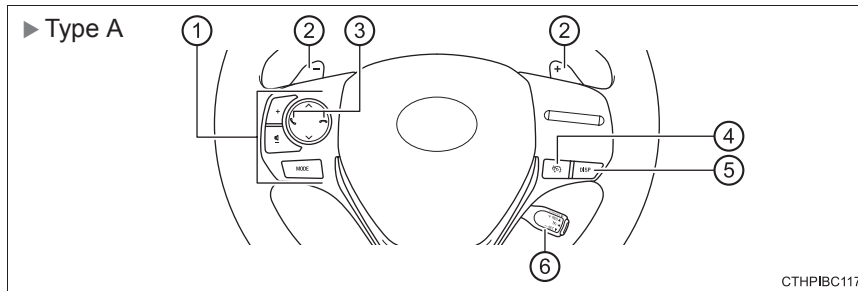

CTHPIBC117

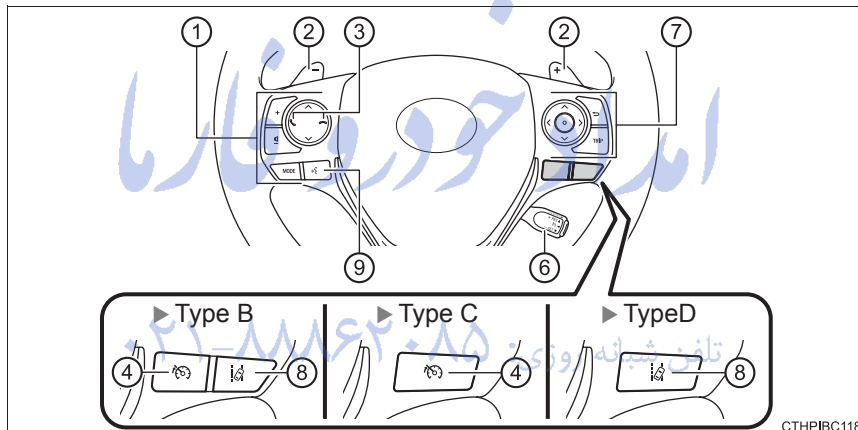

CTHPIBC118

- ① Audio remote control switches\*2 ..... P. 330
- ② Paddle shift switches\*1 ..... P. 214
- ③ Telephone switches\*2 ..... P. 367
- ④ Speed limiter switch\*1 ..... P. 290
- ⑤ “DISP” switch\*1 ..... P. 96
- ⑥ Cruise control switch\*1 ..... P. 286
- ⑦ Meter control switches\*1 ..... P. 103, 104
- ⑧ LDA (Lane Departure Alert) switch\*1 ..... P. 259
- ⑨ Talk switch\*1, 2 ..... P. 367



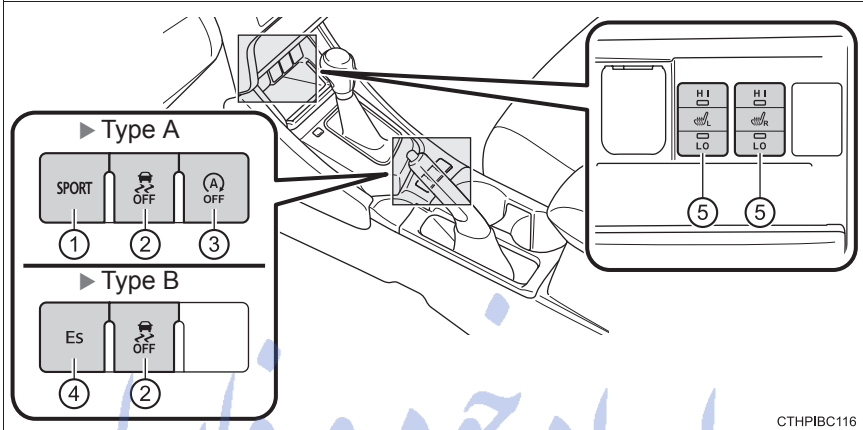

CTHPIBC116

- ① Sport mode switch\*1 ..... P. 210
- ② VSC OFF switch ..... P. 315, 316
- ③ Stop & Start cancel switch\*1 ..... P. 275
- ④ "Es" switch\*1 ..... P. 214
- ⑤ Seat heater switches\*1 ..... P. 411

تلفن شبانه روزی: ۰۸۵۰۶۲۰۸۵-۰۲۱

FarmaSOS.com

\*1: If equipped

\*2: For vehicles with navigation/multimedia system, refer to "Navigation and multimedia system Owner's manual".

### ■ Interior (left-hand drive vehicles)

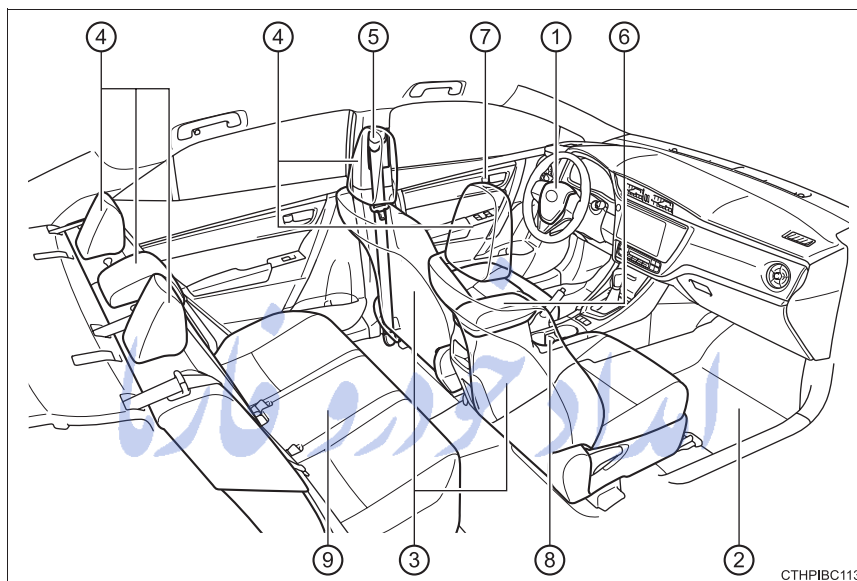

- |                       |       |        |
|-----------------------|-------|--------|
| ① SRS airbags         | ..... | P. 43  |
| ② Floor mats          | ..... | P. 34  |
| ③ Front seats         | ..... | P. 155 |
| ④ Head restraints     | ..... | P. 159 |
| ⑤ Seat belts          | ..... | P. 38  |
| ⑥ Console box         | ..... | P. 417 |
| ⑦ Inside lock buttons | ..... | P. 130 |
| ⑧ Cup holders         | ..... | P. 419 |
| ⑨ Rear seats          | ..... | P. 156 |

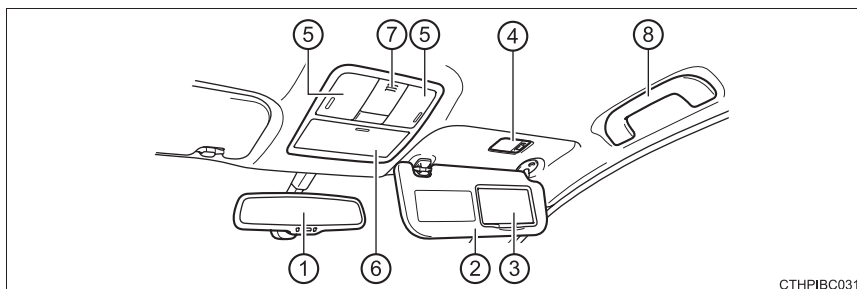

CTHPIBC031

- ① Inside rear view mirror ..... P. 163
- ② Sun visors\*1 ..... P. 423
- ③ Vanity mirrors ..... P. 423
- ④ Vanity lights\*2 ..... P. 414
- ⑤ Interior light/personal lights ..... P. 414, 415
- ⑥ Auxiliary boxes ..... P. 420
- ⑦ Microphone\*2, 3 ..... P. 364
- ⑧ Assist grips ..... P. 426

تلفن شبانه روزی: ۰۲۱-۸۸۶۲۰۸۵

FarmaSOS.com

\*1: NEVER use a rearward facing child restraint on a seat protected by an ACTIVE AIRBAG in front of it, DEATH or SERIOUS INJURY to the CHILD can occur. (→P. 74)



\*2: If equipped

\*3: For vehicles with navigation/multimedia system, refer to "Navigation and multimedia system Owner's manual".

■ Instrument panel (right-hand drive vehicles)

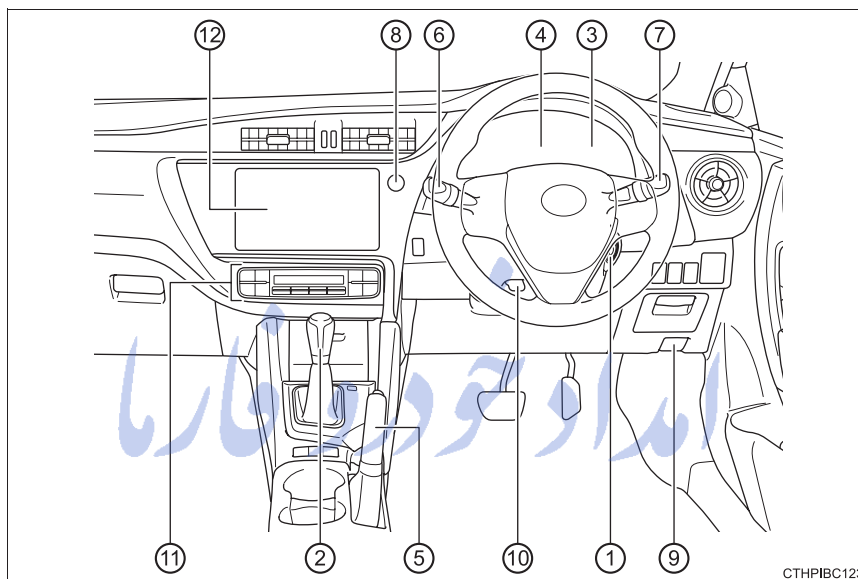

- ① **Engine switch** ..... **P. 196**  
 Starting the engine ..... P. 196  
 Emergency stop of the engine ..... P. 503  
 When the engine will not start ..... P. 571
- ② **Shift lever** ..... **P. 209, 218**  
 Changing the shift position ..... P. 209, 218  
 Precautions against towing ..... P. 505  
 When the shift lever does not move\*1 ..... P. 573
- ③ **Meters** ..... **P. 92**  
 Reading the meters/adjusting the meter light ..... P. 92  
 Warning lights/indicator lights ..... P. 86  
 When the warning lights come on ..... P. 513

- ④ **Drive monitor display\*1** ..... P. 92  
**Multi-information display\*1** ..... P. 101  
 When the warning messages are displayed ..... P. 526
- ⑤ **Parking brake** ..... P. 223  
 Applying/releasing ..... P. 223  
 Precautions against winter season ..... P. 324  
 Warning buzzer/message\*2 ..... P. 513, 526
- ⑥ **Turn signal lever** ..... P. 222  
**Headlight switch** ..... P. 224  
 Headlights/front position lights/tail lights/  
 daytime running lights ..... P. 224  
 Front fog lights\*1/rear fog light ..... P. 230
- ⑦ **Windshield wiper and washer switch** ..... P. 232  
 Usage ..... P. 232  
 Adding washer fluid ..... P. 457
- ⑧ **Emergency flasher switch** ..... P. 502
- ⑨ **Hood lock release lever** ..... P. 441
- ⑩ **Tilt and telescopic steering lock release lever** ..... P. 161
- ⑪ **Air conditioning system** ..... P. 392, 399  
 Usage ..... P. 392, 399  
 Rear window defogger ..... P. 394, 403
- ⑫ **Audio system\*1** ..... P. 328  
**Navigation/Multimedia system\*1, 3**

\*1: If equipped

\*2: Vehicles with a multi-information display

\*3: Refer to "Navigation and multimedia system Owner's manual".

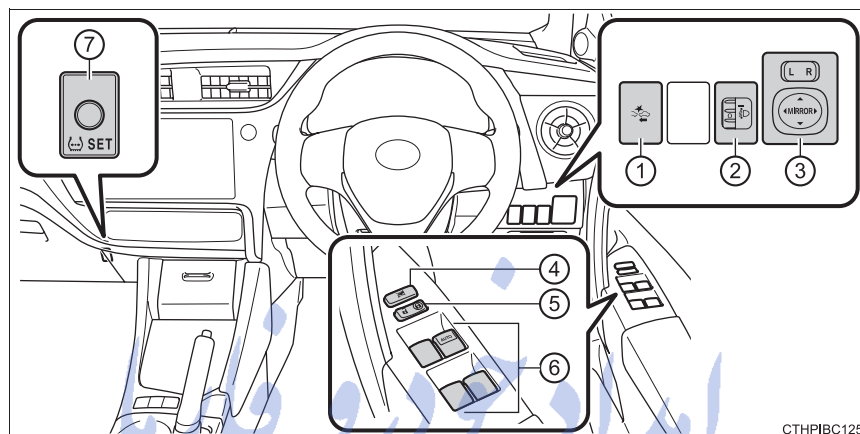
**Switches (right-hand drive vehicles)**

تلفن شبانه روزی: ۰۲۱-۸۸۶۲۰۸۵

FarmaSOS.com

- ① PCS (Pre-Crash Safety system) switch\* ..... P. 246
- ② Headlight leveling dial. .... P. 227
- ③ Outside rear view mirror switches. .... P. 166
- ④ Window lock switch ..... P. 169
- ⑤ Door lock switch ..... P. 130
- ⑥ Power window switches\* ..... P. 169
- ⑦ Tire pressure warning reset switch ..... P. 462

امداد خودرو فارما

تلفن شبانه روزی: ۰۲۱-۸۸۸۶۲۰۸۵

FarmaSOS.com

\*: If equipped

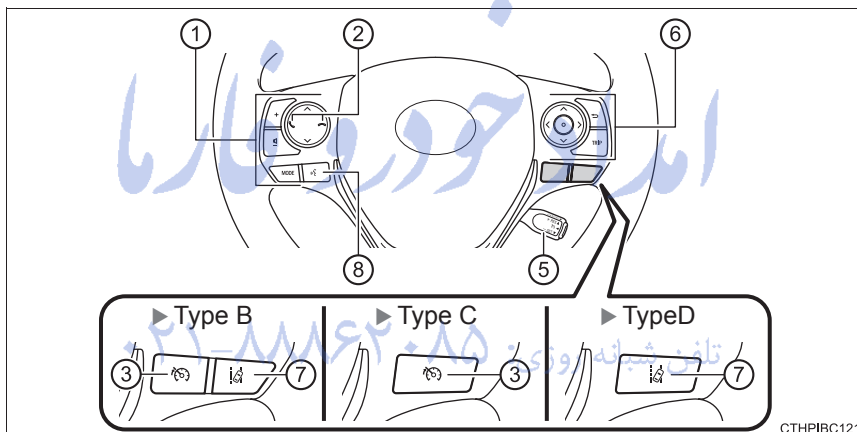
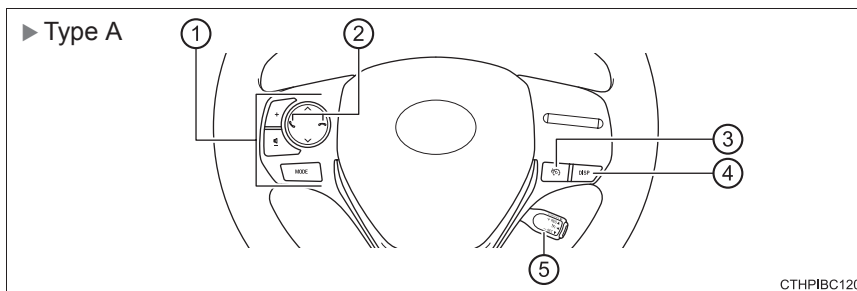

- ① Audio remote control switches\*2 ..... P. 330
- ② Telephone switches\*2 ..... P. 367
- ③ Speed limiter switch\*1 ..... P. 290
- ④ “DISP” switch\*1 ..... P. 96
- ⑤ Cruise control switch\*1 ..... P. 286
- ⑥ Meter control switches\*1 ..... P. 103, 104
- ⑦ LDA (Lane Departure Alert) switch\*1 ..... P. 259
- ⑧ Talk switch\*1, 2 ..... P. 367



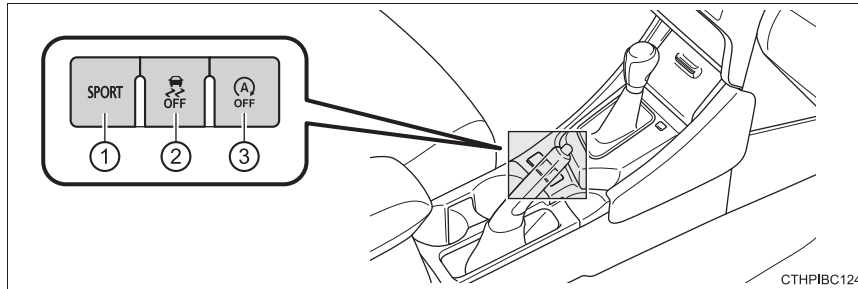

- ① Sport mode switch\*1 ..... P. 210
- ② VSC OFF switch ..... P. 315, 316
- ③ Stop & Start cancel switch\*1 ..... P. 275

تلفن شبانه روزی: ۰۲۱-۸۸۸۶۲۰۸۵

FarmaSOS.com

\*1: If equipped

\*2: For vehicles with navigation/multimedia system, refer to "Navigation and multimedia system Owner's manual".

### ■ Interior (right-hand drive vehicles)

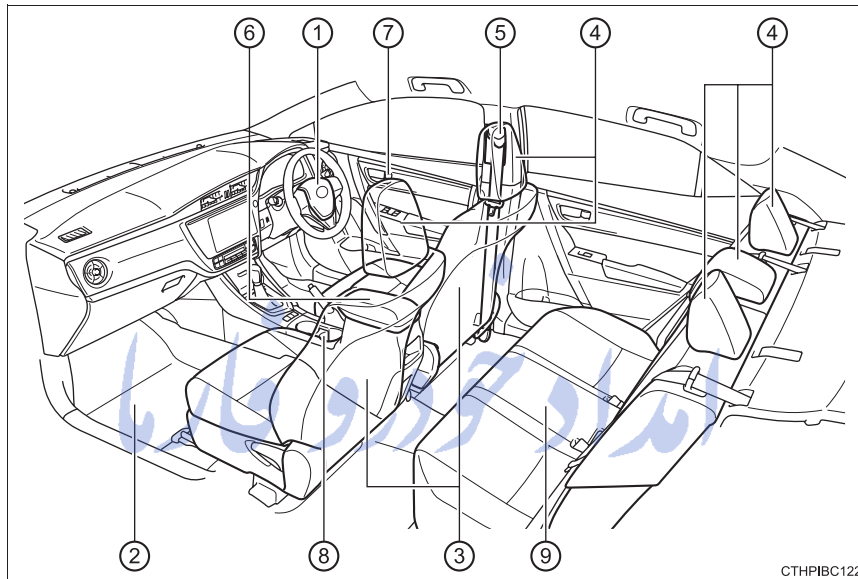

① SRS airbags	.....	P. 43
② Floor mats	.....	P. 34
③ Front seats	.....	P. 155
④ Head restraints	.....	P. 159
⑤ Seat belts	.....	P. 38
⑥ Console box	.....	P. 417
⑦ Inside lock buttons	.....	P. 130
⑧ Cup holders	.....	P. 419
⑨ Rear seats	.....	P. 156

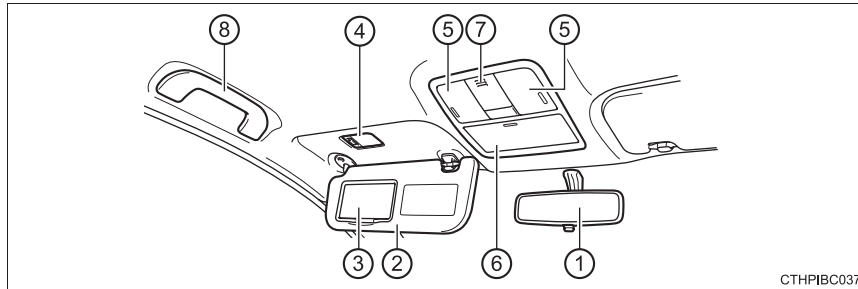

CTHPIBC037

- ① Inside rear view mirror ..... P. 163
- ② Sun visors\*<sup>1</sup> ..... P. 423
- ③ Vanity mirrors ..... P. 423
- ④ Vanity lights\*<sup>2</sup> ..... P. 414
- ⑤ Interior light/personal lights ..... P. 414, 415
- ⑥ Auxiliary boxes ..... P. 420
- ⑦ Microphone\*<sup>2, 3</sup> ..... P. 364
- ⑧ Assist grips ..... P. 426

تلفن شبانه روزی: ۰۲۱-۸۸۶۲۰۸۵

FarmaSOS.com

\*1: NEVER use a rearward facing child restraint on a seat protected by an ACTIVE AIRBAG in front of it, DEATH or SERIOUS INJURY to the CHILD can occur. (→P. 74)



\*2: If equipped

\*3: For vehicles with navigation/multimedia system, refer to "Navigation and multimedia system Owner's manual".

# امداد خودرو فارما

تلفن شبانه روزی: ۰۲۱-۸۸۸۶۲۰۸۵

**FarmaSOS.com**

**For safety and security****1****1-1. For safe use**

Before driving.....	34
For safety drive .....	36
Seat belts.....	38
SRS airbags.....	43
Airbag manual on-off system .....	55
Safety information for children .....	57
Child restraint systems .....	58
Installing child restraints .....	67
Exhaust gas precautions .....	76

**1-2. Theft deterrent system**

Engine immobilizer system .....	77
------------------------------------	----

تلفن شبانه روزی: ۰۲۱-۸۸۸۶۲۰۸۵

**FarmaSOS.com**

## Before driving

### Floor mat

Use only floor mats designed specifically for vehicles of the same model and model year as your vehicle. Fix them securely in place onto the carpet.

- 1 Insert the retaining hooks (clips) into the floor mat eyelets.

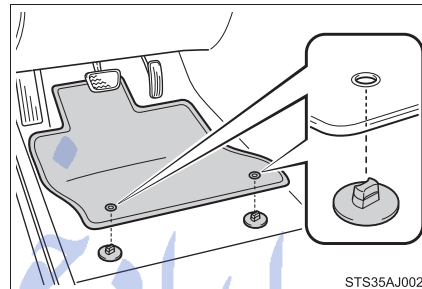

- 2 Turn the upper knob of each retaining hook (clip) to secure the floor mats in place.

\*: Always align the  $\triangle$  marks.

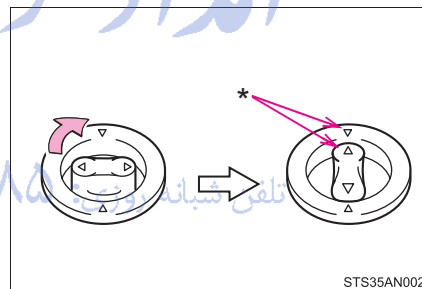

The shape of the retaining hooks (clips) may differ from that shown in the illustration.

**⚠ WARNING**

Observe the following precautions.

Failure to do so may cause the driver's floor mat to slip, possibly interfering with the pedals while driving. An unexpectedly high speed may result or it may become difficult to stop the vehicle. This could lead to an accident, resulting in death or serious injury.

**■ When installing the driver's floor mat**

- Do not use floor mats designed for other models or different model year vehicles, even if they are Toyota Genuine floor mats.
- Only use floor mats designed for the driver's seat.
- Always install the floor mat securely using the retaining hooks (clips) provided.
- Do not use two or more floor mats on top of each other.
- Do not place the floor mat bottom-side up or upside-down.

**■ Before driving**

- Check that the floor mat is securely fixed in the correct place with all the provided retaining hooks (clips). Be especially careful to perform this check after cleaning the floor.
- With the engine stopped and the shift lever in P (Multidrive) or N (multi-mode manual and manual transmissions), fully depress each pedal to the floor to make sure it does not interfere with the floor mat.

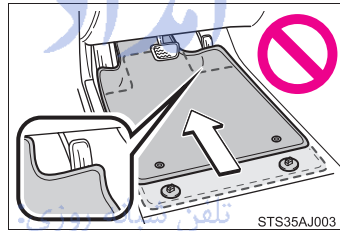

## For safety drive

**For safe driving, adjust the seat and mirror to an appropriate position before driving.**

### Correct driving posture

- ① Adjust the angle of the seat-back so that you are sitting straight up and so that you do not have to lean forward to steer. (→P. 155)
- ② Adjust the seat so that you can depress the pedals fully and so that your arms bend slightly at the elbow when gripping the steering wheel. (→P. 155)
- ③ Lock the head restraint in place with the center of the head restraint closest to the top of your ears. (→P. 159)
- ④ Wear the seat belt correctly. (→P. 38)

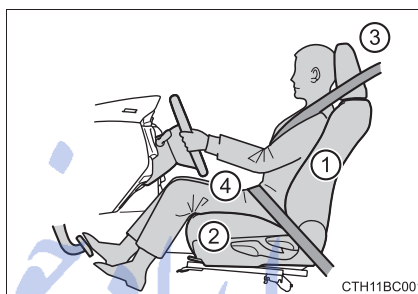

### Correct use of the seat belts

Make sure that all occupants are wearing their seat belts before driving the vehicle. (→P. 38)

Use a child restraint system appropriate for the child until the child becomes large enough to properly wear the vehicle's seat belt. (→P. 58)



### Adjusting the mirrors

Make sure that you can see backward clearly by adjusting the inside and outside rear view mirrors properly. (→P. 163, 166)

#### WARNING

Observe the following precautions.

Failure to do so may result in death or serious injury.

- Do not adjust the position of the driver's seat while driving.  
Doing so could cause the driver to lose control of the vehicle.
- Do not place a cushion between the driver or passenger and the seatback.  
A cushion may prevent correct posture from being achieved, and reduce the effectiveness of the seat belt and head restraint.
- Do not place anything under the front seats.  
Objects placed under the front seats may become jammed in the seat tracks and stop the seat from locking in place. This may lead to an accident and the adjustment mechanism may also be damaged.
- Always observe the legal speed limit when driving on public roads.
- When driving over long distances, take regular breaks before you start to feel tired.  
Also, if you feel tired or sleepy while driving, do not force yourself to continue driving and take a break immediately.
- Take care when adjusting the seat position to ensure that other passengers are not injured by the moving seat.
- When adjusting the seat position, do not put your hands under the seat or near the moving parts to avoid injury. Fingers or hands may become jammed in the seat mechanism.

1

For safety and security

## Seat belts

**Make sure that all occupants are wearing their seat belts before driving the vehicle.**

### Correct use of the seat belts

- Extend the shoulder belt so that it comes fully over the shoulder, but does not come into contact with the neck or slide off the shoulder.
- Position the lap belt as low as possible over the hips.
- Adjust the position of the seat-back. Sit up straight and well back in the seat.
- Do not twist the seat belt.

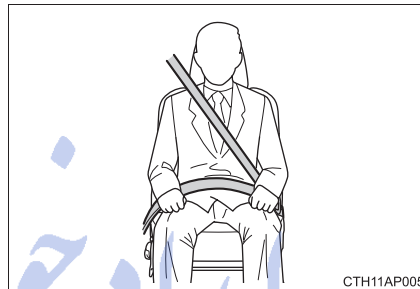

### Fastening and releasing the seat belt

- ① To fasten the seat belt, push the plate into the buckle until a click sound is heard.
- ② To release the seat belt, press the release button.

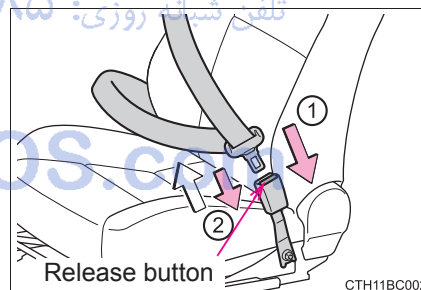

**Adjusting the seat belt shoulder anchor height (front seats)**

- ① Push the seat belt shoulder anchor down while pressing the release button.
- ② Push the seat belt shoulder anchor up.

Move the height adjuster up and down as needed until you hear a click.

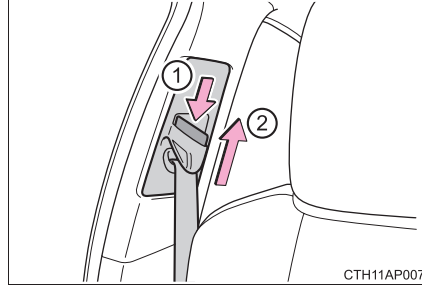
**Seat belt pretensioners (front seats)**

The pretensioners help the seat belts to quickly restrain the occupants by retracting the seat belts when the vehicle is subjected to certain types of severe frontal or side collision.

The pretensioners do not activate in the event of a minor frontal impact, a minor side impact, a rear impact or a vehicle rollover.

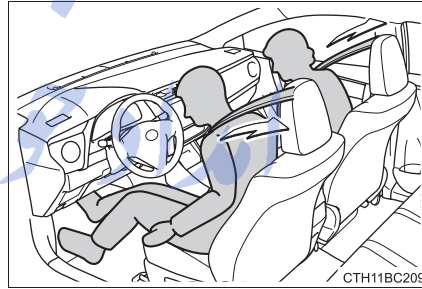

تلفن شبانه روزی: ۰۲۱-۸۸۶۲۰۸۵

FarmaSOS.com

**■ Emergency locking retractor (ELR)**

The retractor will lock the belt during a sudden stop or on impact. It may also lock if you lean forward too quickly. A slow, easy motion will allow the belt to extend so that you can move around fully.

**■ Child seat belt usage**

The seat belts of your vehicle were principally designed for persons of adult size.

- Use a child restraint system appropriate for the child, until the child becomes large enough to properly wear the vehicle's seat belt. (→P. 58)
- When the child becomes large enough to properly wear the vehicle's seat belt, follow the instructions regarding seat belt usage. (→P. 38)

**■ Replacing the belt after the pretensioner has been activated (front seats)**

If the vehicle is involved in multiple collisions, the pretensioner will activate for the first collision, but will not activate for the second or subsequent collisions.

**■ Seat belt regulations**

If seat belt regulations exist in the country where you reside, please contact any authorized Toyota dealer or repairer, or another duly qualified and equipped professional, for seat belt replacement or installation.

تلفن شبانه روزی: ۰۲۱-۸۸۸۶۲۰۸۵

FarmaSOS.com

**⚠ WARNING**

Observe the following precautions to reduce the risk of injury in the event of sudden braking, sudden swerving or an accident. Failure to do so may cause death or serious injury.

■ **Wearing a seat belt**

- Ensure that all passengers wear a seat belt.
- Always wear a seat belt properly.
- Each seat belt should be used by one person only. Do not use a seat belt for more than one person at once, including children.
- Toyota recommends that children be seated in the rear seat and always use a seat belt and/or an appropriate child restraint system.
- To achieve a proper seating position, do not recline the seat more than necessary. The seat belt is most effective when the occupants are sitting up straight and well back in the seats.
- Do not wear the shoulder belt under your arm.
- Always wear your seat belt low and snug across your hips.

■ **Pregnant women**

Obtain medical advice and wear the seat belt in the proper way. (→P. 38)

Women who are pregnant should position the lap belt as low as possible over the hips in the same manner as other occupants, extending the shoulder belt completely over the shoulder and avoiding belt contact with the rounding of the abdominal area.

If the seat belt is not worn properly, not only the pregnant woman, but also the fetus could suffer death or serious injury as a result of sudden braking or a collision.

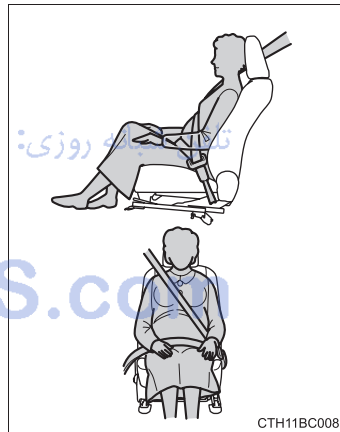

**WARNING****■ People suffering illness**

Obtain medical advice and wear the seat belt in the proper way. (→P. 38)

**■ When children are in the vehicle**

Do not allow children to play with the seat belt. If the seat belt becomes twisted around a child's neck, it may lead to choking or other serious injuries that could result in death.

If this occurs and the buckle cannot be unfastened, scissors should be used to cut the belt.

**■ Seat belt pretensioners (front seats)**

If the pretensioner has activated, the SRS warning light will come on. In that case, the seat belt cannot be used again and must be replaced at any authorized Toyota dealer or repairer, or another duly qualified and equipped professional.

**■ Adjustable shoulder anchor (front seats)**

Always make sure the shoulder belt is positioned across the center of your shoulder. The belt should be kept away from your neck, but not falling off your shoulder. Failure to do so could reduce the amount of protection in an accident and cause death or serious injuries in the event of a sudden stop, sudden swerve or accident. (→P. 39)

**■ Seat belt damage and wear**

- Do not damage the seat belts by allowing the belt, plate, or buckle to be jammed in the door.
- Inspect the seat belt system periodically. Check for cuts, fraying, and loose parts. Do not use a damaged seat belt until it is replaced. Damaged seat belts cannot protect an occupant from death or serious injury.
- Ensure that the belt and plate are locked and the belt is not twisted. If the seat belt does not function correctly, immediately contact any authorized Toyota dealer or repairer, or another duly qualified and equipped professional.
- Replace the seat assembly, including the belts, if your vehicle has been involved in a serious accident, even if there is no obvious damage.
- Do not attempt to install, remove, modify, disassemble or dispose of the seat belts. Have any necessary repairs carried out by any authorized Toyota dealer or repairer, or another duly qualified and equipped professional. Inappropriate handling may lead to incorrect operation.

## SRS airbags

The SRS airbags inflate when the vehicle is subjected to certain types of severe impacts that may cause significant injury to the occupants. They work together with the seat belts to help reduce the risk of death or serious injury.

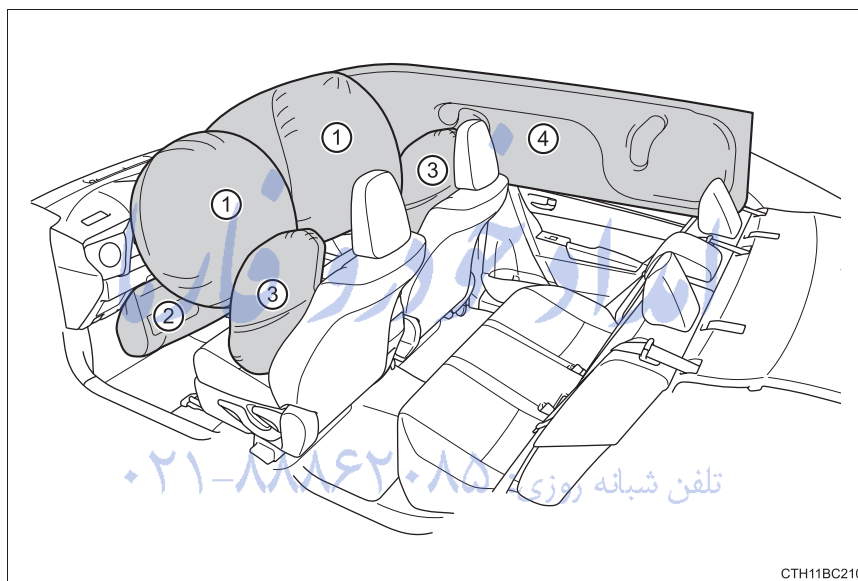

### ◆ SRS front airbags

- ① SRS driver airbag/front passenger airbag  
Can help protect the head and chest of the driver and front passenger from impact with interior components
- ② SRS driver's knee airbag  
Can help provide driver protection

### ◆ SRS side and curtain shield airbags

- ③ SRS front side airbags  
Can help protect the torso of the front seat occupants
- ④ SRS curtain shield airbags  
Can help protect primarily the head of occupants in the outer seats

### SRS airbag system components

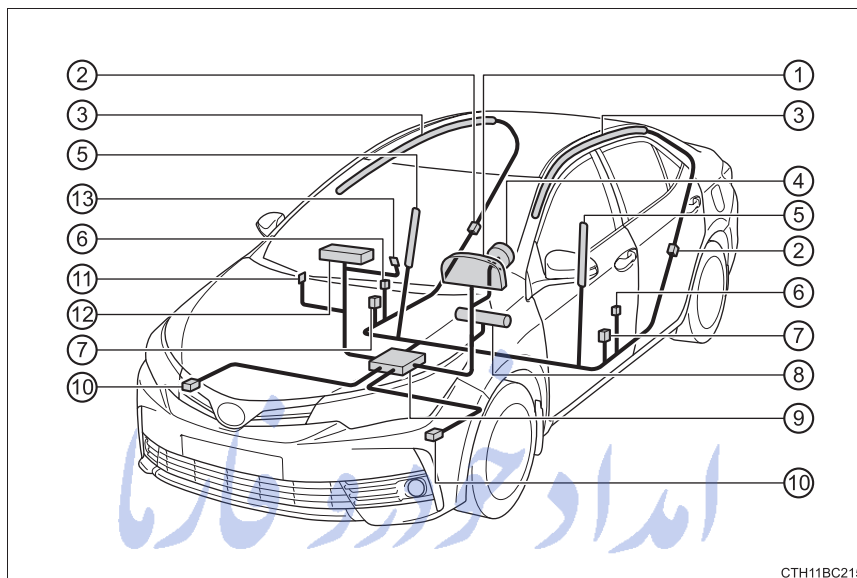

CTH11BC215

- |  |                                 |
|--|---------------------------------|
| ① SRS warning light                          | ⑧ Driver's knee airbag          |
| ② Side impact sensors (rear)                 | ⑨ Airbag sensor assembly        |
| ③ Curtain shield airbags                     | ⑩ Front impact sensors          |
| ④ Driver airbag                              | ⑪ Airbag manual on-off switch   |
| ⑤ Side airbags                               | ⑫ Front passenger airbag        |
| ⑥ Side impact sensors (front)                | ⑬ "PASSENGER AIR BAG" indicator |
| ⑦ Seat belt pretensioners and force limiters |                                 |

The main SRS airbag system components are shown above. The SRS airbag system is controlled by the airbag sensor assembly. As the airbags deploy, a chemical reaction in the inflators quickly fills the airbags with non-toxic gas to help restrain the motion of the occupants.



 WARNING**■ SRS airbag precautions**

Observe the following precautions regarding the SRS airbags. Failure to do so may cause death or serious injury.

- The driver and all passengers in the vehicle must wear their seat belts properly.

The SRS airbags are supplemental devices to be used with the seat belts.

- The SRS driver airbag deploys with considerable force, and can cause death or serious injury especially if the driver is very close to the airbag.

Since the risk zone for the driver's airbag is the first 50 - 75 mm (2 - 3 in.) of inflation, placing yourself 250 mm (10 in.) from your driver airbag provides you with a clear margin of safety. This distance is measured from the center of the steering wheel to your breastbone. If you sit less than 250 mm (10 in.) away now, you can change your driving position in several ways:

- Move your seat to the rear as far as you can while still reaching the pedals comfortably.
  - Slightly recline the back of the seat.
- Although vehicle designs vary, many drivers can achieve the 250 mm (10 in.) distance, even with the driver seat all the way forward, simply by reclining the back of the seat somewhat. If reclining the back of your seat makes it hard to see the road, raise yourself by using a firm, non-slippery cushion, or raise the seat if your vehicle has that feature.
- If your steering wheel is adjustable, tilt it downward. This points the airbag toward your chest instead of your head and neck.

The seat should be adjusted as recommended above, while still maintaining control of the foot pedals, steering wheel, and your view of the instrument panel controls.

- The SRS front passenger airbag also deploys with considerable force, and can cause death or serious injury especially if the front passenger is very close to the airbag. The front passenger seat should be as far from the airbag as possible with the seatback adjusted, so the front passenger sits upright.
- Improperly seated and/or restrained infants and children can be killed or seriously injured by a deploying airbag. An infant or child who is too small to use a seat belt should be properly secured using a child restraint system. Toyota strongly recommends that all infants and children be placed in the rear seats of the vehicle and properly restrained. The rear seats are safer for infants and children than the front passenger seat. (→P. 58)

**⚠ WARNING****■ SRS airbag precautions**

- Do not sit on the edge of the seat or lean against the dashboard.

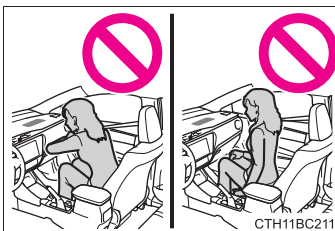

- Do not allow a child to stand in front of the SRS front passenger airbag unit or sit on the knees of a front passenger.
- Do not allow the front seat occupants to hold items on their knees.

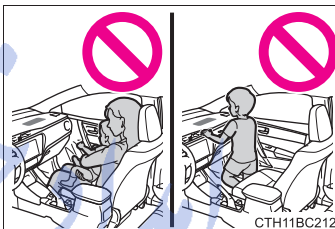

- Do not lean against the door, the roof side rail or the front, side and rear pillars.



- Do not allow anyone to kneel on the passenger seats toward the door or put their head or hands outside the vehicle.

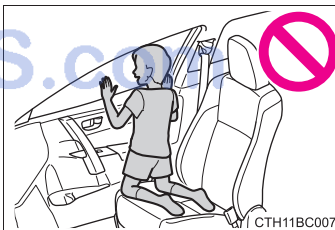

**⚠ WARNING**

■ **SRS airbag precautions**

- Do not attach anything to or lean anything against areas such as the dashboard, steering wheel pad and lower portion of the instrument panel. These items can become projectiles when the SRS driver, front passenger and driver's knee airbag deploy.
- Do not attach anything to areas such as the door, windshield glass, side door glass, front or rear pillar, roof side rail and assist grip. (Except for the speed limit label →P. 540, 545)
- Vehicles without a smart entry & start system: Do not attach any heavy, sharp or hard objects such as keys and accessories to the key. The objects may restrict the SRS driver's knee airbag inflation or be thrust into the driver's seat area by the force of the deploying airbag, thus causing a danger.

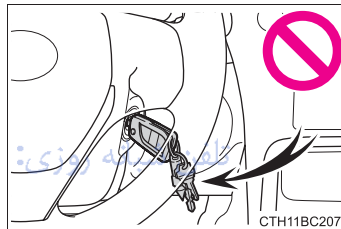
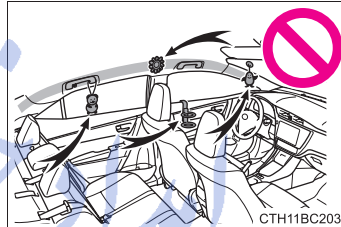
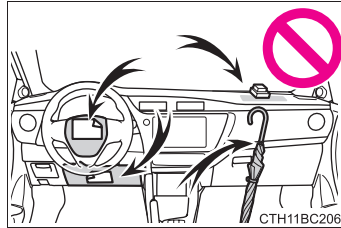

FarmaSOS.com

 WARNING**■ SRS airbag precautions**

- Do not hang coat hangers or other hard objects on the coat hooks. All of these items could become projectiles and may cause death or serious injury, should the SRS curtain shield airbags deploy.
- If a vinyl cover is put on the area where the SRS driver's knee airbag will deploy, be sure to remove it.
- Do not use seat accessories which cover the parts where the SRS side airbags inflate as they may interfere with inflation of the airbags. Such accessories may prevent the side airbags from activating correctly, disable the system or cause the side airbags to inflate accidentally, resulting in death or serious injury.
- Do not strike or apply significant levels of force to the area of the SRS airbag components.  
Doing so can cause the SRS airbags to malfunction.
- Do not touch any of the component parts immediately after the SRS airbags have deployed (inflated) as they may be hot.
- If breathing becomes difficult after the SRS airbags have deployed, open a door or window to allow fresh air in, or leave the vehicle if it is safe to do so. Wash off any residue as soon as possible to prevent skin irritation.
- If the areas where the SRS airbags are stored, such as the steering wheel pad and front and rear pillars garnishes, are damaged or cracked, have them replaced by any authorized Toyota dealer or repairer, or another duly qualified and equipped professional.

FarmaSOS.com

 WARNING**■ Modification and disposal of SRS airbag system components**

Do not dispose of your vehicle or perform any of the following modifications without consulting any authorized Toyota dealer or repairer, or another duly qualified and equipped professional. The SRS airbags may malfunction or deploy (inflate) accidentally, causing death or serious injury.

- Installation, removal, disassembly and repair of the SRS airbags
- Repairs, modifications, removal or replacement of the steering wheel, instrument panel, dashboard, seats or seat upholstery, front, side and rear pillars or roof side rails
- Repairs or modifications of the front fender, front bumper, or side of the occupant compartment
- Installation of a grille guard (bull bars, kangaroo bar, etc.), snow plows, winches
- Modifications to the vehicle's suspension system
- Installation of electronic devices such as an RF-transmitter and CD players
- Modifications to your vehicle for a person with a physical disability

تلفن شبانه روزی: ۰۲۱-۸۸۶۲۰۸۵

FarmaSOS.com

1

For safety and security

**■ If the SRS airbags deploy (inflate)**

- Slight abrasions, burns, bruising etc., may be sustained from SRS airbags, due to the extremely high speed deployment (inflation) by hot gases.
- A loud noise and white powder will be emitted.
- Parts of the airbag module (steering wheel hub, airbag cover and inflator) as well as the front seats, parts of the front and rear pillars, and roof side rails, may be hot for several minutes. The airbag itself may also be hot.
- The windshield may crack.

**■ SRS airbag deployment conditions (SRS front airbags)**

- The SRS front airbags will deploy in the event of an impact that exceeds the set threshold level (the level of force corresponding to an approximately 20 - 30 km/h [12 - 18 mph] frontal collision with a fixed wall that does not move or deform).

However, this threshold velocity will be considerably higher in the following situations:

- If the vehicle strikes an object, such as a parked vehicle or sign pole, which can move or deform on impact
  - If the vehicle is involved in an underride collision, such as a collision in which the front of the vehicle “underrides”, or goes under, the bed of a truck
- Depending on the type of collision, it is possible that only the seat belt pretensioners will activate.

**■ SRS airbag deployment conditions (SRS side and curtain shield airbags)**

- The SRS side and curtain shield airbags will deploy in the event of an impact that exceeds the set threshold level (the level of force corresponding to the impact force produced by an approximately 1500 kg [3300 lb.] vehicle colliding with the vehicle cabin from a direction perpendicular to the vehicle orientation at an approximate speed of 20 - 30 km/h [12 - 18 mph]).
- The SRS curtain shield airbags will deploy in the event of a severe frontal collision.

### ■ Conditions under which the SRS airbags may deploy (inflate), other than a collision

The SRS front airbags and SRS curtain shield airbags may also deploy if a serious impact occurs to the underside of your vehicle. Some examples are shown in the illustration.

- Hitting a curb, edge of pavement or hard surface
- Falling into or jumping over a deep hole
- Landing hard or falling

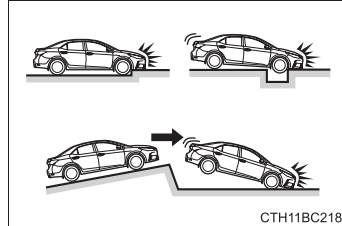

### ■ Types of collisions that may not deploy the SRS airbags (SRS front airbags)

The SRS front airbags do not generally inflate if the vehicle is involved in a side or rear collision, if it rolls over, or if it is involved in a low-speed frontal collision. But, whenever a collision of any type causes sufficient forward deceleration of the vehicle, deployment of the SRS front airbags may occur.

- Collision from the side
- Collision from the rear
- Vehicle rollover

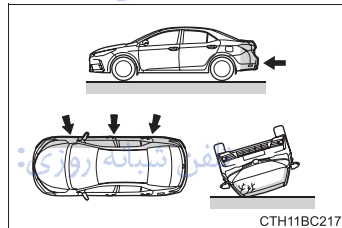

۰۲۱-۸۸۶۲۰۸۵ : تلفن شایانه زواری

FarmaSOS.com

### ■ Types of collisions that may not deploy the SRS airbags (SRS side and curtain shield airbags)

The SRS side and curtain shield airbags may not activate if the vehicle is subjected to a collision from the side at certain angles, or a collision to the side of the vehicle body other than the passenger compartment.

- Collision from the side to the vehicle body other than the passenger compartment
- Collision from the side at an angle

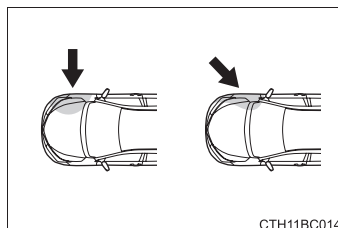

The SRS side airbags do not generally inflate if the vehicle is involved in a frontal or rear collision, if it rolls over, or if it is involved in a low-speed side collision.

- Collision from the front
- Collision from the rear
- Vehicle rollover

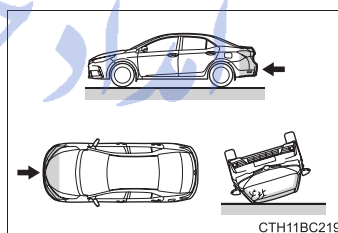

The SRS curtain shield airbags do not generally inflate if the vehicle is involved in a rear collision, if it rolls over, or if it is involved in a low-speed side or low-speed frontal collision.

- Collision from the rear
- Vehicle rollover

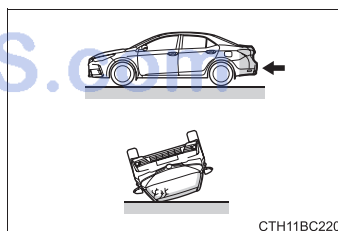



■ **When to contact any authorized Toyota dealer or repairer, or another duly qualified and equipped professional**

In the following cases, the vehicle will require inspection and/or repair. Contact any authorized Toyota dealer or repairer, or another duly qualified and equipped professional as soon as possible.

- Any of the SRS airbags have been inflated.
- The front of the vehicle is damaged or deformed, or was involved in an accident that was not severe enough to cause the SRS front airbags to inflate.

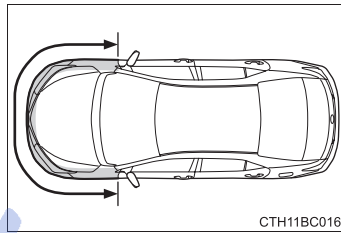

- A portion of a door is damaged or deformed, or the vehicle was involved in an accident that was not severe enough to cause the SRS side airbags and curtain shield airbags to inflate.

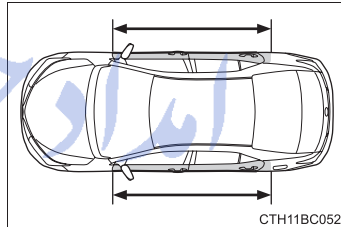

- The pad section of the steering wheel, dashboard near the front passenger airbag or lower portion of the instrument panel is scratched, cracked, or otherwise damaged.

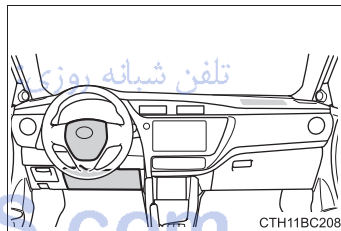

- The surface of the seats with the side airbag is scratched, cracked, or otherwise damaged.

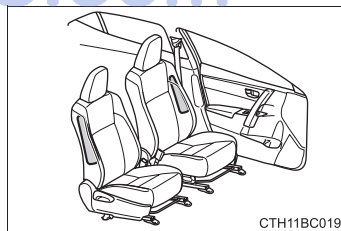

- The portion of the front pillars, rear pillars or roof side rail garnishes (padding) containing the curtain shield airbags inside is scratched, cracked, or otherwise damaged.

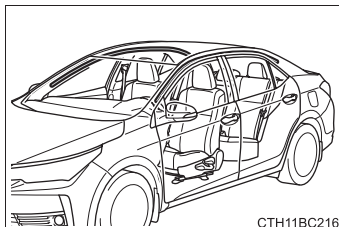

امداد خودرو فارما

تلفن شبانه روزی: ۰۲۱-۸۸۸۶۲۰۸۵

FarmaSOS.com

## Airbag manual on-off system

**This system deactivates the front passenger airbag.  
Only deactivate the airbag when using a child restraint system  
on the front passenger seat.**

### ① "PASSENGER AIR BAG" indicator

Vehicles without a smart entry & start system: The "PASSENGER AIR BAG" and "ON" indicator light turns on when the airbag system is on (Only when the engine switch is in the "ON" position).

Vehicles with a smart entry & start system: The "PASSENGER AIR BAG" and "ON" indicator light turns on when the airbag system is on (Only when the engine switch is in IGNITION ON mode).

### ② Airbag manual on-off switch

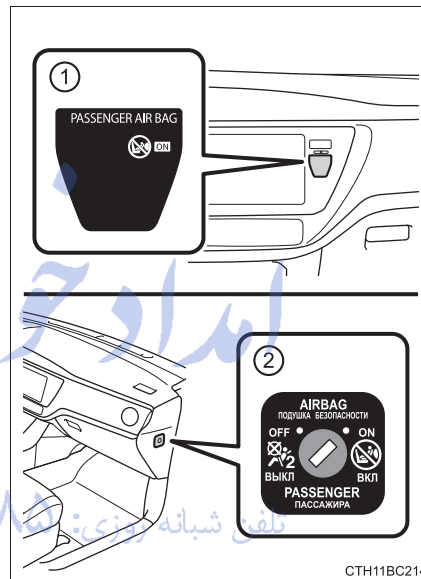

CTH11BC214

FarmaSOS.com

1

For safety and security

### Deactivating the front seat passenger airbag

Vehicles without a smart entry & start system: Insert the key into the cylinder and turn it to the "OFF" position.

The "OFF" indicator light turns on (only when the engine switch is in the "ON" position).

Vehicles with a smart entry & start system: Insert the mechanical key into the cylinder and turn it to the "OFF" position.

The "OFF" indicator light turns on (only when the engine switch is in IGNITION ON mode).

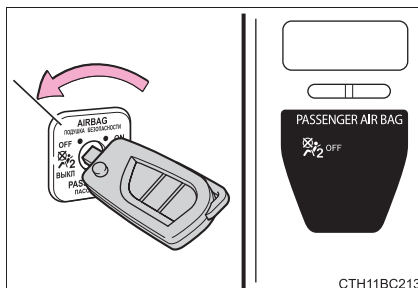

#### ■ "PASSENGER AIR BAG" indicator information

If any of the following problems occur, it is possible that there is a malfunction in the system. Have the vehicle inspected by any authorized Toyota dealer or repairer, or another duly qualified and equipped professional.

- Neither "ON" nor "OFF" comes on.
- The indicator light does not change when the airbag manual on-off switch is switched to "ON" or "OFF".

#### ⚠ WARNING

##### ■ When installing a child restraint system

For safety reasons, always install a child restraint system in a rear seat. In the event that the rear seat cannot be used, the front seat can be used as long as the airbag manual on-off system is set to off. If the airbag manual on-off system is left on, the strong impact of the airbag deployment (inflation) may cause serious injury or even death.

##### ■ When a child restraint system is not installed on the front passenger seat

Ensure that the airbag manual on-off system is set to on. If it is left off, the airbag may not deploy in the event of an accident, which may result in serious injury or even death.

## Safety information for children

Observe the following precautions when children are in the vehicle.

Use a child restraint system appropriate for the child, until the child becomes large enough to properly wear the vehicle's seat belt.

- It is recommended that children sit in the rear seats to avoid accidental contact with the shift lever, wiper switch etc.
- Use the rear door child-protector lock or the window lock switch to avoid children opening the door while driving or operating the power window accidentally.
- Do not let small children operate equipment which may catch or pinch body parts, such as the power window, hood, trunk, seats etc.

### WARNING

Never leave children unattended in the vehicle, and never allow children to have or use the key.

Children may be able to start the vehicle or shift the vehicle into neutral. There is also a danger that children may injure themselves by playing with the windows or other features of the vehicle. In addition, heat build-up or extremely cold temperatures inside the vehicle can be fatal to children.

FarmaSOS.com

## Child restraint systems

**Toyota strongly urges the use of child restraint systems.**

### Points to remember

Studies have shown that installing a child restraint on a rear seat is much safer than installing one on the front passenger seat.

- Choose a child restraint system that suits your vehicle and is appropriate to the age and size of the child.
- For installation details, follow the instructions provided with the child restraint system.

General installation instructions are provided in this manual.

(→P. 67)

- If child restraint system regulations exist in the country where you reside, please contact any authorized Toyota dealer or repairer, or another duly qualified and equipped professional for the child restraint system installation.
- Toyota recommends that you use a child restraint system which conforms to the regulation ECE No.44.

FarmaSOS.com

### Types of child restraints

Child restraint systems are classified into the following 5 groups according to the regulation ECE No.44:

Group 0: Up to 10 kg (22 lb.) (0 - 9 months)

Group 0<sup>+</sup>: Up to 13 kg (28 lb.) (0 - 2 years)

Group I: 9 to 18 kg (20 to 39 lb.) (9 months - 4 years)

Group II: 15 to 25 kg (34 to 55 lb.) (4 years - 7 years)

Group III: 22 to 36 kg (49 to 79 lb.) (6 years - 12 years)

In this owner's manual, the following 3 types of popular child restraint systems that can be secured with the seat belts are explained:

► Baby seat

Equal to Group 0 and 0<sup>+</sup> of ECE No.44

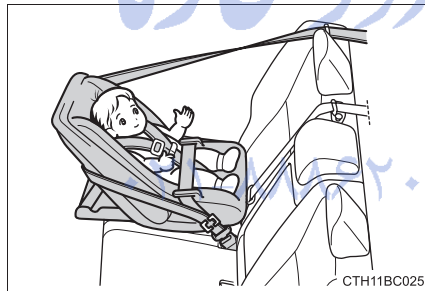

CTH11BC025

► Child seat

Equal to Group 0<sup>+</sup> and I of ECE No.44

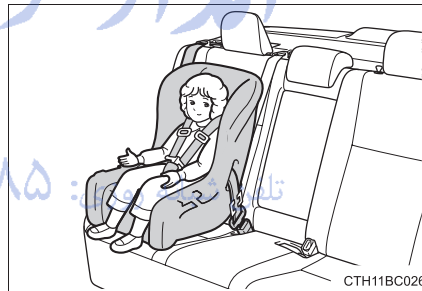

CTH11BC026

► Junior seat

Equal to Group II and III of ECE No.44

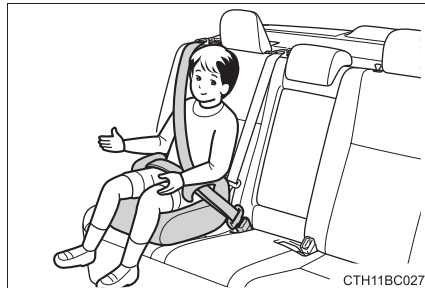

CTH11BC027

### Child restraint system suitability for various seating positions

Information provided in the table shows your child restraint system suitability for various seating positions.

Seating position Mass groups	Front passenger seat		Rear seat	
	Airbag manual on-off switch		Outboard	Center
	ON	OFF		
0 Up to 10 kg (22 lb.) (0 - 9 months)	X Never put	U*1 L1*1	U L1	X
0+ Up to 13 kg (28 lb.) (0 - 2 years)	X Never put	U*1 L1*1	U L1	X
I 9 to 18 kg (20 to 39 lb.) (9 months - 4 years)	Rear-facing — X Never put	U*1	U*2	X
	Forward-facing — UF*1			
II, III 15 to 36 kg (34 to 79 lb.) (4 - 12 years)	UF*1	U*1	U*2 L2*2	X

FarmaSOS.com



Key of letters inserted in the above table:

- U: Suitable for “universal” category child restraint system approved for the use in this mass group.
- UF: Suitable for forward-facing “universal” category child restraint system approved for the use in this mass group.
- L1: Suitable for “TOYOTA G 0<sup>+</sup>, BABY SAFE PLUS with SEAT BELT FIXATION, BASE PLATFORM” (0 to 13 kg [0 to 28 lb.]) approved for the use in this mass group.
- L2: Suitable for “TOYOTA KIDFIX” (15 to 36 kg [34 to 79 lb.]) approved for the use in this mass group.
- X: Not suitable seat position for children in this mass group.

\*1: Adjust the front seatback to the most upright position. Move the front seat cushion to the fully rearward.

Remove the head restraint if it interferes with your child restraint system.

Follow these procedures

- For installing a baby seat with support base  
If the baby seat interferes with the seatback when latching the baby seat into the support base, adjust the seatback rearward until there is no interference.
- For installing a forward-facing child seat  
If the seat belt shoulder anchor is ahead of the child seat belt guide, move the seat cushion forward.
- For installing a junior seat  
If the child in your child restraint system is in a very upright position, adjust the seatback to the most comfortable position.  
If the seat belt shoulder anchor is ahead of the child seat belt guide, move the seat cushion forward.

\*2: Remove the head restraint if it interferes with your child restraint system.

The child restraint system mentioned in the table may not be available outside of the EU area.

Other child restraint system which is different from the system mentioned in the table can be used, but the suitability of the systems must be carefully checked with the child restraint system manufacturer concerned and the seller of those seats.

### Child restraint system suitability for various seating positions (with ISOFIX rigid anchors)

Information provided in the table shows your child restraint system suitability for various seating positions.

Mass groups	Size class	Fixture	Vehicle ISOFIX positions	Recommended Child Restraint Systems
			Rear outboard	
Carycot	F	ISO/L1	X	-
	G	ISO/L2	X	-
		(1)	X	-
0 Up to 10 kg (22 lb.) (0 - 9 months)	E	ISO/R1	IL	"TOYOTA MINI", "TOYOTA MIDI"
		(1)	X	-
0+ Up to 13 kg (28 lb.) (0 - 2 years)	E	ISO/R1	IL	"TOYOTA MINI", "TOYOTA MIDI"
	D	ISO/R2	IL	
	C	ISO/R3	IL	
		(1)	X	-
I 9 to 18 kg (20 to 39 lb.) (9 months - 4 years)	D	ISO/R2	IL	-
	C	ISO/R3	IL	
	B	ISO/F2	IUF*, IL*	"TOYOTA MIDI"
	B1	ISO/F2X	IUF*, IL*	"TOYOTA MIDI", "TOYOTA DUO+"
	A	ISO/F3	IUF*, IL*	"TOYOTA MIDI"
		(1)	X	-
II, III 15 to 36 kg (34 to 79 lb.) (4 - 12 years)		(1)	X	-

- (1) For the child restraint system which do not carry the ISO/XX size class identification (A to G), for the applicable mass group, the car manufacturer shall indicate the vehicle specific ISOFIX child restraint system(s) recommended for each position.

Key of letters inserted in the above table:

IUF: Suitable for ISOFIX forward-facing child restraint systems of universal category approved for use in this mass group.

IL: Suitable for ISOFIX child restraint systems of the categories for “specific vehicles”, “restricted”, or “semi-universal”, approved for use in this mass group.

X: ISOFIX position not suitable for ISOFIX child restraint systems in this mass group and/or this size class.

\*: Remove the head restraint if it interferes with your child restraint system.

When using a “TOYOTA MINI” or “TOYOTA MIDI”, adjust the support leg and the ISOFIX connectors as follows:

- ① Lock the support leg where 5th or 6th hole can be seen.
- ② Lock the ISOFIX connectors where numbers 4 and 5 can be seen.

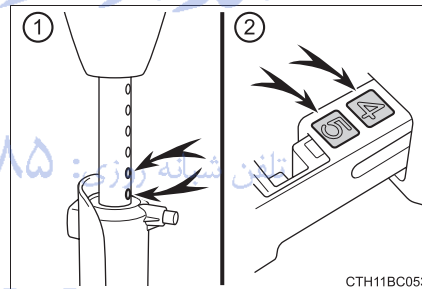

When using the right side seat for the child restraint system, do not sit in the center seat.

The child restraint system mentioned in the table may not be available outside of the EU area.

Other child restraint systems different from the systems mentioned in the table can be used, but the suitability of the systems must be carefully checked with the child restraint system manufacturer and retailer.

### ■ When installing a child restraint system on the front passenger seat

When you have to use a child restraint system on the front passenger seat, adjust the following:

- The seatback to the most upright position.

If the child restraint system interferes with the seatback when latching the child restraint system into the support base, adjust the seatback rearward until there is no interference.

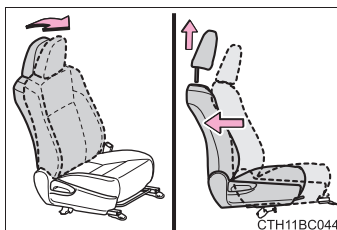

- Remove the head restraint.
- Move the seat as far back as possible.

If the CRS cannot be installed properly, due to hitting part of the vehicle interior and so forth, adjust the position of the front seat and its seatback angle.

If the seat belt shoulder anchor is ahead of the child seat belt guide, move the seat cushion forward.

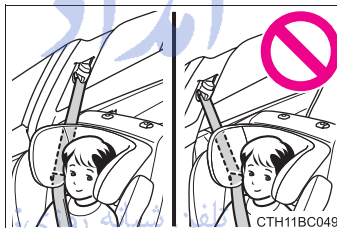

### ■ Selecting an appropriate child restraint system

- Use a child restraint system appropriate for the child until the child becomes large enough to properly wear the vehicle's seat belt.
- If the child is too large for a child restraint system, sit the child on a rear seat and use the vehicle's seat belt. (→P. 38)

 **WARNING****■ Using a child restraint system**

The use of a child restraint system not suitable for the vehicle may not properly secure the infant or child. It may result in death or serious injury (in the event of sudden braking or an accident).

**■ Child restraint precautions**

- For effective protection in automobile accidents and sudden stops, a child must be properly restrained, using a seat belt or child restraint system depending on the age and size of the child. Holding a child in your arms is not a substitute for a child restraint system. In an accident, the child can be crushed against the windshield, or between you and the vehicle's interior.
- Toyota strongly urges the use of a proper child restraint system that conforms to the size of the child, installed on the rear seat. According to accident statistics, the child is safer when properly restrained in the rear seat than in the front seat.
- Never use a rear-facing child restraint system on the front passenger seat when the airbag manual on-off switch is on. (→P. 55)  
In the event of an accident, the force of the rapid inflation of the front passenger airbag can cause death or serious injury to the child.
- A forward-facing child restraint system may be installed on the front passenger seat only when it is unavoidable. A child restraint system that requires a top strap should not be used in the front passenger seat since there is no top strap anchor for the front passenger seat. Adjust the seat-back as upright as possible and always move the seat as far back as possible because the front passenger airbag could inflate with considerable speed and force. Otherwise, the child may be killed or seriously injured.
- Do not allow the child to lean his/her head or any part of his/her body against the door or the area of the seat, front and rear pillars or roof side rails from which the SRS side airbags or SRS curtain shield airbags deploy even if the child is seated in the child restraint system. It is dangerous if the SRS side airbags and curtain shield airbags inflate, and the impact could cause death or serious injury to the child.

 WARNING**■ Child restraint precautions**

- Make sure you have complied with all installation instructions provided by the child restraint manufacturer and that the system is properly secured. If it is not secured properly, it may cause death or serious injury to the child in the event of a sudden stop or accident.

**■ When children are in the vehicle**

Do not allow children to play with the seat belt. If the seat belt becomes twisted around a child's neck, it may lead to choking or other serious injuries that could result in death.

If this occurs and the buckle cannot be unfastened, scissors should be used to cut the belt.

**■ When the child restraint system is not in use**

- Keep the child restraint system properly secured on the seat even if it is not in use. Do not store the child restraint system unsecured in the passenger compartment.
- If it is necessary to detach the child restraint system, remove it from the vehicle or store it securely in the trunk. If a head restraint was removed when installing a child restraint system, always install the head restraint before driving. This will prevent it from injuring passengers in the event of a sudden stop or accident.

تلفن شبانه روزی: ۰۲۱-۸۸۶۲۰۸۵

FarmaSOS.com

## Installing child restraints

Follow the child restraint system manufacturer's instructions. Firmly secure child restraints to the seats using a seat belt or ISOFIX rigid anchors. Attach the top strap when installing a child restraint.

Seat belts (An ELR belt requires a locking clip)

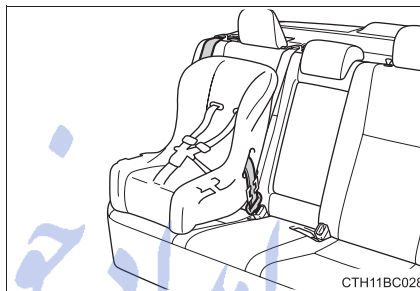

ISOFIX rigid anchors (ISOFIX child restraint system)

Lower anchors are provided for the outboard rear seats. (Labels displaying the location of the anchors are attached to the seats.)

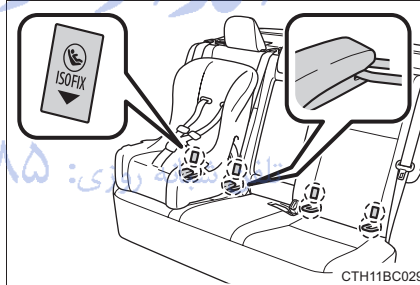

Anchor brackets (for top strap)

An anchor bracket is provided for each outer rear seat.

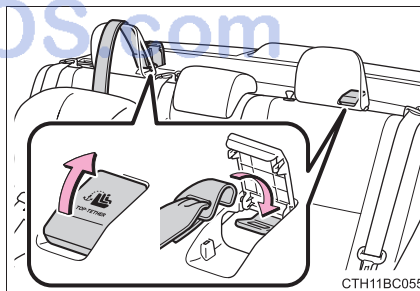

**Installing child restraints using a seat belt****■ Rear-facing — Baby seat/child seat**

- 1 Place the child restraint system on the rear seat facing the rear of the vehicle.

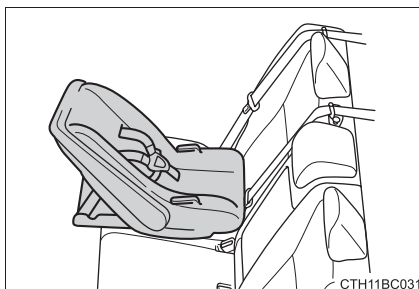

- 2 Run the seat belt through the child restraint system and insert the plate into the buckle. Make sure that the belt is not twisted.

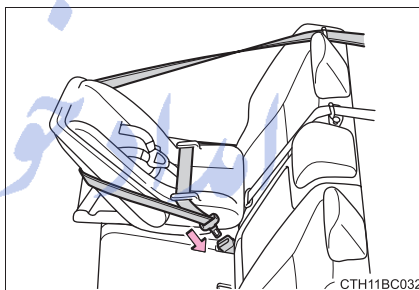

- 3 Install a locking clip near the tab of the lap and shoulder belt by inserting the lap and shoulder webbing through the recesses of the locking clip. Buckle the belt again. If the belt has any slack, release the buckle and reinstall the locking clip.

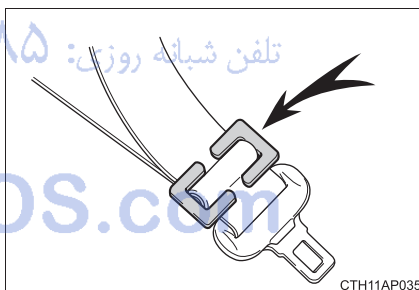



### ■ Forward-facing — Child seat

- 1 Place the child restraint system on the seat facing the front of the vehicle.

If your child restraint system interferes with a head restraint and cannot be installed properly, install the child restraint system after removing the head restraint. (→P. 159)

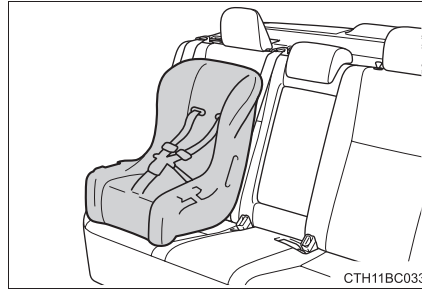

- 2 Run the seat belt through the child restraint system and insert the plate into the buckle. Make sure that the belt is not twisted.

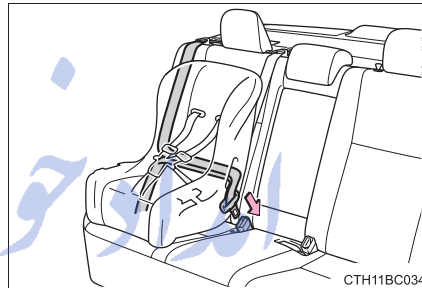

- 3 Install a locking clip near the tab of the lap and shoulder belt by inserting the lap and shoulder webbing through the recesses of the locking clip. Buckle the belt again. If the belt has any slack, release the buckle and reinstall the locking clip.

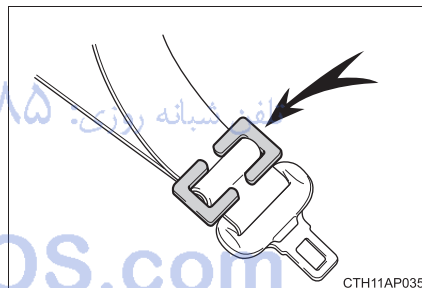

**■ Junior seat**

- 1 Place the child restraint system on the seat facing the front of the vehicle.

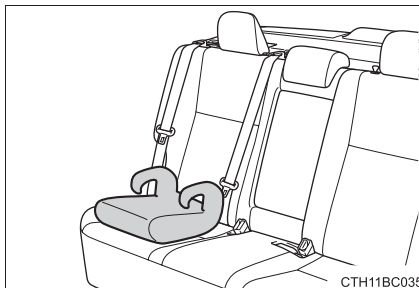

- 2 Sit the child in the child restraint system. Fit the seat belt to the child restraint system according to the manufacturer's instructions and insert the plate into the buckle. Make sure that the belt is not twisted.

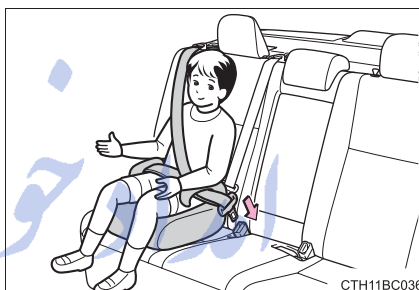

Check that the shoulder belt is correctly positioned over the child's shoulder and that the lap belt is as low as possible. (→P. 38)

**Removing a child restraint installed with a seat belt**

Push the buckle release button and fully retract the seat belt.

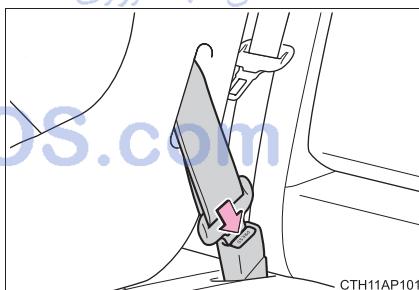

**Installation with ISOFIX rigid anchor**

- 1 Widen the gap between the seat cushion and seatback slightly.
- 2 Latch the buckles onto the exclusive fixing bars.

If the child restraint has a top strap, the top strap should be latched onto the anchor bracket.

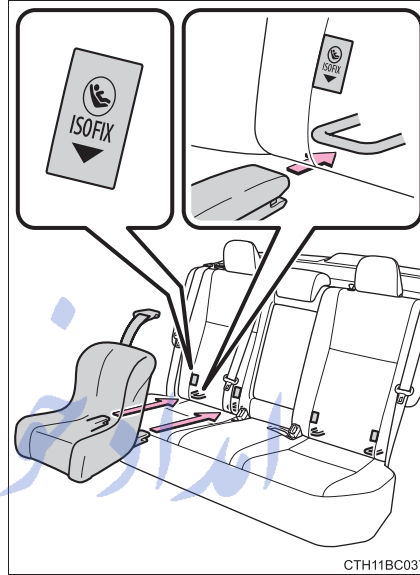

تلفن شبانه روزی: ۰۲۱-۸۸۸۶۲۰۸۵

FarmaSOS.com

**Child restraint systems with a top strap**

- 1 Adjust the head restraint to the downmost position. (→P. 159)
- 2 Secure the child restraint system using the seat belt or ISO-FIX rigid anchors.



- 3 Open the anchor bracket cover, latch the hook onto the anchor bracket and tighten the top strap.  
Make sure the top strap is securely latched.

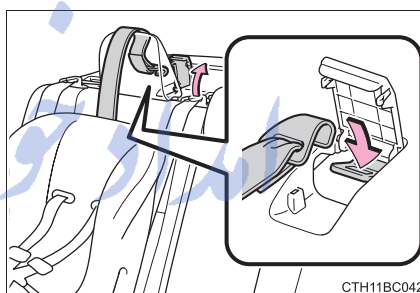

تلفن شبانه روزی: ۰۲۱-۸۸۸۶۲۰۸۵

FarmaSOS.com

### ■ When installing a child restraint system

You need a locking clip to install the child restraint system. Follow the instructions provided by the manufacturer of the system. If your child restraint system does not provide a locking clip, you can purchase the following item from any authorized Toyota dealer or repairer, or another duly qualified and equipped professional:

Locking clip for child restraint system  
(Part No. 73119-22010)

### ⚠ WARNING

#### ■ When installing a child restraint system

Follow the directions given in the child restraint system installation manual and fix the child restraint system securely in place.

If the child restraint system is not correctly fixed in place, the child or other passengers may be seriously injured or even killed in the event of a sudden braking or an accident.

- If the driver's seat interferes with the child restraint system and prevents it from being attached correctly, attach the child restraint system to the right-hand rear seat (left-hand drive vehicles) or the left-hand rear seat (right-hand drive vehicles).

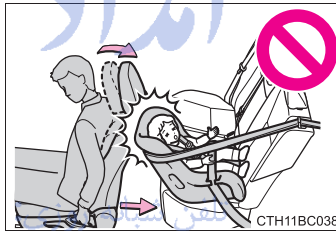

CTH11BC038

- Adjust the front passenger seat so that it does not interfere with the child restraint system.

- When installing a forward-facing child restraint system on the front passenger seat, move the seat as far back as possible and remove the head restraint. Failure to do so may result in death or serious injury if the airbags deploy (inflate).

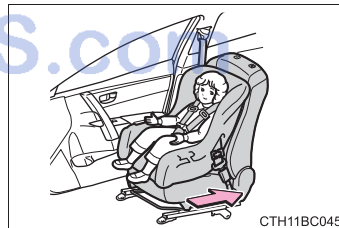

CTH11BC045

**⚠ WARNING**

■ **When installing a child restraint system**

- Never use a rear-facing child restraint system on the front passenger seat when the airbag manual on-off switch is on. (→P. 55)

The force of the rapid inflation of the front passenger airbag can cause death or serious injury to children in the event of an accident.

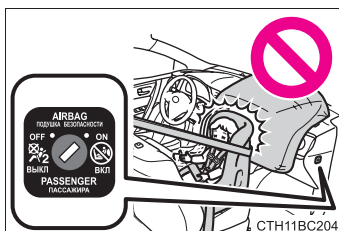

- There is a label(s) on the passenger side sun visor, indicating it is forbidden to attach a rear-facing child restraint system to the front passenger seat.

Details of the label(s) are shown in the illustration below.

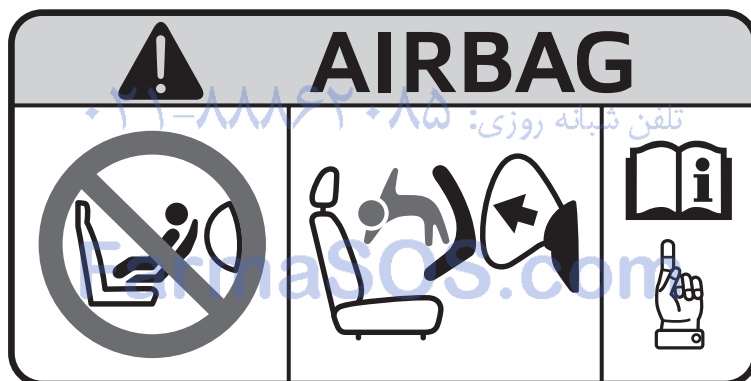
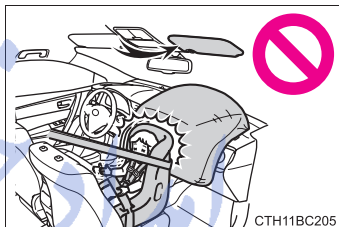

CTN17AG588

 WARNING**■ When installing a child restraint system**

- If child restraint system regulations exist in the country where you reside, please contact any authorized Toyota dealer or repairer, or another duly qualified and equipped professional for the child restraint system installation.
- When a junior seat is installed, always ensure that the shoulder belt is positioned across the center of the child's shoulder. The belt should be kept away from the child's neck, but not so that it could fall off the child's shoulder. Failing to do so may result in death or serious injury in the event of sudden braking, sudden swerving or an accident.
- Ensure that the belt and plate are securely locked and the seat belt is not twisted.
- Shake the child restraint system left and right, and forward and backward to ensure that it has been securely installed.
- After securing a child restraint system, never adjust the seat.
- Follow all installation instructions provided by the child restraint system manufacturer.

**■ To correctly attach a child restraint system to the anchors**

When using the lower anchors, be sure that there are no foreign objects around the anchors and that the seat belt is not caught behind the child restraint system. Make sure the child restraint system is securely attached, or it may cause death or serious injury to the child or other passengers in the event of a sudden braking or an accident.

1

For safety and security

FarmaSOS.com

## Exhaust gas precautions

**Harmful substance to the human body is included in exhaust gases if inhaled.**

### WARNING

Exhaust gases include harmful carbon monoxide (CO), which is colorless and odorless. Observe the following precautions.

Failure to do so may cause exhaust gases enter the vehicle and may lead to an accident caused by light-headedness, or may lead to death or a serious health hazard.

#### ■ Important points while driving

- Keep the trunk closed.
- If you smell exhaust gases in the vehicle even when the trunk is closed, open the windows and have the vehicle inspected at any authorized Toyota dealer or repairer, or another duly qualified and equipped professional as soon as possible.

#### ■ When parking

- If the vehicle is in a poorly ventilated area or a closed area, such as a garage, stop the engine.
- Do not leave the vehicle with the engine on for a long time.  
If such a situation cannot be avoided, park the vehicle in an open space and ensure that exhaust fumes do not enter the vehicle interior.
- Do not leave the engine running in an area with snow build-up, or where it is snowing. If snowbanks build up around the vehicle while the engine is running, exhaust gases may collect and enter the vehicle.

#### ■ Exhaust pipe

The exhaust system needs to be checked periodically. If there is a hole or crack caused by corrosion, damage to a joint or abnormal exhaust noise, be sure to have the vehicle inspected and repaired by any authorized Toyota dealer or repairer, or another duly qualified and equipped professional.



## Engine immobilizer system

The vehicle's keys have built-in transponder chips that prevent the engine from starting if a key has not been previously registered in the vehicle's on-board computer.

Never leave the keys inside the vehicle when you leave the vehicle.

This system is designed to help prevent vehicle theft but does not guarantee absolute security against all vehicle thefts.

Vehicles without a smart entry & start system:

The indicator light flashes after the key has been removed from the engine switch to indicate that the system is operating.

The indicator light stops flashing after the registered key has been inserted into the engine switch to indicate that the system has been canceled.

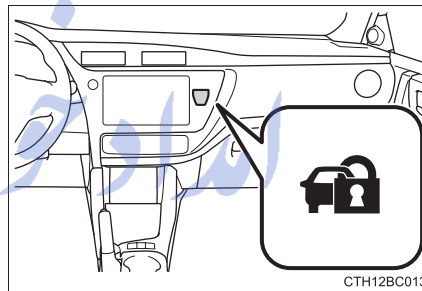

Vehicles with a smart entry & start system:

The indicator light flashes after the engine switch has been turned off to indicate that the system is operating.

The indicator light stops flashing after the engine switch has been turned to ACCESSORY or IGNITION ON mode to indicate that the system has been canceled.

**■ System maintenance**

The vehicle has a maintenance-free type engine immobilizer system.

**■ Conditions that may cause the system to malfunction**

- If the grip portion of the key is in contact with a metallic object
- If the key is in close proximity to or touching a key to the security system (key with a built-in transponder chip) of another vehicle

امداد خودرو فارما

تلفن شبانه روزی: ۰۲۱-۸۸۸۶۲۰۸۵

FarmaSOS.com

■ **Certification for the engine immobilizer system**

► Vehicles without a smart entry & start system

<p>Hereby, TRCZ s.r.o., declares that this RI-43BTY is in compliance with the essential requirements and other relevant provisions of Directives 1999/5/EC.</p>
<p>TRCZ s.r.o. vakuuttaa täten että RI-43BTY tyyppinen laite on direktiivin 1999/5/EY oleellisten vaatimusten ja sitä koskevien direktiivin muiden ehtojen mukainen.</p>
<p>Hierbij verklaart TRCZ s.r.o. dat het toestel RI-43BTY in overeenstemming is met de essentiële eisen en de andere relevante bepalingen van richtlijn 1999/5/EG.</p>
<p>Par la présente TRCZ s.r.o. déclare que l'appareil RI-43BTY est conforme aux exigences essentielles et aux autres dispositions pertinentes de la directive 1999/5/CE.</p>
<p>Härmed intygar TRCZ s.r.o. att denna RI-43BTY står i överensstämmelse med de väsentliga egenskapskrav och övriga relevanta bestämmelser som framgår av direktiv 1999/5/EG.</p>
<p>Undertegnede TRCZ s.r.o. erklærer herved, at følgende udstyr RI-43BTY overholder de væsentlige krav og øvrige relevante krav i direktiv 1999/5/EF.</p>
<p>Hiermit erklärt TRCZ s.r.o., dass sich das Gerät RI-43BTY in Übereinstimmung mit den grundlegenden Anforderungen und den übrigen einschlägigen Bestimmungen der Richtlinie 1999/5/EG befindet.</p>
<p>ΜΕ ΤΗΝ ΠΑΡΟΥΣΑ TRCZ s.r.o. ΔΗΛΩΝΕΙ ΟΤΙ RI-43BTY ΣΥΜΜΟΡΦΩΝΕΤΑΙ ΠΡΟΣ ΤΙΣ ΟΥΣΙΩΔΕΙΣ ΑΠΑΙΤΗΣΕΙΣ ΚΑΙ ΤΙΣ ΛΟΙΠΕΣ ΣΧΕΤΙΚΕΣ ΔΙΑΤΑΞΕΙΣ ΤΗΣ ΟΔΗΓΙΑΣ 1999/5/ΕΚ.</p>
<p>Con la presente TRCZ s.r.o. dichiara che questo RI-43BTY è conforme ai requisiti essenziali ed alle altre disposizioni pertinenti stabilite dalla direttiva 1999/5/CE.</p>
<p>Por medio de la presente TRCZ s.r.o. declara que el RI-43BTY cumple con los requisitos esenciales y cualesquiera otras disposiciones aplicables o exigibles de la Directiva 1999/5/CE.</p>
<p>TRCZ s.r.o. declara que este RI-43BTY está conforme com os requisitos essenciais e outras disposições da Directiva 1999/5/CE.</p>
<p>Hawnhekk, TRCZ s.r.o., jiddikjara li dan RI-43BTY jikkonforma mal-ħtiġijiet essenzjali u ma provvedimenti oħrajn relevanti li hemm fid-Dirrettiva 1999/5/EC.</p>
<p>Käesolevaga kinnitab TRCZ s.r.o. seadme RI-43BTY vastavust direktiivi 1999/5/EÜ põhinõuetele ja nimetatud direktiivist tulenevatele teistele asjakohastele sätetele.</p>
<p>Alulírott, TRCZ s.r.o. nyilatkozom, hogy a RI-43BTY megfelel a vonatkozó alapvető követelményeknek és az 1999/5/EC irányelv egyéb előírásainak.</p>

TRCZ s.r.o. týmto vyhlasuje, že RI-43BTY spĺňa základné požiadavky a všetky príslušné ustanovenia Smernice 1999/5/ES.
TRCZ s.r.o. tímto prohlašuje, že tento RI-43BTY je ve shodě se základními požadavky a dalšími příslušnými ustanoveními směrnice 1999/5/ES.
TRCZ s.r.o. izjavlja, da je ta RI-43BTY v skladu z bistvenimi zahtevami in ostalimi relevantnimi določili direktive 1999/5/ES.
Šiuo TRCZ s.r.o. deklaruoja, kad šis RI-43BTY atitinka esminius reikalavimus ir kitas 1999/5/EB Direktyvos nuostatas.
Ar šo TRCZ s.r.o. deklarē, ka RI-43BTY atbilst Direktīvas 1999/5/EK būtiskajām prasībām un citiem ar to saistītajiem noteikumiem.
Niniejszym TRCZ s.r.o. oświadcza, że RI-43BTY jest zgodny z zasadniczymi wymogami oraz pozostałymi stosownymi postanowieniami Dyrektywy 1999/5/EC.
Hér með lýsir TRCZ s.r.o. yfir því að RI-43BTY er í samræmi við grunnkröfur og aðrar kröfur, sem gerðar eru í tilskipun 1999/5/EC.
TRCZ s.r.o. erklærer herved at utstyret RI-43BTY er i samsvar med de grunnleggende krav og øvrige relevante krav i direktiv 1999/5/EF.
С настоящето, TRCZ s.r.o., декларира, че RI-43BTY е в съответствие със съществените изисквания и другите приложими разпоредби на Директива 1999/5/EC.
Prin prezenta, TRCZ s.r.o., declară că aparatul RI-43BTY este în conformitate cu cerințele esențiale și cu alte prevederi pertinente ale Directivei 1999/5/CE.
Ovim, TRCZ s.r.o., izjavljuje da ovaj RI-43BTY je usklađen sa bitnim zahtjevima i drugim relevantnim odredbama Direktive 1999/5/EC.
Nepermjet kesaj, TRCZ s.r.o., deklaruj qe ky RI-43BTY eshte ne pajtim me kerkesat thelbesore dhe dispozitat e tjera perkatese te Direktives 1999/5/EC.
Ovim TRCZ s.r.o., izjavljuje da je RI-43BTY u skladu s bitnim zahtjevima i drugim relevantnim odredbama Direktive 1999/5/EC i Pravilnika o RiTT opremi (NN 25/2012).
Ovim, TRCZ s.r.o., deklarirše da je RI-43BTY u skladu sa osnovnim zahtevima i ostalim relevantnim odredbama Direktive 1999/5/EC.
İşbu belge ile TRCZ s.r.o., bu RI-43BTY ürününün 1999/5/EC Yönetmeliği'nin temel gerekliliklerine ve diğer ilgili hükümlerine uygun olduğunu beyan eder.
The DECLARATION of CONFORMITY (DoC) is available at the following address: <a href="http://www.tokai-rika.co.jp/pc">http://www.tokai-rika.co.jp/pc</a>

## ► Vehicles with a smart entry &amp; start system

Hereby, TOYOTA MOTOR CORPORATION, declares that this TMIMB-3 is in compliance with the essential requirements and other relevant provisions of Directive 1999/5/EC.
TOYOTA MOTOR CORPORATION vakuuttaa täten että TMIMB-3 tyyppinen laite on direktiivin 1999/5/EY oleellisten vaatimusten ja sitä koskevien direktiivin muiden ehtojen mukainen.
Hierbij verklaart TOYOTA MOTOR CORPORATION dat het toestel TMIMB-3 in overeenstemming is met de essentiële eisen en de andere relevante bepalingen van richtlijn 1999/5/EG.
Par la présente TOYOTA MOTOR CORPORATION déclare que l'appareil TMIMB-3 est conforme aux exigences essentielles et aux autres dispositions pertinentes de la directive 1999/5/CE.
Härmed intygar TOYOTA MOTOR CORPORATION att denna TMIMB-3 står i överensstämmelse med de väsentliga egenskapskrav och övriga relevanta bestämmelser som framgår av direktiv 1999/5/EG.
Undertegnede TOYOTA MOTOR CORPORATION erklærer herved, at følgende udstyr TMIMB-3 overholder de væsentlige krav og øvrige relevante krav i direktiv 1999/5/EF.
Hiermit erklart TOYOTA MOTOR CORPORATION, dass sich das Gerät TMIMB-3 in Übereinstimmung mit den grundlegenden Anforderungen und den übrigen einschlägigen Bestimmungen der Richtlinie 1999/5/EG befindet.
ΜΕ ΤΗΝ ΠΑΡΟΥΣΑ ΤΟΥΤΑ ΜΟΤΟΡ ΚΟΡΠΟΡΑΤΙΟΝ ΔΗΛΩΝΕΙ ΟΤΙ ΤΜΙΜΒ-3 ΣΥΜΜΟΡΦΩΝΕΤΑΙ ΠΡΟΣ ΤΙΣ ΟΥΣΙΩΔΕΙΣ ΑΠΑΙΤΗΣΕΙΣ ΚΑΙ ΤΙΣ ΛΟΙΠΕΣ ΣΧΕΤΙΚΕΣ ΔΙΑΤΑΞΕΙΣ ΤΗΣ ΟΔΗΓΙΑΣ 1999/5/ΕΚ.
Con la presente TOYOTA MOTOR CORPORATION dichiara che questo TMIMB-3 è conforme ai requisiti essenziali ed alle altre disposizioni pertinenti stabilite dalla direttiva 1999/5/CE.
Por medio de la presente TOYOTA MOTOR CORPORATION declara que el TMIMB-3 cumple con los requisitos esenciales y cualesquiera otras disposiciones aplicables o exigibles de la Directiva 1999/5/CE.
TOYOTA MOTOR CORPORATION declara que este TMIMB-3 está conforme com os requisitos essenciais e outras disposições da Directiva 1999/5/CE.

1

For safety and security

Hawnhekk, TOYOTA MOTOR CORPORATION, jiddikjara li dan TMIMB-3 jikkonforma mal-ħtigijiet essenzjali u ma provvedimenti oħrajn relevanti li hemm fid-Dirrettiva 1999/5/EC.
Käesolevaga kinnitab TOYOTA MOTOR CORPORATION seadme TMIMB-3 vastavust direktiivi 1999/5/EÜ pöhinöuetele ja nimetatud direktiivist tulenevatele teistele asjakohastele sätetele.
Alulirott, TOYOTA MOTOR CORPORATION nyilatkozom, hogy a TMIMB-3 megfelel a vonatkozó alapvető követelményeknek és az 1999/5/EC irányelv egyéb előírásainak.
TOYOTA MOTOR CORPORATION týmto vyhlasuje, že TMIMB-3 spĺňa základné požiadavky a všetky príslušné ustanovenia Smernice 1999/5/ES.
TOYOTA MOTOR CORPORATION tímto prohlašuje, že tento TMIMB-3 je ve shodě se základními požadavky a dalšími příslušnými ustanoveními směrnice 1999/5/ES.
TOYOTA MOTOR CORPORATION izjavlja, da je ta TMIMB-3 v skladu z bistvenimi zahtevami in ostalimi relevantnimi določili direktive 1999/5/ES.
Šiuo TOYOTA MOTOR CORPORATION deklaruoja, kad šis TMIMB-3 atitinka esminius reikalavimus ir kitas 1999/5/EB Direktyvos nuostatas.
Ar šo TOYOTA MOTOR CORPORATION deklarē, ka TMIMB-3 atbilst Direktīvas 1999/5/EK būtiskajām prasībām un citiem ar to saistītajiem noteikumiem.
Niniejszym TOYOTA MOTOR CORPORATION oświadcza, że TMIMB-3 jest zgodny z zasadniczymi wymogami oraz pozostałymi stosownymi postanowieniami Dyrektywy 1999/5/EC.
Hér með lýsir TOYOTA MOTOR CORPORATION yfir því að TMIMB-3 er í samræmi við grunnkröfur og aðrar kröfur, sem gerðar eru í tilskipun 1999/5/EC.
TOYOTA MOTOR CORPORATION erklærer herved at utstyret TMIMB-3 er i samsvar med de grunnleggende krav og øvrige relevante krav i direktiv 1999/5/EF.

С настоящето, TOYOTA MOTOR CORPORATION, декларира, че TMIMB-3 е в съответствие със съществените изисквания и другите приложими разпоредби на Директива 1999/5/EC.
Prin prezenta, TOYOTA MOTOR CORPORATION, declară că aparatul TMIMB-3 este în conformitate cu cerințele esențiale și cu alte prevederi pertinente ale Directivei 1999/5/CE.
Ovim, TOYOTA MOTOR CORPORATION, izjavljuje da ovaj TMIMB-3 je usklađen sa bitnim zahtjevima i drugim relevantnim odredbama Direktive 1999/5/EC.
Nepermjet kesaj, TOYOTA MOTOR CORPORATION, deklaroi qe ky TMIMB-3 eshte ne pajtim me kerkesat thelbesore dhe dispozitat e tjera perkatese te Direktives 1999/5/EC.
Ovim TOYOTA MOTOR CORPORATION, izjavljuje da je TMIMB-3 u skladu s bitnim zahtjevima i drugim relevantnim odredbama Direktive 1999/5/EC i Pravilnika o RITT opremi (NN 25/2012).
Ovim, TOYOTA MOTOR CORPORATION, deklarirše da je TMIMB-3 u skladu sa osnovnim zahtevima i ostalim relevantnim odredbama Direktive 1999/5/EC.
İşbu belge ile TOYOTA MOTOR CORPORATION, bu TMIMB-3 ürününün 1999/5/EC Yönetmeliği'nin temel gerekliliklerine ve diğer ilgili hükümlerine uygun olduğunu beyan eder.

 NOTICE

- **To ensure the system operates correctly**  
Do not modify or remove the system. If modified or removed, the proper operation of the system cannot be guaranteed.

**TOYOTA****TOYOTA MOTOR CORPORATION**

1, TOYOTA-CHO, TOYOTA, AICHI, 471-8571, JAPAN TEL: +81-565-28-2121

## R&amp;TTE Declaration of Conformity

We,

Manufacturer's Name: TOYOTA MOTOR CORPORATION  
Manufacturer's Address: 1, Toyota -cho, Toyota, Aichi, 471-8572, Japan

hereby declare under our sole responsibility that the product:

Product Name: Immobilizer  
Product Model: TMIMB-3

to which this declaration relates is in conformity with the essential requirements and other relevant requirements of the R&TTE Directive (1999/5/EC). The product is compliant with the following standards and/or other normative documents:

-Health & safety requirements: EN 60950-1  
-EMC requirements: EN 301 489-01 & EN 301 489-03  
-Effective uses of radio spectrum: EN 300 330-2

Supplementary information:

* CE mark	
* Member states intended for use	EU and EFTA

Date: February 25, 2013

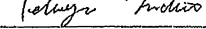
Signature:   
Tetsuya Matsuo



**2. Instrument cluster**

Warning lights and indicators .....	86
Gauges and meters .....	92
Drive monitor display .....	95
Multi-information display ....	101
Fuel consumption ◆ information.....	112

امداد خودرو فارما





















تلفن شبانه روزی: ۰۲۱-۸۸۸۶۲۰۸۵









FarmaSOS.com



## Warning lights

Warning lights inform the driver of malfunctions in the indicated vehicle's systems.

*1 	*1 Brake system warning light (→P. 513)	*1, 3 	*1, 3 Automatic headlight leveling system warning light (→P. 515)
*1, 3 	*1, 3 Charging system warning light (→P. 513)	*1, 3 	*1, 3 LED headlight warning light (→P. 515)
*1, 3 	*1, 3 Low engine oil pressure warning light (→P. 513)	*3, 5  (Yellow)	*3, 5 Cruise control indicator light (→P. 516)
*1, 3 	*1, 3 High engine temperature warning light (→P. 513)	*1, 3, 7 	*1, 3, 7 PCS warning light (→P. 516)
*1, 3 	*1, 3 Multi-mode manual transmission warning light (→P. 514)	*1, 2, 3, 7 	*1, 2, 3, 7 Stop & Start cancel indicator (→P. 516)
*1 	*1 Malfunction indicator lamp (→P. 514)	*3, 4  (Yellow)	*3, 4 Smart entry & start system indicator light (→P. 517)
*1 	*1 SRS warning light (→P. 514)	*1, 3 	*1, 3 Fuel filter warning light (→P. 516)
*1 	*1 ABS warning light (→P. 515)	*3 	*3 Open door warning light (→P. 517)
*1 	*1 Electric power steering system warning light (→P. 515)		Low fuel level warning light (→P. 517)
*1 	*1 Slip indicator (→P. 515)		Driver's and front passenger's seat belt reminder light (→P. 517)

<p><sup>*6</sup></p> 	<p>Rear passengers' seat belt reminder lights (→P. 517)</p>	<p><sup>*3</sup></p> 	<p>Low windshield washer fluid warning light (→P. 517)</p>
<p><sup>*1, 3</sup></p> 	<p>Low engine oil level warning light (→P. 517)</p>	<p><sup>*1</sup></p> 	<p>Tire pressure warning light (→P. 519)</p>
<p><sup>*1, 3</sup></p> 	<p>Engine oil change reminder light (→P. 518)</p>	<p><sup>*1, 3</sup></p> 	<p>DPF system warning light (→P. 518)</p>
<p><sup>*1, 3</sup></p> 	<p>Master warning light (→P. 518)</p>	<p><sup>*3, 5</sup></p>  <p>(Yellow)</p>	<p>Speed limiter indicator (→P. 517)</p>

<sup>\*1</sup>: These lights turn on when the engine switch is turned to the "ON" position (vehicles without a smart entry & start system) or IGNITION ON mode (vehicles with a smart entry & start system) to indicate that a system check is being performed. They will turn off after the engine is started, or after a few seconds. There may be a malfunction in a system if a light does not come on, or turn off. Have the vehicle inspected by any authorized Toyota dealer or repairer, or another duly qualified and equipped professional.

<sup>\*2</sup>: Vehicles with a multi-information display: As these lights are displayed on the multi-information display, they will not turn on when a system check, as described in <sup>\*1</sup> above, is being performed.

<sup>\*3</sup>: If equipped

<sup>\*4</sup>: The light flashes in yellow to indicate a malfunction. The light flashes quickly in green to indicate that the steering lock has not been released.

<sup>\*5</sup>: Vehicles with a drive monitor display: The light comes on in yellow to indicate a malfunction.





















Vehicles with a multi-information display: →P. 288, 292







<sup>\*6</sup>: This light illuminates on the center panel.

<sup>\*7</sup>: The light flashes to indicate a malfunction.

## Indicators

The indicators inform the driver of the operating state of the vehicle's various systems.

	Turn signal indicator (→P. 222)	<sup>*1, 4</sup> 	Slip indicator (→P. 315, 321)
	Headlight high beam indicator (→P. 224)	<sup>*3</sup> 	Tail light indicator (→P. 224)
<sup>*1, 3</sup> 	Automatic High Beam indicator (→P. 264)	<sup>*3</sup> 	Smart entry & start system indicator (→P. 199)
<sup>*3</sup> 	Front fog light indicator (→P. 230)	<sup>*3</sup> 	Speed limiter indicator (→P. 290)
	Rear fog light indicator (→P. 230)	<sup>*3</sup> 	"SPORT" indicator (→P. 210)
<sup>*1, 3</sup> 	Gear Shift Indicator (Drive monitor display) (→P. 215, 219)	<sup>*1, 2, 3</sup> 	Stop & Start indicator (→P. 274)
<sup>*3</sup> 	Gear Shift Indicator (Multi-information display) (→P. 215, 219)	<sup>*1, 2, 3, 8</sup> 	Stop & Start cancel indicator (→P. 274)
<sup>*3</sup> 	Cruise control indicator (→P. 286)	<sup>*3</sup> 	Cruise control "SET" indicator (→P. 286)
<sup>*3</sup> 	Engine preheating indicator (→P. 196, 199)	<sup>*3</sup> 	LDA (Lane Departure Alert) indicator (→P. 259)
<sup>*1, 8</sup> 	VSC OFF indicator (→P. 315)	<sup>*3</sup> 	Toyota parking assist-sensor indicator (→P. 293)

<p><sup>*3</sup></p>  <p>Simple-IPA indicator (→P. 299)</p>	<p><sup>*6</sup></p>  <p>Security indicator (→P. 77)</p>
<p><sup>*1, 3, 8</sup></p>  <p>PCS warning light (→P. 246)</p>	<p><sup>*1, 2, 3, 5</sup></p>  <p>Eco Driving Indicator Light (→P. 99, 109)</p>
<p><sup>*1, 8</sup></p>  <p>“TRC OFF” indicator (→P. 315)</p>	<p><sup>*3, 7</sup></p>  <p>Low outside tempera- ture indicator (→P. 92)</p>
<p><sup>*1, 6</sup></p>  <p>“PASSENGER AIR BAG” indicator (→P. 55)</p>	

- <sup>\*1</sup>: These lights turn on when the engine switch is turned to the “ON” position (vehicles without a smart entry & start system) or IGNITION ON mode (vehicles with a smart entry & start system) to indicate that a system check is being performed. They will turn off after the engine is started, or after a few seconds. There may be a malfunction in a system if a light does not come on, or turn off. Have the vehicle inspected by any authorized Toyota dealer or repairer, or another duly qualified and equipped professional.
- <sup>\*2</sup>: Vehicles with a multi-information display: As these lights are displayed on the multi-information display, they will not turn on when a system check, as described in <sup>\*1</sup> above, is being performed.
- <sup>\*3</sup>: If equipped
- <sup>\*4</sup>: The light flashes to indicate that the system is operating.
- <sup>\*5</sup>: The light does not turn on when the system is disabled.
- <sup>\*6</sup>: This light illuminates on the center panel.
- <sup>\*7</sup>: When the outside temperature is approximately 3°C (37°F) or lower, the indicator will flash for approximately 10 seconds, then stay on.
- <sup>\*8</sup>: The light turns on when the system is turned off.

 **WARNING****■ If a safety system warning light does not come on**

Should a safety system light such as the ABS and SRS warning lights not come on when you start the engine, this could mean that these systems are not available to help protect you in an accident, which could result in death or serious injury. Have the vehicle inspected by any authorized Toyota dealer or repairer, or another duly qualified and equipped professional immediately if this occurs.

امداد خودرو فارما

تلفن شبانه روزی: ۰۲۱-۸۸۸۶۲۰۸۵

FarmaSOS.com

## Gauges and meters

### ► Drive monitor display

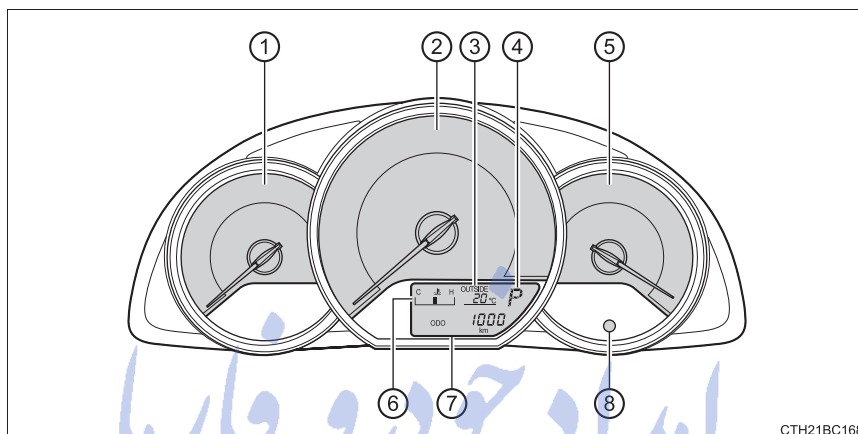

### ► Multi-information display

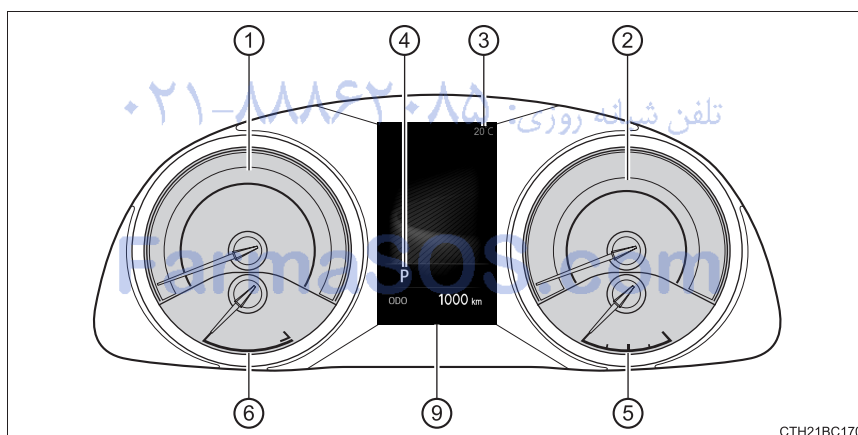



- ① Tachometer  
Displays the engine speed in revolutions per minute.
- ② Speedometer  
Displays the vehicle speed.
- ③ Outside temperature  
Displays the outside temperature within the range of -40°C (-40°F) to 50°C (122°F).  
Drive monitor display: If the outside temperature is 3°C (37°F) or lower, the temperature display flashes 10 times, and then illuminates.  
Multi-information display: Low outside temperature indicator comes on when the ambient temperature is 3°C (37°F) or lower.
- ④ Shift position and gear position indicator (if equipped)  
→P. 209, 213
- ⑤ Fuel gauge  
Displays the quantity of fuel remaining in the tank.
- ⑥ Engine coolant temperature gauge  
Displays the engine coolant temperature.  
Drive monitor display (vehicles with a Multidrive): When the average fuel economy is displayed, the Eco Driving Indicator zone display (→P. 99) will be displayed instead of the engine coolant temperature gauge.
- ⑦ Drive monitor display (if equipped)  
→P. 95
- ⑧ Display change switch  
Changes the item displayed on the drive monitor display.  
The "DISP" switch on the steering wheel can also be used to change the item displayed on the multi-information display.
- ⑨ Multi-information display (if equipped)  
→P. 101

**■ The meters and display illuminate when**

- ▶ Vehicles without a smart entry & start system

The engine switch is in the "ON" position.

- ▶ Vehicles with a smart entry & start system

The engine switch is in IGNITION ON mode.

**■ Outside temperature display**

- In the following situations, the correct outside temperature may not be displayed, or the display may take longer than normal to change.
  - When stopped, or driving at low speeds (less than 15 km/h [9 mph])
  - When the outside temperature has changed suddenly (at the entrance/exit of a garage, tunnel, etc.)
- If "– °C" is displayed continuously, the system may be malfunctioning. Take your vehicle to any authorized Toyota dealer or repairer, or another duly qualified and equipped professional.

**NOTICE****■ To prevent damage to the engine and its components**

- Do not let the indicator needle of the tachometer enter the red zone, which indicates the maximum engine speed.
- In the following situations, the engine may be overheating. In this case, immediately stop the vehicle in a safe place, and check the engine after it has cooled completely. (→P. 584)
  - Drive monitor display: The high engine coolant temperature warning light comes on
  - Multi-information display: The engine coolant temperature gauge enters the red zone

## Drive monitor display\*

### Display content

The drive monitor display presents the driver with a variety of driving-related data, such as the current outside temperature.

- Engine coolant temperature gauge (→P. 92)
- Outside temperature (→P. 92)
- Shift position and gear position indicator (if equipped) (→P. 209, 213)
- Trip information/Drive information/Meter light control (→P. 96)

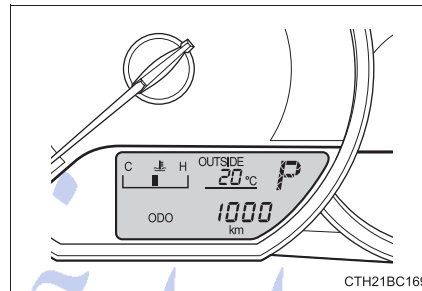

Displays the following items:

- Odometer
- Trip meter
- Stop & Start system operation time (if equipped)
- Stop & Start system total operation time (if equipped)
- Average fuel consumption
- Driving range
- Meter light control
- Display customization (→P. 98)
  - Eco Driving Indicator Light (if equipped)
  - Stop & Start system operation time (if equipped)

2

Instrument cluster

\*: If equipped

### Trip information/Drive information/Meter light control

#### ◆ Changing the display

To change the displayed item, press the display change switch or the “DISP” switch.

Each time the switch is pressed, the displayed item will be changed.

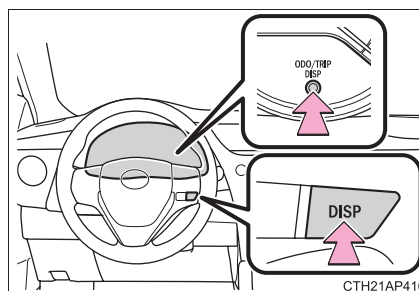

#### ◆ Display items

##### ■ Odometer

“ ODO ” will be displayed.

Displays the total distance the vehicle has been driven.

##### ■ Trip meter A/trip meter B

“ TRIP **A** ”/“ TRIP **B** ” will be displayed.

Displays the distance the vehicle has been driven since the meter was last reset. Trip meters A and B can be used to record and display different distances independently.

To reset, display the desired trip meter and press and hold the display change switch or the “DISP” switch.

##### ■ Stop & Start system operation time (if equipped)

“ ECO ” will be displayed.

Displays the amount of time the engine was stopped due to the operation of the Stop & Start system during the current trip (from when the engine was started until it is turned off).

##### ■ Stop & Start system total operation time (if equipped)

“ ECO ODO ” will be displayed.

Displays the total amount of time that the engine has been stopped due to the operation of the Stop & Start system since the meter was last reset.

To reset, display the Stop & Start system total operation time and press and hold the display change switch or the “DISP” switch.

### ■ Average fuel consumption

“ AVG. ” will be displayed.

Displays the average fuel consumption since the function was reset.

- To reset, display the average fuel consumption and press and hold the display change switch or the “DISP” switch.
- Vehicles with a Multidrive: When the display is changed to the average fuel economy display, the Eco Driving Indicator zone display (→P. 99) will be displayed instead of the engine coolant temperature gauge.
- Use the displayed average fuel consumption as a reference.

### ■ Driving range

“RANGE” will be displayed.

Displays the estimated maximum distance that can be driven with the quantity of fuel remaining.

- This distance is computed based on your average fuel consumption. As a result, the actual distance that can be driven may differ from that displayed.
- When only a small amount of fuel is added to the tank, the display may not be updated.
- When refueling, turn the engine switch off. If the vehicle is refueled without turning the engine switch off, the display may not be updated.

### ■ Meter light control display

Displays the meter light control display: *تلفن شبانه روزی: ۰۲۱-۸۸۸۹۰۸۸۹*

- The meter light control display can only be displayed when the tail lights are on.
- The brightness of the meters can only be adjusted when the tail lights are on.
- To adjust the brightness, display the meter light control display and press and hold the display change switch or the “DISP” switch.

### Display customization

The following display items can be customized:

#### ◆ Customizable items

##### ■ Eco Driving Indicator Light (if equipped)

Can be enabled or disabled

##### ■ Stop & Start system operation time pop-up display (if equipped)

Current Stop & Start system operation time can be enabled or disabled.

#### ◆ Customizing the display

- 1 To change to the customizing mode screen, display the odometer and then press and hold the display change switch or the "DISP" switch for 5 seconds or more.
- 2 To change the setting, press the display change switch or the "DISP" switch.

Each time the switch is pressed, the setting will be changed.

After customization, press the display change switch or "DISP" switch for 2 seconds or more to return to the odometer.

FarmaSOS.com

### ■ Eco Driving Indicator (if equipped)

- ① Eco Driving Indicator Light  
During Eco-friendly acceleration (Eco driving), the Eco Driving Indicator Light will turn on. When the acceleration exceeds the Zone of Eco driving, or when the vehicle is stopped, the light turns off.

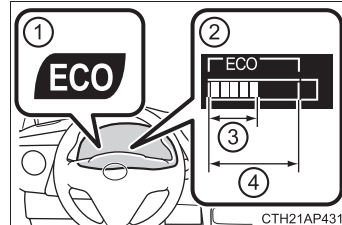

- ② Eco Driving Indicator Zone Display  
Suggests the Zone of Eco driving with current Eco driving ratio based on acceleration.
- ③ Eco driving ratio based on acceleration  
If the acceleration exceeds the Zone of Eco driving, the right side of the Eco Driving Indicator Zone Display blinks and the Eco Driving Indicator light will turn off.
- ④ Zone of Eco driving

Eco Driving Indicator will not operate under the following conditions:

- The shift lever is in any position other than D.
- Sport mode is selected.
- The vehicle speed is approximately 130 km/h (80 mph) or higher.

### ■ Stop & Start system operation time pop-up display (if equipped)

When enabled (→P. 98), the current Stop & Start system operation time will be displayed on the drive monitor display.

### ■ Brightness of the meters

When the tail lights are turned on, the brightness will be reduced slightly unless the meters are set to the maximum brightness level.

### ■ When disconnecting and reconnecting battery terminals

The following information data will be reset:

- Average fuel consumption
- Driving range

### ■ Liquid crystal display

Small spots or light spots may appear on the display. This phenomenon is characteristic of liquid crystal displays, and there is no problem continuing to use the display.

 WARNING

■ **Caution for use while driving**

- When operating the drive monitor display while driving, pay extra attention to the safety of the area around the vehicle.
- Do not look continuously at the drive monitor display while driving as you may fail to see pedestrians, objects on the road, etc. ahead of the vehicle.

■ **The display at low temperatures**

Allow the interior of the vehicle to warm up before using the display. At extremely low temperatures, the display monitor may respond slowly, and display changes may be delayed.

For example, there is a lag between the driver's shifting and the new gear number appearing on the display. This lag could cause the driver to down-shift again, causing rapid and excessive engine braking and possibly an accident resulting in death or injury.

■ **Cautions during setting up the display**

As the engine needs to be running during setting up the display, ensure that the vehicle is parked in a place with adequate ventilation. In a closed area such as a garage, exhaust gases including harmful carbon monoxide (CO) may collect and enter the vehicle. This may lead to death or a serious health hazard.

تلفن شبانه روزی: ۰۲۱-۸۸۶۲۰۸۵

FarmaSOS.com



## Multi-information display\*

### Display content

The multi-information display presents the driver with a variety of driving-related data, such as the current outside temperature. The multi-information display can also be used to change the display settings and other settings.

- Outside temperature (→P. 92)
- Shift position and gear position indicator (if equipped) (→P. 209, 213)
- Pop-up display

In some situations a warning message or the operation status of a system will be temporarily displayed on the multi-information display.

On some models: Some pop-up displays can be set on/off. (→P. 107)

- Trip information (→P. 103)

Displays the following items:

- Odometer
- Trip meter

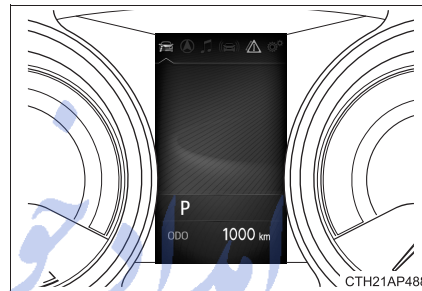

2

Instrument cluster

FarmaSOS.com

\*: If equipped

● Menu icons (→P. 104)

Select a menu icon to display its content.

To display the menu icons, press the < or > switch on the steering wheel.



Drive information (→P. 105)

Select to display various drive data.



Navigation system-linked display (if equipped)

Select to display the following navigation system-linked information.

- Route guidance
- Compass display (north-up display/heading-up display)



Audio system-linked display (if equipped)

Select to enable selection of an audio source or track on the meter using the meter control switches.



Driving assist system information (if equipped)

Select to display the operational status of the following systems:

- LDA (Lane Departure Alert) (→P. 259)
- RSA (Road Sign Assist) (→P. 268)



Warning message display (→P. 526)

Select to display warning messages and measures to be taken if a malfunction is detected.



Settings display (→P. 107)

Select to change the meter display settings and other settings.

### Trip information

#### ◆ Changing the display

To change the displayed item, press the “TRIP” switch.

Each time the switch is pressed, the displayed item will be changed.

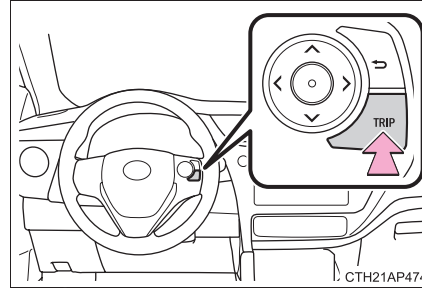

#### ◆ Display items

##### ■ Odometer

Displays the total distance the vehicle has been driven.

##### ■ Trip meter A/trip meter B

Displays the distance the vehicle has been driven since the meter was last reset. Trip meters A and B can be used to record and display different distances independently.

To reset, display the desired trip meter and press and hold the “TRIP” switch.

FarmaSOS.com

### Menu icons

#### ◆ Operating the meter control switches

The multi-information display is operated using the meter control switches.

- ① < > : Display the menu icons/select menu icons
- ^ v : Change displayed item, scroll up/down the screen and move the cursor up/down
- ② Press: Enter/Set  
Press and hold: Reset
- ③ Return to the previous screen

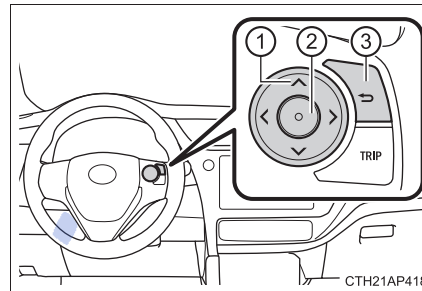

تلفن شبانه روزی: ۰۲۱-۸۸۶۲۰۸۵

FarmaSOS.com







### ◆ Drive information







#### ■ Drive information 1/Drive information 2/Drive information 3

Displays drive information such as the following:

- Drive information 1
  - Current fuel consumption (gauge display)
  - Average fuel economy (after reset)
- Drive information 2
  - Distance (driving range)
  - Average vehicle speed (after reset)
- Drive information 3 (if equipped)
  - Stop & Start system operation time (after start)
  - Stop & Start system operation time (after reset)

Displayed items (listed below) can be changed on the settings display. (→P. 107)

Item	Content
 Current fuel consumption (gauge display)	Displays the current rate of fuel consumption on a gauge display
 Current fuel consumption (numeric display)	Displays the current rate of fuel consumption as a number <i>نظن شبانه روز</i>
 Average fuel economy (after reset)	Displays average fuel consumption since display reset <sup>*2, 3</sup>
 Average fuel economy (after start)	Displays average fuel consumption since engine start <sup>*3</sup>
 Average fuel economy (after refuel)	Displays average fuel consumption since refuel <sup>*3, 4</sup>
 Stop & Start system operation time (after reset) <sup>*1</sup>	Displays the total amount of time the engine has been stopped due to the operation of the Stop & Start system since the system was last reset <sup>*2</sup>
 Stop & Start system operation time (after start) <sup>*1</sup>	Displays the amount of time the engine has been stopped due to the operation of the Stop & Start system since the engine was started

Item		Content
	Average vehicle speed (after reset)	Displays average vehicle speed since display reset*2
	Average vehicle speed (after start)	Displays average vehicle speed since engine start
	Elapsed time (after reset)	Displays elapsed time since display reset*2
	Elapsed time (after start)	Displays elapsed time since engine start
	Distance (driving range)	Displays driving range with remaining fuel*4, 5
	Distance (after start)	Displays drive distance since vehicle start
	Blank	No item

\*1: If equipped

\*2: Values that can be reset will be displayed with a circle (●) in the upper right corner.

To reset, display the desired item and press and hold  switch. If both displayed items are resettable, a reset selection screen will appear.

\*3: Use the displayed fuel consumption as a reference.

\*4: When only a small amount of fuel is added to the tank, the display may not be updated.

When refueling, turn the engine switch off. If the vehicle is refueled without turning the engine switch off, the display may not be updated.

\*5: This distance is computed based on your average fuel consumption. As a result, the actual distance that can be driven may differ from that displayed.

#### ■ Eco Driving Indicator (if equipped)

→P. 109

#### ■ Digital speedometer

Displays vehicle speed as a number.

### ◆ Settings display

#### ■ LDA (Lane Departure Alert) warning sensitivity (if equipped)

LDA warning sensitivity can be set to 2 different levels.

#### ■ Toyota parking assist-sensor (if equipped)

Select to activate/deactivate the Toyota parking assist-sensor system.

#### ■ RSA (Road Sign Assist) (if equipped)

Select to activate/deactivate the RSA system.

#### ■ Meter light control

Select to adjust the brightness of the meters when in night mode\*.

\*: Night mode: →P. 110

#### ■ Other settings

Select to change the following settings:

##### ● RSA (Road Sign Assist) setting (if equipped)

###### • Notification method (excess speed/other warnings)

Select to change the notification method of the following warnings to no notification/display only/display and buzzer.

Excess speed warning:

Warns the driver if the vehicle exceeds the speed displayed on the speed limit sign on the multi-information display.

Other warnings:

Warns the driver if the system determines that the vehicle is overtaking when a no overtaking sign is displayed on the multi-information display.

###### • Excess speed notification level

Select to set the speed threshold over which the excess speed warning starts to operate when a speed limit sign is displayed on the multi-information display.

##### ● Stop & Start system setting (if equipped)

The length of time the Stop & Start system will operate when the "A/C" switch of the air conditioning system is on can be set to 2 different levels.

● Units

Select to change the units of measure displayed on the multi-information display.

●  Eco Driving Indicator Light (if equipped)

Select to activate/deactivate the Eco Driving Indicator Light.

● Drive information 1/Drive information 2/Drive information 3

Select to select up to 2 items that will be displayed on the Drive information 1 screen, Drive information 2 screen and Drive information 3 screen (if equipped) respectively. (→P. 105)

● Pop-up display

Select to set the following pop-up displays on/off.

- Incoming call display of the hands-free phone system (if equipped)
- Route guidance display of the navigation system-linked system (if equipped)
- Stop & Start system (if equipped)

● Initialization

Select to reset the meter display settings. (→P. 612)

■  Language

Select to change the language on the display. تلفن شبانه ۰۲۱-۸۸۴۲۰۸۸

FarmaSOS.com



### ■ Eco Driving Indicator (if equipped)

#### ① Eco Driving Indicator Light

During Eco-friendly acceleration (Eco driving), the Eco Driving Indicator Light will turn on. When the acceleration exceeds the Zone of Eco driving, or when the vehicle is stopped, the light turns off.

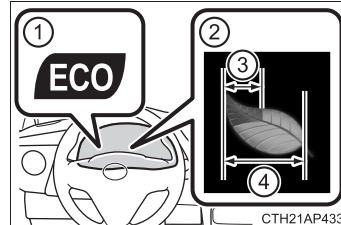

#### ② Eco Driving Indicator Zone Display

Suggests the Zone of Eco driving with current Eco driving ratio based on acceleration.

#### ③ Eco driving ratio based on acceleration

The number of green segments displayed on the Eco Driving Indicator Zone Display decreases/increases depending on the acceleration. If the acceleration exceeds the Zone of Eco driving, all of the green segments will disappear and the Eco Driving Indicator light will turn off.

#### ④ Zone of Eco driving

Eco Driving Indicator will not operate under the following conditions:

- The shift lever is in any position other than D.
- Sport mode is selected.
- The vehicle speed is approximately 130 km/h (80 mph) or higher.

### ■ Stop & Start system information pop-up display (if equipped)

In some situations the following Stop & Start system information will be temporarily displayed on the multi-information display:

- Current Stop & Start system operation time
- Stop & Start operational status messages (→P. 281)

**■ Brightness of the meters (day mode and night mode)**

- The brightness of the meters is changed between day mode and night mode.
  - ▶ Vehicles without automatic light control system
    - Day mode: When the tail lights are off
    - Night mode: When the tail lights are on
  - ▶ Vehicles with automatic light control system
    - Day mode: When the tail lights are off or when the tail lights are on but the surrounding area is bright
    - Night mode: When the tail lights are on and the surrounding area is dark
- When in night mode, the brightness will be reduced slightly unless the meters are set to the maximum brightness level.

**■ Suspension of the settings display**

- While driving, the multi-information display cannot be changed to some setting modes. Before changing the settings, stop the vehicle in a safe place.
- In the following situations, operation of some of the settings display may be temporarily suspended.
  - When a warning message appears on the multi-information display
  - When the vehicle begins to move

**■ When disconnecting and reconnecting battery terminals**

The drive information data\* will be reset.

\*: Except Stop & Start system operation time

**■ Liquid crystal display**

Small spots or light spots may appear on the display. This phenomenon is characteristic of liquid crystal displays, and there is no problem continuing to use the display.

**■ Ending display**

When the engine switch is turned off, the following information about the current trip will be temporarily displayed on the multi-information display.

- Elapsed time (after start)
- Distance (after start)
- Average fuel economy (after start)

**⚠ WARNING****■ Caution for use while driving**

- When operating the multi-information display while driving, pay extra attention to the safety of the area around the vehicle.
- Do not look continuously at the multi-information display while driving as you may fail to see pedestrians, objects on the road, etc. ahead of the vehicle.

**■ The information display at low temperatures**

Allow the interior of the vehicle to warm up before using the liquid crystal information display. At extremely low temperatures, the information display monitor may respond slowly, and display changes may be delayed. For example, there is a lag between the driver's shifting and the new gear number appearing on the display. This lag could cause the driver to down-shift again, causing rapid and excessive engine braking and possibly an accident resulting in death or injury.

**■ Cautions during setting up the display**

As the engine needs to be running during setting up the display, ensure that the vehicle is parked in a place with adequate ventilation. In a closed area such as a garage, exhaust gases including harmful carbon monoxide (CO) may collect and enter the vehicle. This may lead to death or a serious health hazard.

**⚠ NOTICE****■ While setting up the display**

To prevent battery discharge, ensure that the engine is running while setting up the display features.

تلفن شبانه روزی: ۰۸۵-۸۸۶۲۰۸۱-۲۱

FarmaSOS.com

## Fuel consumption information\*

Fuel consumption information can be displayed on the navigation/multimedia system.

Navigation/multimedia system

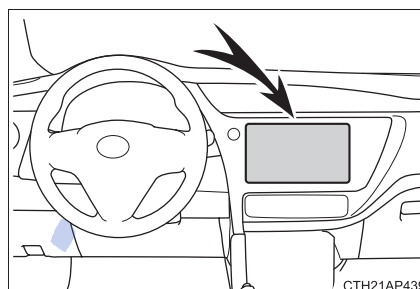

امداد خودرو فارما

تلفن شبانه روزی: ۰۲۱-۸۸۸۶۲۰۸۵

FarmaSOS.com

\*: If equipped

### Trip information

- 1 Press the "CAR" button on the navigation/multimedia system.

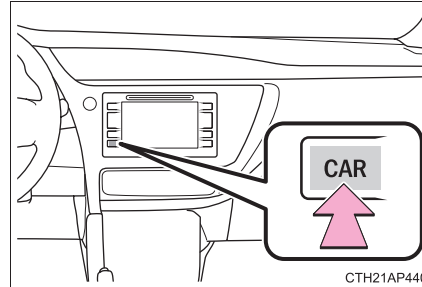

- 2 Select "Trip information".

#### ■ Trip information screen

- ① Average vehicle speed since the engine was started.
- ② Cruising range (→P. 114)
- ③ Fuel consumption in the past 15 minutes
- ④ Elapsed time since the engine was started.
- ⑤ Resetting the consumption data



Vehicles without a smart entry & start system:

Average fuel consumption for the past 15 minutes is divided by color into past averages and averages attained since the engine switch was last turned to the "ON" position. Use the displayed average fuel consumption as a reference.

Vehicles with a smart entry & start system:

Average fuel consumption for the past 15 minutes is divided by color into past averages and averages attained since the engine switch was last turned to IGNITION ON mode. Use the displayed average fuel consumption as a reference.

The image is an example only.

### Past record

- 1 Press the “CAR” button on the navigation/multimedia system.

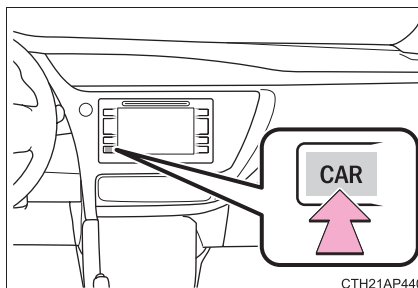

- 2 Select “Past record”.

#### ■ Past record screen

- ① Best recorded fuel consumption
- ② Previous fuel consumption record
- ③ Average fuel consumption
- ④ Updating the average fuel consumption data
- ⑤ Resetting the past record data

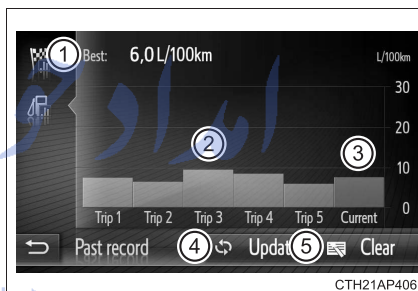

The average fuel consumption history is divided by color into past averages and the average fuel consumption since the last updated. Use the displayed average fuel consumption as a reference.

The image is an example only.

#### ■ Updating the past record data

Update the average fuel consumption by selecting “Update” to measure the current fuel consumption again.

#### ■ Resetting the data

The fuel consumption data can be deleted by selecting “Clear”.

#### ■ Cruising range

Displays the estimated maximum distance that can be driven with the quantity of fuel remaining.

This distance is computed based on your average fuel consumption.

As a result, the actual distance that can be driven may differ from that displayed.

## Operation of each component

### 3

<b>3-1. Key information</b>	
Keys.....	116
<b>3-2. Opening, closing and locking the doors</b>	
Doors .....	127
Trunk.....	133
Smart entry & start system .....	138
<b>3-3. Adjusting the seats</b>	
Front seats.....	155
Rear seats .....	156
Head restraints .....	159
<b>3-4. Adjusting the steering wheel and mirrors</b>	
Steering wheel .....	161
Inside rear view mirror .....	163
Outside rear view mirrors.....	166
<b>3-5. Opening and closing the windows</b>	
Power windows.....	169

FarmaSOS.com

## Keys

### The keys

The following keys are provided with the vehicle.

► Type A

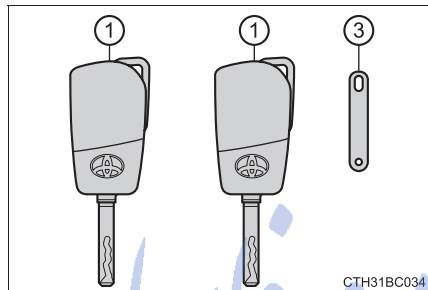

► Type B

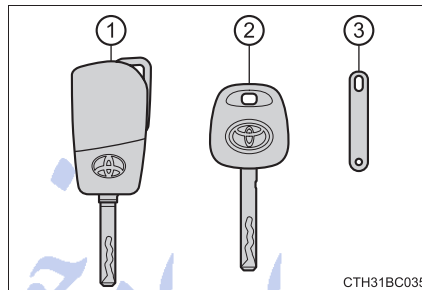

► Type C

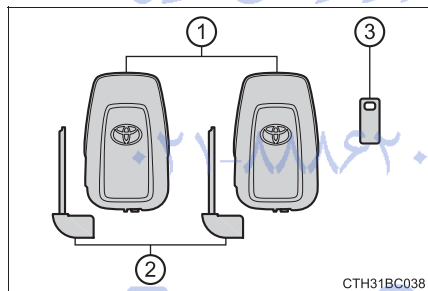

- ① Electronic keys
  - Operating the smart entry & start system (→P. 138)
  - Operating the wireless remote control function (→P. 117)
- ② Mechanical keys
- ③ Key number plate



**Wireless remote control**

▶ Vehicles without a smart entry & start system

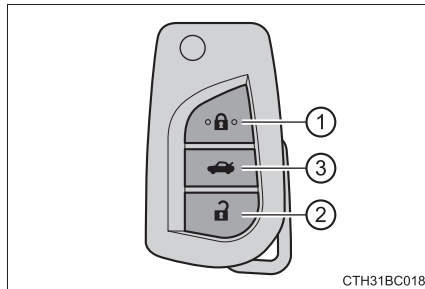

▶ Vehicles with a smart entry & start system

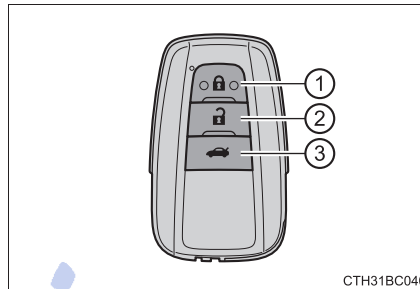

- ① Locks all the doors (→P. 127)
- ② Unlocks all the doors (→P. 127)
- ③ Opens the trunk (→P. 134)

**Using the key**

- ① Releasing  
To release the key, press the button.
- ② Folding  
To stow the key back in its case, push the key back to the stowed position while pressing the button.

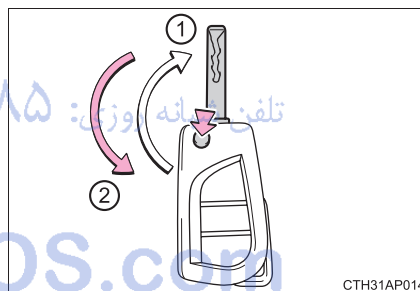

3

Operation of each component

**Using the mechanical key**

To take out the mechanical key, slide the release lever and take the key out.

The mechanical key can only be inserted in one direction, as the key only has grooves on one side. If the key cannot be inserted in a lock cylinder, turn it over and re-attempt to insert it.

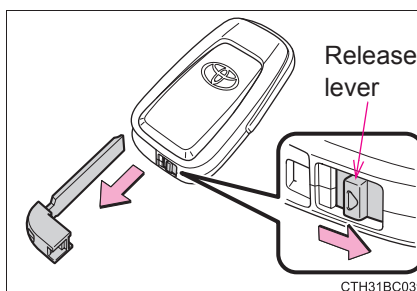

After using the mechanical key, store it in the electronic key. Carry the mechanical key together with the electronic key. If the electronic key battery is depleted or the entry function does not operate properly, you will need the mechanical key. (→P. 575)

**■ If you lose your keys**

New genuine keys can be made by any authorized Toyota dealer or repairer, or another duly qualified and equipped professional using the other key (type A and type B) or mechanical key (type C) and the key number stamped on your key number plate. Keep the plate in a safe place such as your wallet, not in the vehicle.

**■ When riding in an aircraft**

When bringing a key with wireless remote control function onto an aircraft, make sure you do not press any button on the key while inside the aircraft cabin. If you are carrying the key in your bag etc., ensure that the buttons are not likely to be pressed accidentally. Pressing a button may cause the key to emit radio waves that could interfere with the operation of the aircraft.

FarmaSOS.com

### ■ Key battery depletion

#### ▶ Vehicles without a smart entry & start system

If the wireless remote control function does not operate, the battery may be depleted. Replace the battery when necessary. (→P. 480)

#### ▶ Vehicles with a smart entry & start system

- The standard battery life is 1 to 2 years.
- If the battery becomes low, an alarm will sound in the cabin when the engine stops. (→P. 520)
- As the electronic key always receives radio waves, the battery will become depleted even if the electronic key is not used. The following symptoms indicate that the electronic key battery may be depleted. Replace the battery when necessary. (→P. 480)
  - The smart entry & start system or the wireless remote control does not operate.
  - The detection area becomes smaller.
  - The LED indicator on the key surface does not turn on.
- To avoid serious deterioration, do not leave the electronic key within 1 m (3 ft.) of the following electrical appliances that produce a magnetic field:
  - TVs
  - Personal computers
  - Cellular phones, cordless phones and battery chargers
  - Recharging cellular phones or cordless phones
  - Table lamps
  - Induction cookers

### ■ Replacing the battery

→P. 480

### ■ Confirmation of the registered key number (vehicles with a smart entry & start system)

The number of keys already registered to the vehicle can be confirmed. Ask any authorized Toyota dealer or repairer, or another duly qualified and equipped professional for details.

### ■ If a wrong key is used (vehicles with a smart entry & start system)

The key cylinder rotates freely to isolate inside mechanism.

### ■ Customization

Settings (e.g. wireless remote control system) can be changed.  
(Customizable features: →P. 611)

■ Certification for the wireless remote control (type A)



Comfort and Driving Assistance Systems

Declaration of Conformity  
in accordance with 1999/5/EC (R&TTE Directive)

We,

Manufacturer: Valeo Comfort and Driving Assistance  
Address: 76, rue Auguste Perret  
F-94046 Créteil - Cedex  
France

hereby declare under our sole responsibility that the product:

Product name: RF Transmitter (Jack Knife Key)  
Model No.: A03TAA

to which this declaration relates, complies with the essential protection requirements of R&TTE Directive (1999/5/ EC).  
The product is compliant with the following standards and/or normative documents:

- Efficient use of radio spectrum: EN 300 220-1 V2.3.1 (2010-02), EN 300 220-2 V2.3.1 (2010-02)
- Electromagnetic compatibility: EN 301 489-1 V1.8.1 (2008-04), EN 301 489-3 V1.4.1 (2002-08)
- Electrical Safety: EN 60950-1: 2006 + A11:2009 + A1:2010

CE marking:

CE 0682

Créteil, November the 20th of 2014

  
Jérôme Hugot  
Certification & Regulation

Česky [Czech]	Valeo Comfort and Driving Assistance tímto prohlašuje, že tento A03TAA je ve shodě se základními požadavky a dalšími příslušnými ustanoveními směrnice 1999/5/ES.
Hrvatski [Croatian]	Ovime, Valeo Comfort and Driving Assistance izjavljuje da je model A03TAA je u skladu sa osnovnim zahtjevima i drugim relevantnim odredbama Direktive 1999/5/EC.
Dansk [Danish]	Undertegnede Valeo Comfort and Driving Assistance erklærer herved, at følgende udstyr A03TAA overholder de væsentlige krav og øvrige relevante krav i direktiv 1999/5/EF.
Deutsch [German]	Hiermit erkläre Valeo Comfort and Driving Assistance, dass sich das Model A03TAA in Übereinstimmung mit den grundlegenden Anforderungen und den übrigen einschlägigen Bestimmungen der Richtlinie 1999/5/EG
Eesti [Estonian]	Käesolevaga kinnitab Valeo Comfort and Driving Assistance seadme A03TAA vastavust direktiivi 1999/5/EÜ põhinõuetele ja nimetatud direktiivist tulenevatele teistele asjakohastele sätetele.
English	Hereby, Valeo Comfort and Driving Assistance declares that the model A03TAA is in compliance with the essential requirements and other relevant provisions of Directive 1999/5/EC.
Español [Spanish]	Por medio de la presente Valeo Comfort and Driving Assistance declara que A03TAA cumple con los requisitos esenciales y cualesquiera otras disposiciones aplicables o exigibles de la Directiva 1999/5/CE.
Ελληνική [Greek]	Με την παρούσα Valeo Comfort and Driving Assistance δηλώνει ότι A03TAA συμμορφώνεται προς τις ουσιαστικές απαιτήσεις και τις λοιπές σχετικές διατάξεις της οδηγίας 1999/5/EK.
Français [French]	Par la présente Valeo Comfort and Driving Assistance déclare que les appareils modèle A03TAA sont conformes aux exigences essentielles et aux autres dispositions pertinentes de la directive 1999/5/CE.
Italiano [Italian]	Con la presente Valeo Comfort and Driving Assistance dichiara che questo A03TAA è conforme ai requisiti essenziali ed alle altre disposizioni pertinenti stabilite dalla direttiva 1999/5/CE.
Latviski [Latvian]	Ar šo Valeo Comfort and Driving Assistance deklarē, ka A03TAA atbilst Direktīvas 1999/5/EK būtiskajām prasībām un citiem ar to saistītajiem noteikumiem.
Lietuvių [Lithuanian]	Šiuo Valeo Comfort and Driving Assistance deklaruoja, kad šis A03TAA atitinka esminius reikalavimus ir kitas 1999/5/EB Direktyvos nuostatas.
Nederlands [Dutch]	Hierbij verklaart Valeo Comfort and Driving Assistance dat het toestel A03TAA in overeenstemming is met de essentiële eisen en de andere relevante bepalingen van richtlijn 1999/5/EG.
Malti [Maltese]	Hawnhekk, Valeo Comfort and Driving Assistance, jiddikjara li dan A03TAA jikkonforma mal-ħtiġijiet essenzjali u ma provvedimenti oħrajn rilevanti li hemm fid-Direttiva 1999/5/EC.
Magyar [Hungarian]	Alulírott, Valeo Comfort and Driving Assistance nyilatkozom, hogy a A03TAA megfelel a vonatkozó alapvető követelményeknek és az 1999/5/EC irányelv egyéb előírásainak.

Polski [Polish]	Niniejszym Valeo Comfort and Driving Assistance oświadcza, że A03TAA jest zgodny z zasadniczymi wymogami oraz pozostałymi stosownymi postanowieniami Dyrektywy 1999/5/EC.
Português [Portuguese]	Valeo Comfort and Driving Assistance declara que este A03TAA está conforme com os requisitos essenciais e outras disposições da Directiva 1999/5/CE.
Slovensko [Slovenian]	Valeo Comfort and Driving Assistance izjavlja, da je ta A03TAA v skladu z bistvenimi zahtevami in ostalimi relevantnimi določili direktive 1999/5/ES.
Slovenský [Slovak]	Valeo Comfort and Driving Assistance týmto vyhlasuje, že A03TAA spĺňa základné požiadavky a všetky príslušné ustanovenia Smernice 1999/5/ES.
Suomi [Finnish]	Valeo Comfort and Driving Assistance vakuuttaa täten että A03TAA tyyppinen laite on direktiivin 1999/5/EY oleellisten vaatimusten ja sitä koskevien direktiivin muiden ehtojen mukainen.
Svenska [Swedish]	Härmed intygar Valeo Comfort and Driving Assistance att denna A03TAA står i överensstämmelse med de väsentliga egenskapskrav och övriga relevanta bestämmelser som framgår av direktiv 1999/5/EG.
Íslenska [Icelandic]	Hér með lýsir Valeo Comfort and Driving Assistance yfir því að A03TAA er í samræmi við grunnkröfur og aðrar kröfur, sem gerðar eru í tilskipun 1999/5/EC.
Norsk [Norwegian]	Valeo Comfort and Driving Assistance erklærer herved at utstyret A03TAA er i samsvar med de grunnleggende krav og øvrige relevante krav i direktiv 1999/5/EF.
Crnogorski jezik [Montenegrin]	Ovime, Valeo Comfort and Driving Assistance izjavljuje da je model A03TAA je u skladu sa osnovnim zahtjevima i drugim relevantnim odredbama Direktive 1999/5/EC.
српски [Serbian]	Овиме, Valeo Comfort and Driving Assistance изјављује да је А03ТАА модел је у складу са основним захтевима и другим релевантним одредбама Директиве 1999/5/ЕУ.

FarmaSOS.com



Comfort and Driving Assistance Systems

## Declaration of Conformity

in accordance with 1999/5/EC (R&TTE Directive)

We,

Manufacturer: Valeo Comfort and Driving Assistance

Address: 76, rue Auguste Perret  
F-94046 Créteil - Cedex  
France

hereby declare under our sole responsibility that the product:

Product name: RF Receiver

Model No.: A03RAA

to which this declaration relates, complies with the essential protection requirements of R&TTE Directive (1999/5/EC).  
The product is compliant with the following standards and/or normative documents:

- Efficient use of radio spectrum: EN 300 220-1 V2.3.1 (2010-02), EN 300 220-2 V2.3.1 (2010-02)
- Electromagnetic compatibility: EN 301 489-1 V1.8.1 (2008-04), EN 301 489-3 V1.4.1 (2002-08)
- Electrical Safety: EN 60950-1: 2006 + A11:2009

CE marking:



Créteil, November the 20th of 2014

Jérôme Hugot  
Certification & Regulation

3

Operation of each component

Česky [Czech]	Valeo Comfort and Driving Assistance tímto prohlašuje, že tento A03RAA je ve shodě se základními požadavky a dalšími příslušnými ustanoveními směrnice 1999/5/ES.
Hrvatski [Croatian]	Ovime, Valeo Comfort and Driving Assistance izjavljuje da je model A03RAA je u skladu sa osnovnim zahtjevima i drugim relevantnim odredbama Direktive 1999/5/EC.
Dansk [Danish]	Undertegnede Valeo Comfort and Driving Assistance erklærer herved, at følgende udstyr A03RAA overholder de væsentlige krav og øvrige relevante krav i direktiv 1999/5/EF.
Deutsch [German]	Hiermit erkläre Valeo Comfort and Driving Assistance, dass sich das Model A03RAA in Übereinstimmung mit den grundlegenden Anforderungen und den übrigen einschlägigen Bestimmungen der Richtlinie 1999/5/EG
Eesti [Estonian]	Käesolevaga kinnitab Valeo Comfort and Driving Assistance seadme A03RAA vastavust direktiivi 1999/5/EÜ põhinõuetele ja nimetatud direktiivist tulenevatele teistele asjakohastele sätetele.
English	Hereby, Valeo Comfort and Driving Assistance declares that the model A03RAA is in compliance with the essential requirements and other relevant provisions of Directive 1999/5/EC.
Español [Spanish]	Por medio de la presente Valeo Comfort and Driving Assistance declara que A03RAA cumple con los requisitos esenciales y cualesquiera otras disposiciones aplicables o exigibles de la Directiva 1999/5/CE.
Ελληνική [Greek]	Με την παρούσα Valeo Comfort and Driving Assistance δηλώνει ότι A03RAA συμμορφώνεται προς τισ ουσιαστικα απαιτησεις και τισ λοιπες σχετικες διαταξεις της οδηγιας 1999/5/EK.
Français [French]	Par la présente Valeo Comfort and Driving Assistance déclare que les appareils modèle A03RAA sont conformes aux exigences essentielles et aux autres dispositions pertinentes de la directive 1999/5/CE.
Italiano [Italian]	Con la presente Valeo Comfort and Driving Assistance dichiara che questo A03RAA è conforme ai requisiti essenziali ed alle altre disposizioni pertinenti stabilite dalla direttiva 1999/5/CE.
Latviski [Latvian]	Ar šo Valeo Comfort and Driving Assistance deklarē, ka A03RAA atbilst Direktīvas 1999/5/EK būtiskajām prasībām un citiem ar to saistītajiem noteikumiem.
Lietuvių [Lithuanian]	Šiuo Valeo Comfort and Driving Assistance deklaruoja, kad šis A03RAA atitinka esminius reikalavimus ir kitas 1999/5/EB Direktyvos nuostatas.
Nederlands [Dutch]	Hierbij verklaart Valeo Comfort and Driving Assistance dat het toestel A03RAA in overeenstemming is met de essentiële eisen en de andere relevante bepalingen van richtlijn 1999/5/EG.
Malti [Maltese]	Hawnhekk, Valeo Comfort and Driving Assistance, jiddikjara li dan A03RAA jikkonforma mal-htigijiet essenzjali u ma provvedimenti oħrajn rilevanti li hemm fid-Dirrettiva 1999/5/EC.
Magyar [Hungarian]	Alulírott, Valeo Comfort and Driving Assistance nyilatkozom, hogy a A03RAA megfelel a vonatkozó alapvető követelményeknek és az 1999/5/EC irányelv egyéb előírásainak.



Polski [Polish]	Niniejszym Valeo Comfort and Driving Assistance oświadcza, że A03RAA jest zgodny z zasadniczymi wymogami oraz pozostałymi stosownymi postanowieniami Dyrektywy 1999/5/EC.
Português [Portuguese]	Valeo Comfort and Driving Assistance declara que este A03RAA está conforme com os requisitos essenciais e outras disposições da Directiva 1999/5/CE.
Slovensko [Slovenian]	Valeo Comfort and Driving Assistance izjavlja, da je ta A03RAA v skladu z bistvenimi zahtevami in ostalimi relevantnimi določili direktive 1999/5/ES.
Slovenský [Slovak]	Valeo Comfort and Driving Assistance týmto vyhlasuje, že A03RAA spĺňa základné požiadavky a všetky príslušné ustanovenia Smernice 1999/5/ES.
Suomi [Finnish]	Valeo Comfort and Driving Assistance vakuuttaa täten että A03RAA tyyppinen laite on direktiivin 1999/5/EY oleellisten vaatimusten ja sitä koskevien direktiivin muiden ehtojen mukainen.
Svenska [Swedish]	Härmed intygar Valeo Comfort and Driving Assistance att denna A03RAA står i överensstämmelse med de väsentliga egenskapskrav och övriga relevanta bestämmelser som framgår av direktiv 1999/5/EG.
Íslenska [Icelandic]	Hér með lýsir Valeo Comfort and Driving Assistance yfir því að A03RAA er í samræmi við grunnkröfur og aðrar kröfur, sem gerðar eru í tilskipun 1999/5/EC.
Norsk [Norwegian]	Valeo Comfort and Driving Assistance erklærer herved at utstyret A03RAA er i samsvar med de grunnleggende krav og øvrige relevante krav i direktiv 1999/5/EF.
Crnogorski jezik [Montenegrin]	Ovime, Valeo Comfort and Driving Assistance izjavljuje da je model A03RAA je u skladu sa osnovnim zahtjevima i drugim relevantnim odredbama Direktive 1999/5/EC.
српски [Serbian]	Овиме, Valeo Comfort and Driving Assistance изјављује да је А03РАА модел је у складу са основним захтевима и другим релевантним одредбама Директиве 1999/5/ЕУ.

FarmaSOS.com

 NOTICE**■ To prevent key damage**

- Do not drop the keys, subject them to strong shocks or bend them.
- Do not expose the keys to high temperatures for long periods of time.
- Do not get the keys wet or wash them in an ultrasonic washer etc.
- Do not attach metallic or magnetic materials to the keys or place the keys close to such materials.
- Do not disassemble the keys.
- Do not attach a sticker or anything else to the surface of the electronic key and key.
- Vehicles with a smart entry & start system: Do not place the keys near objects that produce magnetic fields, such as TVs, audio systems and induction cookers, or medical electrical equipment, such as low-frequency therapy equipment.

**■ Carrying the electronic key on your person (vehicles with a smart entry & start system)**

Carry the electronic key 10 cm (3.9 in.) or more away from electric appliances that are turned on. Radio waves emitted from electric appliances within 10 cm (3.9 in.) of the electronic key may interfere with the key, causing the key to not function properly.

**■ In case of a smart entry & start system malfunction or other key-related problems (vehicles with a smart entry & start system)**

Take your vehicle with all the electronic keys provided with your vehicle to any authorized Toyota dealer or repairer, or another duly qualified and equipped professional.

**■ When an electronic key is lost (vehicles with a smart entry & start system)**

If the electronic key remains lost, the risk of vehicle theft increases significantly. Visit any authorized Toyota dealer or repairer, or another duly qualified and equipped professional immediately with all remaining electronic keys that was provided with your vehicle.

## Doors

### Unlocking and locking the doors from the outside (front door handles only)

#### ◆ Smart entry & start system (if equipped)

Carry the electronic key to enable this function.

- ① Grip the handle to unlock all the doors.

Make sure to touch the sensor on the back of the handle.

The doors cannot be unlocked for 3 seconds after the doors are locked.

- ② Touch the lock sensor (the indentation on the upper part of the door handle) to lock all the doors.

Check that the door is securely locked.

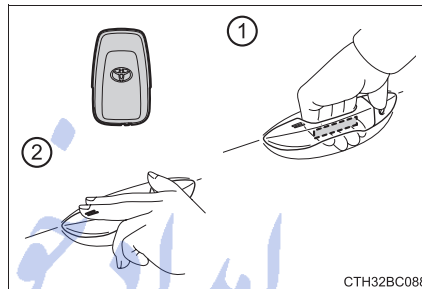

#### ◆ Wireless remote control

- ▶ Vehicles without a smart entry & start system

- ▶ Vehicles with a smart entry & start system

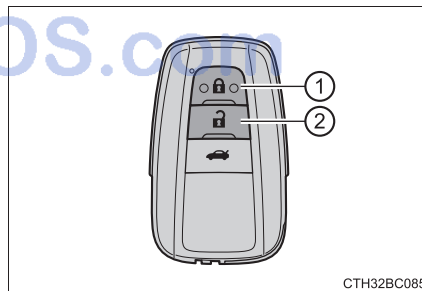
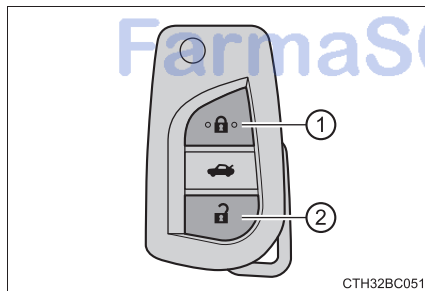

- ① Locks all the doors

- ② Unlocks all the doors

After pressing the lock button, check that the door is securely locked.

◆ **Key**

Turning the key operates the doors as follows:

▶ Vehicles without a smart entry & start system

- ① Locks all the doors
- ② Unlocks all the doors

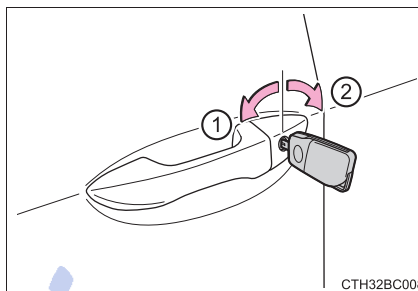

▶ Vehicles with a smart entry & start system

The doors can also be locked and unlocked with the mechanical key. (→P. 575)

■ **Operation signals**

The emergency flashers flash to indicate that the doors have been locked/unlocked. (Locked: Once; Unlocked: Twice)

■ **Security feature**

▶ Vehicles without a smart entry & start system

If a door is not opened within approximately 30 seconds after the vehicle is unlocked, the security feature automatically locks the vehicle again.

▶ Vehicles with a smart entry & start system

If a door is not opened within approximately 30 seconds after the vehicle is unlocked, the security feature automatically locks the vehicle again. (However, depending on the location of the electronic key, the key may be detected as being in the vehicle. In this case, vehicle may be unlocked.)

**■ When the door cannot be locked by the lock sensor on the upper part of the door handle (vehicles with a smart entry & start system)**

If the door will not lock even when the top-side sensor area is touched, try using your palm to touch the lock sensor.

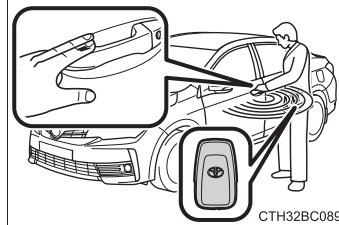
**■ Door lock buzzer (vehicles with a smart entry & start system)**

If an attempt to lock the doors is made when a door is not fully closed, a buzzer sounds continuously. Fully close the door to stop the buzzer, and lock the vehicle once more.

**■ If the smart entry & start system or the wireless remote control does not operate properly**

Use the mechanical key to lock and unlock the doors. (→P. 575)

Replace the battery with a new one if it is depleted. (→P. 480)

تلفن شبانه روزی: ۰۲۱-۸۸۶۲۰۸۵

FarmaSOS.com

### Unlocking and locking the doors from the inside

#### ◆ Door lock switches (if equipped)

- ① Locks all the doors
- ② Unlocks all the doors

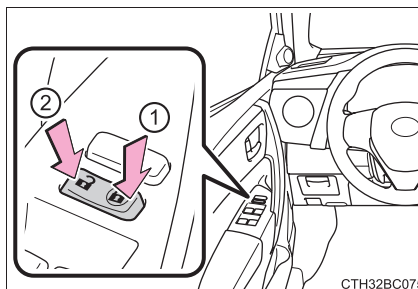

#### ◆ Inside lock buttons

- ① Locks the door
- ② Unlocks the door

The driver's door and front passenger's door can be opened by pulling the inside handle even if the lock button is in the lock position.

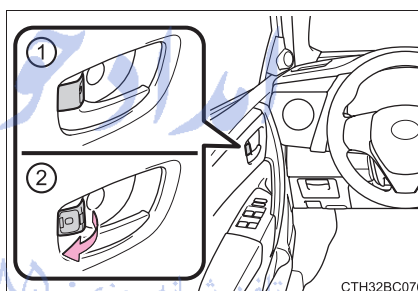

### Locking the front doors from the outside without a key

- 1 Move the inside lock button to the lock position.
  - 2 Close the door while pulling the door handle.
- ▶ Vehicles without a smart entry & start system

The door cannot be locked if the key is in the engine switch.

- ▶ Vehicles with a smart entry & start system

The door cannot be locked if the engine switch is in ACCESSORY or IGNITION ON mode, or the electronic key is left inside the vehicle.

The key may not be detected correctly and the door may be locked.

**Rear door child-protector lock**

The door cannot be opened from inside the vehicle when the lock is set.

- ① Unlock
- ② Lock

These locks can be set to prevent children from opening the rear doors. Push down on each rear door switch to lock both rear doors.



3

Operation of each component

تلفن شبانه روزی: ۰۲۱-۸۸۸۶۲۰۸۵

FarmaSOS.com

### ■ Conditions affecting the operation of the smart entry & start system or wireless remote control

#### ▶ Vehicles without a smart entry & start system

The wireless remote control function may not operate normally in the following situations:

- When the wireless key battery is depleted
- Near a TV tower, radio station, electric power plant, airport or other facility that generates strong radio waves
- When carrying a portable radio, cellular phone or other wireless communication devices
- When multiple wireless keys are in the vicinity
- When the wireless key is in contact with, or is covered by a metallic object
- When a wireless key (that emits radio waves) is being used nearby
- When the wireless key has been left near an electrical appliance such as a personal computer
- If window tint with a metallic content or metallic objects are attached to the rear window

#### ▶ Vehicles with a smart entry & start system

→P. 142

### ▲ WARNING

#### ■ To prevent an accident

Observe the following precautions while driving the vehicle. Failure to do so may result in a door opening and an occupant falling out, resulting in death or serious injury.

- Always use a seat belt.
- Ensure that all doors are properly closed.
- Do not pull the inside handle of the doors while driving.  
The doors may be opened and the passengers are thrown out of the vehicle and it may result in serious injury or death.  
Be especially careful for the driver's door and front passenger's door, as the door may be opened even if the inside lock button is in the locked position.
- Set the rear door child-protector locks when children are seated in the rear seats.



## Trunk

The trunk can be opened using the trunk opener, entry function (if equipped) or wireless remote control.

### Opening the trunk from inside the vehicle

Pull the lever upward to release the trunk lid.

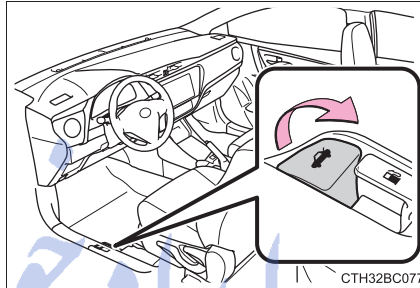

### Opening the trunk from outside the vehicle

#### ◆ Smart entry & start system (if equipped)

While carrying the electronic key, press the button on the trunk lid.

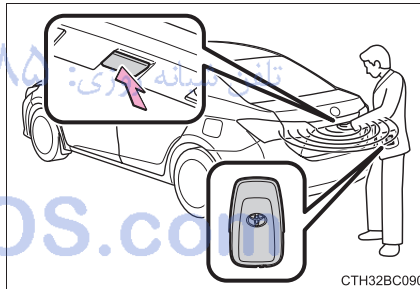

◆ **Wireless remote control**

- ▶ Vehicles without a smart entry & start system
- ▶ Vehicles with a smart entry & start system

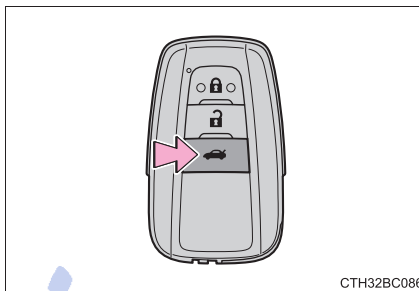
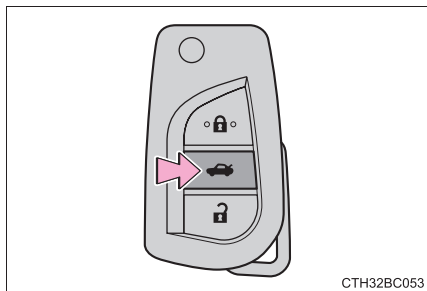

Press and hold the switch.

◆ **Trunk opener**

When the doors are unlocked, raise the trunk lid while pressing the trunk opener switch.

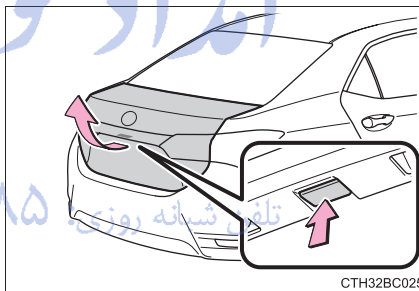

FarmaSOS.com

### When closing the trunk

Using the trunk grip, lower the trunk without applying force to the side and push the trunk down from the outside to close it.

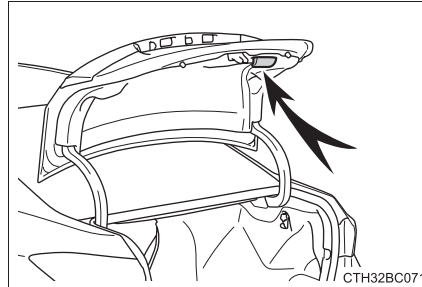

#### ■ Trunk light

The trunk light turns on when the trunk is opened.

#### ■ Function to prevent the trunk being locked with the electronic key inside (vehicles with a smart entry & start system)

- When all doors are being locked, closing the trunk lid with the electronic key left inside the trunk will sound an alarm. In this case, the trunk lid can be unlocked by pressing the trunk release button on the trunk lid.
- Even when the spare electronic key is put in the trunk with all the doors locked, the key confinement prevention function can be activated so the trunk can be unlocked. In order to prevent theft, take all electronic keys with you when leaving the vehicle.
- Even when the electronic key is put in the trunk with all the doors are locked, the key may not be detected depending on the places and the surrounding radio wave conditions. In this case, the key confinement prevention function cannot be activated, causing the doors to lock when the trunk is closed. Make sure to check where the key is before closing the trunk.
- The key confinement prevention function cannot be activated if any one of the doors is unlocked. In this case, open the trunk using the trunk opener.

#### ■ Customization

The trunk opening operation can be changed.  
(Customizable features: →P. 611)

 WARNING**■ Caution while driving**

- Keep the trunk lid closed while driving.  
If the trunk lid is left open, it may hit near-by objects while driving or luggage in the trunk may be unexpectedly thrown out, causing an accident. In addition, exhaust gases may enter the vehicle, causing death or a serious health hazard. Make sure to close the trunk lid before driving.
- Before driving the vehicle, make sure that the trunk lid is fully closed. If the trunk lid is not fully closed, it may open unexpectedly while driving, causing an accident.
- Never let anyone sit in the trunk. In the event of sudden braking or a collision, they are susceptible to death or serious injury.

**■ When a child is in the vehicle**

Observe the following precautions.

Failure to do so may result in death or serious injury.

- Do not allow a child to play in the trunk.  
If a child is accidentally locked in the trunk, the child could suffer from heat exhaustion, suffocation or other injuries.
- Do not allow a child to open or close the trunk lid.  
Doing so may cause the trunk lid to operate unexpectedly, or cause the child's hands, head, or neck to be caught by the closing trunk lid.

تلفن شبانه روزی: ۰۲۱-۸۸۸۶۲۰۸۵

FarmaSOS.com

 **WARNING**

■ **Using the trunk**

Observe the following precautions.

Failure to do so may cause parts of the body to be caught, resulting in serious injury.

- Remove any heavy loads, such as snow and ice, from the trunk lid before opening it. Failure to do so may cause the trunk lid to suddenly shut again after it is opened.
- When opening or closing the trunk lid, thoroughly check to make sure the surrounding area is safe.
- If anyone is in the vicinity, make sure they are safe and let them know that the trunk is about to open or close.
- Use caution when opening or closing the trunk lid in windy weather as it may move abruptly in strong wind.
- The trunk lid may suddenly shut if it is not opened fully. It is more difficult to open or close the trunk lid on an incline than on a level surface, so beware of the trunk lid unexpectedly opening or closing by itself. Make sure that the trunk lid is fully open and secure before using the trunk.
- When closing the trunk lid, take extra care to prevent your fingers etc. from being caught.
- When closing the trunk lid, make sure to press it lightly on its outer surface. If the trunk handle is used to fully close the trunk lid, it may result in hands or arms being caught.
- Do not attach any accessories other than genuine Toyota parts to the trunk lid. Such additional weight on the trunk lid may cause the lid to suddenly shut again after it is opened.

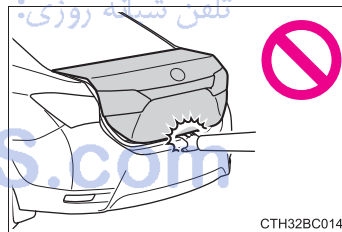
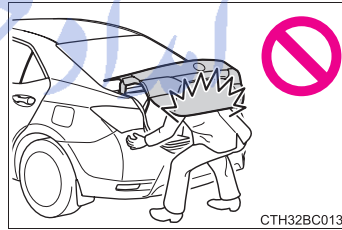

## Smart entry & start system\*

The following operations can be performed simply by carrying the electronic key on your person, for example in your pocket. (The driver should always carry the electronic key.)

- Locks and unlocks the doors (→P. 127)
- Opens the trunk (→P. 133)
- Starts the engine (→P. 199)

### ■ Antenna location

- ① Antennas outside the cabin
- ② Antennas inside the cabin
- ③ Antenna inside the trunk
- ④ Antenna outside the trunk

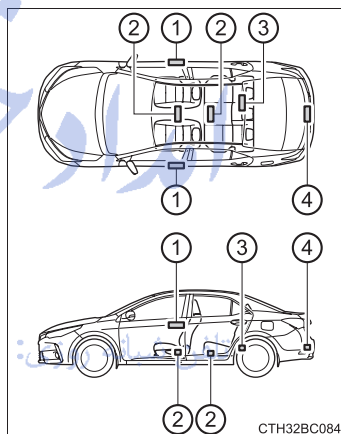

FarmaSOS.com

\*: If equipped

### ■ Effective range (areas within which the electronic key is detected)

- When locking or unlocking the doors

The system can be operated when the electronic key is within about 0.7 m (2.3 ft.) of either of the outside front door handles. (Only the doors detecting the key can be operated.)

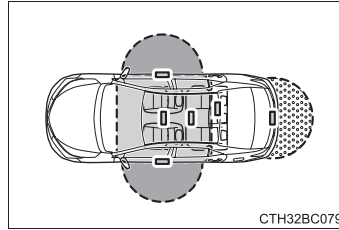

- When starting the engine or changing engine switch modes

The system can be operated when the electronic key is inside the vehicle.

- When opening the trunk

The system can be operated when the electronic key is within about 0.7 m (2.3 ft.) of the trunk release button.

### ■ Alarms and warning indicators

- ▶ Vehicles with a drive monitor display

A combination of exterior and interior alarms as well as warning lights are used to prevent theft of the vehicle and unforeseeable accidents resulting from erroneous operation. Take appropriate measures for the warning light that comes on. (→P. 520)

- ▶ Vehicles with a multi-information display

A combination of exterior and interior alarms as well as warning messages shown on the multi-information display are used to prevent theft of the vehicle and accidents resulting from erroneous operation. Take appropriate measures in response to any warning message on the multi-information display. (→P. 526)

The following table describes circumstances and correction procedures when only alarms are sounded.

Alarm	Situation	Correction procedure
Exterior alarm sounds once for 5 seconds	An attempt was made to lock the vehicle while a door was open.	Close all of the doors and lock the doors again.
	Vehicles with a drive monitor display: An attempt was made to lock the doors using the smart entry & start system while the electronic key was still inside the vehicle.	Retrieve the electronic key from the passenger compartment and lock the doors again.
	The trunk was closed while the electronic key was still inside the trunk and all the doors were locked.	Retrieve the electronic key from the trunk and close the trunk lid.
Interior alarm sounds continuously	The engine switch was turned to ACCESSORY mode while the driver's door was open (or the driver's door was opened while the engine switch was in ACCESSORY mode).	Turn the engine switch off and close the driver's door.
Interior alarm pings once and exterior alarm sounds once for 5 seconds* <sup>1</sup>	An attempt was made to lock either front door by opening a door and putting the inside lock button into the lock position, then closing the door by pulling on the outside door handle with the electronic key still inside the vehicle.	Retrieve the electronic key from the vehicle and lock the doors again.
Interior alarm sounds continuously* <sup>1, 2</sup>	The driver's door was opened while any shift position other than P was selected without turning off the engine switch.	Shift the shift lever to P.

\*1: Vehicles with a drive monitor display

\*2: Vehicles with a Multidrive





### ■ Battery-saving function

The battery-saving function will be activated in order to prevent the electronic key battery and the vehicle battery from being discharged while the vehicle is not in operation for a long time.

- In the following situations, the smart entry & start system may take some time to unlock the doors.
  - The electronic key has been left in an area of approximately 2 m (6 ft.) of the outside of the vehicle for 10 minutes or longer.
  - The smart entry & start system has not been used for 5 days or longer.
- If the smart entry & start system has not been used for 14 days or longer, the doors cannot be unlocked at any doors except the driver's door. In this case, take hold of the driver's door handle, or use the wireless remote control or the mechanical key, to unlock the doors.

### ■ Electronic key battery-saving function

When battery-saving mode is set, battery depletion is minimized by stopping the electronic key from receiving radio waves.

Press  twice while pressing and holding . Confirm that the electronic key indicator flashes 4 times.

While the battery-saving mode is set, the smart entry & start system cannot be used. To cancel the function, press any of the electronic key buttons.

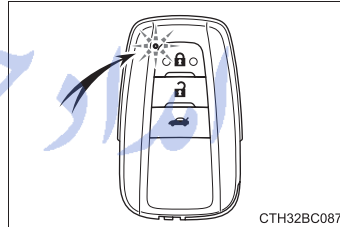

3

Operation of each component

FarmaSOS.com

**■ Conditions affecting operation**

The smart entry & start system uses weak radio waves. In the following situations, the communication between the electronic key and the vehicle may be affected, preventing the smart entry & start system, wireless remote control and engine immobilizer system from operating properly.

(Ways of coping: →P. 575)

- When the electronic key battery is depleted
- Near a TV tower, electric power plant, gas station, radio station, large display, airport or other facility that generates strong radio waves or electrical noise
- When carrying a portable radio, cellular phone, cordless phone or other wireless communication device
- When the electronic key is in contact with, or is covered by the following metallic objects
  - Cards to which aluminum foil is attached
  - Cigarette boxes that have aluminum foil inside
  - Metallic wallets or bags
  - Coins
  - Hand warmers made of metal
  - Media such as CDs and DVDs
- When other wireless keys (that emit radio waves) are being used nearby
- When carrying the electronic key together with the following devices that emit radio waves
  - Another vehicle's electronic key or a wireless key that emits radio waves
  - Personal computers or personal digital assistants (PDAs)
  - Digital audio players
  - Portable game systems
- If window tint with a metallic content or metallic objects are attached to the rear window
- When the electronic key is placed near a battery charger or electronic devices

**■ Note for the entry function**

- Even when the electronic key is within the effective range (detection areas), the system may not operate properly in the following cases:
  - The electronic key is too close to the window or outside door handle, near the ground, or in a high place when the doors are locked or unlocked.
  - The electronic key is near the ground or in a high place, or too close to the rear bumper center when the trunk is opened.
  - The electronic key is on the instrument panel, rear package tray or floor, or in the door pockets or glove box when the engine is started or engine switch modes are changed.
- Do not leave the electronic key on top of the instrument panel or near the door pockets when exiting the vehicle. Depending on the radio wave reception conditions, it may be detected by the antenna outside the cabin and the door will become lockable from the outside, possibly trapping the electronic key inside the vehicle.
- As long as the electronic key is within the effective range, the doors may be locked or unlocked by anyone. However, only the doors detecting the electronic key can be used to unlock the vehicle.
- Even if the electronic key is not inside the vehicle, it may be possible to start the engine if the electronic key is near the window.
- The doors may unlock or lock if a large amount of water splashes on the door handle, such as in the rain or in a car wash when the electronic key is within the effective range. (The doors will automatically be locked after approximately 30 seconds if the doors are not opened and closed.)
- If the wireless remote control is used to lock the doors when the electronic key is near the vehicle, there is a possibility that the door may not be unlocked by the entry function. (Use the wireless remote control to unlock the doors.)

FarmaSOS.com

■ **Note for locking the doors**

- Touching the door lock sensor while wearing gloves may delay or prevent lock operation. Remove the gloves and touch the lock sensor again.
- When the lock operation is performed using the lock sensor, recognition signals will be shown up to two consecutive times. After this, no recognition signals will be given.
- If the door handle becomes wet while the electronic key is within the effective range, the door may lock and unlock repeatedly. In that case, follow the following correction procedures to wash the vehicle:
  - Place the electronic key in a location 2 m (6 ft.) or more away from the vehicle. (Take care to ensure that the key is not stolen.)
  - Set the electronic key to battery-saving mode to disable the smart entry & start system. (→P. 141)
- Vehicles with a drive monitor display: If the electronic key is inside the vehicle and a door handle becomes wet during a car wash, a buzzer will sound outside the vehicle. To turn off the alarm, lock all the doors.
- Vehicles with a multi-information display: If the electronic key is inside the vehicle and a door handle becomes wet during a car wash, a message may be shown on the multi-information display and a buzzer will sound outside the vehicle. To turn off the alarm, lock all the doors.
- The lock sensor may not work properly if it comes into contact with ice, snow, mud, etc. Clean the lock sensor and attempt to operate it again.
- Fingernails may scrape against the door during operation of the door handle. Be careful not to injure fingernails or damage the surface of the door.

FarmaSOS.com

**■ Note for the unlocking function**

- A sudden approach to the effective range of door handle may prevent the doors from being unlocked. In this case, return the door handle to the original position and check that the doors unlock before pulling the door handle again.
- Gripping the door handle when wearing a glove may not unlock the door.
- If the door handle becomes wet while the electronic key is within the effective range, the door may lock and unlock repeatedly. In that case, follow the following correction procedures to wash the vehicle:
  - Place the electronic key in a location 2 m (6 ft.) or more away from the vehicle. (Take care to ensure that the key is not stolen.)
  - Set the electronic key to battery-saving mode to disable the smart entry & start system. (→P. 141)
- If there is another electronic key in the detection area, it may take slightly longer to unlock the doors after the door handle is gripped.
- Fingernails may scrape against the door during operation of the door handle. Be careful not to injure fingernails or damage the surface of the door.

**■ When the vehicle is not driven for extended periods**

- To prevent theft of the vehicle, do not leave the electronic key within 2 m (6 ft.) of the vehicle.
- The smart entry & start system can be deactivated in advance. (→P. 611)

**■ To operate the system properly**

Make sure to carry the electronic key when operating the system. Do not get the electronic key too close to the vehicle when operating the system from the outside of the vehicle.

Depending on the position and holding condition of the electronic key, the key may not be detected correctly and the system may not operate properly. (The alarm may go off accidentally, or the door lock prevention function may not operate.)

**■ If the smart entry & start system does not operate properly**

- Locking and unlocking the doors: Use the mechanical key. (→P. 575)
- Starting the engine: →P. 576

**■ When the electronic key battery is fully depleted**

→P. 480

**■ Customization**

Settings (e. g. smart entry & start system) can be changed.  
(Customizable features: →P. 611)

**■ If the smart entry & start system has been deactivated in a customized setting**

- Locking and unlocking the doors:  
Use the wireless remote control or mechanical key. (→P. 127, 575)
- Starting the engine and changing engine switch modes: →P. 576
- Stopping the engine: →P. 201

■ Certification for the smart entry & start system

**TOKAI RIKA**

OGUCHI-CHO, NIWA-GUN  
AICHI-KEN, 480-0195 JAPAN  
TEL: +81-587-95-0093  
FAX: +81-587-95-5471

**R&TTE Declaration of Conformity**

We,

Manufacturer's Name: TOKAI RIKA CO., LTD.

Manufacturer's Address: 3-260 Toyota, Oguchi-cho, Niwa-gun, Aichi 480-0195, Japan

hereby declare under our sole responsibility that the product:

Product Name: Electronic Key

Product Model: BT2EW -

to which this declaration relates is in conformity with the essential requirements and other relevant requirements of the R&TTE Directive (1999/5/EC). The product is compliant with the following standards and/or other normative documents:

Safety: EN60950-1:2006

EMC: EN301 489-1 V1.9.2 & EN301 489-3 V1.6.1

Spectrum: EN300 220-2 V2.4.1, EN300 330-2 V1.6.1

Supplementary information:

* Technical performance per EN300 220-1	Transmitter duty cycle 10% or less
* Technical performance per EN300 330-1	Receiver category 3
* CE mark	
* Member states intended for use	EU and EFTA
* Member states with restrictive use	None

Date:

July 30, 2015

Signature:

*Makoto Okada*

Position of the signatory:

Makoto Okada  
Project General Manager,  
Electronics Quality Control Div.

Hereby, Tokai Rika Co., Ltd., declares that this BT2EW is in compliance with the essential requirements and other relevant provisions of Directives 1999/5/EC.
Tokai Rika Co., Ltd. vakuuttaa täten että BT2EW tyyppinen laite on direktiivin 1999/5/EY oleellisten vaatimusten ja sitä koskevien direktiivin muiden ehtojen mukainen.
Hierbij verklaart Tokai Rika Co., Ltd. dat het toestel BT2EW in overeenstemming is met de essentiële eisen en de andere relevante bepalingen van richtlijn 1999/5/EG.
Par la présente Tokai Rika Co., Ltd. déclare que l'appareil BT2EW est conforme aux exigences essentielles et aux autres dispositions pertinentes de la directive 1999/5/CE.
Härmed intygar Tokai Rika Co., Ltd. att denna BT2EW står i överensstämmelse med de väsentliga egenskapskrav och övriga relevanta bestämmelser som framgår av direktiv 1999/5/EG.
Undertegnede Tokai Rika Co., Ltd. erklærer herved, at følgende udstyr BT2EW overholder de væsentlige krav og øvrige relevante krav i direktiv 1999/5/EF.
Hiermit erklärt Tokai Rika Co., Ltd., dass sich das Gerät BT2EW in Übereinstimmung mit den grundlegenden Anforderungen und den übrigen einschlägigen Bestimmungen der Richtlinie 1999/5/EG befindet.
ΜΕ ΤΗΝ ΠΑΡΟΥΣΑ Tokai Rika Co., Ltd. ΔΗΛΩΝΕΙ ΟΤΙ ΒΤ2ΕW ΣΥΜΜΟΡΦΩΝΕΤΑΙ ΠΡΟΣ ΤΙΣ ΟΥΣΙΩΔΕΙΣ ΑΠΑΙΤΗΣΕΙΣ ΚΑΙ ΤΙΣ ΛΟΙΠΕΣ ΣΧΕΤΙΚΕΣ ΔΙΑΤΑΞΕΙΣ ΤΗΣ ΟΔΗΓΙΑΣ 1999/5/ΕΚ.
Con la presente Tokai Rika Co., Ltd. dichiara che questo BT2EW è conforme ai requisiti essenziali ed alle altre disposizioni pertinenti stabilite dalla direttiva 1999/5/CE.
Por medio de la presente Tokai Rika Co., Ltd. declara que el BT2EW cumple con los requisitos esenciales y cualesquiera otras disposiciones aplicables o exigibles de la Directiva 1999/5/CE.
Tokai Rika Co., Ltd. declara que este BT2EW está conforme com os requisitos essenciais e outras disposições da Directiva 1999/5/CE.
Hawnhekk, Tokai Rika Co., Ltd., jiddikjara li dan BT2EW jikkonforma mal-ħtiġijiet essenzjali u ma provvedimenti oħrajn rilevanti li hemm fid-Dirrettiva 1999/5/EC.
Käesolevaga kinnitab Tokai Rika Co., Ltd. seadme BT2EW vastavust direktiivi 1999/5/EÜ põhinõuetele ja nimetatud direktiivist tulenevatele teistele asjakohastele sätetele.
Alulirott, Tokai Rika Co., Ltd. nyilatkozom, hogy a BT2EW megfelel a vonatkozó alapvető követelményeknek és az 1999/5/EC irányelv egyéb előírásainak.
Tokai Rika Co., Ltd. týmto vyhlasuje, že BT2EW spĺňa základné požiadavky a všetky prislušné ustanovenia Smernice 1999/5/ES.

Tokai Rika Co., Ltd. tímto prohlašuje, že tento BT2EW je ve shodě se základními požadavky a dalšími příslušnými ustanoveními směrnice 1999/5/ES.
Tokai Rika Co., Ltd. izjavlja, da je ta BT2EW v skladu z bistvenimi zahtevami in ostalimi relevantnimi določili direktive 1999/5/ES.
Šiuo Tokai Rika Co., Ltd. deklaruoja, kad šis BT2EW atitinka esminius reikalavimus ir kitas 1999/5/EB Direktyvos nuostatas.
Ar šo Tokai Rika Co., Ltd. deklarē, ka BT2EW atbilst Direktīvas 1999/5/EK būtiskajām prasībām un citiem ar to saistītajiem noteikumiem.
Niniejszym Tokai Rika Co., Ltd. oświadcza, że BT2EW jest zgodny z zasadniczymi wymogami oraz pozostałymi stosownymi postanowieniami Dyrektywy 1999/5/EC.
Hér með lýsir Tokai Rika Co., Ltd. yfir því að BT2EW er í samræmi við grunnkröfur og aðrar kröfur, sem gerðar eru í tilskipun 1999/5/EC.
Tokai Rika Co., Ltd. erklærer herved at utstyret BT2EW er i samsvar med de grunnleggende krav og øvrige relevante krav i direktiv 1999/5/EF.
С настоящето, Tokai Rika Co., Ltd., декларира, че BT2EW е в съответствие със съществените изисквания и другите приложими разпоредби на Директива 1999/5/EC.
Prin prezenta, Tokai Rika Co., Ltd., declară că aparatul BT2EW este în conformitate cu cerințele esențiale și cu alte prevederi pertinente ale Directivei 1999/5/CE.
Ovim, Tokai Rika Co., Ltd., izjavljuje da ovaj BT2EW je usklađen sa bitnim zahtjevima i drugim relevantnim odredbama Direktive 1999/5/EC.
Nepermjet kesaj, Tokai Rika Co., Ltd., deklaroj qe ky BT2EW eshte ne pajtim me kerkesat thelbesore dhe dispozitat e tjera perkatese te Direktives 1999/5/EC.
Ovim Tokai Rika Co., Ltd., izjavljuje da je BT2EW u skladu s bitnim zahtjevima i drugim relevantnim odredbama Direktive 1999/5/EC i Pravilnika o RiTT opremi (NN 25/2012).
Ovim, Tokai Rika Co., Ltd., deklariše da je BT2EW u skladu sa osnovnim zahtevima i ostalim relevantnim odredbama Direktive 1999/5/EC.
Işbu belge ile Tokai Rika Co., Ltd., bu BT2EW ürününün 1999/5/EC Yönetmeliği'nin temel gerekliliklerine ve diğer ilgili hükümlerine uygun olduğunu beyan eder.
The DECLARATION of CONFORMITY (DoC) is available at the following address: <a href="http://www.tokai-rika.co.jp/pc">http://www.tokai-rika.co.jp/pc</a>



И 005 15



Hereby, TRCZ s.r.o., declares that this B94UM is in compliance with the essential requirements and other relevant provisions of Directives 1999/5/EC.
TRCZ s.r.o. vakuuttaa täten että B94UM tyyppinen laite on direktiivin 1999/5/EY oleellisten vaatimusten ja sitä koskevien direktiivin muiden ehtojen mukainen.
Hierbij verklaart TRCZ s.r.o. dat het toestel B94UM in overeenstemming is met de essentiële eisen en de andere relevante bepalingen van richtlijn 1999/5/EG.
Par la présente TRCZ s.r.o. déclare que l'appareil B94UM est conforme aux exigences essentielles et aux autres dispositions pertinentes de la directive 1999/5/CE.
Härmed intygar TRCZ s.r.o. att denna B94UM står i överensstämmelse med de väsentliga egenskapskrav och övriga relevanta bestämmelser som framgår av direktiv 1999/5/EG.
Undertegnede TRCZ s.r.o. erklærer herved, at følgende udstyr B94UM overholder de væsentlige krav og øvrige relevante krav i direktiv 1999/5/EF.
Hiermit erklärt TRCZ s.r.o., dass sich das Gerät B94UM in Übereinstimmung mit den grundlegenden Anforderungen und den übrigen einschlägigen Bestimmungen der Richtlinie 1999/5/EG befindet.
ΜΕ ΤΗΝ ΠΑΡΟΥΣΑ TRCZ s.r.o. ΔΗΛΩΝΕΙ ΟΤΙ Β94UM ΣΥΜΜΟΡΦΩΝΕΤΑΙ ΠΡΟΣ ΤΙΣ ΟΥΣΙΩΔΕΙΣ ΑΠΑΙΤΗΣΕΙΣ ΚΑΙ ΤΙΣ ΛΟΙΠΕΣ ΣΧΕΤΙΚΕΣ ΔΙΑΤΑΞΕΙΣ ΤΗΣ ΟΔΗΓΙΑΣ 1999/5/ΕΚ.
Con la presente TRCZ s.r.o. dichiara che questo B94UM è conforme ai requisiti essenziali ed alle altre disposizioni pertinenti stabilite dalla direttiva 1999/5/CE.
Por medio de la presente TRCZ s.r.o. declara que el B94UM cumple con los requisitos esenciales y cualesquiera otras disposiciones aplicables o exigibles de la Directiva 1999/5/CE.
TRCZ s.r.o. declara que este B94UM está conforme com os requisitos essenciais e outras disposições da Directiva 1999/5/CE.
Hawnhekk, TRCZ s.r.o., jiddikjara li dan B94UM jikkonforma mal-ħtigijiet essenzjali u ma provvedimenti oħrajn relevanti li hemm fid-Direttiva 1999/5/EC.
Käesolevaga kinnitab TRCZ s.r.o. seadme B94UM vastavust direktiivi 1999/5/EÜ põhinõuetele ja nimetatud direktiivist tulenevatele teistele asjakohastele sätetele.
Alulírott, TRCZ s.r.o. nyilatkozom, hogy a B94UM megfelel a vonatkozó alapvető követelményeknek és az 1999/5/EC irányelv egyéb előírásainak.
TRCZ s.r.o. týmto vyhlasuje, že B94UM splňa základné požiadavky a všetky príslušné ustanovenia Smernice 1999/5/ES.
TRCZ s.r.o. tímto prohlašuje, že tento B94UM je ve shodě se základními požadavky a dalšími příslušnými ustanoveními směrnice 1999/5/ES.
TRCZ s.r.o. izjavlja, da je ta B94UM v skladu z bistvenimi zahtevami in ostalimi relevantnimi določili direktive 1999/5/ES.
Šiuo TRCZ s.r.o. deklaruoja, kad šis B94UM atitinka esminius reikalavimus ir kitas 1999/5/EB Direktyvos nuostatas.

Ar šo TRCZ s.r.o. deklarē, ka B94UM atbilst Direktīvas 1999/5/EK būtiskajām prasībām un citiem ar to saistītajiem noteikumiem.
Niniejszym TRCZ s.r.o. oświadcza, że B94UM jest zgodny z zasadniczymi wymogami oraz pozostałymi stosownymi postanowieniami Dyrektywy 1999/5/EC.
Hér með lýsir TRCZ s.r.o. yfir því að B94UM er í samræmi við grunnkröfur og aðrar kröfur, sem gerðar eru í tilskipun 1999/5/EC.
TRCZ s.r.o. erklærer herved at utstyret B94UM er i samsvar med de grunnleggende krav og øvrige relevante krav i direktiv 1999/5/EF.
С настоящето, TRCZ s.r.o., декларира, че B94UM е в съответствие със съществените изисквания и другите приложими разпоредби на Директива 1999/5/EC.
Prin prezenta, TRCZ s.r.o., declară că aparatul B94UM este în conformitate cu cerințele esențiale și cu alte prevederi pertinente ale Directivei 1999/5/CE.
Ovim, TRCZ s.r.o., izjavljuje da ovaj B94UM je usklađen sa bitnim zahtjevima i drugim relevantnim odredbama Direktive 1999/5/EC.
Непермјет кесј, TRCZ s.r.o., декларој ќе кy B94UM еште не пјатим ме керкесат телбесоре дхе диспозитат е тјера перкатесе те Директјес 1999/5/EC.
Ovim TRCZ s.r.o., izjavljuje da je B94UM u skladu sa bitnim zahtjevima i drugim relevantnim odredbama Direktive 1999/5/EC i Pravilnika o RiTT opremi (NN 25/2012).
Ovim, TRCZ s.r.o., deklarirše da je B94UM u skladu sa osnovnim zahtevima i ostalim relevantnim odredbama Direktive 1999/5/EC.
İşbu belge ile TRCZ s.r.o., bu B94UM ürününün 1999/5/EC Yönetmeliği'nin temel gerekliliklerine ve diğer ilgili hükümlerine uygun olduğunu beyan eder.
The DECLARATION of CONFORMITY (DoC) is available at the following address: <a href="http://www.tokai-rika.co.jp/pc">http://www.tokai-rika.co.jp/pc</a>



PharmaSOS.com

<p>Hereby, TOYOTA MOTOR CORPORATION, declares that this TMLF10-51 is in compliance with the essential requirements and other relevant provisions of Directive 1999/5/EC.</p>
<p>TOYOTA MOTOR CORPORATION vakuuttaa täten että TMLF10-51 tyyppinen laite on direktiivin 1999/5/EY oleellisten vaatimusten ja sitä koskevien direktiivin muiden ehtojen mukainen.</p>
<p>Hierbij verklaart TOYOTA MOTOR CORPORATION dat het toestel TMLF10-51 in overeenstemming is met de essentiële eisen en de andere relevante bepalingen van richtlijn 1999/5/EG.</p>
<p>Par la présente TOYOTA MOTOR CORPORATION déclare que l'appareil TMLF10-51 est conforme aux exigences essentielles et aux autres dispositions pertinentes de la directive 1999/5/CE.</p>
<p>Härmed intygar TOYOTA MOTOR CORPORATION att denna TMLF10-51 står i överensstämmelse med de väsentliga egenskapskrav och övriga relevanta bestämmelser som framgår av direktiv 1999/5/EG.</p>
<p>Undertegnede TOYOTA MOTOR CORPORATION erklærer herved, at følgende udstyr TMLF10-51 overholder de væsentlige krav og øvrige relevante krav i direktiv 1999/5/EF.</p>
<p>Hiermit erkläre TOYOTA MOTOR CORPORATION, dass sich das Gerät TMLF10-51 in Übereinstimmung mit den grundlegenden Anforderungen und den übrigen einschlägigen Bestimmungen der Richtlinie 1999/5/EG befindet.</p>
<p>ΜΕ ΤΗΝ ΠΑΡΟΥΣΑ ΤΟΥΤΑ ΜΟΤΟΡ ΚΟΡΠΟΡΑΤΙΟΝ ΔΗΛΩΝΕΙ ΟΤΙ ΤΜΛΦ10-51 ΣΥΜΜΟΡΦΩΝΕΤΑΙ ΠΡΟΣ ΤΙΣ ΟΥΣΙΩΔΕΙΣ ΑΠΑΙΤΗΣΕΙΣ ΚΑΙ ΤΙΣ ΛΟΙΠΕΣ ΣΧΕΤΙΚΕΣ ΔΙΑΤΑΞΕΙΣ ΤΗΣ ΟΔΗΓΙΑΣ 1999/5/ΕΚ.</p>
<p>Con la presente TOYOTA MOTOR CORPORATION dichiara che questo TMLF10-51 è conforme ai requisiti essenziali ed alle altre disposizioni pertinenti stabilite dalla direttiva 1999/5/CE.</p>
<p>Por medio de la presente TOYOTA MOTOR CORPORATION declara que el TMLF10-51 cumple con los requisitos esenciales y cualesquiera otras disposiciones aplicables o exigibles de la Directiva 1999/5/CE.</p>
<p>TOYOTA MOTOR CORPORATION declara que este TMLF10-51 está conforme com os requisitos essenciais e outras disposições da Directiva 1999/5/CE.</p>

Hawnhekk, TOYOTA MOTOR CORPORATION, jiddikjara li dan TMLF10-51 jikkonforma mal-ftigijiet essenzjali u ma provvedimenti oħrajn relevanti li hemm fid-Dirrettiva 1999/5/EC.
Käesolevaga kinnitab TOYOTA MOTOR CORPORATION seadme TMLF10-51 vastavust direktiivi 1999/5/EÜ põhiolemusele ja nimetatud direktiivist tulenevatele teistele asjakohastele sätetele.
Alulírott, TOYOTA MOTOR CORPORATION nyilatkozom, hogy a TMLF10-51 megfelel a vonatkozó alapvető követelményeknek és az 1999/5/EC irányelv egyéb előírásainak.
TOYOTA MOTOR CORPORATION týmto vyhlasuje, že TMLF10-51 spĺňa základné požiadavky a všetky príslušné ustanovenia Smernice 1999/5/ES.
TOYOTA MOTOR CORPORATION tímto prohlašuje, že tento TMLF10-51 je ve shodě se základními požadavky a dalšími příslušnými ustanoveními směrnice 1999/5/ES.
TOYOTA MOTOR CORPORATION izjavlja, da je ta TMLF10-51 v skladu z bistvenimi zahtevami in ostalimi relevantnimi določili direktive 1999/5/ES.
Šiuo TOYOTA MOTOR CORPORATION deklaruoja, kad šis TMLF10-51 atitinka esminius reikalavimus ir kitas 1999/5/EB Direktyvos nuostatas.
Ar šo TOYOTA MOTOR CORPORATION deklarē, ka TMLF10-51 atbilst Direktīvas 1999/5/EK būtiskajām prasībām un citiem ar to saistītajiem noteikumiem.
Niniejszym TOYOTA MOTOR CORPORATION oświadcza, że TMLF10-51 jest zgodny z zasadniczymi wymogami oraz pozostałymi stosownymi postanowieniami Dyrektywy 1999/5/EC.
Hér með lýsir TOYOTA MOTOR CORPORATION yfir því að TMLF10-51 er í samræmi við grunnkröfur og aðrar kröfur, sem gerðar eru í tilskipun 1999/5/EC.
TOYOTA MOTOR CORPORATION erklærer herved at utstyret TMLF10-51 er i samsvar med de grunnleggende krav og øvrige relevante krav i direktiv 1999/5/EF.
С настоящето, TOYOTA MOTOR CORPORATION, декларира, че TMLF10-51 е в съответствие със съществените изисквания и другите приложими разпоредби на Директива 1999/5/EC.

Prin prezenta, TOYOTA MOTOR CORPORATION, declară că aparatul TMLF10-51 este în conformitate cu cerințele esențiale și cu alte prevederi pertinente ale Directivei 1999/5/CE.

Ovim, TOYOTA MOTOR CORPORATION, izjavljuje da ovaj TMLF10-51 je usklađen sa bitnim zahtjevima i drugim relevantnim odredbama Direktive 1999/5/EC.

Nepermjet kesaj, TOYOTA MOTOR CORPORATION, deklaroi qe ky TMLF10-51 eshte ne pajtim me kerkesat thelbesore dhe dispozitat e tjera perkatese te Direktives 1999/5/EC.

Ovim TOYOTA MOTOR CORPORATION, izjavljuje da je TMLF10-51 u skladu s bitnim zahtjevima i drugim relevantnim odredbama Direktive 1999/5/EC i Pravilnika o RITT opremi (NN 25/2012).

Ovim, TOYOTA MOTOR CORPORATION, deklarirše da je TMLF10-51 u skladu sa osnovnim zahtevima i ostalim relevantnim odredbama Direktive 1999/5/EC.

İşbu belge ile TOYOTA MOTOR CORPORATION, bu TMLF10-51 ürününün 1999/5/EC Yönetmeliği'nin temel gerekliliklerine ve diğer ilgili hükümlerine uygun olduğunu beyan eder.

3

Operation of each component

**⚠ WARNING**

■ **Caution regarding interference with electronic devices**

- People with implantable cardiac pacemakers, cardiac resynchronization therapy-pacemakers or implantable cardioverter defibrillators should maintain a reasonable distance between themselves and the smart entry & start system antennas. (→P. 138)  
The radio waves may affect the operation of such devices. If necessary, the entry function can be disabled. Ask any authorized Toyota dealer or repairer, or another duly qualified and equipped professional for details, such as the frequency of radio waves and timing of the emitted radio waves. Then, consult your doctor to see if you should disable the entry function.
- User of any electrical medical device other than implantable cardiac pacemakers, cardiac resynchronization therapy-pacemakers or implantable cardioverter defibrillators should consult the manufacturer of the device for information about its operation under the influence of radio waves.  
Radio waves could have unexpected effects on the operation of such medical devices.

Ask any authorized Toyota dealer or repairer, or another duly qualified and equipped professional for details for disabling the entry function.

# TOYOTA

## TOYOTA MOTOR CORPORATION

1, TOYOTA-CHO, TOYOTA, AICHI, 471-8571, JAPAN TEL: +81-565-28-2121

### R&TTE Declaration of Conformity

We,

Manufacturer's Name: TOYOTA MOTOR CORPORATION  
Manufacturer's Address: 1, Toyota -cho, Toyota, Aichi, 471-8572, Japan

hereby declare under our sole responsibility that the product:

Product Name: LF Oscillator  
Product Model: TMLF10-51

to which this declaration relates is in conformity with the essential requirements and other relevant requirements of the R&TTE Directive (1999/5/EC). The product is compliant with the following standards and/or other normative documents:

-Health & safety requirements: EN 60950-1  
-EMC requirements EN 301 489-01 & EN 301 489-03  
-Effective uses of radio spectrum: EN 300 330-2

Supplementary information:

* CE mark	
* Member states intended for use	EU and EFTA

Date: January 9, 2013

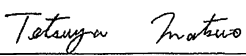
Signature:   
Tetsuya Matsuo

## Front seats

### Adjustment procedure

- ① Seat position adjustment lever
- ② Seatback angle adjustment lever
- ③ Vertical height adjustment lever (driver's seat only)

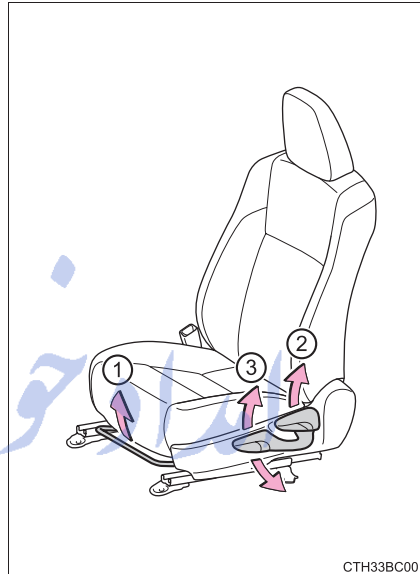

CTH33BC001

### ⚠ WARNING

#### ■ Seat adjustment

- Do not recline the seat more than necessary when the vehicle is in motion to reduce the risk of sliding under the lap belt. If the seat is too reclined, the lap belt may slide past the hips and apply restraint forces directly to the abdomen or your neck may contact the shoulder belt, increasing the risk of death or serious injury in the event of an accident.
- After adjusting the seat, make sure that the seat is locked in position.

#### ■ When adjusting the seat positions

- Make sure to leave enough space around the feet so they do not get stuck.

3

Operation of each component

## Rear seats

The seatbacks of the rear seats can be folded down.

### Folding down the rear seatbacks

- 1 Stow the rear outside seat belt buckles and stow the rear center seat belt buckle as shown.

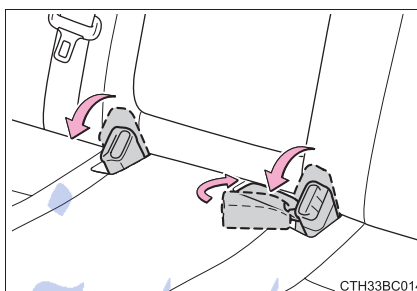

- 2 Pull the seatback lock release knob and fold the seatback down.

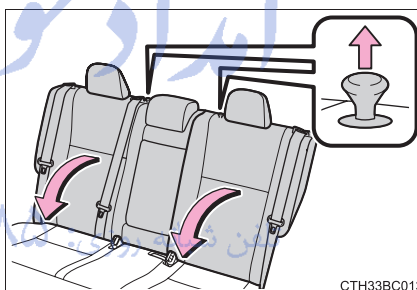

FarmaSOS.com



 WARNING**■ When folding the rear seatbacks down**

Observe the following precautions. Failure to do so may result in death or serious injury.

- Do not fold the seatbacks down while driving.
- Stop the vehicle on level ground, set the parking brake and shift the shift lever to P (Multidrive) or N (multi-mode manual transmission and manual transmission).
- Do not allow anyone to sit on a folded seatback or in the trunk while driving.
- Do not allow children to enter the trunk.
- Do not allow anyone to sit on the rear center seat if the rear right seat is folded down, as the seat belt buckle for the rear center seat belt is then concealed under the folded seat and cannot be used.
- Be careful not to catch your hand when folding the rear seatbacks.
- Adjust the position of the front seat before folding down the rear seatbacks so that the front seat does not interfere with the rear seatbacks when folding down the rear seatbacks.

تلفن شبانه روزی: ۰۲۱-۸۸۶۲۰۸۵

FarmaSOS.com

**⚠ WARNING**

■ **After returning the seatback to the upright position**

Observe the following precautions. Failure to do so may result in death or serious injury.

- Make sure that the seatback is securely locked in position by lightly rocking it back and forth.  
If the seatback is not securely locked, the red marking will be visible on the seatback lock release knob. Make sure that the red marking is not visible.

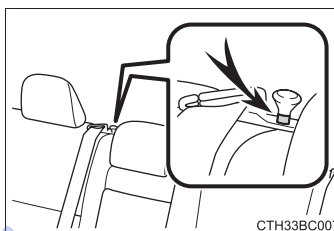

- Check that the seat belts are not twisted or caught under the seat.

**⚠ NOTICE**

■ **When the rear right seatback is folded down**

Make sure the luggage loaded in the enlarged trunk will not damage the webbing of the rear center seat belt.

تلفن شبانه روزی: ۰۲۱-۸۸۶۲۰۸۵

FarmaSOS.com

## Head restraints

Head restraints are provided for all seats.

### Vertical adjustment

- ① Up  
Pull the head restraints up.
- ② Down  
Push the head restraint down while pressing the lock release button.

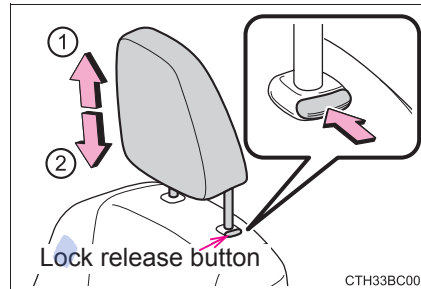

### Removing the head restraints

Pull the head restraint up while pressing the lock release button.

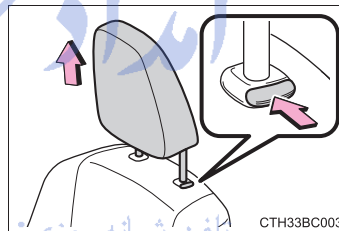

### Adjusting the height of the head restraints

Make sure that the head restraints are adjusted so that the center of the head restraint is closest to the top of your ears.

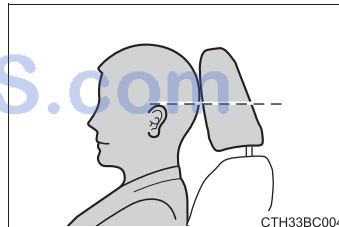

### Adjusting the rear center seat head restraint

Always raise the head restraint one level from the stowed position when using.

 WARNING

■ **Head restraint precautions**

Observe the following precautions regarding the head restraints. Failure to do so may result in death or serious injury.

- Use the head restraints designed for each respective seat.
- Adjust the head restraints to the correct position at all times.
- After adjusting the head restraints, push down on them and make sure they are locked in position.
- Do not drive with the head restraints removed.

امداد خودرو فارما

تلفن شبانه روزی: ۰۲۱-۸۸۸۶۲۰۸۵

FarmaSOS.com

## Steering wheel

### Adjustment procedure

- 1 Hold the steering wheel and push the lever down.

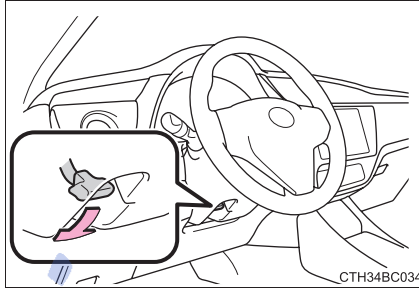

- 2 Adjust to the ideal position by moving the steering wheel horizontally and vertically. After adjustment, pull the lever up to secure the steering wheel.

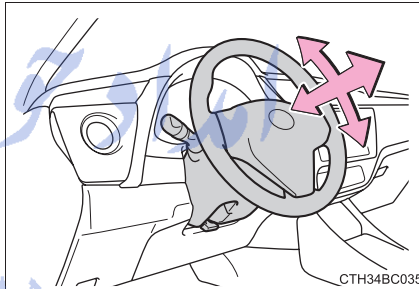

### Horn

To sound the horn, press on or close to the  mark.

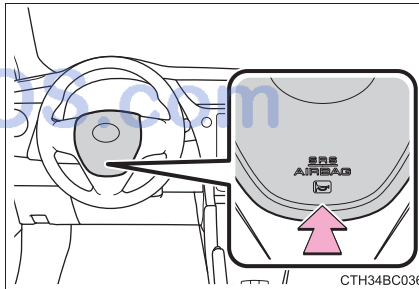

3

Operation of each component

 WARNING

■ **Caution while driving**

Do not adjust the steering wheel while driving. Doing so may cause the driver to mishandle the vehicle and cause an accident, resulting in death or serious injury.

■ **After adjusting the steering wheel**

Make sure that the steering wheel is securely locked. Otherwise, the steering wheel may move suddenly, possibly causing an accident, and resulting in death or serious injury. Also, the horn may not sound if the steering wheel is not securely locked.

امداد خودرو فارما

تلفن شبانه روزی: ۰۲۱-۸۸۸۶۲۰۸۵

FarmaSOS.com

## Inside rear view mirror

The rear view mirror's position can be adjusted to enable sufficient confirmation of the rear view.

### Adjusting the height of rear view mirror (auto anti-glare inside rear view mirror only)

The height of the rear view mirror can be adjusted to suit your driving posture.

Adjust the height of the rear view mirror by moving it up and down.

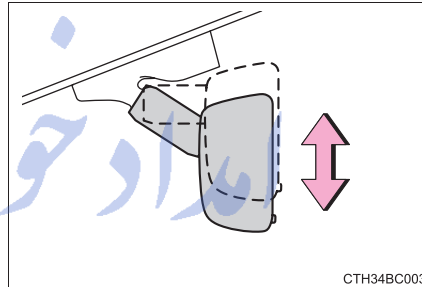

### Anti-glare function

- ▶ Manual anti-glare inside rear view mirror

Reflected light from the headlights of vehicles behind can be reduced by operating the lever.

- ① Normal position
- ② Anti-glare position

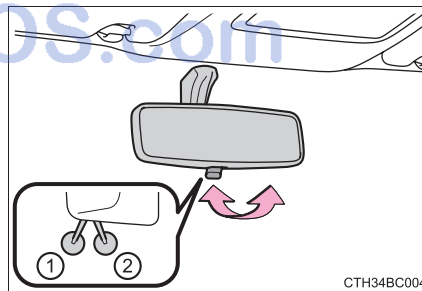

3

Operation of each component

► Auto anti-glare inside rear view mirror

Responding to the level of brightness of the headlights of vehicles behind, the reflected light is automatically reduced.

Changing automatic anti-glare function mode

On/off

When the automatic anti-glare function is in ON mode, the indicator illuminates.

Vehicles without a smart entry & start system: The function will set to ON mode each time the engine switch is turned to the "ON" position.

Pressing the button turns the function to OFF mode. (The indicator also turns off.)

Vehicles with a smart entry & start system: The function will set to ON mode each time the engine switch is turned to IGNITION ON mode.

Pressing the button turns the function to OFF mode. (The indicator also turns off.)

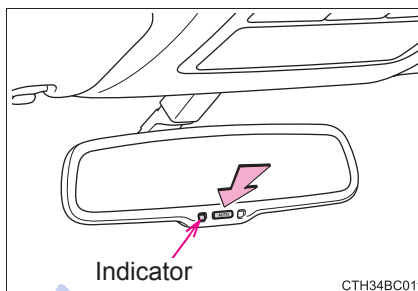

■ To prevent sensor error (vehicles with an auto anti-glare inside rear view mirror)

To ensure that the sensors operate properly, do not touch or cover them.

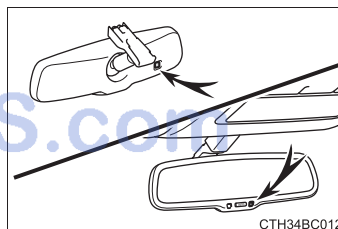



**⚠ WARNING**

Do not adjust the position of the mirror while driving.  
Doing so may lead to mishandling of the vehicle and cause an accident,  
resulting in death or serious injury.

امداد خودرو فارما

تلفن شبانه روزی: ۰۲۱-۸۸۸۶۲۰۸۵

FarmaSOS.com

## Outside rear view mirrors

### Adjustment procedure

1 To select a mirror to adjust, press the switch.

- ① Left
- ② Right

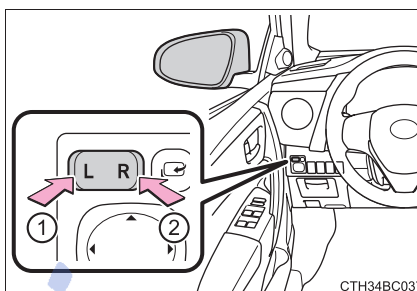

2 To adjust the mirror, press the switch.

- ① Up
- ② Right
- ③ Down
- ④ Left

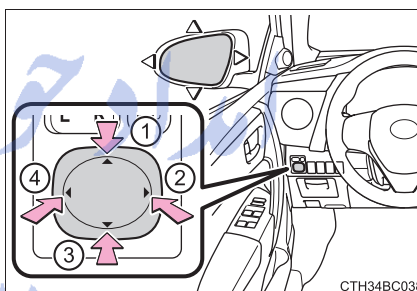

### Folding the mirrors

► Manual type

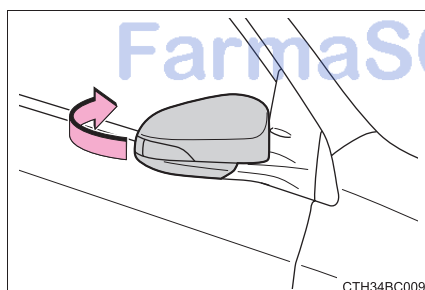

Push the mirror back in the direction of the vehicle's rear.

► Power type

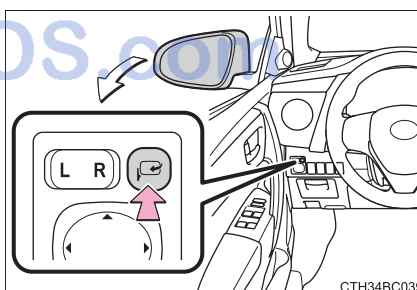

Press the switch to fold the mirrors.

Press it again to extend them to the original position.

**Automatically folding and extending the mirrors (if equipped)**

Automatic mode allows the folding or extending of the mirrors to be linked to locking/unlocking of the doors.

Automatic operation can be disabled by performing the following.

Turn the engine switch to off.

Press and hold the switch that folds the mirrors and ▲ of the mirror angle adjustment switch at the same time for more than 2 seconds.

Performing the above procedures again will reactivate automatic operation.

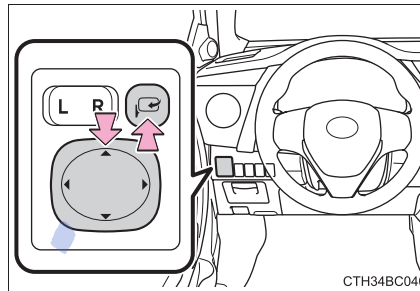
**■ Mirror angle can be adjusted when**

- ▶ Vehicles without a smart entry & start system

The engine switch is in the “ACC” or “ON” position.

- ▶ Vehicles with a smart entry & start system

The engine switch is in ACCESSORY or IGNITION ON mode.

**■ When disconnecting and reconnecting battery terminals (vehicles with an automatic folding and extending mirror function)**

The automatic folding and extending mirror function will return to on as default. To turn the function off, press the switch again to select off.

**■ When the mirrors are fogged up (if equipped)**

The outside rear view mirrors can be cleared using the mirror defoggers. Turn on the rear window defogger to turn on the outside rear view mirror defoggers. (→P. 394, 403)

 WARNING

■ **Important points while driving**

Observe the following precautions while driving.  
Failure to do so may result in loss of control of the vehicle and cause an accident, resulting in death or serious injury.

- Do not adjust the mirrors while driving.
- Do not drive with the mirrors folded.
- Both the driver and passenger side mirrors must be extended and properly adjusted before driving.

■ **When a mirror is moving**

To avoid personal injury and mirror malfunction, be careful not to get your hand caught by the moving mirror.

■ **When the mirror defoggers are operating (if equipped)**

Do not touch the rear view mirror surfaces, as they can become very hot and burn you.

امداد خودرو فارما  
تلفن شبانه روزی: ۰۲۱-۸۸۸۶۲۰۸۵

FarmaSOS.com

## Power windows\*

### Opening and closing procedures

The power windows can be opened and closed using the switches. Operating the switch moves the windows as follows:

#### ► One-touch opening/closing on driver's window only type

- ① Closing
- ② One-touch closing (driver's window only)\*
- ③ Opening
- ④ One-touch opening (driver's window only)\*

\*: To stop the window partway, operate the switch in the opposite direction.

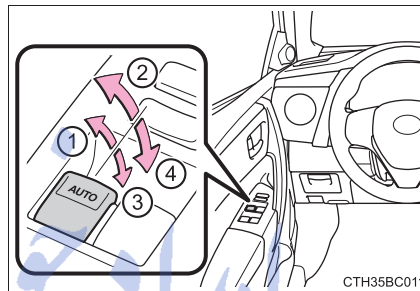

#### ► One-touch opening/closing on all windows type

- ① Closing
- ② One-touch closing\*
- ③ Opening
- ④ One-touch opening\*

\*: To stop the window partway, operate the switch in the opposite direction.

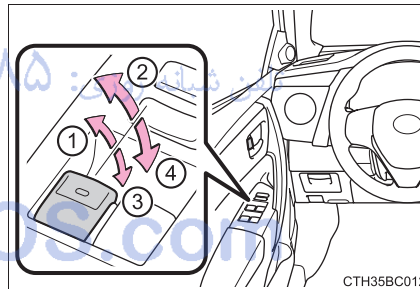

### Window lock switch

Press the switch to lock the passenger window switches.

Use this switch to prevent children from accidentally opening or closing a passenger window.

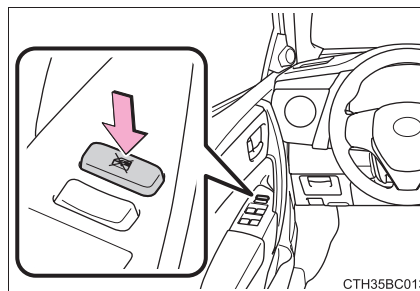

\*: If equipped

■ **The power windows can be operated when**

- ▶ Vehicles without a smart entry & start system

The engine switch is in the "ON" position.

- ▶ Vehicles with a smart entry & start system

The engine switch is in IGNITION ON mode.

■ **Operating the power windows after turning the engine off**

- ▶ Vehicles without a smart entry & start system

The power windows can be operated for approximately 45 seconds even after the engine switch is turned to the "ACC" or "LOCK" position. They cannot, however, be operated once either front door is opened.

- ▶ Vehicles with a smart entry & start system

The power windows can be operated for approximately 45 seconds even after the engine switch is turned to ACCESSORY mode or turned off. They cannot, however, be operated once either front door is opened.

■ **Jam protection function (windows with one-touch closing function only)**

If an object becomes jammed between the window and the window frame while the window is closing, window movement is stopped and the window is opened slightly.

تلفن شبانه روزی: ۰۲۱-۸۸۸۶۲۰۸۵

FarmaSOS.com

**■ When the power window does not close normally (windows with one-touch closing function only)**

If the jam protection function is operating abnormally and a window cannot be closed, perform the following operations using the power window switch on the relevant door.

- Vehicles without a smart entry & start system: After stopping the vehicle, the window can be closed by holding the power window switch in the one-touch closing position while the engine switch is turned to the "ON" position.

Vehicles with a smart entry & start system: After stopping the vehicle, the window can be closed by holding the power window switch in the one-touch closing position while the engine switch is turned to IGNITION ON mode.

- If the window still cannot be closed even by carrying out the operation as explained above, initialize the function by performing the following procedure.

- 1 Hold the power window switch in the one-touch closing position. Continue holding the switch for a further 6 seconds after the window has closed.
- 2 Hold the power window switch in the one-touch opening position. Continue holding the switch for a further 2 seconds after the window has opened completely.
- 3 Hold the power window switch in the one-touch closing position once again. Continue holding the switch for a further 2 seconds after the window has closed.

If you release the switch while the window is moving, start again from the beginning.

If the window continues to close but then re-open slightly even after performing the above procedure correctly, have the vehicle inspected by any authorized Toyota dealer or repairer, or another duly qualified and equipped professional.

FarmaSOS.com

**⚠ WARNING**

Observe the following precautions.  
Failure to do so may result in death or serious injury.

**■ Closing the windows**

- The driver is responsible for all the power window operations, including the operation for the passengers. In order to prevent accidental operation, especially by a child, do not let a child operate the power windows. It is possible for children and other passengers to have body parts caught in the power window. Also, when riding with a child, it is recommended to use the window lock switch.(→P. 169)
- Check to make sure that all passengers do not have any part of their body in a position where it could be caught when a window is being operated.
- When exiting the vehicle, turn the engine switch off, carry the key and exit the vehicle along with the child. There may be accidental operation, due to mischief, etc., that may possibly lead to an accident.

**■ Jam protection function (windows with one-touch closing function only)**

- Never use any part of your body to intentionally activate the jam protection function.
- The jam protection function may not work if something gets jammed just before the window is fully closed. Be careful not to get any part of your body jammed in the window.

FarmaSOS.com



## Driving

## 4

<b>4-1. Before driving</b>	<b>4-5. Toyota Safety Sense</b>
Driving the vehicle ..... 174	Toyota Safety Sense ..... 240
Cargo and luggage ..... 187	PCS (Pre-Crash Safety system) ..... 246
Trailer towing ..... 188	LDA (Lane Departure Alert) ..... 259
<b>4-2. Driving procedures</b>	Automatic High Beam ..... 264
Engine (ignition) switch (vehicles without a smart entry & start system) ..... 196	RSA (Road Sign Assist) ..... 268
Engine (ignition) switch (vehicles with a smart entry & start system) ..... 199	<b>4-6. Using the driving support systems</b>
Multidrive ..... 209	Stop & Start system ..... 274
Multi-mode Manual Transmission ..... 213	Cruise control ..... 286
Manual transmission ..... 218	Speed limiter ..... 290
Turn signal lever ..... 222	Toyota parking assist-sensor ..... 293
Parking brake ..... 223	Simple-IPA (Simple-Intelligent Parking Assist) ..... 299
<b>4-3. Operating the lights and wipers</b>	Diesel particulate filter system ..... 313
Headlight switch ..... 224	Driving assist systems ..... 314
Fog light switch ..... 230	Hill-start assist control ..... 321
Windshield wipers and washer ..... 232	<b>4-7. Driving tips</b>
<b>4-4. Refueling</b>	Winter driving tips ..... 323
Opening the fuel tank cap ..... 237	

## Driving the vehicle

The following procedures should be observed to ensure safe driving:

### Starting the engine

→P. 196, 199

### Driving

#### ▶ Multidrive

- 1 With the brake pedal depressed, shift the shift lever to D.  
(→P. 209)
- 2 Release the parking brake. (→P. 223)
- 3 Gradually release the brake pedal and gently depress the accelerator pedal to accelerate the vehicle.

#### ▶ Multi-mode manual transmission

- 1 With the brake pedal depressed, shift the shift lever to E or M.  
(→P. 213)  
When shifting the shift lever to E: Make sure that the display of the gear position indicator shows E.  
When shifting the shift lever to M: Make sure that the display of the gear position indicator shows 1.
- 2 Release the parking brake. (→P. 223)
- 3 Gradually release the brake pedal and gently depress the accelerator pedal to accelerate the vehicle.

#### ▶ Manual transmission

- 1 While depressing the clutch pedal, shift the shift lever to 1.  
(→P. 218)
- 2 Release the parking brake. (→P. 223)
- 3 Gradually release the clutch pedal. At the same time, gently depress the accelerator pedal to accelerate the vehicle.

### Stopping

#### ► Multidrive

- 1 With the shift lever in D, depress the brake pedal.
- 2 If necessary, set the parking brake.

If the vehicle is to be stopped for an extended period of time, shift the shift lever to P or N. (→P. 209)

#### ► Multi-mode manual transmission

- 1 With the shift lever in E or M, depress the brake pedal.
- 2 If necessary, set the parking brake.

If the vehicle is to be stopped for an extended period of time, shift the shift lever to N. (→P. 213)

#### ► Manual transmission

- 1 While depressing the clutch pedal, depress the brake pedal.
- 2 If necessary, set the parking brake.

If the vehicle is to be stopped for an extended period of time, shift the shift lever to N. (→P. 218)

Vehicles with a Stop & Start system: If the Stop & Start system is enabled, shifting the shift lever to N and releasing the clutch pedal will stop the engine. (→P. 274)

### Parking the vehicle

#### ► Multidrive

- 1 With the shift lever in D, depress the brake pedal.
- 2 Shift the shift lever to P. (→P. 209)
- 3 Set the parking brake. (→P. 223)
- 4 Vehicles without a smart entry & start system: Turn the engine switch to the "LOCK" position to stop the engine.  
Vehicles with a smart entry & start system: Press the engine switch to stop the engine.
- 5 Lock the door, making sure that you have the key on your person.  
If parking on a hill, block the wheels as needed.

► Multi-mode manual transmission

- 1 With the shift lever in E or M, depress the brake pedal.
- 2 Shift the shift lever to E, M or R. (→P. 213)
- 3 Set the parking brake. (→P. 223)
- 4 Vehicles without a smart entry & start system: Turn the engine switch to the "LOCK" position to stop the engine.

Vehicles with a smart entry & start system: Press the engine switch to stop the engine.

When shifting the shift lever to E or M: Make sure that the display of the gear position indicator shows 1.

When shifting the shift lever to R: Make sure that the display of the gear position indicator shows R.

- 5 Lock the door, making sure that you have the key on your person.

If parking on a hill, if necessary, block the wheels.

► Manual transmission

- 1 While depressing the clutch pedal, depress the brake pedal.
- 2 Shift the shift lever to N. (→P. 218)

If parking on a hill, shift the shift lever to 1 or R.

- 3 Set the parking brake. (→P. 223)
- 4 Vehicles without a smart entry & start system: Turn the engine switch to the "LOCK" position to stop the engine.

Vehicles with a smart entry & start system: Press the engine switch to stop the engine.

- 5 Lock the door, making sure that you have the key on your person.

If parking on a hill, if necessary, block the wheels.

**Starting off on a steep uphill**

## ▶ Multidrive

- 1 Make sure that the parking brake is set and shift the shift lever to D.
- 2 Gently depress the accelerator pedal.
- 3 Release the parking brake.

## ▶ Multi-mode manual transmission

- 1 With the brake pedal depressed, firmly set the parking brake and shift the shift lever to E or M.

When shifting the shift lever to E: Make sure that the display of the gear position indicator shows E.

When shifting the shift lever to M: Make sure that the display of the gear position indicator shows 1.

- 2 Gently depress the accelerator pedal.
- 3 Release the parking brake.

## ▶ Manual transmission

- 1 With the parking brake firmly set and the clutch pedal fully depressed, shift the shift lever to 1.
- 2 Lightly depress the accelerator pedal at the same time as gradually releasing the clutch pedal.
- 3 Release the parking brake.

**■ When starting off on an uphill**

The hill-start assist control is available. (→P. 314, 321)

**■ Driving in the rain**

- Drive carefully when it is raining, because visibility will be reduced, the windows may become fogged-up, and the road will be slippery.
- Drive carefully when it starts to rain, because the road surface will be especially slippery.
- Refrain from high speeds when driving on an expressway in the rain, because there may be a layer of water between the tires and the road surface, preventing the steering and brakes from operating properly.

**■ Engine speed while driving (vehicles with a Multidrive)**

In the following conditions, the engine speed may become high while driving. This is due to automatic up-shifting control or down-shifting implementation to meet driving conditions. It does not indicate sudden acceleration.

- The vehicle is judged to be driving uphill or downhill
- When the accelerator pedal is released
- When the brake pedal is depressed while sport mode is selected

**■ Breaking in your new Toyota**

To extend the life of the vehicle, observing the following precautions is recommended:

- For the first 300 km (186 miles):  
Avoid sudden stops.
- For the first 800 km (500 miles):  
Do not tow a trailer.
- For the first 1000 km (621 miles):
  - Do not drive at extremely high speeds.
  - Avoid sudden acceleration.
  - Do not drive continuously in low gears.
  - Do not drive at a constant speed for extended periods.

### ■ Idling time before engine stop (diesel engine)

To prevent damage to the turbocharger, allow the engine to idle immediately after high-speed driving or hill climbing.

Driving condition		Idling time
Normal city driving		Not necessary
High-speed driving	Constant speed of approx. 80 km/h (50 mph)	Approximately 20 seconds
	Constant speed of approx. 100 km/h (63 mph)	Approximately 1 minute
Steep hill driving or continuous driving at 100 km/h (63 mph) or more (race track driving etc.)		Approximately 2 minutes

### ■ Operating your vehicle in a foreign country

Comply with the relevant vehicle registration laws and confirm the availability of the correct fuel. (→P. 597)

#### WARNING

Observe the following precautions.  
Failure to do so may result in death or serious injury.

#### ■ When starting the vehicle (except vehicles with a manual transmission)

Vehicles with a Multidrive: Always keep your foot on the brake pedal while stopped with the engine running. This prevents the vehicle from creeping.

Vehicles with a multi-mode manual transmission: Always keep your foot on the brake pedal while stopped with the engine running. This prevents the vehicle from moving unexpectedly.

 **WARNING**

Observe the following precautions.  
Failure to do so may result in death or serious injury.

**■ When driving the vehicle**

- Do not drive if you are unfamiliar with the location of the brake and accelerator pedals to avoid depressing the wrong pedal.
  - Accidentally depressing the accelerator pedal instead of the brake pedal will result in sudden acceleration that may lead to an accident.
  - When backing up, you may twist your body around, leading to a difficulty in operating the pedals. Make sure to operate the pedals properly.
  - Make sure to keep a correct driving posture even when moving the vehicle only slightly. This allows you to depress the brake and accelerator pedals properly.
  - Depress the brake pedal using your right foot. Depressing the brake pedal using your left foot may delay response in an emergency, resulting in an accident.
- Do not drive the vehicle over or stop the vehicle near flammable materials. The exhaust system and exhaust gases can be extremely hot. These hot parts may cause a fire if there is any flammable material nearby.
- During normal driving, do not turn off the engine. Turning the engine off while driving will not cause loss of steering or braking control, but the power assist to these systems will be lost. This will make it more difficult to steer and brake, so you should pull over and stop the vehicle as soon as it is safe to do so. تلفن شیشه روزی: ۰۸۵-۸۸۸۶۰۸۸۸  
However, in the event of an emergency, such as if it becomes impossible to stop the vehicle in the normal way: →P. 503
- Use engine braking (downshift) to maintain a safe speed when driving down a steep hill.  
Using the brakes continuously may cause the brakes to overheat and lose effectiveness. (→P. 209, 213, 218)
- Do not adjust the display, the positions of the steering wheel, the seat, or the inside or outside rear view mirrors while driving.  
Doing so may result in a loss of vehicle control.
- Always check that all passengers' arms, heads or other parts of their body are not outside the vehicle.



 **WARNING**

Observe the following precautions.  
Failure to do so may result in death or serious injury.

**■ When driving on slippery road surfaces**

- Sudden braking, acceleration and steering may cause tire slippage and reduce your ability to control the vehicle.
- Sudden acceleration, engine braking due to shifting, or changes in engine speed could cause the vehicle to skid.
- After driving through a puddle, lightly depress the brake pedal to make sure that the brakes are functioning properly. Wet brake pads may prevent the brakes from functioning properly. If the brakes on only one side are wet and not functioning properly, steering control may be affected.

**■ When shifting the shift lever**

- Except vehicles with a manual transmission: Do not let the vehicle roll backward while the shift lever is in a driving position, or roll forward while the shift lever is in R.  
Doing so may cause the engine to stall or lead to poor brake and steering performance, resulting in an accident or damage to the vehicle.
- Vehicles with a Multidrive: Do not shift the shift lever to P while the vehicle is moving.  
Doing so can damage the transmission and may result in a loss of vehicle control.
- Do not shift the shift lever to R while the vehicle is moving forward.  
Doing so can damage the transmission and may result in a loss of vehicle control.
- Do not shift the shift lever to a driving position while the vehicle is moving backward.  
Doing so can damage the transmission and may result in a loss of vehicle control.
- Moving the shift lever to N while the vehicle is moving will disengage the engine from the transmission. Engine braking is not available when N is selected.
- Except vehicles with a manual transmission: Be careful not to shift the shift lever with the accelerator pedal depressed. Shifting the shift lever to a gear other than P (Multidrive) or N may lead to unexpected rapid acceleration of the vehicle that may cause an accident and result in death or serious injury.

**⚠ WARNING**

Observe the following precautions.  
Failure to do so may result in death or serious injury.

**■ If you hear a squealing or scraping noise (brake pad wear indicators)**

Have the brake pads checked and replaced by any authorized Toyota dealer or repairer, or another duly qualified and equipped professional as soon as possible.

Rotor damage may result if the pads are not replaced when needed.

It is dangerous to drive the vehicle when the wear limits of the brake pads and/or those of the brake discs are exceeded.

**■ When the vehicle is stopped**

- Do not race the engine.  
If the vehicle is in any gear other than P (Multidrive) or N, the vehicle may accelerate suddenly and unexpectedly, causing an accident.
- Except vehicles with a manual transmission: In order to prevent accidents due to the vehicle rolling away, always keep depressing the brake pedal while the engine is running, and apply the parking brake as necessary.
- If the vehicle is stopped on an incline, in order to prevent accidents caused by the vehicle rolling forward or backward, always depress the brake pedal and securely apply the parking brake as needed.
- Avoid revving or racing the engine.  
Running the engine at high speed while the vehicle is stopped may cause the exhaust system to overheat, which could result in a fire if combustible material is nearby.

**■ When the vehicle is parked**

- Do not leave glasses, cigarette lighters, spray cans, or soft drink cans in the vehicle when it is in the sun.  
Doing so may result in the following:
  - Gas may leak from a cigarette lighter or spray can, and may lead to a fire.
  - The temperature inside the vehicle may cause the plastic lenses and plastic material of glasses to deform or crack.
  - Soft drink cans may fracture, causing the contents to spray over the interior of the vehicle, and may also cause a short circuit in the vehicle's electrical components.

 **WARNING**

Observe the following precautions.  
Failure to do so may result in death or serious injury.

■ **When the vehicle is parked**

- Do not leave cigarette lighters in the vehicle. If a cigarette lighter is in a place such as the glove box or on the floor, it may be lit accidentally when luggage is loaded or the seat is adjusted, causing a fire.
- Do not attach adhesive discs to the windshield or windows. Do not place containers such as air fresheners on the instrument panel or dashboard. Adhesive discs or containers may act as lenses, causing a fire in the vehicle.
- Do not leave a door or window open if the curved glass is coated with a metallized film such as a silver-colored one. Reflected sunlight may cause the glass to act as a lens, causing a fire.
- Vehicles with a Multidrive: Always apply the parking brake, shift the shift lever to P, stop the engine and lock the vehicle.  
Do not leave the vehicle unattended while the engine is running.  
Vehicles with a multi-mode manual transmission: Always apply the parking brake, shift the shift lever to E, M or R, stop the engine and lock the vehicle.  
Do not leave the vehicle unattended while the engine is running.
- Vehicles with a manual transmission: Always apply the parking brake, stop the engine and lock the vehicle.  
Do not leave the vehicle unattended while the engine is running.
- Do not touch the exhaust pipes while the engine is running or immediately after turning the engine off.  
Doing so may cause burns.
- Vehicles with a multi-mode manual transmission: Do not turn off the engine until 1st or reverse is engaged properly and completely. Confirm that the gear is engaged by viewing the gear position indicator.  
Parking the vehicle without a gear engaged may cause the vehicle to move result in an accident.

■ **When taking a nap in the vehicle**

Always turn the engine off. Otherwise, if you accidentally move the shift lever or depress the accelerator pedal, this could cause an accident or fire due to engine overheating. Additionally, if the vehicle is parked in a poorly ventilated area, exhaust gases may collect and enter the vehicle, leading to death or a serious health hazard.

 WARNING

Observe the following precautions.  
Failure to do so may result in death or serious injury.

■ **When braking**

- When the brakes are wet, drive more cautiously.  
Braking distance increases when the brakes are wet, and this may cause one side of the vehicle to brake differently than the other side. Also, the parking brake may not securely hold the vehicle.
- If the power brake assist function does not operate, do not follow other vehicles closely and avoid hills or sharp turns that require braking.  
In this case, braking is still possible, but the brake pedal should be depressed more firmly than usual. Also, the braking distance will increase. Have your brakes fixed immediately.
- Do not pump the brake pedal if the engine stalls.  
Each push on the brake pedal uses up the reserve for the power-assisted brakes.
- The brake system consists of 2 individual hydraulic systems; if one of the systems fails, the other will still operate. In this case, the brake pedal should be depressed more firmly than usual and the braking distance will increase.  
Have your brakes fixed immediately.

 NOTICE■ **When driving the vehicle (except vehicles with a manual transmission)**

- Do not depress the accelerator and brake pedals at the same time during driving, as this may restrain engine output.
- Vehicles with a Multidrive: Do not use the accelerator pedal or depress the accelerator and brake pedals at the same time to hold the vehicle on a hill.  
Vehicles with a multi-mode manual transmission: Do not use the accelerator pedal or starting assist system to hold the vehicle on a hill.  
Doing so may damage the clutch.



## NOTICE

■ **When driving the vehicle (vehicles with a manual transmission)**

- Do not depress the accelerator and brake pedals at the same time during driving, as this may restrain engine output.
- Do not shift gears unless the clutch pedal is fully depressed. After shifting, do not release the clutch pedal abruptly. Doing so may damage the clutch, transmission and gears.
- Observe the following to prevent the clutch from being damaged.
  - Do not rest your foot on the clutch pedal while driving. Doing so may cause clutch trouble.
  - Do not use any gear other than the 1st gear when starting off and moving forward. Doing so may damage the clutch.
  - Do not use the clutch to hold the vehicle when stopping on an uphill grade. Doing so may damage the clutch.
- Do not shift the shift lever to R when the vehicle is still moving. Doing so may damage the clutch, transmission and gears.

■ **When parking the vehicle (vehicles with a Multidrive)**

Always shift the shift lever to P. Failure to do so may cause the vehicle to move or the vehicle may accelerate suddenly if the accelerator pedal is accidentally depressed.

■ **Avoiding damage to vehicle parts**

- Do not turn the steering wheel fully in either direction and hold it there for an extended period of time. Doing so may damage the power steering motor.
- When driving over bumps in the road, drive as slowly as possible to avoid damaging the wheels, underside of the vehicle, etc.
- Diesel engine: Make sure to idle the engine immediately after high-speed driving or hill climbing. Stop the engine only after the turbocharger has cooled down. Failure to do so may cause damage to the turbocharger.

 NOTICE**■ If you get a flat tire while driving**

A flat or damaged tire may cause the following situations. Hold the steering wheel firmly and gradually depress the brake pedal to slow down the vehicle.

- It may be difficult to control your vehicle.
- The vehicle will make abnormal sounds or vibrations.
- The vehicle will lean abnormally.

Information on what to do in case of a flat tire (→P. 532, 555)

**■ When encountering flooded roads**

Do not drive on a road that has flooded after heavy rain etc. Doing so may cause the following serious damage to the vehicle:

- Engine stalling
- Short in electrical components
- Engine damage caused by water immersion

In the event that you drive on a flooded road and the vehicle is flooded, be sure to have any authorized Toyota dealer or repairer, or another duly qualified and equipped professional check the following:

- Brake function
- Changes in quantity and quality of engine oil, transaxle fluid, etc.
- Lubricant condition for the bearings and suspension joints (where possible), and the function of all joints, bearings, etc.

FarmaSOS.com

## Cargo and luggage

Take notice of the following information about storage precautions, cargo capacity and load:

### WARNING

#### ■ Things that must not be carried in the trunk

The following things may cause a fire if loaded in the trunk:

- Receptacles containing gasoline
- Aerosol cans

#### ■ Storage precautions

Observe the following precautions.

Failure to do so may prevent the pedals from being depressed properly, may block the driver's vision, or may result in items hitting the driver or passengers, possibly causing an accident.

- Stow cargo and luggage in the trunk whenever possible.
- To prevent cargo and luggage from sliding forward during braking, do not stack anything in the enlarged trunk. Keep cargo and luggage low, as close to the floor as possible.
- Do not place cargo or luggage in or on the following locations.
  - At the feet of the driver
  - On the front passenger or rear seats (when stacking items)
  - On the package tray
  - On the instrument panel
  - On the dashboard
  - Auxiliary box or tray that has no lid
- Secure all items in the occupant compartment.
- When you fold down the rear seats, long items should not be placed directly behind the front seats.
- Never allow anyone to ride in the enlarged trunk. It is not designed for passengers. They should ride in their seats with their seat belts properly fastened.

#### ■ Load and distribution

- Do not overload your vehicle.
- Do not apply loads unevenly.  
Improper loading may cause deterioration of steering or braking control which may cause death or serious injury.

## Trailer towing

Your vehicle is designed primarily as a passenger carrying vehicle. Towing a trailer will have an adverse effect on handling, performance, braking, durability, and fuel consumption. Your safety and satisfaction depend on the proper use of correct equipment and cautious driving habits. For your safety and the safety of others, do not overload the vehicle or trailer.

To tow a trailer safely, use extreme care and drive the vehicle in accordance with the trailer's characteristics and operating conditions.

Toyota warranties do not apply to damage or malfunction caused by towing a trailer for commercial purposes.

Ask your local authorized Toyota dealer or repairer or another duly qualified and equipped professional for further details before towing, as there are additional legal requirements in some countries.

### ◆ Weight limits

Check the allowable towing capacity, GVM (Gross Vehicle Mass), MPAC (Maximum Permissible Axle Capacity), and permissible drawbar load before towing. (→P. 592)

### ◆ Towing hitch/bracket

Toyota recommends the use of the Toyota hitch/bracket for your vehicle. Other products of a suitable nature and comparable quality may also be used.



### Important points regarding trailer loads

#### ■ Total trailer weight and permissible drawbar load

##### ① Total trailer weight

Weight of the trailer itself plus the trailer load should be within the maximum towing capacity. Exceeding this weight is dangerous. (→P. 592)

When towing a trailer, use a friction coupler or friction stabilizer (sway control device).

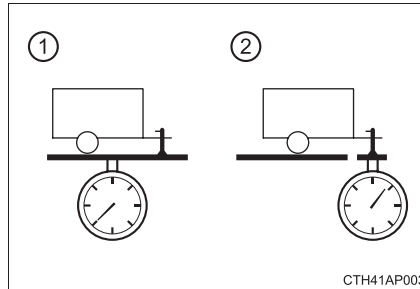

##### ② Permissible drawbar load

Allocate the trailer load so that the drawbar load is greater than 25 kg (55.1 lb.) or 4% of the towing capacity. Do not let the drawbar load exceed the indicated weight. (→P. 592)

تلفن شبانه روزی: ۰۲۱-۸۸۶۲۰۸۵

FarmaSOS.com

■ Information tag (manufacturer's label)

- ① Gross vehicle mass
- ② Maximum permissible rear axle capacity

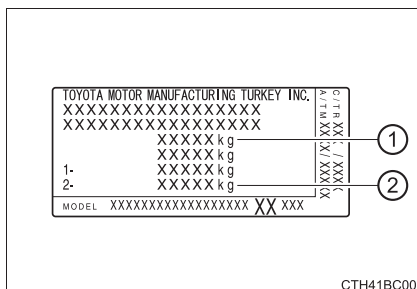

■ Gross vehicle mass

The combined weight of the driver, passengers, luggage, towing hitch, total curb mass and drawbar load should not exceed the gross vehicle mass by more than 100 kg (220.5 lb.). Exceeding this weight is dangerous.

■ Maximum permissible rear axle capacity

The weight borne by the rear axle should not exceed the maximum permissible rear axle capacity by 15% or more. Exceeding this weight is dangerous.

The values for towing capacity were derived from testing conducted at sea level. Take note that engine output and towing capacity will be reduced at high altitudes.

**⚠ WARNING**

■ **When the gross vehicle mass limit or maximum permissible axle capacity is exceeded**

Do not exceed the established speed limit for towing a trailer in built-up areas or 100 km/h (62 mph), whichever is lower.

Failing to observe this precaution may lead to an accident causing death or serious injury.

**Installation positions for the towing hitch/bracket and hitch ball**

- ① 461 mm (18.1 in.)
- ② 461 mm (18.1 in.)

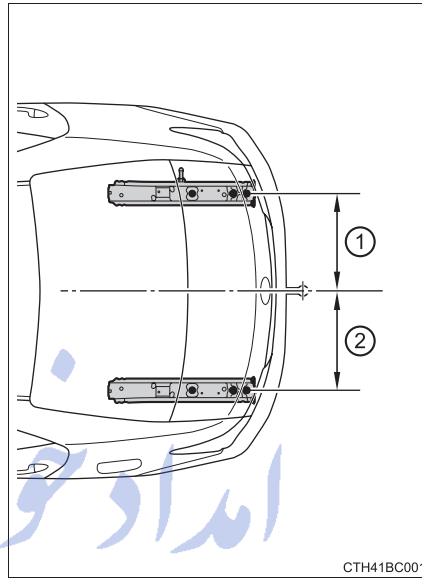

- ③ 1064 mm (41.9 in.)
- ④ 527 mm (20.7 in.)
- ⑤ 336 mm (13.2 in.)
- ⑥ 271 mm (10.7 in.)
- ⑦ 355 mm (14.0 in.)
- ⑧ 25 mm (1.0 in.)

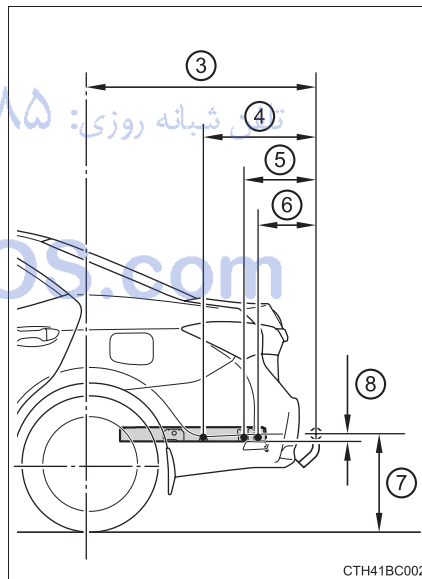

4

Driving

**■ Tire information**

- Increase the tire inflation pressure to 20.0 kPa (0.2 kgf/cm<sup>2</sup> or bar, 3 psi) greater than the recommended value when towing. (→P. 606)
- Increase the air pressure of the trailer tires in accordance with the total trailer weight and according to the values recommended by the manufacturer of your trailer.

**■ Trailer lights**

Check that the turn signal lights and stoplights are operating correctly every time you hitch up the trailer. Directly wiring up to your vehicle may damage the electrical system and stop the lights from functioning correctly.

**■ Break-in schedule**

Toyota recommends that vehicles fitted with new power train components should not be used for towing trailers for the first 800 km (500 miles).

**■ Safety checks before towing**

- Check that the maximum load limit for the towing hitch/bracket and hitch ball is not exceeded. Bear in mind that the coupling weight of the trailer will add to the load exerted on the vehicle. Also make sure that the total load exerted on the vehicle is within the range of the weight limits. (→P. 189)
- Ensure that the trailer load is secure.
- Supplementary outside rear view mirrors should be added to the vehicle if the traffic behind cannot be clearly seen with standard mirrors. Adjust the extending arms of these mirrors on both sides of the vehicle so that they always provide maximum visibility of the road behind.

**■ Maintenance**

- Maintenance must be performed more frequently when using the vehicle for towing due to the greater weight burden placed on the vehicle compared to normal driving.
- Retighten all bolts securing the hitching ball and bracket after towing for approximately 1000 km (600 miles).

 **NOTICE****■ When the rear bumper strengthening material is aluminum**

Ensure the steel bracket part does not come directly in contact with that area.

When steel and aluminum come into contact, there is a reaction similar to corrosion, which will weaken the section concerned and may result in damage. Apply a rust inhibitor to parts that will come in contact when attaching a steel bracket.

**Guidance**

Your vehicle will handle differently when towing a trailer. In order to avoid accident, death or serious injury, keep the following in mind when towing:

**■ Checking connections between trailer and lights**

Stop the vehicle and check the operation of the connection between the trailer and lights after driving for a brief period as well as before starting off.

**■ Practicing driving with a coupled trailer**

- Get the feel for turning, stopping and reversing with the trailer coupled by practicing in an area with no or light traffic.
- When reversing with a coupled trailer, hold the section of the steering wheel nearest to you and rotate clockwise to turn the trailer left or counterclockwise to turn it right. Always rotate a little at a time to prevent steering error. Have someone guide you when reversing to lessen the risk of an accident.

**■ Increasing vehicle-to-vehicle distance**

At a speed of 10 km/h (6 mph), the distance to the vehicle running ahead of you should be equivalent to or greater than the combined length of your vehicle and trailer. Avoid sudden braking that may cause skidding. Otherwise, the vehicle may spin out of control. This is especially true when driving on wet or slippery road surfaces.

**■ Sudden acceleration/steering input/cornering**

Executing sharp turns when towing may result in the trailer colliding with your vehicle. Decelerate well in advance when approaching turns and take them slowly and carefully to avoid sudden braking.

**■ Important points regarding turning**

The wheels of the trailer will travel closer to the inside of the curve than the wheels of the vehicle. To make allowance for this, take the turns wider than you would normally do.

**■ Important points regarding stability**

Vehicle movement resulting from uneven road surfaces and strong crosswinds will affect handling. The vehicle may also be rocked by passing buses or large trucks. Frequently check behind when moving alongside such vehicles. As soon as such vehicle movement occurs, immediately start to decelerate smoothly by slowly applying the brakes. Always steer the vehicle straight ahead while braking.

**■ Passing other vehicles**

Consider the total combined length of your vehicle and trailer and ensure that the vehicle-to-vehicle distance is sufficient before executing lane changes.

**■ Transmission information****▶ Multidrive**

To maintain engine braking efficiency and charging system performance when using engine braking, do not use the transmission in D, must be in M and select gear step 4 or lower. (→P. 211)

**▶ Multi-mode manual transmission**

Select an appropriate gear in M position to maintain the effectiveness of engine braking and to maintain charging system performance. (→P. 214)

**▶ Manual transmission**

Refrain from driving in 6th gear to maintain the effectiveness of engine braking and to maintain charging system performance.

**■ If the engine overheats**

Towing a loaded trailer up a long, steep incline in temperatures exceeding 30°C (85°F) may result in the engine overheating. If the engine coolant temperature gauge indicates that the engine is overheating, turn the air conditioning off immediately, leave the road and stop the vehicle in a safe place. (→P. 584)

**■ When parking the vehicle**

Always place wheel chocks under the wheels of both the vehicle and trailer. Firmly set the parking brake and shift the shift lever to P (Multidrive), E, M or R (multi-mode manual transmission) and 1 or R (manual transmission).

**⚠ WARNING**

Follow all the instructions described in this section. Failure to do so could cause an accident resulting in death or serious injury.

**■ Trailer towing precautions**

When towing, make sure that none of the weight limits are exceeded. (→P. 189)

**■ Vehicle speed in towing**

Observe the legal maximum speeds for trailer towing.

**■ Before descending hills or long declines**

Reduce speed and downshift. However, never downshift suddenly while descending steep or long downhill grades.

**■ Operation of the brake pedal**

Do not hold the brake pedal depressed often or for long periods of time. Doing so may result in the brake overheating or reduce braking effects.

**■ To avoid accident or injury**

- Vehicles with a cruise control: Do not use cruise control when you are towing.
- Vehicles with a compact spare tire: Do not tow a trailer when the compact spare tire is installed on your vehicle.
- Vehicles with an emergency tire puncture repair kit: Do not tow the vehicle when the tire installed is repaired with the emergency tire puncture repair kit.

**⚠ NOTICE****■ Do not directly splice trailer lights**

Directly splicing trailer lights may damage your vehicle's electrical system and cause a malfunction.

## Engine (ignition) switch (vehicles without a smart entry & start system)

### Starting the engine

#### ► Multidrive

- 1 Check that the parking brake is set.
- 2 Check that the shift lever is set in P.
- 3 Sit in the driver's seat and firmly depress the brake pedal.
- 4 Turn the engine switch to the "START" position and start the engine.

#### ► Multi-mode manual transmission

- 1 Check that the parking brake is set.
- 2 Firmly depress the brake pedal, turn the engine switch to the "ON" position and shift the shift lever to N.  
☹☹ turns on.
- 3 After ☹☹ goes out, turn the engine switch to the "START" position and start the engine.

#### ► Manual transmission (gasoline engine)

- 1 Check that the parking brake is set.
- 2 Check that the shift lever is set in N.
- 3 Firmly depress the clutch pedal.
- 4 Turn the engine switch to the "START" position and start the engine.

#### ► Manual transmission (diesel engine)

- 1 Check that the parking brake is set.
- 2 Check that the shift lever is set in N.
- 3 Firmly depress the clutch pedal.
- 4 Turn the engine switch to the "ON" position.  
☹☹ turns on.
- 5 After ☹☹ goes out, turn the engine switch to the "START" position and start the engine.



### Changing the engine switch positions

#### ① "LOCK"

The steering wheel is locked and the key can be removed. (vehicles with a Multidrive: The key can be removed only when the shift lever is in P.)

#### ② "ACC"

Some electrical components such as the audio system can be used.

#### ③ "ON"

All electrical components can be used.

#### ④ "START"

For starting the engine.

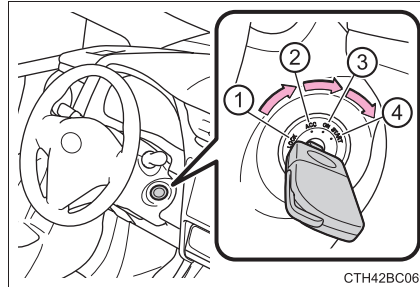

#### ■ If the engine does not start

The engine immobilizer system may not have been deactivated. (→P. 77)  
Contact any authorized Toyota dealer or repairer, or another duly qualified and equipped professional.

#### ■ When the steering lock cannot be released

When starting the engine, the engine switch may seem stuck in the "LOCK" position. To free it, turn the key while turning the steering wheel slightly left and right.

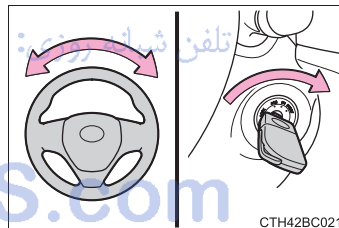

#### ■ Key reminder function

A buzzer sounds if the driver's door is opened while the engine switch is in the "LOCK" or "ACC" position to remind you to remove the key.

 WARNING**■ When starting the engine**

Always start the engine while sitting in the driver's seat. Do not depress the accelerator pedal while starting the engine under any circumstances. Doing so may cause an accident resulting in death or serious injury.

**■ Caution when driving**

Do not turn the engine switch to the "LOCK" position while driving. If, in an emergency, you must turn the engine off while the vehicle is moving, turn the engine switch only to the "ACC" position to stop the engine. An accident may result if the engine is stopped while driving. (→P. 503)

 NOTICE**■ To prevent battery discharge**

Do not leave the engine switch in the "ACC" or "ON" position for long periods of time without the engine running.

**■ When starting the engine**

- Do not crank the engine for more than 30 seconds at a time. This may overheat the starter and wiring system.
- Do not race a cold engine.
- If the engine becomes difficult to start or stalls frequently, have your vehicle checked by any authorized Toyota dealer or repairer, or another duly qualified and equipped professional immediately.

FarmaSOS.com

## Engine (ignition) switch (vehicles with a smart entry & start system)

Performing the following operations when carrying the electronic key on your person starts the engine or changes engine switch modes.

### Starting the engine

- 1 Check that the parking brake is set.
  - ▶ Vehicles with a drive monitor display
- 2 Multidrive: Check that the shift lever is set in P. Firmly depress the brake pedal.

Multi-mode manual transmission: Firmly depress the brake pedal, press the engine switch at once and shift the shift lever to N.

Manual transmission: Check that the shift lever is set in N. Firmly depress the clutch pedal.



The smart entry & start system indicator light (green) will turn on. If the indicator light does not turn on, the engine cannot be started.

- 3 Press the engine switch shortly and firmly.

When operating the engine switch, one short, firm press is enough. It is not necessary to press and hold the switch.

The engine will crank until it starts or for up to 30 seconds, whichever is less.

Continue depressing the brake pedal (Multidrive or multi-mode manual transmission) or clutch pedal (manual transmission) until the engine is completely started.

Diesel engine:  turns on. The engine begins starting after  goes out.

The engine can be started from any engine switch mode.

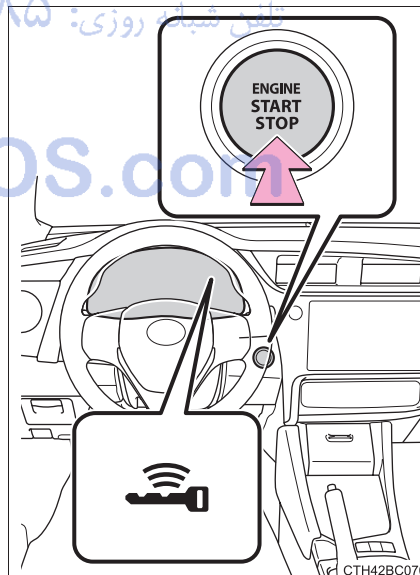

► Vehicles with a multi-information display

- 2 Multidrive: Check that the shift lever is set in P. Firmly depress the brake pedal.

Multi-mode manual transmission: Firmly depress the brake pedal, press the engine switch at once and shift the shift lever to N.

Manual transmission: Check that the shift lever is set in N. Firmly depress the clutch pedal.





will be displayed on the multi-information display.

If it is not displayed, the engine cannot be started.

- 3 Press the engine switch.

The engine will crank until it starts or for up to 30 seconds, whichever is less.

Continue depressing the brake pedal (Multidrive or multi-mode manual transmission) or clutch pedal (manual transmission) until the engine is completely started.

Diesel engine:  turns on. The engine begins starting after  goes out.

The engine can be started from any engine switch mode.

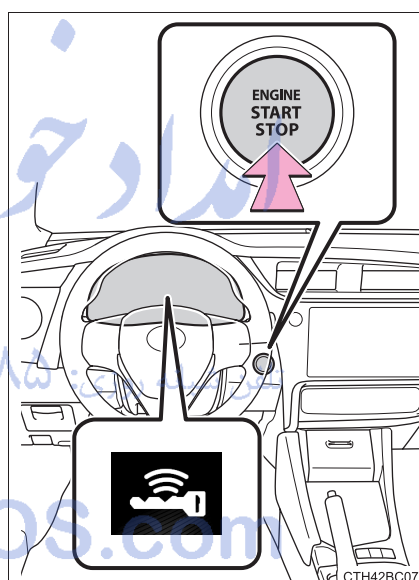

**Stopping the engine**

- 1 Stop the vehicle.
- 2 Multidrive: Shift the shift lever to P.  
Multi-mode manual transmission: Shift the shift lever to E, M or R.  
Manual transmission: Shift the shift lever to N.
- 3 Set the parking brake. (→P. 223)
- 4 Press the engine switch.
- 5 Vehicles with a drive monitor display: Release the brake pedal (Multidrive or multi-mode manual transmission) or clutch pedal (manual transmission) and check that the smart entry & start system indicator light (green) is off.  
Vehicles with a multi-information display: Release the brake pedal (Multidrive or multi-mode manual transmission) or clutch pedal (manual transmission) and check that "Power ON." on the multi-information display is off.

تلفن شبانه روزی: ۰۲۱-۸۸۶۲۰۸۵

FarmaSOS.com

### Changing engine switch modes

Modes can be changed by pressing the engine switch with the brake pedal (except vehicles with a manual transmission) or clutch pedal (vehicles with a manual transmission) released. (The mode changes each time the switch is pressed.)

► Vehicles with a drive monitor display

#### Off\*

The emergency flashers can be used.

The smart entry & start system indicator light (green) is off.

#### ACCESSORY mode

Some electrical components such as the audio system can be used.

The smart entry & start system indicator light (green) flashes slowly.

#### IGNITION ON mode

All electrical components can be used.

The smart entry & start system indicator light (green) flashes slowly.

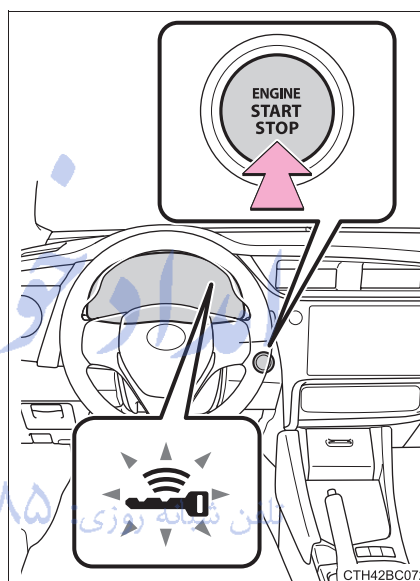

\*: Vehicles with a Multidrive: If the shift lever is in a position other than P when turning off the engine, the engine switch will be turned to ACCESSORY mode, not to off.

► Vehicles with a multi-information display

Off\*

The emergency flashers can be used.

The multi-information display will not be displayed.

ACCESSORY mode

Some electrical components such as the audio system can be used.

“Power ON.” will be displayed on the multi-information display.

IGNITION ON mode

All electrical components can be used.

“Power ON.” will be displayed on the multi-information display.

\*: Vehicles with a Multidrive: If the shift lever is in a position other than P when turning off the engine, the engine switch will be turned to ACCESSORY mode, not to off.

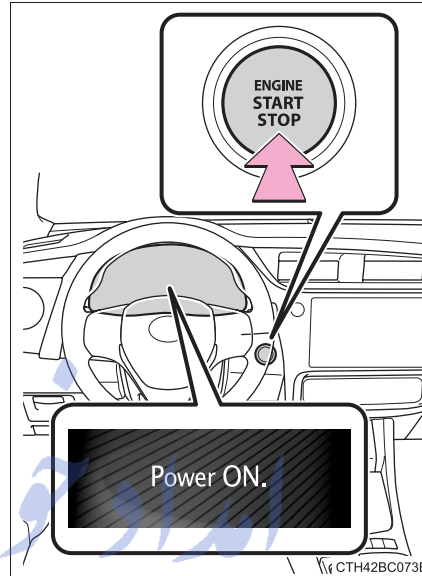

تلفن شبانه روزی: ۰۲۱-۸۸۶۲۰۸۵

FarmaSOS.com

**When stopping the engine with the shift lever in a position other than P (vehicles with a Multidrive)**

If the engine is stopped with the shift lever in a position other than P, the engine switch will not be turned off but instead be turned to ACCESSORY mode. Perform the following procedure to turn the switch off:

- 1 Check that the parking brake is set.
- 2 Shift the shift lever to P.
  - ▶ Vehicles with a drive monitor display
- 3 Check that the smart entry & start system indicator light (green) flashes slowly and then press the engine switch once.
- 4 Check that the smart entry & start system indicator light (green) is off.
  - ▶ Vehicles with a multi-information display
- 3 Check that “Power ON.” and “Turn power OFF.” are displayed alternately on the multi-information display and then press the engine switch once.
- 4 Check that “Power ON.” and “Turn power OFF.” on the multi-information display are off.

FarmaSOS.com



**■ Auto power off function**

## ▶ Vehicles with a Multidrive

If the vehicle is left in ACCESSORY mode for more than 20 minutes or IGNITION ON mode (the engine is not running) for more than an hour with the shift lever in P, the engine switch will automatically turn off. However, this function cannot entirely prevent battery discharge. Do not leave the vehicle with the engine switch in ACCESSORY or IGNITION ON mode for long periods of time when the engine is not running.

## ▶ Vehicles with a multi-mode manual transmission or manual transmission

If the vehicle is left in ACCESSORY mode for more than 20 minutes or IGNITION ON mode (the engine is not running) for more than an hour, the engine switch will automatically turn off. However, this function cannot entirely prevent battery discharge. Do not leave the vehicle with the engine switch in ACCESSORY or IGNITION ON mode for long periods of time when the engine is not running.

**■ Electronic key battery depletion**

→P. 119

**■ Conditions affecting operation**

→P. 142

**■ Notes for the entry function**

→P. 143

**■ If the engine does not start**

- The engine immobilizer system may not have been deactivated. (→P. 77)  
Contact any authorized Toyota dealer or repairer, or another duly qualified and equipped professional.
- Vehicles with a Multidrive: Check that the shift lever is securely set in P. The engine may not start if the shift lever is displaced out of P.
  - ▶ Vehicles with a drive monitor display  
The smart entry & start system indicator light (green) will flash quickly.
  - ▶ Vehicles with a multi-information display  
“Shift to P position to start.” will be displayed on the multi-information display.

**■ Steering lock**

After turning the engine switch off and opening and closing the doors, the steering wheel will be locked due to the steering lock function. Operating the engine switch again automatically cancels the steering lock.

### ■ When the steering lock cannot be released

Vehicles with a drive monitor display: The smart entry & start system indicator light (green) will flash quickly.

Vehicles with a multi-information display: "Steering lock active." will be displayed on the multi-information display.

Vehicles with a Multidrive: Check that the shift lever is set in P. Press the engine switch while turning the steering wheel left and right.

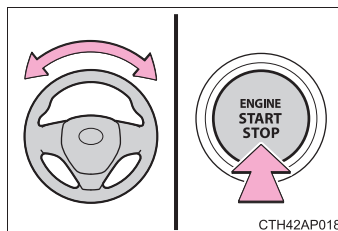

Vehicles with a multi-mode manual transmission or manual transmission: Press the engine switch while turning the steering wheel left and right.

### ■ Steering lock motor overheating prevention

To prevent the steering lock motor from overheating, the motor may be suspended if the engine is turned on and off repeatedly in a short period of time. In this case, refrain from operating the engine. After about 10 seconds, the steering lock motor will resume functioning.

### ■ When the smart entry & start system indicator light flashes in yellow (vehicles with a drive monitor display)

The system may be malfunctioning. Have the vehicle inspected by any authorized Toyota dealer or repairer, or another duly qualified and equipped professional immediately.

### ■ When "Check entry & start system." will be displayed on the multi-information display (vehicles with a multi-information display)

The system may be malfunctioning. Have the vehicle inspected by any authorized Toyota dealer or repairer, or another duly qualified and equipped professional immediately.

### ■ If the electronic key battery is depleted

→P. 480

### ■ Operation of the engine switch

- If the switch is not pressed shortly and firmly, the engine switch mode may not change or the engine may not start.
- If attempting to restart the engine immediately after turning the engine switch off, the engine may not start in some cases. After turning the engine switch off, please wait a few seconds before restarting the engine.

### ■ If the smart entry & start system has been deactivated in a customized setting

→P. 575

 **WARNING****■ When starting the engine**

Always start the engine while sitting in the driver's seat. Do not depress the accelerator pedal while starting the engine under any circumstances. Doing so may cause an accident resulting in death or serious injury.

**■ Caution while driving**

If engine failure occurs while the vehicle is moving, do not lock or open the doors until the vehicle reaches a safe and complete stop. Activation of the steering lock in this circumstance may lead to an accident, resulting in death or serious injury.

**■ Stopping the engine in an emergency**

If you want to stop the engine in an emergency while driving the vehicle, press and hold the engine switch for more than 2 seconds, or press it briefly 3 times or more in succession. (→P. 503)

However, do not touch the engine switch while driving except in an emergency. Turning the engine off while driving will not cause loss of steering or braking control, but the power assist to these systems will be lost. This will make it more difficult to steer and brake, so you should pull over and stop the vehicle as soon as it is safe to do so.

تلفن شبانه روزی: ۰۲۱-۸۸۶۲۰۸۵

FarmaSOS.com

 NOTICE**■ To prevent battery discharge**

- Do not leave the engine switch in ACCESSORY or IGNITION ON mode for long periods of time without the engine running.
- Vehicles with a drive monitor display:  
If the smart entry & start system indicator light (green) is illuminated, the engine switch is not off. When exiting the vehicle, always check that the engine switch is off.
- Vehicles with a multi-information display:  
If "Power ON." is displayed on the multi-information display, the engine switch is not off. When exiting the vehicle, always check that the engine switch is off.
- Vehicles with a Multidrive:  
Do not stop the engine when the shift lever is in a position other than P. If the engine is stopped in another shift lever position, the engine switch will not be turned off but instead be turned to ACCESSORY mode. If the vehicle is left in ACCESSORY mode, battery discharge may occur.

**■ When starting the engine**

- Do not race a cold engine.
- If the engine becomes difficult to start or stalls frequently, have your vehicle checked by any authorized Toyota dealer or repairer, or another duly qualified and equipped professional immediately.

**■ Symptoms indicating a malfunction with the engine switch**

If the engine switch seems to be operating somewhat differently than usual, such as the switch sticking slightly, there may be a malfunction. Contact any authorized Toyota dealer or repairer, or another duly qualified and equipped professional immediately.

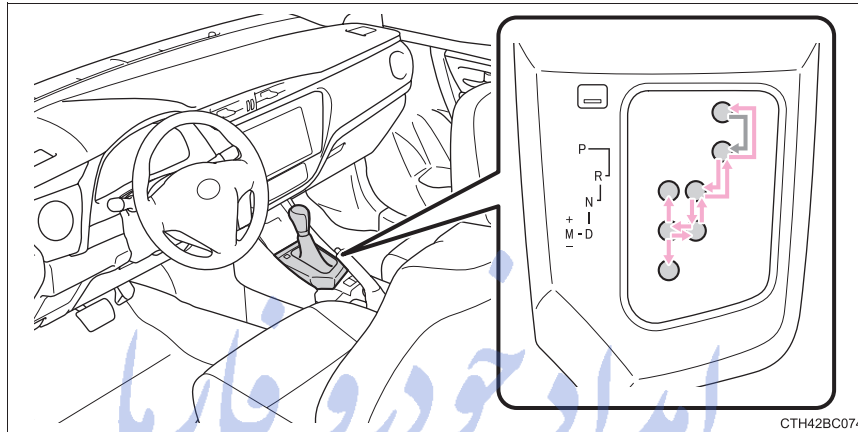
**Multidrive\*****Shifting the shift lever**

CTH42BC074

← Vehicles without a smart entry & start system:

While the engine switch is in the “ON” position, depress the brake pedal and move the shift lever.

Vehicles with a smart entry & start system:

While the engine switch is in IGNITION ON mode, depress the brake pedal and move the shift lever.

When shifting the shift lever between P and D, make sure that the vehicle is completely stopped.

4

Driving

\*: If equipped

**Shift position purpose**

Shift position	Objective or function
P	Parking the vehicle/starting the engine
R	Reversing
N	Neutral
D	Normal driving <sup>*1</sup>
M	7-speed sport sequential shiftmatic mode driving <sup>*2</sup> (→P. 211)

<sup>\*1</sup>: To improve fuel efficiency and reduce noises, set the shift lever in D for normal driving.

<sup>\*2</sup>: Selecting gear step using the M position achieves suitable engine braking forces by operating the shift lever.

**Sport mode**

Press the switch.

For powerful acceleration and driving in mountainous regions. Press the switch again to return to normal mode.

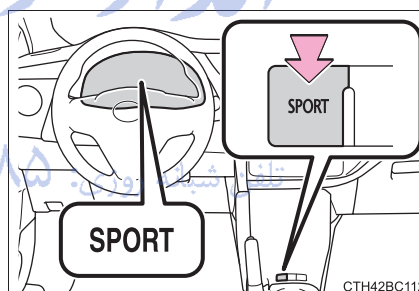

FarmaSOS.com

### Changing gear steps in the M position

To enter 7-speed sport sequential shiftmatic mode, shift the shift lever to M. Gear steps can then be selected by operating the shift lever, allowing you to drive in the gear step of your choosing.

① Upshifting

② Downshifting

The gear changes once every time the shift lever is operated.

The selected gear step, from M1 to M7, will be displayed in the meter.

\*1: Vehicles with a drive monitor display

\*2: Vehicles with a multi-information display

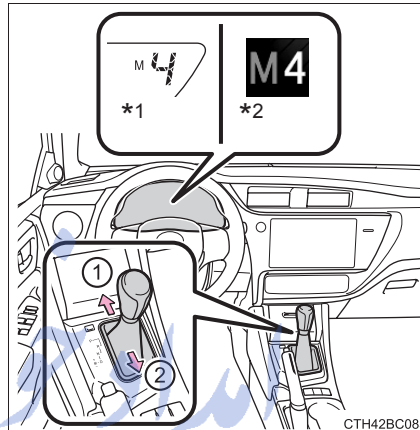

However, even when in the M position, the gear steps will be automatically changed if the engine speed is too high, or too low.

#### ■ Gear step functions

- You can choose from 7 levels of engine braking force.
- A lower gear step will provide greater engine braking force than a higher gear step, and the engine speed will also increase.

#### ■ If the 7-speed sport sequential shiftmatic mode indicator does not come on even after shifting the shift lever to M

This may indicate a malfunction in the Multidrive system. Have the vehicle inspected by any authorized Toyota dealer or repairer, or another duly qualified and equipped professional immediately.

(In this situation, the transmission will operate in the same manner as when the shift lever is in D.)

#### ■ When the vehicle comes to a stop with the shift lever in the M position

- The transmission will automatically downshift to M1 once the vehicle is stopped.
- After a stop, the vehicle will start off in M1.
- When the vehicle is stopped, the transmission is set at M1.

■ **When driving with cruise control activated (if equipped)**

Even when performing the following actions with the intent of enabling engine braking, engine braking will not activate because cruise control will not be canceled.

- While driving in D or 7-speed sport sequential shiftmatic mode, downshifting to 6, 5 or 4. (→P. 211)
- When switching the driving mode to sport mode while driving in D position. (→P. 210)

■ **Downshifting restrictions warning buzzer**

To help ensure safety and driving performance, downshifting operation may sometimes be restricted. In some circumstances, downshifting may not be possible even when the shift lever is operated. (A buzzer will sound twice.)

■ **Sport mode automatic deactivation**

Sport mode is automatically deactivated if the engine switch is turned off after driving in sport mode.

■ **If the shift lever cannot be shifted from P**

→P. 573

■ **G AI-SHIFT**

G AI-SHIFT automatically selects a suitable gear for sporty driving according to driver's input and driving conditions. G AI-SHIFT operates automatically when the shift lever is in D and sport mode is selected for the driving mode. (Selecting normal mode or shifting the shift lever to the M position cancels this function.)

 **WARNING**

■ **When driving on slippery road surfaces**

Be careful of downshifting and sudden acceleration, as this could result in the vehicle skidding to the side or spinning.



## Multi-mode Manual Transmission\*

### Shifting the shift lever

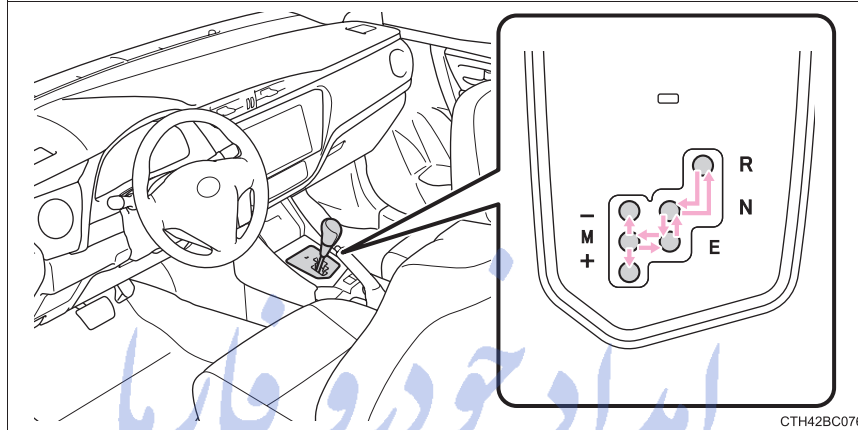

CTH42BC076

### Shift position uses

Shift position	Function
R	Reversing
N	Neutral or starting the engine
E	Easy (E) mode driving* <sup>1</sup>
M	Manual (M) mode driving* <sup>2</sup> (→P. 214)

\*<sup>1</sup>: The most appropriate gear position is automatically selected according to operation of the accelerator pedal and vehicle speed.

\*<sup>2</sup>: A gear position must be selected manually. However, the gear position may automatically be changed down optimally according to vehicle speed.

\*: If equipped

4

Driving

**Selecting the Easy sports (Es) mode (when the shift lever in E only)**

The Es mode can be selected for superior driving performance and to achieve a feeling of faster acceleration than in E mode.

Press the “Es” switch.

Press the switch once more to cancel the Es mode.

To improve fuel economy, cancel the Es mode for ordinary driving.

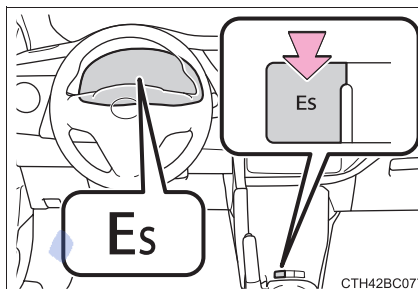

**Changing gear positions in M mode**

Shift the shift lever to M and operate the shift lever or paddle shift switch.

- ① Upshifting
- ② Downshifting

Shifting operation may be restricted depending on the vehicle speed.

- \*1: Vehicles with a drive monitor display
- \*2: Vehicles with a multi-information display

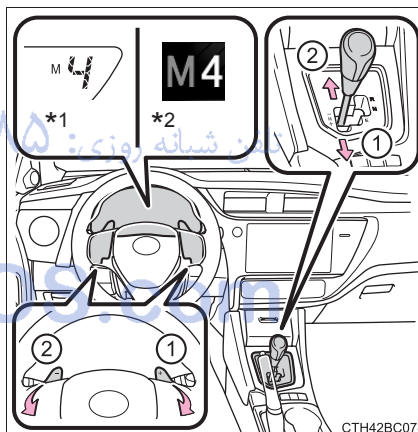

### Changing gear positions in E or Es mode

When the shift position is in E or Es, the paddle shift switches can be used to select a gear position temporarily. When a gear position is selected, the gear position will be displayed.

- ① Upshifting
- ② Downshifting

\*1: Vehicles with a drive monitor display

\*2: Vehicles with a multi-information display

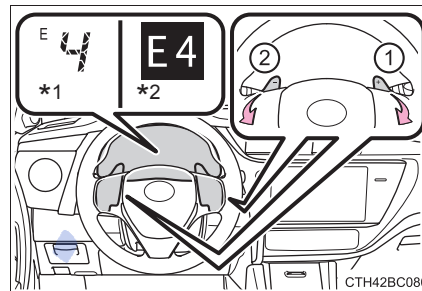

### Gear Shift Indicator

Gear Shift Indicator is a guide to help the driver achieve improved fuel economy and reduced exhaust emissions within limits of engine performance.

- ① Upshifting
- ② Downshifting

Gear Shift Indicator operates only in M mode.

\*1: Vehicles with a drive monitor display

\*2: Vehicles with a multi-information display

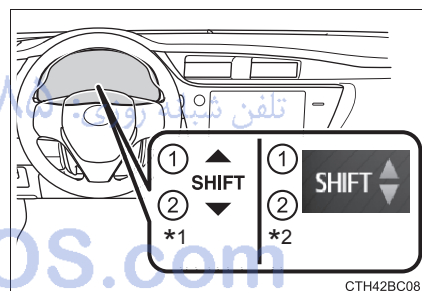

### ■ Maximum allowable speeds

Observe the following maximum allowable speeds in each gear when maximum acceleration is necessary.

km/h (mph)

Gear position	Maximum speed
1	42 (26)
2	79 (49)
3	115 (71)
4	156 (96)
5	—

### ■ Downshifting restrictions warning buzzer (in E mode [when the paddle shift switch is operated] or M mode)

To help ensure safety and driving performance, downshifting operation may sometimes be restricted. In some circumstances, downshifting may not be possible even when the shift lever or paddle shift switch is operated. (The warning buzzer will sound twice.)

### ■ Reverse warning buzzer

When shifting into R, a buzzer will sound to inform the driver that the shift lever is in R.

### ■ Es mode automatic deactivation

Es mode is automatically deactivated if the engine switch is turned off after driving in Es mode.

### ■ If the shift lever cannot be shifted

- With the shift lever in N  
Depress the brake pedal to shift the shift lever. If the shift lever cannot be shifted with your foot on the brake, there may be a problem with the shift lock system.
- With the shift lever in a position other than N  
→P. 574

### ■ If the driver's door is opened when the shift lever is in a position other than N and the engine is running

A buzzer will sound. Close the driver's door.

■ **If the parking brake is set when the shift lever is in a position other than N with engine running**

- When the driver's door is opened  
A buzzer will sound and the gear position will automatically change to N in 10 seconds.
- When the driver's door is closed  
A buzzer will sound and the gear position will automatically change to N in 90 seconds.

■ **If the M indicator does not come on even after shifting the shift lever to M**

This may indicate a malfunction in the multi-mode manual transmission system. Have the vehicle inspected by any authorized Toyota dealer or repairer, or another duly qualified and equipped professional immediately. (In this situation, the vehicle will operate as if the shift lever is in E.)

■ **If the N indicator is flashing**

- When shifting the shift lever:  
Shift the shift lever to N. Wait a few seconds and shift the shift lever to the desired position.
- When the engine is turned off:  
Vehicles without a smart entry & start system:  
Turn the engine switch to the "ON" position and shift the shift lever to N, and then to the desired position.  
Vehicles with a smart entry & start system:  
Turn the engine switch to IGNITION ON mode and shift the shift lever to N, and then to the desired position.

If the indicator still blinks after the above operations, shift the shift lever to N and start the engine. Then, shift the shift lever to the desired position.

■ **If the N indicator is flashing and the warning buzzer is beeping**

Shift the shift lever to N, and then to E, M or R.

 **WARNING**

■ **Gear Shift Indicator display**

For safety, the driver should not look only at the display. Refer to the display when it is safe to do so while considering actual traffic and road conditions. Failure to do so may lead to an accident.

## Manual transmission\*

### Shifting the shift lever

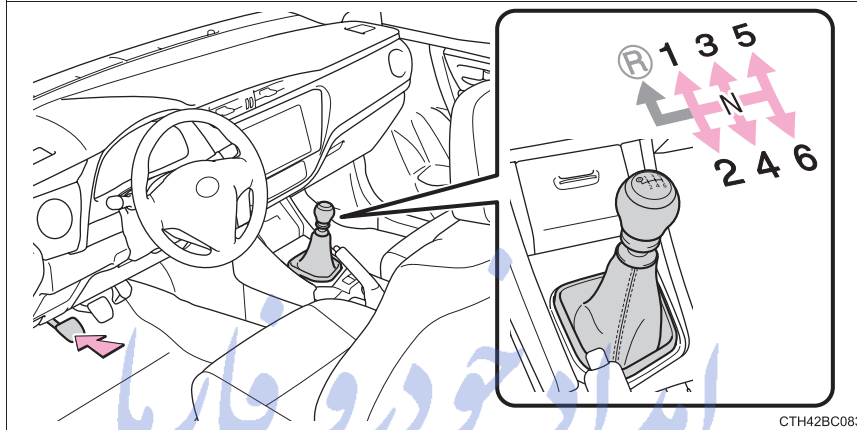

Fully depress the clutch pedal before operating the shift lever, and then release it slowly.

### Shifting the shift lever to R

Shift the shift lever to R while lifting up the ring section.

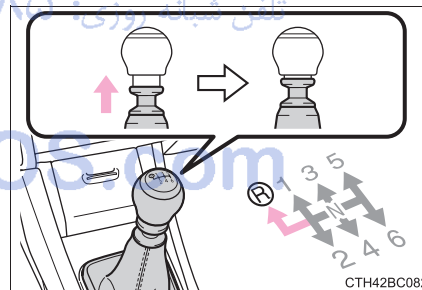

\*: If equipped

### Gear Shift Indicator

Gear Shift Indicator is a guide to help the driver achieve improved fuel economy and reduced exhaust emissions within limits of engine performance.

- ① Upshifting
- ② Downshifting

\*1: Vehicles with a drive monitor display

\*2: Vehicles with a multi-information display

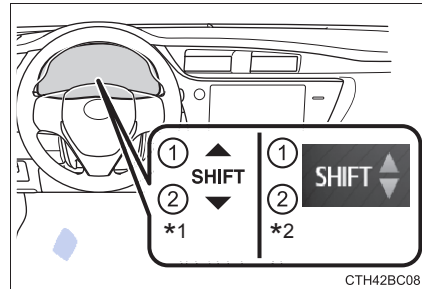

CTH42BC081

#### ■ Gear Shift Indicator display

Gear Shift Indicator may not be displayed when your foot is placed on the clutch pedal.

#### ■ Maximum allowable speeds

Observe the following maximum allowable speeds in each gear when maximum acceleration is necessary.

##### ▶ Gasoline engine

تلفن شبانه روزی: ۰۲۱-۸۸۶۲۰۸۵ km/h (mph)

Shift position	Maximum speed	
	1NR-FE engine	1ZR-FAE engine
1	44 (27)	50 (31)
2	82 (50)	94 (58)
3	112 (69)	137 (85)
4	152 (94)	185 (114)
5	179 (111)	—

## ► Diesel engine

km/h (mph)

Shift position	Maximum speed	
	1ND-TV engine	
	Vehicles without a Stop & Start system	Vehicles with a Stop & Start system
1	42 (26)	45 (27)
2	79 (49)	83 (51)
3	122 (75)	129 (80)
4	165 (102)	174 (108)
5	—	—

 **WARNING**
 **Gear Shift Indicator display**

For safety, the driver should not look only at the display. Refer to the display when it is safe to do so while considering actual traffic and road conditions. Failure to do so may lead to an accident.

تلفن شبانه روزی: ۰۲۱-۸۸۸۶۲۰۸۵

FarmaSOS.com



 NOTICE

## ■ To prevent damage to the transmission

- Do not shift the shift lever to R without depressing the clutch pedal.

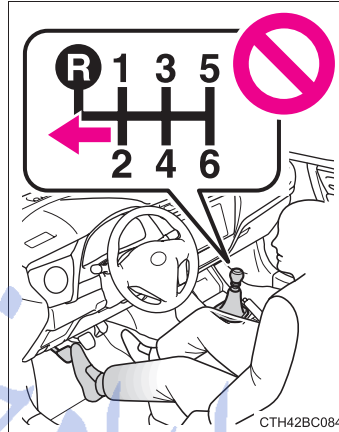

- Do not lift up the ring section except when shifting the lever to R.
- Shift the shift lever to R only when the vehicle is stationary.

4

Driving

تلفن شبانه روزی: ۰۲۱-۸۸۶۲۰۸۵

FarmaSOS.com

## Turn signal lever

### Operating instructions

- ① Right turn
- ② Lane change to the right (move the lever partway and release it)  
The right hand signals will flash 3 times.
- ③ Lane change to the left (move the lever partway and release it)  
The left hand signals will flash 3 times.
- ④ Left turn

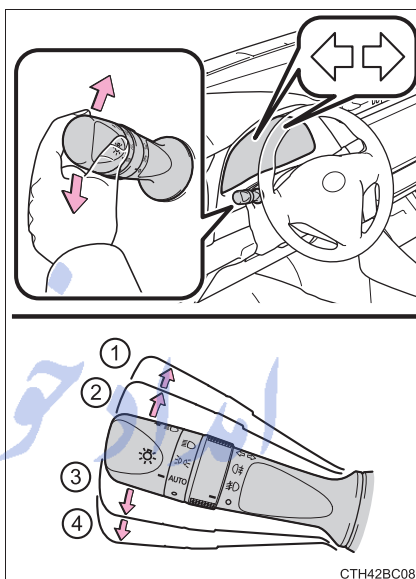

### ■ Turn signals can be operated when

- ▶ Vehicles without a smart entry & start system

The engine switch is in the "ON" position.

- ▶ Vehicles with a smart entry & start system

The engine switch is in IGNITION ON mode.

### ■ If the indicator flashes faster than usual

Check that a light bulb in the front or rear turn signal lights has not burned out.

### ■ Customization

The number of times the turn signals flash during a lane change can be changed. (Customizable feature →P. 611)

## Parking brake

### Operating instructions

- ① To set the parking brake, fully pull the parking brake lever while depressing the brake pedal.
- ② To release the parking brake, slightly raise the lever and lower it completely while pressing the button.

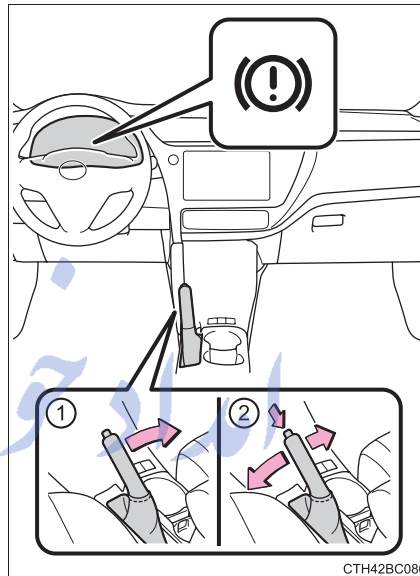

#### ■ Parking brake engaged warning buzzer

A buzzer will sound if the vehicle is driven at a speed of approximately 5 km/h (3 mph) or more with the parking brake engaged. (→P. 513, 526)

#### ■ Usage in winter time

→P. 323

#### ⚠ NOTICE

##### ■ Before driving

Fully release the parking brake.

Driving the vehicle with the parking brake set will lead to brake components overheating, which may affect braking performance and increase brake wear.

## Headlight switch

The headlights can be operated manually or automatically.

### Operating instructions

Turning the end of the lever turns on the lights as follows:

► Type A

- ① ○ Off  
The daytime running lights turn on.  
(→P. 227)
- ② ☞☞ The front position, tail, license plate and instrument panel lights turn on.
- ③ ☞D The headlights and all lights listed above turn on.

\*: If equipped

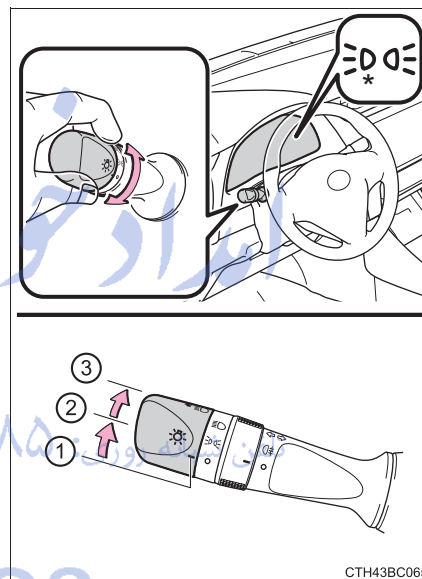

FarmaSOS.com

## ► Type B

- ① **AUTO** The headlights, daytime running lights (→P. 227) and all the lights listed below turn on and off automatically.  
(Vehicles without a smart entry & start system: When the engine switch is in the "ON" position)  
(Vehicles with a smart entry & start system: When the engine switch is in IGNITION ON mode)

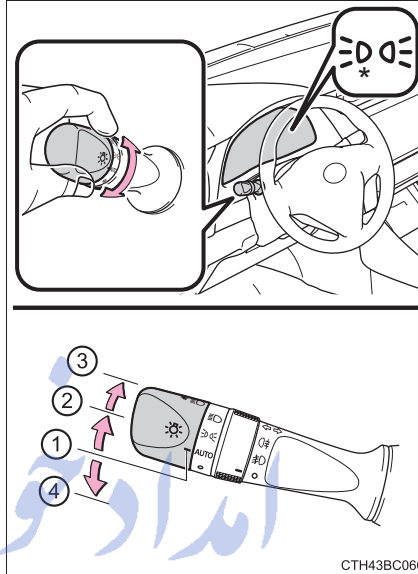

- ② The front position, tail, license plate and instrument panel lights turn on.
- ③ The headlights and all lights listed above turn on.
- ④ Off  
The daytime running lights turn on. (→P. 227)

\*: If equipped

FarmaSOS.com

### Turning on the high beam headlights

- ① With the headlights on, push the lever away from you to turn on the high beams.

Pull the lever toward you to the center position to turn the high beams off.

- ② Pull the lever toward you and release it to flash the high beams once.

You can flash the high beams with the headlights on or off.

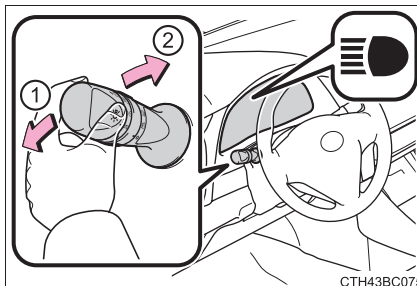

### Follow me home system

This system allows the headlights to be turned on for 30 seconds when the engine switch is turned off.

Pull the lever toward you and release it with the light switch is in **AUTO** or **○** after turning the engine switch off.

The lights are turned off in the following situations.

- Vehicles without a smart entry & start system: The engine switch is turned to the "ON" position
- Vehicles with a smart entry & start system: The engine switch is turned to IGNITION ON mode.
- The light switch is turned on.
- The light switch is pulled toward you and then released.

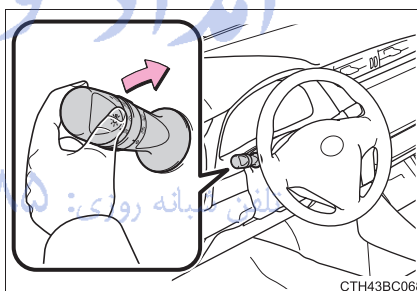

**Manual headlight leveling dial (vehicles with halogen headlights)**

The level of the headlights can be adjusted according to the number of passengers and the loading condition of the vehicle.

- ① Raises the level of the headlights
- ② Lowers the level of the headlights

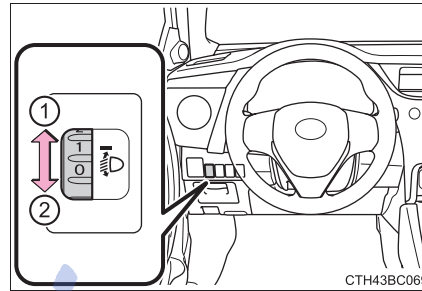
**■ Guide to dial settings**

Occupancy and luggage load conditions		Dial position
Occupants	Luggage load	
Driver	None	0
Driver and front passenger	None	0
All seats occupied	None	1.5
All seats occupied	Full luggage loading	3
Driver	Full luggage loading	4

**■ Daytime running light system**

To make your vehicle more visible to other drivers during daytime driving, the daytime running lights turn on automatically whenever the engine is started and the parking brake is released with the headlight switch off or in the **AUTO** position. (illuminate brighter than the front position lights.) Daytime running lights are not designed for use at night.

**■ Headlight control sensor (if equipped)**

The sensor may not function properly if an object is placed on the sensor, or anything that blocks the sensor is affixed to the windshield.

Doing so interferes with the sensor detecting the level of ambient light and may cause the automatic headlight system to malfunction.

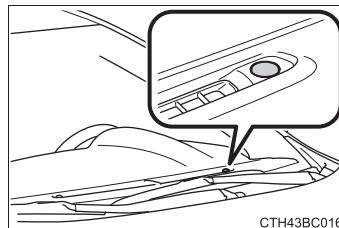



#### ■ Automatic light off system



- ▶ Vehicles without a smart entry & start system

When the light switch is in  or  : The headlights and front fog lights (if equipped) turn off automatically if the engine switch is turned off.



When the light switch is in **AUTO** : All lights turn off automatically if the engine switch is turned off.

To turn the lights on again, turn the engine switch to the “ON” position, or turn the light switch off once and then back to  or  .

- ▶ Vehicles with a smart entry & start system

When the light switch is in  or  : The headlights and front fog lights (if equipped) turn off automatically if the engine switch is turned off.

When the light switch is in **AUTO** : All lights turn off automatically if the engine switch is turned off.

To turn the lights on again, turn the engine switch to IGNITION ON mode, or turn the light switch off once and then back to  or  .

#### ■ Light reminder buzzer

- ▶ Vehicles without a smart entry & start system

A buzzer sounds when the engine switch is turned “LOCK” or to “ACC” position and the driver's door is opened while the lights are turned on.

- ▶ Vehicles with a smart entry & start system

A buzzer sounds when the engine switch is turned off or turned to ACCESSORY mode and the driver's door is opened while the lights are turned on.

#### ■ Automatic headlight leveling system (vehicles with LED headlights)

The level of the headlights is automatically adjusted according to the number of passengers and the loading condition of the vehicle to ensure that the headlights do not interfere with other road users.

#### ■ Battery-saving function

In the following conditions, the headlights and the other remaining lights will go off automatically after 20 minutes in order to prevent the vehicle battery from being discharged:

- The headlights and/or tail lights are on.
- The engine switch is in the “LOCK” position (vehicles without a smart entry & start system) or turned off (vehicles with a smart entry & start system).
- The light switch is in  or **AUTO** .

This function will be canceled in any of the following situations:

- When the engine switch is turned to the “ON” position (vehicles without a smart entry & start system) or IGNITION ON mode (vehicles with a smart entry & start system)
- When the light switch is operated
- When the door or trunk is opened or closed



**■ Customization**

Settings (e.g. light sensor sensitivity) can be changed.  
(Customizable features: →P. 611)

**⚠ WARNING****■ Manual headlight leveling dial precautions (if equipped)**

Observe the following precautions.

Failure to do so may lead to mishandling of the vehicle and cause an accident, resulting in death or serious injury.

- Do not adjust the headlight beam level while the vehicle is moving.
- Adjust the headlight level to the proper level before driving.

**⚠ NOTICE****■ To prevent battery discharge**

Do not leave the lights on longer than necessary when the engine is not running.

تلفن شبانه روزی: ۰۲۱-۸۸۶۲۰۸۵

FarmaSOS.com

## Fog light switch

The fog lights secure excellent visibility in difficult driving conditions, such as in rain and fog.

► Rear fog light switch

- ① ○ Turns the rear fog light off
- ② ⊖ Turns the rear fog light on

Releasing the switch ring returns it to ○ .

Operating the switch ring again turns the rear fog light off.

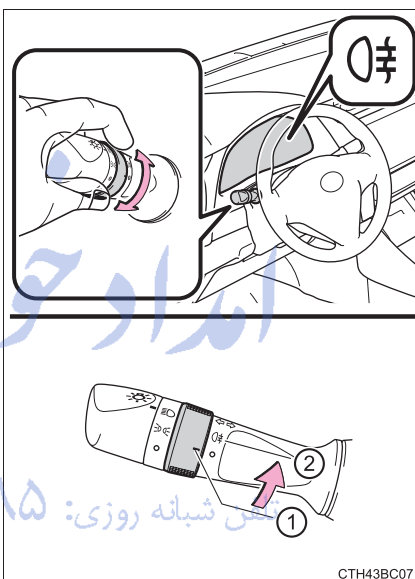

FarmaSOS.com

► Front and rear fog light switch

- ① ○ Turns the front and rear fog lights off
- ② ㊦ Turns the front fog lights on
- ③ ㊧ Turns both front and rear fog lights on

Releasing the switch ring returns it to ㊦.

Operating the switch ring again turns only the rear fog light off.

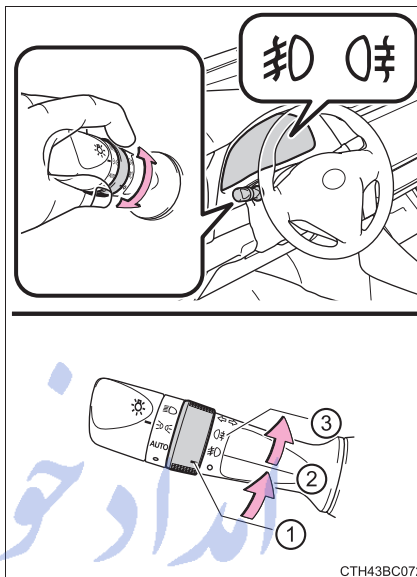

■ Fog lights can be used when

- Vehicles with a rear fog light switch
- Vehicles with a front and rear fog light switch

The headlights are turned on.

Front fog lights: The headlights or the front position lights are turned on.  
Rear fog light: The front fog lights are turned on.





FarmaSOS.com

## Windshield wipers and washer

### Operating the wiper lever

- ▶ Intermittent windshield wipers with interval adjuster

The wiper operation is selected by moving the lever as follows. When intermittent windshield wiper operation is selected, the wiper interval can be also adjusted.

- ①  Intermittent windshield wiper operation
- ②  Low speed windshield wiper operation
- ③  High speed windshield wiper operation
- ④  Temporary operation

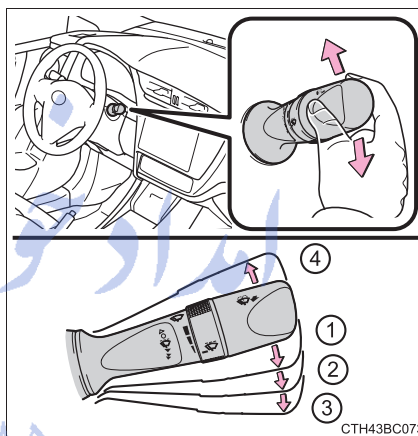

Wiper intervals can be adjusted when intermittent operation is selected.

- ⑤ Increases the intermittent windshield wiper frequency
- ⑥ Decreases the intermittent windshield wiper frequency

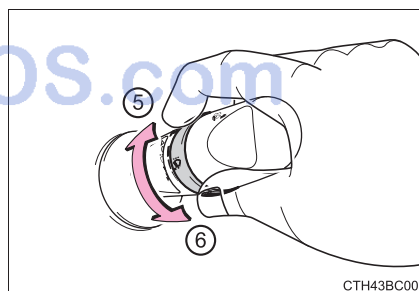

⑦ Washer/wiper dual operation

Wipers will automatically operate a couple of times after the washer squirts.

Vehicles with headlight cleaners: When the headlights are on and the lever is pulled and held, the headlight cleaners will operate once. After this, the headlight cleaners will operate every 5th time the lever is pulled.

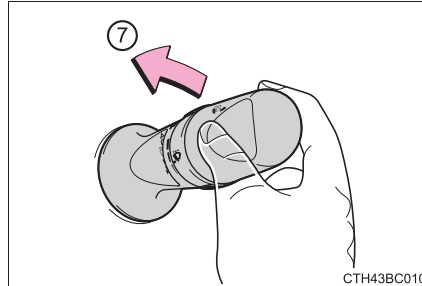

► Rain-sensing windshield wipers

When “AUTO” is selected, the wipers will operate automatically when the sensor detects falling rain. The system automatically adjusts wiper timing in accordance with rain volume and vehicle speed.

- ① **AUTO** Rain-sensing windshield wiper operation
- ② ▼ Low speed windshield wiper operation
- ③ ▼ High speed windshield wiper operation
- ④ ▲ Temporary operation

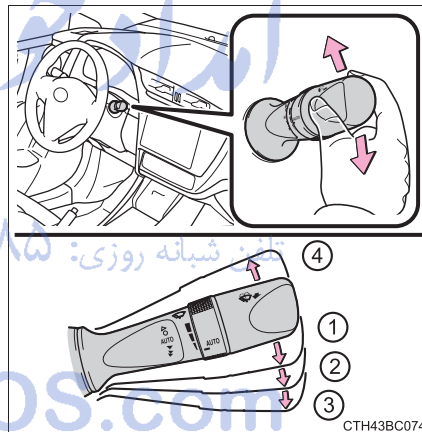

When "AUTO" is selected, the sensor sensitivity can be adjusted as follows by turning the switch ring.

- ⑤ Increases the rain-sensing windshield wiper sensitivity
- ⑥ Decreases the rain-sensing windshield wiper sensitivity

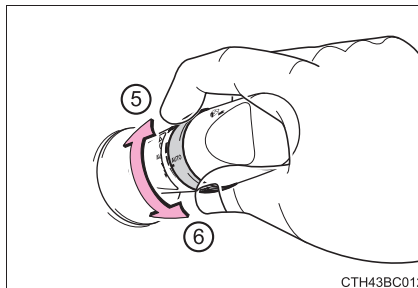

- ⑦ Washer/wiper dual operation  
Wipers will automatically operate a couple of times after the washer squirts.  
Vehicles with headlight cleaners:  
When the headlights are on and the lever is pulled and held, the headlight cleaners will operate once. After this, the headlight cleaners will operate every 5th time the lever is pulled.

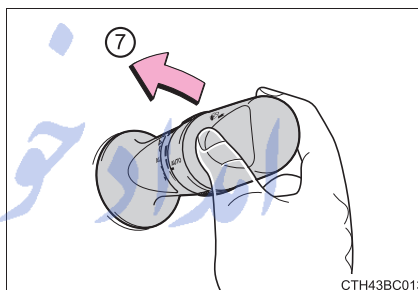

■ **The windshield wiper and washer can be operated when**

- ▶ Vehicles without a smart entry & start system

The engine switch is in the "ON" position.

- ▶ Vehicles with a smart entry & start system

The engine switch is in IGNITION ON mode.

■ **Effects of vehicle speed on wiper operation (vehicles with rain-sensing windshield wipers)**

Even when the wipers are not in "AUTO" mode, wiper operation varies depending on vehicle speed when the washer is being used (delay until drip prevention wiper sweep occurs).

### ■ Raindrop sensor (vehicles with rain-sensing windshield wipers)

- The raindrop sensor judges the amount of raindrops.

An optical sensor is adopted. It may not operate properly when sunlight from the rising or setting of the sun intermittently strikes the windshield, or if bugs etc. are present on the windshield.

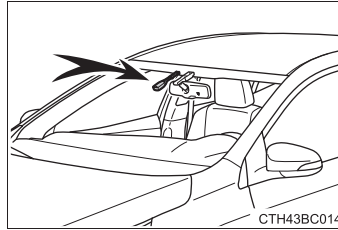

- Vehicles without a smart entry & start system: If the wiper switch is turned to the "AUTO" position while the engine switch is in the "ON" position, the wiper will operate once to show that "AUTO" mode is activated.

Vehicles with a smart entry & start system: If the wiper switch is turned to the "AUTO" position while the engine switch is in IGNITION ON mode, the wiper will operate once to show that "AUTO" mode is activated.

- If the temperature of the raindrop sensor is 90°C (194°F) or higher, or -15°C (5°F) or lower, automatic operation may not occur. In this case, operate the wipers in any mode other than "AUTO".

### ■ If no windshield washer fluid sprays

Check that the washer nozzles are not blocked if there is washer fluid in the windshield washer fluid reservoir.

#### ⚠ WARNING

#### ■ Caution regarding the use of washer fluid

When it is cold, do not use the washer fluid until the windshield becomes warm. The fluid may freeze on the windshield and cause low visibility. This may lead to an accident, resulting in death or serious injury.

#### ■ Caution regarding the use of windshield wipers in "AUTO" mode (vehicles with rain-sensing windshield wipers)

The windshield wipers may operate unexpectedly if the sensor is touched or the windshield is subject to vibration in "AUTO" mode. Take care that your fingers etc. do not become caught in the windshield wipers.



## NOTICE

**■ When the windshield is dry**

Do not use the wipers, as they may damage the windshield.

**■ When the washer fluid tank is empty**

Do not operate the switch continually as the washer fluid pump may over-heat.

**■ When a nozzle becomes blocked**

In this case, contact any authorized Toyota dealer or repairer, or another duly qualified and equipped professional.

Do not try to clear it with a pin or other object. The nozzle will be damaged.

امداد خودرو فارما

تلفن شبانه روزی: ۰۲۱-۸۸۸۶۲۰۸۵

FarmaSOS.com



## Opening the fuel tank cap

Perform the following steps to open the fuel tank cap:

### Before refueling the vehicle

- Close all the doors and windows, and turn the engine switch off.
- Confirm the type of fuel.

### Fuel types

→P. 609

### Fuel tank opening for unleaded gasoline (gasoline engine)

To help prevent incorrect fueling, your vehicle has a fuel tank opening that only accommodates the special nozzle on unleaded fuel pumps.

امداد خودرو فارما

تلفن شبانه روزی: ۰۲۱-۸۸۸۶۲۰۸۵

FarmaSOS.com

 WARNING**■ When refueling the vehicle**

Observe the following precautions while refueling the vehicle. Failure to do so may result in death or serious injury.

- After exiting the vehicle and before opening the fuel door, touch an unpainted metal surface to discharge any static electricity. It is important to discharge static electricity before refueling because sparks resulting from static electricity can cause fuel vapors to ignite while refueling.
- Always hold the grips on the fuel tank cap and turn it slowly to remove it. A whooshing sound may be heard when the fuel tank cap is loosened. Wait until the sound cannot be heard before fully removing the cap. In hot weather, pressurized fuel may spray out the filler neck and cause injury.
- Do not allow anyone that has not discharged static electricity from their body to come close to an open fuel tank.
- Do not inhale vaporized fuel.  
Fuel contains substances that are harmful if inhaled.
- Do not smoke while refueling the vehicle.  
Doing so may cause the fuel to ignite and cause a fire.
- Do not return to the vehicle or touch any person or object that is statically charged.  
This may cause static electricity to build up, resulting in a possible ignition hazard.

**■ When refueling**

Observe the following precautions to prevent fuel overflowing from the fuel tank:

- Securely insert the fuel nozzle into the fuel filler neck.
- Stop filling the tank after the fuel nozzle automatically clicks off.
- Do not top off the fuel tank.

 NOTICE**■ Refueling**

Do not spill fuel during refueling.

Doing so may damage the vehicle, such as causing the emission control system to operate abnormally or damaging fuel system components or the vehicle's painted surface.

**Opening the fuel tank cap**

- 1 Pull up the opener to open the fuel filler door.

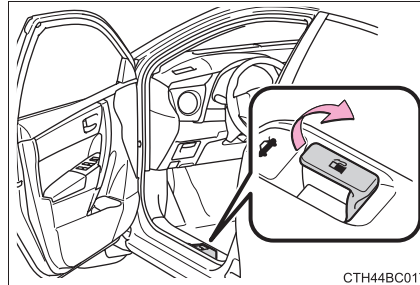

- 2 Turn the fuel tank cap slowly to remove it and hang it on the back of the fuel filler door.

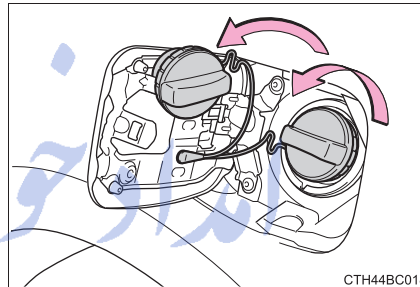
**Closing the fuel tank cap**

After refueling, turn the fuel tank cap until you hear a click. Once the cap is released, it will turn slightly in the opposite direction.

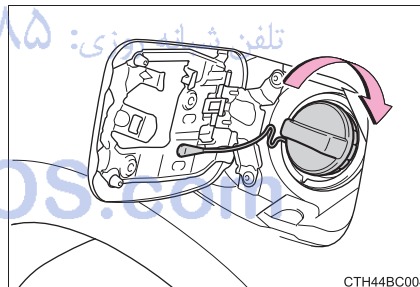
**⚠ WARNING****■ When replacing the fuel tank cap**

Do not use anything but a genuine Toyota fuel tank cap designed for your vehicle. Doing so may cause a fire or other incident which may result in death or serious injury.

## Toyota Safety Sense\*

The Toyota Safety Sense consists of the following drive assist systems and contributes to a safe and comfortable driving experience.

◆ **PCS (Pre-Crash Safety system)**

→P. 246

◆ **LDA (Lane Departure Alert)**

→P. 259

◆ **Automatic High Beam**

→P. 264

◆ **RSA (Road Sign Assist)**

→P. 268

 **WARNING**

■ **Toyota Safety Sense**

The Toyota Safety Sense is designed to operate under the assumption that the driver will drive safely, and is designed to help reduce the impact to the occupants and the vehicle in the case of a collision or assist the driver in normal driving conditions.

As there is a limit to the degree of recognition accuracy and control performance that this system can provide, do not overly rely on this system. The driver is always responsible for paying attention to the vehicle's surroundings and driving safely.

\*: If equipped

### Vehicle data recording

The pre-crash safety system is equipped with a sophisticated computer that will record certain data, such as:

- Accelerator status
- Brake status
- Vehicle speed
- Operation status of the pre-crash safety system functions
- Information (such as the distance and relative speed between your vehicle and the vehicle ahead or other objects)

#### ● Data usage

Toyota may use the data recorded in this computer to diagnose malfunctions, conduct research and development, and improve quality.

Toyota will not disclose the recorded data to a third party except:

- With the consent of the vehicle owner or with the consent of the lessee if the vehicle is leased
- In response to an official request by the police, a court of law or a government agency
- For use by Toyota in a lawsuit
- For research purposes where the data is not tied to a specific vehicle or vehicle owner

4

Driving

### Front sensor

The front sensor is located on the upper side of the windshield. It consists of 2 types of sensors, each of which detects information necessary to operate the drive assist systems.

- ① Laser sensors
- ② Monocular camera sensor

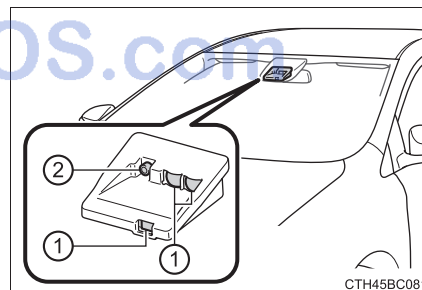

**⚠ WARNING****■ Front sensor**

The front sensor uses lasers to detect vehicles ahead of your vehicle. The front sensor is classified as class 1M laser product according to the IEC 60825-1 standard. Under normal usage conditions, these lasers are not harmful to the naked eye. However, it is necessary to observe the following precautions.

Failure to do so may result in the loss of eyesight or severe visual impairment.

- To avoid hazardous laser radiation exposure, never attempt to disassemble the front sensor (e.g. remove the lenses). When disassembled, the front sensor is classified as a class 3B laser product according to the IEC 60825-1 standard. Class 3B lasers are hazardous and pose a risk of eye injury under direct exposure.
- Do not attempt to look into the front sensor with a magnifying glass, microscope or other optical instrument within a distance of less than 100 mm (3.9 in.).

Laser classification label

**INVISIBLE LASER RADIATION  
DO NOT VIEW DIRECTLY WITH  
OPTICAL INSTRUMENTS (MAGNIFIERS)  
CLASS 1M LASER PRODUCT**

קרינת לייזר  
אין לחשוף משתמשים באופטיקה מגדילה  
מוצר לייזר ברמת סיכון 1M

Laser explanatory label

**Max average power: 45 mW  
Pulse duration: 33 ns  
Wavelength: 905 nm**

IEC 60825-1:2007  
Complies with FDA performance standards for laser products  
except for deviations pursuant to Laser Notice No. 50, dated  
**July 26<sup>th</sup>, 2001**

**⚠ WARNING**

## Laser emission data

Maximum average power: 45 mW  
 Pulse duration: 33 ns  
 Wave length: 905 nm  
 Divergence (horizontal x vertical): 28° x 12°

**■ To avoid malfunction of the front sensor**

Observe the following precautions.

Otherwise, the front sensor may not operate properly, possibly leading to an accident resulting in death or serious injury.

- Keep the windshield clean at all times. If the windshield is dirty or covered with an oily film, water droplets, snow, etc., clear the windshield. If the inner side of the windshield in front of the front sensor is dirty, contact any authorized Toyota dealer or repairer, or another duly qualified and equipped professional.

- Do not attach objects, such as stickers, transparent stickers, etc., and so forth, to the outer side of the windshield in front of the front sensor (shaded area in the illustration).

A: From the top of the windshield to approximately 10 cm (4.0 in.) below the bottom of the front sensor

B: Approximately 20 cm (7.9 in.) (Approximately 10 cm (4.0 in.) to the right and left from the center of the front sensor)

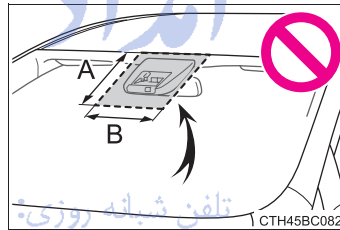

- Do not install or attach anything to the inner side of the windshield under the front sensor (shaded area in the illustration).

A: Approximately 10 cm (4.0 in.) (Starting from the bottom of the front sensor)

B: Approximately 20 cm (7.9 in.) (Approximately 10 cm (4.0 in.) to the right and left from the center of the front sensor)

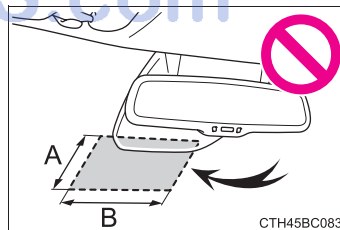

**⚠ WARNING**

- If there is a large difference in temperature between the inside and outside of the vehicle, such as in winter, the windshield is likely to fog up easily. If the part of the windshield in front of the front sensor is fogged up or covered with condensation or ice, the PCS warning light may flash and the system may be temporarily disabled. In this case, use the windshield defogger to remove the fog, etc. (→P. 394, 403)
- If the area of the windshield in front of the front sensor is covered with water droplets, use the windshield wipers to remove them.  
If the water droplets are not sufficiently removed, the performance of the front sensor may be reduced.
- If water droplets cannot be properly removed from the area of the windshield in front of the front sensor by the windshield wipers, replace the wiper insert or wiper blade.  
If the wiper inserts or wiper blades need to be replaced, contact any authorized Toyota dealer or repairer, or another duly qualified and equipped professional.
- Do not attach window tinting to the windshield.
- Replace the windshield if it is damaged or cracked.  
If the windshield needs to be replaced, contact any authorized Toyota dealer or repairer, or another duly qualified and equipped professional.
- Do not install an antenna in front of the sensor.
- Do not get the front sensor wet.
- Do not allow bright lights to shine into the front sensor.
- Do not dirty or damage the front sensor.  
When cleaning the inside of the windshield, do not allow glass cleaner to contact the lens. Also, do not touch the lens.  
If the lens is dirty or damaged, contact any authorized Toyota dealer or repairer, or another duly qualified and equipped professional.
- Do not subject the front sensor to a strong impact.
- Do not change the installation position or direction of the front sensor or remove it.
- Do not disassemble the front sensor.
- Do not install an electronic device or device that emits strong electric waves near the front sensor.
- Do not modify any components of the vehicle around the front sensor (inside rear view mirror, sun visors, etc.) or ceiling.
- Do not attach any accessories that may obstruct the front sensor to the hood, front grille or front bumper. Contact any authorized Toyota dealer or repairer, or another duly qualified and equipped professional for details.



 WARNING

- If a surfboard or other long object is to be mounted on the roof, make sure that it will not obstruct the front sensor.
- Do not modify the headlights or other lights.
- Do not attach anything to or place anything on the dashboard.

امداد خودرو فارما

تلفن شبانه روزی: ۰۲۱-۸۸۸۶۲۰۸۵

FarmaSOS.com

4

Driving

## PCS (Pre-Crash Safety system)\*

The pre-crash safety system uses the front sensor to detect vehicles in front of your vehicle. When the system determines that the possibility of a frontal collision with a vehicle is high, a warning operates to urge the driver to take evasive action and the potential brake pressure is increased to help the driver avoid the collision. If the system determines that the possibility of a frontal collision with a vehicle is extremely high, the brakes are automatically applied to help avoid the collision or help reduce the impact of the collision.

The pre-crash safety system can be disabled/enabled and the warning timing can be changed. (→P. 249)

### ◆ Pre-crash warning

When the system determines that the possibility of a frontal collision is high, a buzzer will sound and a warning message will be displayed on the multi-information display to urge the driver to take evasive action.

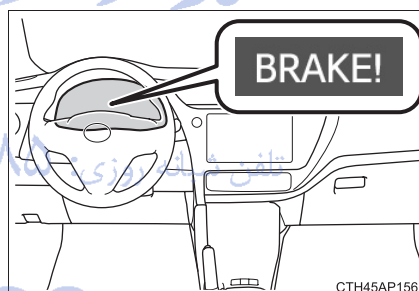

### ◆ Pre-crash brake assist

When the system determines that the possibility of a frontal collision with a vehicle is high, the system applies greater braking force in relation to how strongly the brake pedal is depressed.

### ◆ Pre-crash braking

When the system determines that the possibility of a frontal collision with a vehicle is high, the system warns the driver. If the system determines that the possibility of a collision is extremely high, the brakes are automatically applied to help avoid the collision or reduce the collision speed.

\*: If equipped

 **WARNING****■ Limitations of the pre-crash safety system**

- The driver is solely responsible for safe driving. Always drive safely, taking care to observe your surroundings.  
Do not use the pre-crash safety system instead of normal braking operations under any circumstances. This system will not prevent collisions or lessen collision damage or injury in every situation. Do not overly rely on this system. Failure to do so may lead to an accident, resulting in death or serious injury.
- Although this system is designed to help avoid and reduce the impact of a collision, its effectiveness may change according to various conditions, therefore the system may not always be able to achieve the same level of performance.  
Read the following conditions carefully. Do not overly rely on this system and always drive carefully.
  - Conditions under which the system may operate even if there is no possibility of a collision: →P. 251
  - Conditions under which the system may not operate properly: →P. 255
- Do not attempt to test the operation of the pre-crash safety system yourself, as the system may not operate properly, possibly leading to an accident.

**■ Pre-crash braking**

- The pre-crash braking function may not operate if certain operations are performed by the driver. If the accelerator pedal is being depressed strongly or the steering wheel is being turned, the system may determine that the driver is taking evasive action and possibly prevent the pre-crash braking function from operating.
- In some situations, while the pre-crash braking function is operating, operation of the function may be canceled if the accelerator pedal is depressed strongly or the steering wheel is turned and the system determines that the driver is taking evasive action.
- A large amount of braking force is applied while the pre-crash braking function is operating. Additionally, as the operation of the pre-crash braking function will be canceled after the vehicle has been stopped for approximately 2 seconds if it is stopped by the operation of the pre-crash braking function, the driver should depress the brake pedal as necessary.
- If the brake pedal is being depressed, the system may determine that the driver is taking evasive action and possibly delay the operation timing of the pre-crash braking function.

**⚠ WARNING**

● While driving, such as when driving through a railway crossing, the system may determine that the possibility of a collision with an object, such as railway crossing barrier, is high and operate the pre-crash braking function. To move the vehicle in an emergency, such as if the system operates in a railway crossing, perform the following operations and then take the necessary measures to ensure your safety.

- If the vehicle has been stopped, depress the accelerator pedal.
- If the vehicle is decelerating, fully depress the accelerator pedal. (→P. 250)
- Disable the pre-crash safety system. (→P. 249)

**■ When to disable the pre-crash safety system**

In the following situations, disable the system, as it may not operate properly, possibly leading to an accident resulting in death or serious injury:

- When the vehicle is being towed
- When your vehicle is towing another vehicle
- When transporting the vehicle via truck, boat, train or similar means of transportation
- When the vehicle is raised on a lift with the engine running and the tires are allowed to rotate freely
- When inspecting the vehicle using a drum tester such as a chassis dynamometer or speedometer tester, or when using an on vehicle wheel balancer
- If the vehicle cannot be driven in a stable manner, such as when the vehicle has been in an accident or is malfunctioning
- When the vehicle is driven in a sporty manner or off-road
- When the condition of the tires is poor and they do not perform well (→P. 460, 474)
- When tires of a size other than specified are installed
- When tire chains are installed
- When a compact spare tire or an emergency tire puncture repair kit is used

## Changing settings of the pre-crash safety system

### ■ Enabling/disabling the pre-crash safety system

Press the PCS switch for 3 seconds or more.

The PCS warning light will turn on and a message will be displayed on the multi-information display.

To enable the system, press the PCS switch again.

The pre-crash safety system is enabled each time the engine is started.

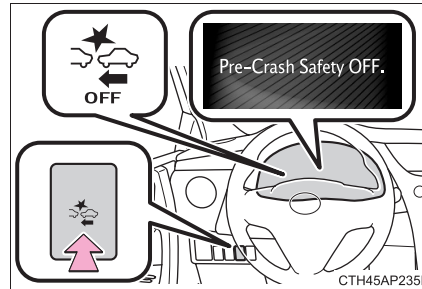

### ■ Changing the pre-crash warning timing

Press the PCS switch to display the current warning timing on the multi-information display. Each time the PCS switch is pressed in the displayed state, the timing for the warning changes as follows:

If the warning timing setting has been changed, the setting will be retained the next time the engine is started.

#### ① Far

The warning will begin to operate earlier than with the default timing.

#### ② Middle

This is the default setting.

#### ③ Near

The warning will begin to operate later than with the default timing.

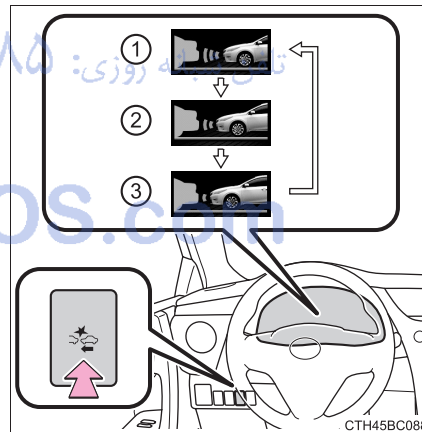

**Operational conditions**

The pre-crash safety system is enabled and determines that the possibility of a frontal collision with a vehicle is high.

Each function is operational at the following speeds:

- Pre-crash warning:
  - Vehicle speed is approximately 15 to 140 km/h (10 to 86 mph).
  - The relative speed between your vehicle and a preceding vehicle is approximately 15 km/h (10 mph) or more.
- Pre-crash brake assist:
  - Vehicle speed is approximately 30 to 80 km/h (19 to 49 mph).
  - The relative speed between your vehicle and a preceding vehicle is approximately 30 km/h (19 mph) or more.
- Pre-crash braking:
  - Vehicle speed is approximately 10 to 80 km/h (7 to 49 mph).
  - The relative speed between your vehicle and a preceding vehicle is approximately 10 km/h (7 mph) or more.

The system may not operate in the following situations:

- If a battery terminal has been disconnected and reconnected and then the vehicle has not been driven for a certain amount of time
- If the shift lever is in R
- If VSC is disabled (only the pre-crash warning function will be operational)
- If the PCS warning light is flashing or illuminated

**Cancellation of the pre-crash braking**

- If either of the following occur while the pre-crash braking function is operating, it will be canceled:
  - The accelerator pedal is depressed strongly.
  - The steering wheel is turned sharply or abruptly.
- If the vehicle is stopped by the operation of the pre-crash braking function, the operation of the pre-crash braking function will be canceled after the vehicle has been stopped for approximately 2 seconds.

■ **Conditions under which the system may operate even if there is no possibility of a collision**

● In some situations such as the following, the system may determine that there is a possibility of a frontal collision and operate.

- When passing a vehicle in an oncoming lane that is stopped to make a right/left turn

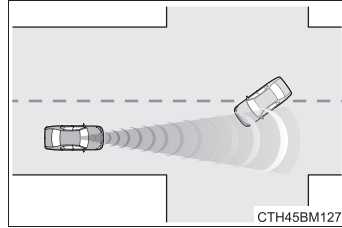

- When passing an oncoming vehicle while making a left or right turn

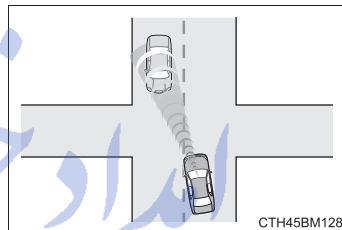

- When driving on a road where relative location to vehicle ahead in an adjacent lane may change, such as on a winding road

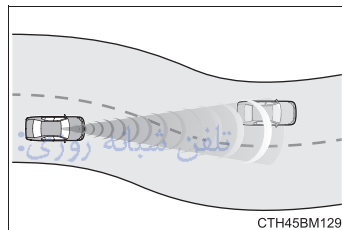

- When rapidly closing on a preceding vehicle

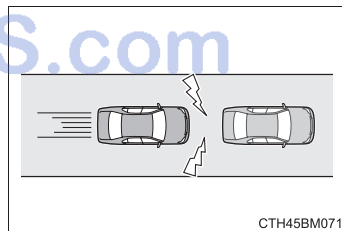

- If the front of the vehicle is raised or lowered, such as when the road surface is uneven or undulating

- When passing extremely close to a vehicle or structural object

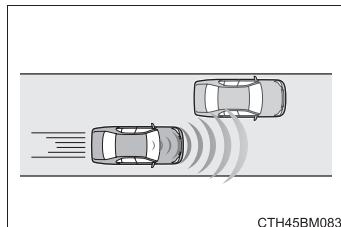

- When there is a vehicle or object by the roadside at the entrance of a curve

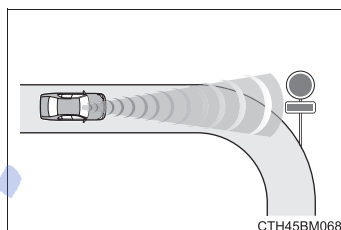

- When driving on a narrow path surrounded by a structure, such as in a tunnel or on an iron bridge

- When there is a reflective object (manhole cover, steel plate, etc.), steps, dip, or a protrusion on the road surface or roadside

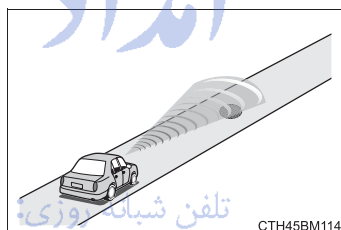

- When passing through a place with a low structure above the road (low ceiling, traffic sign, etc.)

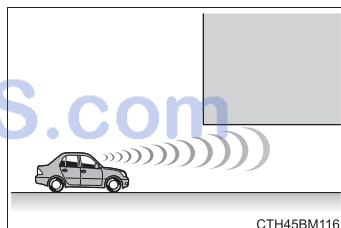

- When there is a structural object (overpass, traffic sign, billboard, street light, etc.) at the top of an uphill road

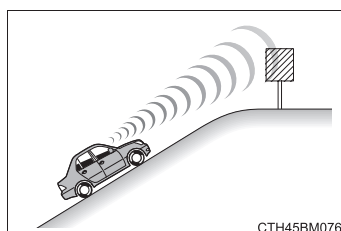



- When rapidly closing on an electric toll gate barrier, parking area barrier, or other barrier that opens and closes

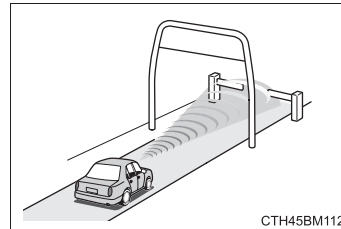

- When using an automatic car wash
- When approaching a low hanging object that may contact the vehicle, such as a banner, tree branches or thick grass

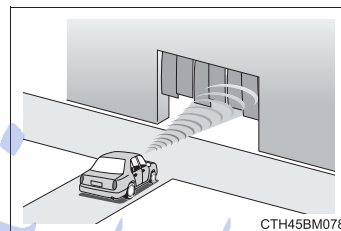

- When the vehicle is hit by water, snow, dust, etc. from a vehicle ahead

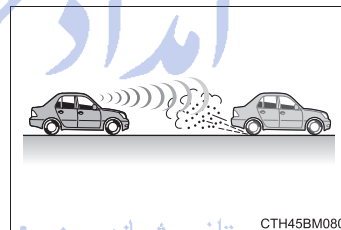

- When driving through steam or smoke

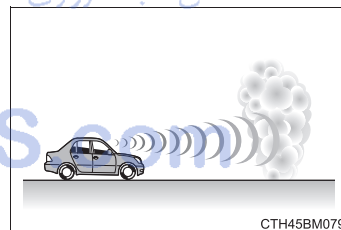

- When there are patterns or paint on the road or a wall that may be mistaken for a vehicle
- When the front part of the vehicle is raised or lowered

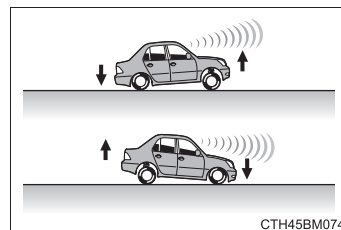

- When the sensor is misaligned due to a strong impact being applied to the sensor, etc.

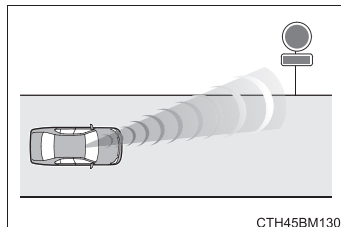

- When the vehicle is being parked in a place where there is a low hanging object at the height of the front sensor

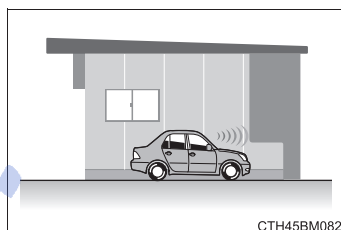

- When the windshield is covered with raindrops, etc.

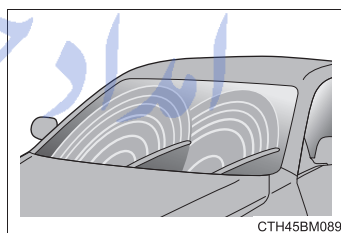

تلفن شبانه روزی: ۰۲۱-۸۸۸۶۲۰۸۵

FarmaSOS.com

### ■ Situations in which the system may not operate properly

● In some situations such as the following, a vehicle may not be detected by the front sensor, preventing the system from operating properly:

- If an oncoming vehicle is approaching your vehicle
- When approaching the side or front of a vehicle
- If a preceding vehicle has a small rear end, such as an unloaded truck
- If a preceding vehicle has a low rear end, such as a low bed trailer

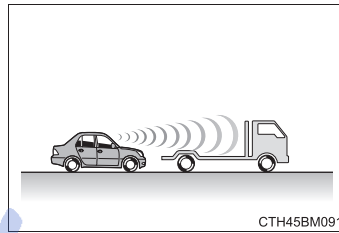

- If a vehicle ahead is carrying a load which protrudes past its rear bumper
- If a vehicle ahead has extremely high ground clearance

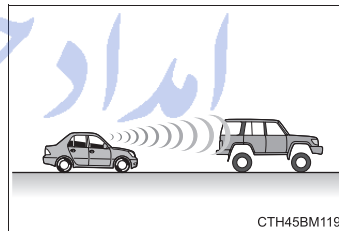

- If a vehicle ahead is irregularly shaped, such as a tractor or side car
- If the sun or other light is shining directly on a vehicle ahead
- If a vehicle cuts in front of your vehicle or emerges from beside a vehicle

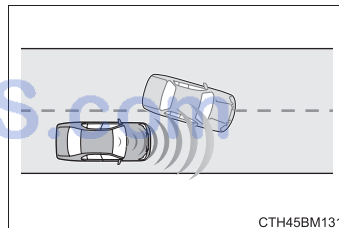

- If a vehicle ahead makes an abrupt maneuver (such as sudden swerving, acceleration or deceleration)
- When suddenly cutting behind a preceding vehicle

- When a vehicle ahead is not directly in front of your vehicle

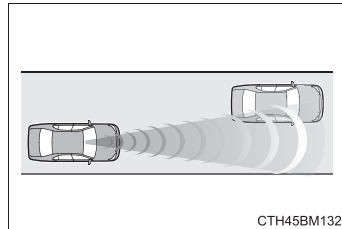

- When driving in inclement weather such as heavy rain, fog, snow or a sand storm



- When the vehicle is hit by water, snow, dust, etc. from a vehicle ahead
- When driving through steam or smoke that may obscure vehicles ahead
- When driving in a place where the surrounding brightness changes suddenly, such as at the entrance or exit of a tunnel
- When a very bright light, such as the sun or the headlights of oncoming traffic, shines directly into the front sensor

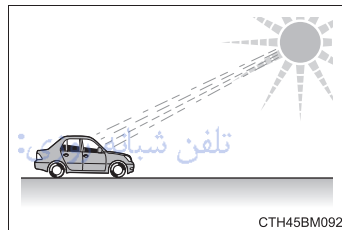

- When the surrounding area is dim, such as at dawn or dusk, or while at night or in a tunnel

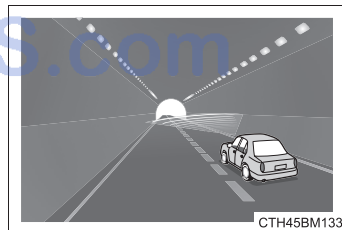

- While driving on a curve and for a certain amount of time after driving on a curve

- If your vehicle is skidding

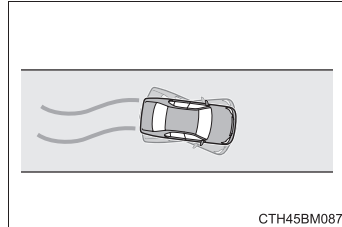

- When the front part of the vehicle is raised or lowered

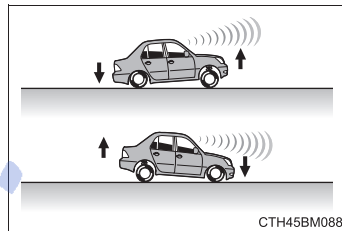

- If the wheels are misaligned
- If a wiper blade is blocking the front sensor
- The vehicle is wobbling.
- The vehicle is being driven at extremely high speeds.
- When driving on roads with sharp bends or uneven surfaces
- When a preceding vehicle is a poor reflector of laser
- When the sensor is misaligned due to a strong impact being applied to the sensor, etc.

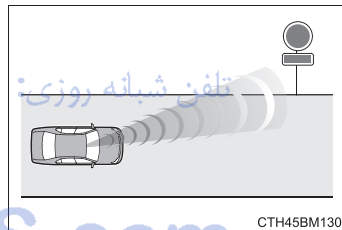

- In some situations such as the following, sufficient braking force may not be obtained, preventing the system from performing properly:
  - If the braking functions cannot operate to their full extent, such as when the brake parts are extremely cold, extremely hot, or wet
  - If the vehicle is not properly maintained (brakes or tires are excessively worn, improper tire inflation pressure, etc.)
  - When the vehicle is being driven on a gravel road or other slippery surface

**■ If the PCS warning light flashes and a warning message is displayed on the multi-information display**

The pre-crash safety system may be temporarily unavailable or there may be a malfunction in the system.

● In the following situations, the warning light will turn off, the message will disappear and the system will become operational when normal operating conditions return:

- When the area around the front sensor is hot, such as in the sun
- When the windshield is fogged up or covered with condensation or ice (→P. 394, 403)
- When the front sensor or the area around either sensor is cold, such as in an extremely cold environment
- If the area in front of the front sensor is obstructed, such as when the hood is open

● If the PCS warning light continues to flash or the warning message does not disappear, the system may be malfunctioning. Have the vehicle inspected by any authorized Toyota dealer or repairer, or another duly qualified and equipped professional immediately.

**■ If VSC is disabled**

● If TRC and VSC are disabled (→P. 316), the pre-crash brake assist and pre-crash braking functions are also disabled. However, the pre-crash warning function will still operate.

● The PCS warning light illuminates and “Pre-Crash Brake is disabled due to VSC OFF.” is displayed on the multi-information display.

تلفن شبانه روزی: ۰۲۱-۸۸۶۲۰۸۵

FarmaSOS.com

## LDA (Lane Departure Alert)\*

### Summary of function

When driving on roads with white (yellow) lines, this function alerts the driver when the vehicle might depart from its lane.

The LDA system recognizes visible white (yellow) lines with the front sensor on the upper portion of the windshield.

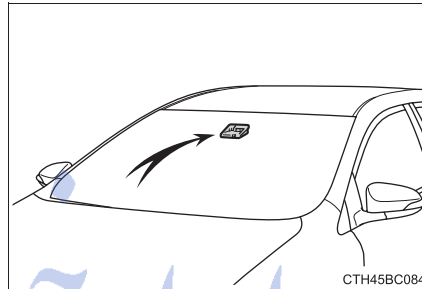

### Lane departure alert function

When the system determines that the vehicle might depart from its lane, a warning is displayed on the multi-information display and the warning buzzer sounds to alert the driver.

When the warning buzzer sounds, check the surrounding road situation and carefully operate the steering wheel to move the vehicle back to the center within the white (yellow) lines.

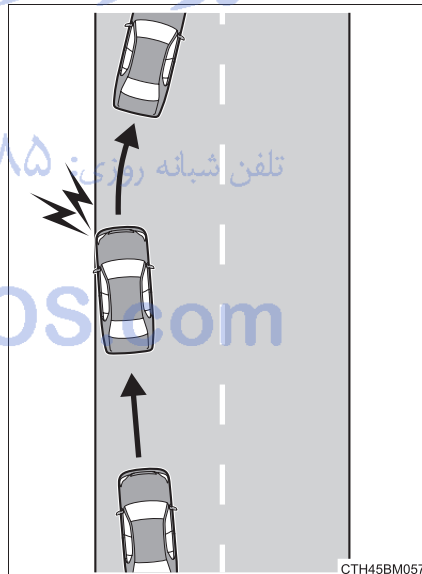

4

Driving

\*: If equipped

 **WARNING****■ Before using the LDA system**

Do not rely solely upon the LDA system. LDA is not a system which automatically drives the vehicle or reduces the amount of attention that must be paid to the area in front of the vehicle. The driver must always assume full responsibility for driving safely by always paying careful attention to the surrounding conditions and operate the steering wheel to correct the path of the vehicle. Also, make sure to take adequate breaks when fatigued, such as from driving for a long period of time.

Failure to perform appropriate driving operations and pay careful attention may lead to an accident, resulting in death or serious injury.

**■ To avoid operating the LDA by mistake**

When not using the LDA system, use the LDA switch to turn the system off.

**■ Preventing LDA system malfunctions and operations performed by mistake**

- Do not modify the headlights or place stickers, etc., on the surface of the lights.
- Do not modify the suspension etc. If the suspension etc. needs to be replaced, contact any authorized Toyota dealer or repairer, or another duly qualified and equipped professional.
- Do not install or place anything on the hood or grille. Also, do not install a grille guard (bull bars, kangaroo bar, etc.).
- If your windshield needs repairs, contact any authorized Toyota dealer or repairer, or another duly qualified and equipped professional.

FarmaSOS.com



### Turning the LDA system on

Press the LDA switch to turn the LDA system on.

The LDA indicator illuminates and a message is displayed on the multi-information display.

Press the LDA switch again to turn the LDA system off.

When the LDA system is turned on or off, operation of the LDA system continues in the same condition the next time the engine is started

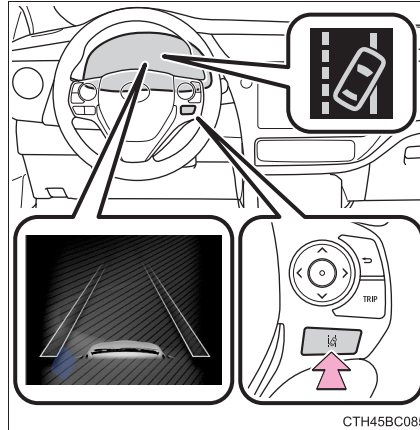

CTH45BC085

### Indication on the multi-information display

- ▶ Inside of displayed white lines is white
- ▶ Inside of displayed white lines is black



CTH45BC087

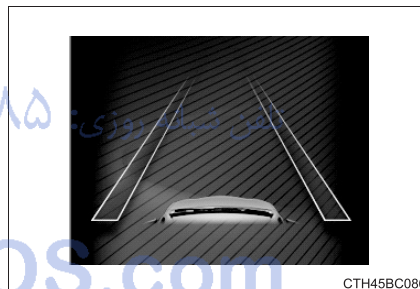

CTH45BC086

Indicates that the system is recognizing white (yellow) lines. When the vehicle departs from its lane, the white line displayed on the side the vehicle departs from flashes orange.

Indicates that the system is not able to recognize white (yellow) lines or is temporarily canceled.

**■ If “Check LDA system.” is displayed on the multi-information display**

If the LDA indicator does not come on when the LDA switch is pressed to turn the system on, the system may be malfunctioning. Have the vehicle inspected by any authorized Toyota dealer or repairer, or another duly qualified and equipped professional immediately.

**■ Operation conditions**

This function operates when all of the following conditions are met.

- LDA is turned on.
- Vehicle speed is approximately 50 km/h (32 mph) or more.
- System recognizes white (yellow) lines.
- Width of traffic lane is approximately 3 m (9.8 ft.) or more.
- Turn signal lever is not operated.
- Vehicle is driven on a straight road or around a gentle curve with a radius of more than approximately 150 m (492 ft.).
- No system malfunctions are detected. (→P. 513)

**■ Temporary cancellation of functions**

When operation conditions are no longer met, a function may be temporarily canceled. However, when the operation conditions are met again, operation of the function is automatically restored.

**■ Lane departure alert function**

The warning buzzer may be difficult to hear due to external noise, audio playback, etc.

**■ White (yellow) lines are only on one side of road**

The LDA system will not operate for the side on which white (yellow) lines could not be recognized.

**■ After the vehicle has been parked in the sun**

The LDA system may not be available and a warning message may be displayed for a while after starting off. When the temperature in the cabin decreases and the temperature around the front sensor (→P. 241) becomes suitable for its operation, the system will begin to operate.

**■ If there are lane markers on only one side of the vehicle**

The lane departure warning will not operate for the side on which lane markers could not be recognized.

#### ■ Conditions in which functions may not operate properly

In the following situations, the front sensor may not detect white (yellow) lines and various functions may not operate normally.

- There are shadows on the road that run parallel with, or cover, the white (yellow) lines.
- The vehicle is driven in an area without white (yellow) lines, such as in front of a tollgate or checkpoint, or at an intersection, etc.
- The white (yellow) lines are cracked, or cat's eyes (reflective markers) or stones are present.
- The white (yellow) lines cannot be seen or are difficult to see due to sand, etc.
- The vehicle is driven on a road surface that is wet due to rain, puddles, etc.
- The traffic lines are yellow (which may be more difficult to recognize than lines that are white).
- The white (yellow) lines cross over a curb, etc.
- The vehicle is driven on a bright surface, such as concrete.
- The vehicle is driven on a surface that is bright due to reflected light, etc.
- The vehicle is driven in an area where the brightness changes suddenly, such as at the entrances and exits of tunnels, etc.
- Light from the headlights of an oncoming vehicle, the sun, etc., enters the camera.
- The vehicle is driven where the road diverges, merges, etc.
- The vehicle is driven on a slope.
- The vehicle is driven on a road which tilts left or right, or a winding road.
- The vehicle is driven on an unpaved or rough road.
- The vehicle is driven around a sharp curve.
- The traffic lane is excessively narrow or wide.
- The vehicle is extremely tilted due to carrying heavy luggage or having improper tire pressure.
- The distance to the preceding vehicle is extremely short.
- The vehicle is moving up and down a large amount due to road conditions during driving (poor roads or road seams).
- The headlight lenses are dirty and emit a faint amount of light at night, or the beam axis has deviated.
- The vehicle has just changed lanes or crossed an intersection.

#### ■ Warning messages for the LDA system

Warning messages are used to indicate a system malfunction or to inform the driver of the need for caution while driving.

#### ■ Customization

→P. 611

## Automatic High Beam\*

The Automatic High Beam uses an in-vehicle front sensor to assess the brightness of streetlights, the lights of vehicles ahead etc., and automatically turns the high beam on or off as necessary.

### WARNING

#### ■ Limitations of the Automatic High Beam

Do not rely on the Automatic High Beam. Always drive safely, taking care to observe your surroundings and turning the high beam on or off manually if necessary.

#### ■ To prevent incorrect operation of the Automatic High Beam system

Do not overload the vehicle.

### Activating the Automatic High Beam system

Push the lever away from you with the headlight switch in **AUTO** position.

The Automatic High Beam indicator will come on when the headlights are turned on automatically to indicate that the system is active.

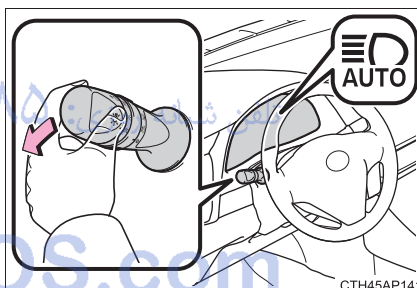

\*: If equipped

### Turning the high beam on/off manually

#### ■ Switching to low beam

Pull the lever to original position.

The Automatic High Beam indicator will turn off.

Push the lever away from you to activate the Automatic High Beam system again.

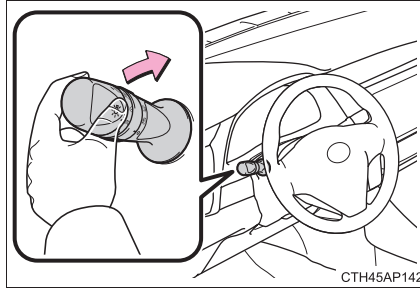

#### ■ Switching to high beam

Turn the light switch to  position.

The Automatic High Beam indicator will turn off and the high beam indicator will turn on.

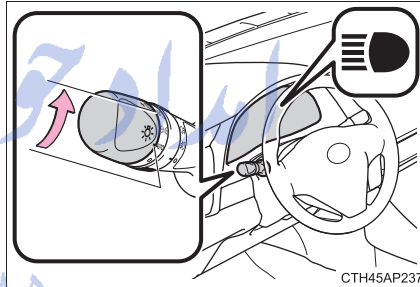

تلفن شبانه روزی: ۰۲۱-۸۸۶۲۰۸۵

FarmaSOS.com

**■ High beam automatic turning on or off conditions**

- When all of the following conditions are fulfilled, the high beam will be automatically turned on (after approximately 1 second):
  - Vehicle speed is approximately 40 km/h (25 mph) or more.
  - The area ahead of the vehicle is dark.
  - There are no vehicles ahead with headlights or tail lights turned on.
  - There are few streetlights on the road ahead.
- If any of the following conditions is met, the high beams will turn off automatically:
  - Vehicle speed is below approximately 30 km/h (19 mph).
  - The area ahead of the vehicle is not dark.
  - Vehicles ahead have their headlights or tail lights turned on.
  - There are many streetlights on the road ahead.

**■ Front sensor detection information**

- The high beam may not be automatically turned off in the following situations:
  - When vehicles ahead suddenly appear from a curve
  - When the vehicle is cut in front of by another vehicle
  - When vehicles ahead are hidden from sight due to repeated curves, road dividers or roadside trees
  - When vehicles ahead appear from the faraway lane on wide road
  - When vehicles ahead have no lights
- The high beam may be turned off if a vehicle ahead that is using fog lights without using the headlights is detected.
- House lights, street lights, traffic signals, and illuminated billboards or signs may cause the high beam to switch to the low beams, or the low beams to remain on.
- The following factors may affect the amount of time taken to turn the high beam on or off:
  - The brightness of headlights, fog lights, and tail lights of vehicles ahead
  - The movement and direction of vehicles ahead
  - When a vehicle ahead only has operational lights on one side
  - When a vehicle ahead is a two-wheeled vehicle
  - The condition of the road (gradient, curve, condition of the road surface, etc.)
  - The number of passengers and amount of luggage
- The high beam may be turned on or off when the driver does not expect it.
- Bicycles or similar objects may not be detected.

- In the situations shown below, the system may not be able to accurately detect surrounding brightness levels. This may cause the low beams to remain on or the high beams to cause problems for pedestrians, vehicles ahead or other parties. In these cases, manually switch between the high and low beams.
  - In bad weather (rain, snow, fog, sandstorms, etc.)
  - The windshield is obscured by fog, mist, ice, dirt, etc.
  - The windshield is cracked or damaged.
  - The front sensor is deformed or dirty.
  - The front sensor temperature is extremely high.
  - Surrounding brightness levels are equal to those of headlights, tail lights or fog lights.
  - Vehicles ahead have headlights or tail lights that are either switched off, dirty, are changing color, or are not aimed properly.
  - When driving through an area of intermittently changing brightness and darkness.
  - When frequently and repeatedly driving ascending/descending roads, or roads with rough, bumpy or uneven surfaces (such as stone-paved roads, gravel tracks, etc.).
  - When frequently and repeatedly taking curves or driving on a winding road.
  - There is a highly reflective object ahead of the vehicle, such as a sign or a mirror.
  - The back of a vehicle ahead is highly reflective, such as a container on a truck.
  - The vehicle's headlights are damaged or dirty, or are not aimed properly.
  - The vehicle is listing or tilting due to a flat tire, a trailer being towed, etc.
  - The high beam and low beam are repeatedly being switched between in an abnormal manner.
  - The driver believes that the high beam may be causing problems or distress to other drivers or pedestrians nearby.

## RSA (Road Sign Assist)\*

### Summary of function

RSA recognizes specific road signs using the front sensor and provides information to the driver via the multi-information display.

If the system judges that the vehicle is being driven over the speed limit, performing prohibited actions, etc., in relation to the recognized road signs, it alerts the driver using a warning display and warning buzzer\*.

\*: This setting needs to be customized.

Front sensor

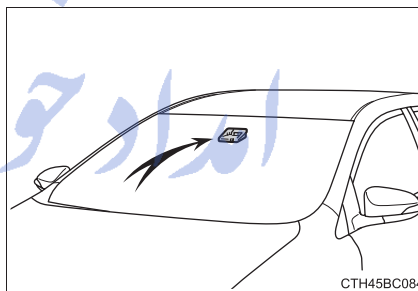

تلفن شبانه روزی: ۰۲۱-۸۸۸۶۲۰۸۵

FarmaSOS.com

\*: If equipped



### Indication on the multi-information display

After the front sensor recognizes a sign, it is displayed on the multi-information display when the vehicle passes the sign.

- When the driving assist system information is selected, a maximum of 3 signs can be displayed. (→P. 101)

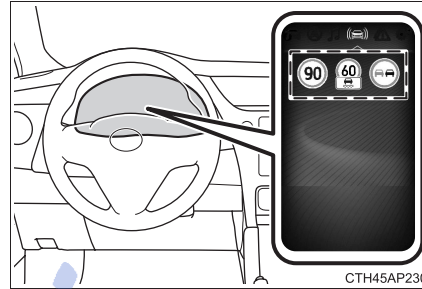

- When other than the driving assist system information is selected, a speed limit sign or an all canceled sign can be displayed. (→P. 101)

A no overtaking sign and a speed limit sign with supplemental mark are not displayed. However, if signs other than speed limit signs are recognized, they are mentioned in a stack under the current speed limit sign.

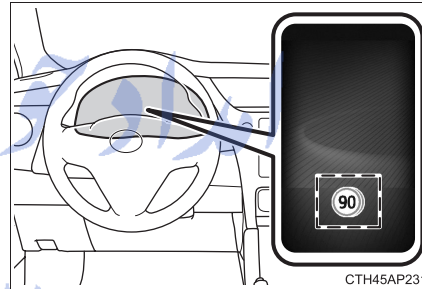

4







Driving

FarmaSOS.com

**Types of recognized road signs**

The following types of road signs, including electronic signs and blinking signs, are recognized.

A non-official (not meeting the Vienna Convention) or a recently introduced traffic sign may not be recognized.

Type		Multi-information display
Speed limit begins/ends*1		
Speed limit with supplemental mark (Displayed simultaneously with speed limit)	Rain	
	Ice	
	On/off ramp*2	
(Display example)	Supplemental mark exists (Contents not recognized)	
No overtaking begins/ends		
All canceled (All restrictions canceled. Returns to default road regulation.)		

\*1: A speed limit sign with a value greater than 130 km/h may not be recognized and a wrong speed limit may be displayed.

\*2: If the turn signal indicator is not operated when changing lanes, the mark does not display.

**Warning display**

In the following situations, the RSA system alerts the driver using a warning display.

- When the vehicle speed exceeds the speed warning threshold applied to the speed limit of the sign displayed on the multi-information display, the sign color becomes inverted.
- If it is detected that your vehicle is overtaking when a no overtaking sign is displayed on the multi-information display, the sign flashes.

Depending on the situation, traffic environment (traffic direction, speed, unit) may be detected incorrectly and a warning display may not operate properly.

**Automatic turn-off of RSA sign display**

One or more signs automatically turn off in the following situations.

- A new sign is not recognized for a certain distance.
- The road changes due to a left or right turn, etc.  
Depending on the situation, the driving behavior (turning, lane change, etc.) may be detected incorrectly and the automatic turn-off may not operate properly.

تلفن شبانه روزی: ۰۲۱-۸۸۶۲۰۸۵

FarmaSOS.com

**■ Conditions in which the function may not operate or detect correctly**

In the following situations, RSA does not operate normally and may not recognize signs, display the incorrect sign, etc. However, this does not indicate a malfunction.

- The front sensor is misaligned due to a strong impact being applied to the sensor, etc.
- Dirt, snow, stickers, etc., are on the windshield near the front sensor.
- In inclement weather such as heavy rain, fog, snow or sand storms
- Light from an oncoming vehicle, the sun, etc., enters the front sensor.
- The sign is small, dirty, faded, tilted or bent, and if an electronic sign, the contrast is poor.
- All or part of the sign is hidden by the leaves of a tree, a pole, etc.
- The sign is only visible to the front sensor for a short amount of time.
- The driving scene (turning, lane change, etc.) is judged incorrectly.
- Even if it is a sign not appropriate for the currently traveled lane, such a sign exists directly after a freeway branches, or in an adjacent lane just before merging.
- Stickers are attached to the rear of the preceding vehicle.
- A sign resembling a system compatible sign is recognized.
- The vehicle is driven in a country with a different direction of traffic.
- Side road speed signs may be detected and displayed (if positioned in sight of the front sensor) while the vehicle is traveling on the main road.
- Roundabout exit road speed signs may be detected and displayed (if positioned in sight of the front sensor) while traveling on a roundabout.
- The speed information displayed on the meter and that displayed on the Navigation system (if equipped) may be different due to the Navigation system using map data.

#### ■ When driving vehicle in country with different speed unit

Since RSA recognizes signs based on the set unit of the meter, it is necessary to change the set unit of the meter. Adjust the set unit of the meter to the speed unit of signs in the current location. (→P. 611)

#### ■ Turning the system on/off

- 1 Select  on the settings display (→P. 107)
- 2 Press the enter/set switch on the meter control switches.



#### ■ Speed limit sign display

If the engine switch was last turned off while a speed limit sign was displayed on the multi-information display, the same sign displays again when the engine switch is turned to "ON" position (vehicles without smart entry & start system) or IGNITION ON mode (vehicles with smart entry & start system).

#### ■ When "Check RSA system." is displayed on the multi-information display

The system may be malfunctioning. Have the vehicle inspected by any authorized Toyota dealer or repairer, or another duly qualified and equipped professional immediately.

#### ■ Customization

The settings for warning display, warning buzzer\*, speeding warning threshold, etc., can be changed. (Customizable feature: →P. 611)

\*: If a speed limit with supplemental mark is exceeded, the warning buzzer does not operate.

#### ⚠ WARNING

##### ■ Before using the RSA

Do not rely solely upon the RSA system. RSA is a system which supports the driver by providing information, but it is not a replacement for a driver's own vision and awareness. Drive safely by always paying careful attention to the traffic rules.

Inappropriate or negligent driving could lead to an unexpected accident.

## Stop & Start system\*

The Stop & Start system stops and restarts the engine according to the clutch pedal operation when the vehicle is stopped.

### Stop & Start system operation

#### ■ Stopping the engine

- 1 With the clutch pedal fully depressed, depress the brake pedal, and stop the vehicle.
- 2 Shift the shift lever to N (→P. 209), and release the clutch pedal.  
The Stop & Start indicator will come on.

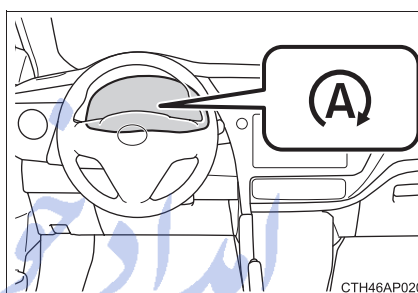

#### ■ Restarting the engine

Check that the shift lever is in N and depress the clutch pedal.

The Stop & Start indicator will turn off.

FarmaSOS.com

\*: If equipped

### Disabling the Stop & Start system

Press the Stop & Start cancel switch to disable the Stop & Start system.

The Stop & Start cancel indicator will come on.

Pressing the switch again will enable the Stop & Start system and the Stop & Start cancel indicator will turn off.

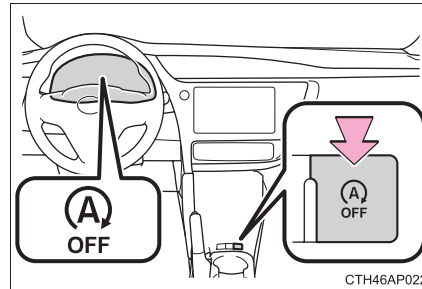

### Automatic reactivation of the Stop & Start system

#### ▶ Vehicles without a smart entry & start system

Even if the Stop & Start system is disabled by the Stop & Start cancel switch, it will be automatically re-enabled once the engine switch is turned to the "LOCK" position then to the "START" position.



#### ▶ Vehicles with a smart entry & start system

Even if the Stop & Start system is disabled by the Stop & Start cancel switch, it will be automatically re-enabled once the engine switch is turned off, and then the engine is started.

### ■ If the Stop & Start cancel switch is pressed while the vehicle is stopped

- When the engine is stopped by the Stop & Start system, pressing the Stop & Start cancel switch will restart the engine. From the next time the vehicle is stopped (after Stop & Start system has been turned off), the engine will not be stopped.
- With the Stop & Start system disabled, pressing the Stop & Start cancel switch will re-enable the system but not stop the engine. From the next time the vehicle is stopped (after Stop & Start system has been turned on), the engine will be stopped.

**■ Operating conditions**

- The Stop & Start system is operational when all of the following conditions are met:
  - Vehicles with an automatic air conditioning system:  is off.
  - The driver's seat belt is fastened.
  - The engine is adequately warmed up.
  - The driver's door is closed.
  - The clutch pedal is not being depressed.
  - The outside temperature is  $-5^{\circ}\text{C}$  ( $23^{\circ}\text{F}$ ) or higher.
  - The shift lever is in N.
  - The hood is closed.
- In the following situations the engine may not be stopped by the Stop & Start system. This is not a malfunction of the Stop & Start system.
  - The air conditioning system is being used when the ambient temperature is high or low.
  - The battery is not sufficiently charged, such as if the vehicle has been parked for a long time and the battery charge has decreased, the electric load is large, the battery temperature is excessively low or the battery has deteriorated, or is undergoing a periodic recharge.
  - The brake booster vacuum is low.
  - The steering wheel is being operated.
  - Due to traffic or other circumstances the vehicle is stopped repeatedly.
  - The vehicle is being driven in a high altitude area.
  - Engine coolant temperature or transmission fluid temperature is extremely low or high.
  - The battery fluid temperature is extremely low or high.
  - For a while after the battery terminals have been disconnected and reconnected.
  - For a while after the battery replacement.
  - Vehicles with a power heater: The power heater is being used.
- In the following situations, the engine will restart automatically if the engine is stopped by the Stop & Start system. (To enable stopping of the engine by the Stop & Start system, drive the vehicle.)
  - The air conditioning system is turned on.
  - Vehicles with an automatic air conditioning system:  is turned on.
  - The steering wheel is operated.
  - The driver's seat belt is unfastened.
  - The driver's door is opened.
  - The Stop & Start cancel switch is pressed.
  - The vehicle starts to roll on an incline.
  - Vehicles with a power heater: The power heater is turned on.



- In the following situations, the engine may restart automatically if the engine is stopped by the Stop & Start system. (To enable stopping of the engine by the Stop & Start system, drive the vehicle.)
  - The brake pedal is pumped or strongly depressed.
  - The air conditioning system is being used.
  - The battery is not sufficiently charged.

#### ■ Hood

- If the hood is opened while the engine is stopped by the Stop & Start system, the engine will stall and will not be able to be restarted by the automatic engine start function. In this case, restart the engine using the normal engine starting procedure. (→P. 196, 199)
- Even if the hood is closed after the engine is started with the hood open, the Stop & Start system will not operate. Close the hood, turn the engine switch off, wait 30 seconds or more, and then start the engine.

#### ■ When to use the Stop & Start system

- If the engine is stopped by the Stop & Start system and the shift lever is shifted into a position other than N with the clutch pedal released, a buzzer will sound and Stop & Start indicator will flash. This indicates that the engine is only stopped by the Stop & Start system, not that the engine has been turned off completely.
- Use the Stop & Start system when stopping the vehicle temporarily at red lights, intersections, etc. When stopping the vehicle for a longer period of time, stop the engine completely.
- When the system does not operate, is canceled, or is malfunctioning, warning messages (vehicles with a multi-information display only) and a warning buzzer are used to inform the driver. (→P. 281)
- Vehicles with a smart entry & start system: If the engine switch is pressed when the engine is stopped by the Stop & Start system, the engine will stall and will not be able to be restarted by the automatic engine start function. In this case, restart the engine using the normal engine starting procedure. (→P. 196, 199)
- When the engine is restarted by the Stop & Start system, the power outlet may be temporarily unusable, but this is not a malfunction.
- Installation and removal of electrical components and wireless devices may affect the Stop & Start system. Contact any authorized Toyota retailers or Toyota authorized repairers, or any reliable repairers for details.

■ **If the windshield is fogged up while the engine is stopped by the Stop & Start system**

- Vehicles with a manual air conditioning system: Restart the engine by depressing the clutch pedal or by pressing the Stop & Start cancel switch, and then set the air outlet selector dial to . (→P.394)

If the windshield fogs up frequently, press the Stop & Start cancel switch to deactivate the system.

- Vehicles with an automatic air conditioning system: Turn  on. (The engine will start due to the automatic engine start function.) (→P.403)

If the windshield fogs up frequently, press the Stop & Start cancel switch to disable the system.

■ **If an odor comes from the air conditioning system while the engine is stopped by the Stop & Start system**

Vehicles with a manual air conditioning system: If the idling stop time is set to extended, change the setting to standard. If an odor occurs even when the standard setting is selected, press the Stop & Start cancel switch to deactivate the Stop & Start system.

Vehicles with an automatic air conditioning system: Press the Stop & Start cancel switch to deactivate the Stop & Start system.

■ **Air conditioning system operation while the engine is stopped by the Stop & Start system**

- Vehicles with an automatic air conditioning system: If the air conditioning system is being used in automatic mode and the engine is stopped by the Stop & Start system, the air conditioning system may decrease the fan speed or stop blowing air. The purpose of this is to reduce the increase in temperature while cooling or the decrease in temperature while heating.

- In order to enhance the efficiency of the air conditioning system, disable the Stop & Start system by pressing the Stop & Start cancel switch.

### ■ Changing the idling stop time with the air conditioning system on

The length of time the Stop & Start system will operate when the air conditioning system is on can be changed by performing the following operation. (The length of time the Stop & Start system will operate when the air conditioning system is off cannot be changed.)

#### ▶ Vehicles with a drive monitor display

##### ● Setting by pressing and holding the Stop & Start cancel switch

Each time the Stop & Start cancel switch is pressed and held for 3 seconds or more, the length of the operation time will be changed. The current setting will be displayed on the multi-information display.

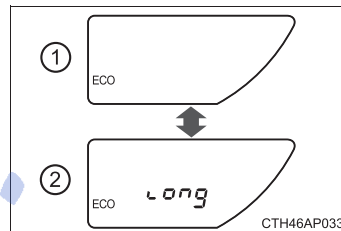

① Standard

② Extended

#### ▶ Vehicles with a multi-information display

##### ● Setting by pressing and holding the Stop & Start cancel switch

Each time the Stop & Start cancel switch is pressed and held for 3 seconds or more, the system switches between standard and extended. The system status can be confirmed on the multi-information display  (Settings display) screen. (→P. 107)

- Settings from the  (Settings display) screen of the multi-information display  
→P. 107

■ **The Stop & Start system protection function**

- Vehicles without a smart entry & start system: When an excessively loud sound is being projected by the audio system, the audio system may be automatically cut off in order to reduce battery consumption. If it occurs, turn the engine switch off, wait for 3 seconds or longer and then turn it to “ACC” or “ON” position to re-enable the audio system.
- Vehicles with a smart entry & start system: When an excessively loud sound is being projected by the audio system, the audio system may be automatically cut off in order to reduce battery consumption. If it occurs, turn the engine switch off, wait for 3 seconds or longer and then turn it to ACCESSORY mode or IGNITION ON mode to re-enable the audio system.
- The audio system may not be activated when the battery terminals are disconnected and then reconnected. If it occurs, turn the engine switch off and then repeat the following operation twice to activate the audio system normally.
  - Vehicles without a smart entry & start system: Turn the engine switch to “ON” position and then to OFF.
  - Vehicles with a smart entry & start system: Turn the engine switch to IGNITION ON mode and then to OFF.

■ **Replacing the battery**

→P. 582

■ **Displaying the Stop & Start system status**

→P. 105



تلفن شبانه روزی: ۰۲۱-۸۸۶۲۰۸۵

FarmaSOS.com

### ■ Multi-information display messages (vehicles with a multi-information display)



If the following situations,  and a message may be displayed on the multi-information display.

- When the engine cannot be stopped by the Stop & Start system

Message	Details
 "Depress brake firmly to activate."	<p><b>The brake pedal is not depressed enough.</b> If the brake pedal is depressed further, the system will operate.</p>
 "For climate control."	<ul style="list-style-type: none"> <li>• <b>The air conditioning system is being used when the ambient temperature is high or low.</b> If the difference between the set temperature and cabin temperature is small, the system will be enabled.</li> <li>•  is ON. (Vehicles with an automatic air conditioning system)</li> </ul>







تلفن شبانه روزی: ۰۲۱-۸۸۶۲۰۸۵

FarmaSOS.com

Message	Details
 <p>“Battery charging.”</p>	<ul style="list-style-type: none"> <li>• <b>The battery charge amount may be low.</b> Engine stop is temporarily prohibited to prioritize charging of the battery, but if the engine is operated for a short while, engine stop is allowed.</li> <li>• <b>A refresh charge may be occurring, such as when the battery is undergoing a periodic recharge, for a while after the battery terminals have been disconnected and reconnected, for a while after the battery has been replaced, etc.</b> After a refresh charge of approximately 5 to 60 minutes completes, the system can be operated.</li> <li>• <b>The engine may have been started with the hood opened.</b> Close the hood, turn the engine switch off, wait 30 seconds or more, and then start the engine.</li> <li>• <b>The battery may be cold.</b> Operating the engine for a short while allows the system to recover due to the temperature increase in the engine compartment.</li> <li>• <b>The battery may be extremely hot.</b> If the engine compartment is allowed to cool sufficiently, the system recovers.</li> <li>● If the message is displayed continuously, the battery may have deteriorated. Contact any authorized Toyota retailers or Toyota authorized repairers, or any reliable repairers.</li> </ul>
 <p>“For brake system.”</p>	<ul style="list-style-type: none"> <li>• <b>The vehicle is being driven in a high altitude area.</b></li> <li>• <b>The brake booster vacuum is low.</b> When the brake booster vacuum reaches a predetermined level, the system will be enabled.</li> </ul>
 <p>“Bonnet open.”</p>	<p><b>The engine has been started with the hood opened.</b> To enable the system, close the hood, turn the engine switch off, wait for a short while, and then start the engine.</p>

Message	Details
 "Driver seat belt unbuckled."	<b>The driver seat belt is not fastened.</b>

- When the engine automatically restarts while stopped by the Stop & Start system

Message	Details
 "For climate control."	<ul style="list-style-type: none"> <li>• <b>The air conditioning system has been turned on or is being used.</b></li> <li>•  <b>has been turned on. (Vehicles with an automatic air conditioning system)</b></li> </ul>
 "For brake system."	<b>The brake pedal has been depressed further or pumped.</b> The system will be enabled after the engine runs and the brake booster vacuum reaches a predetermined level.
 "Battery charging."	<b>The battery charge amount may be low.</b> The engine is restarted to prioritize battery charging. Operating the engine for a short while allows the system to recover.
 "Steering wheel turned."	<b>The steering wheel was operated.</b>
 "Bonnet open."	<b>The hood has been opened.</b>
 "Driver seat belt unbuckled."	<b>The driver seat belt has been unfastened.</b>

- When the engine cannot be restarted by the Stop & Start system

Message	Details
 "Stop & Start system active. Shift to N and depress clutch to restart."	<b>The shift lever has been shifted from N to another position with the clutch pedal released.</b> To restart the engine, shift the shift lever to N and then depress the clutch pedal.

■ **If “Stop & Start system malfunction. Inspect at dealer.” is displayed on the multi-information display (vehicles with a multi-information display)**

The system may be malfunctioning. Have the vehicle inspected by any authorized Toyota retailers or Toyota authorized repairers, or any reliable repairers.

■ **If the Stop & Start cancel indicator continues to flash**

The system may be malfunctioning. Have the vehicle inspected by any authorized Toyota retailers or Toyota authorized repairers, or any reliable repairers.

 **WARNING**

■ **When the Stop & Start system is operating**

- Keep the shift lever in N and depress the brake pedal or apply the parking brake while the engine is stopped by the Stop & Start system (while the Stop & Start indicator is on).
- Do not allow anyone to leave the vehicle while the engine is stopped by the Stop & Start system (while the Stop & Start indicator is on). An accident may occur due to the automatic engine start function.
- Ensure that the engine is not stopped by the Stop & Start system while the vehicle is in a poorly ventilated area. The engine may restart due to the automatic engine start function, causing exhaust gases to collect and enter the vehicle, possibly resulting in death or a serious health hazard.

تلفن شبانه روزی: ۰۲۱-۸۸۶۲۰۸۵

FarmaSOS.com



 NOTICE**■ To ensure the system operates correctly**

If any of the following situations occur, the Stop & Start system may not operate correctly. Have your vehicle checked by any authorized Toyota retailers or Toyota authorized repairers, or any reliable repairers.

- While the driver's seat belt is fastened, the driver's and front passenger's seat belt reminder light flashes.
- Even though the driver's seat belt is not fastened, the driver's and front passenger's seat belt reminder light does not illuminate.
- Vehicles with a drive monitor display: Even though the driver's door is closed, the open door warning light is illuminated or the interior light is illuminated when the interior light switch is in the door position.
- Vehicles with a multi-information display: Even though the driver's door is closed, the open door warning is displayed on the multi-information display or the interior light is illuminated when the interior light switch is in the door position.
- Vehicles with a drive monitor display: Even though the driver's door is open, the open door warning light does not illuminate or the interior light does not illuminate when the interior light switch is in the door position.
- Vehicles with a multi-information display: Even though the driver's door is open, the open door warning is not displayed on the multi-information display or the interior light does not illuminate when the interior light switch is in the door position.

FarmaSOS.com

## Cruise control\*

### Summary of functions

Use the cruise control to maintain a set speed without depressing the accelerator pedal.

- ① Indicators
- ② Cruise control switch

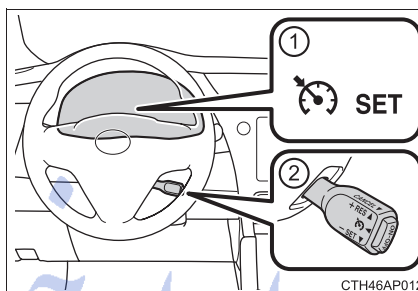

### Setting the vehicle speed

- 1 Press the "ON-OFF" button to activate the cruise control.  
Cruise control indicator will come on.  
Press the button again to deactivate the cruise control.



- 2 Accelerate or decelerate the vehicle to the desired speed, and push the lever down to set the speed.  
"SET" indicator will come on.  
The vehicle speed at the moment the lever is released becomes the set speed.

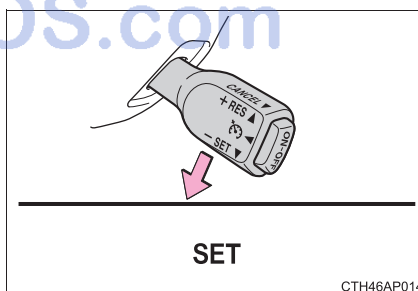

\*: If equipped

### Adjusting the set speed

To change the set speed, operate the lever until the desired set speed is obtained.

- ① Increases the speed
- ② Decreases the speed

Fine adjustment: Momentarily move the lever in the desired direction.

Large adjustment: Hold the lever in the desired direction.

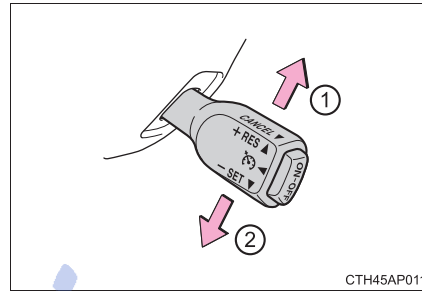

CTH45AP011

The set speed will be increased or decreased as follows:

Fine adjustment: By approximately 1.6 km/h (1 mph) each time the lever is operated.

Large adjustment: The set speed can be increased or decreased continually until the lever is released.

### Canceling and resuming the constant speed control

- ① Pulling the lever toward you cancels the constant speed control.

The speed setting is also canceled when the brakes are applied or the clutch pedal (manual transmission) is depressed.

- ② Pushing the lever up resumes the constant speed control.

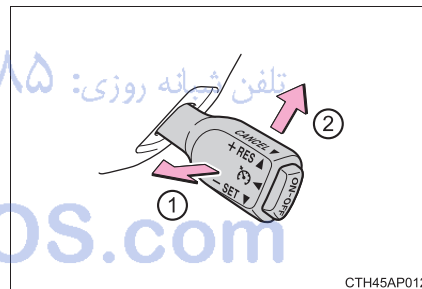

CTH45AP012

Resuming is available when the vehicle speed is more than approximately 40 km/h (25 mph).

■ **Cruise control can be set when**

- The shift lever is in the D or gear step 4 or higher of M has been selected. (Multidrive)
- Vehicle speed is above approximately 40 km/h (25 mph).

■ **Accelerating after setting the vehicle speed**

- The vehicle can be accelerated normally. After acceleration, the set speed resumes.
- Even without canceling the cruise control, the set speed can be increased by first accelerating the vehicle to the desired speed and then pushing the lever down to set the new speed.

■ **Automatic cruise control cancelation**

Cruise control will stop maintaining the vehicle speed in any of the following situations.

- Actual vehicle speed falls more than approximately 16 km/h (10 mph) below the preset vehicle speed.  
At this time, the memorized set speed is not retained.
- Actual vehicle speed is below approximately 40 km/h (25 mph).
- VSC is activated.
- Speed limiter is activated. (if equipped)

■ **If the cruise control indicator light comes on in yellow (vehicles with a drive monitor display) or “Check cruise control system.” is displayed on the multi-information display (vehicles with a multi-information display)**

Press the “ON-OFF” button once to deactivate the system, and then press the button again to reactivate the system.

If the cruise control speed cannot be set or if the cruise control cancels immediately after being activated, there may be a malfunction in the cruise control system. Have the vehicle inspected by any authorized Toyota dealer or repairer, or another duly qualified and equipped professional.

 WARNING**■ To avoid operating the cruise control by mistake**

Switch the cruise control off using the “ON-OFF” button when not in use.

**■ Situations unsuitable for cruise control**

Do not use cruise control in any of the following situations.

Doing so may result in loss of control and could cause an accident resulting in death or serious injury.

- In heavy traffic
- On roads with sharp bends
- On winding roads
- On slippery roads, such as those covered with rain, ice or snow
- On steep hills  
Vehicle speed may exceed the set speed when driving down a steep hill.
- When your vehicle is towing a trailer or during emergency towing

تلفن شبانه روزی: ۰۲۱-۸۸۶۲۰۸۵

FarmaSOS.com

## Speed limiter\*

### Summary of functions

A desired maximum speed can be set using the cruise control switch. The speed limiter prevents vehicle speed from exceeding the set speed.

- ▶ Vehicles with a drive monitor display
- ▶ Vehicles with a multi-information display

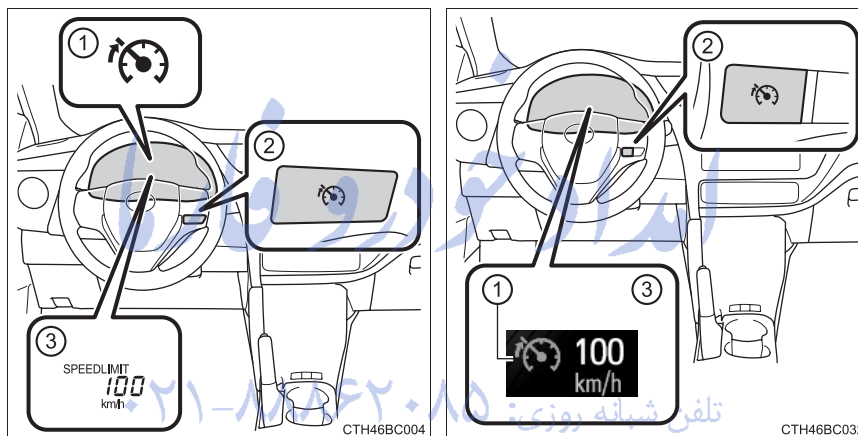

- ① Indicator
- ② Speed limiter switch
- ③ Display

\*: If equipped

### Setting the vehicle speed

- 1 Turn the speed limiter switch on.

Press the switch once more to deactivate the speed limiter.

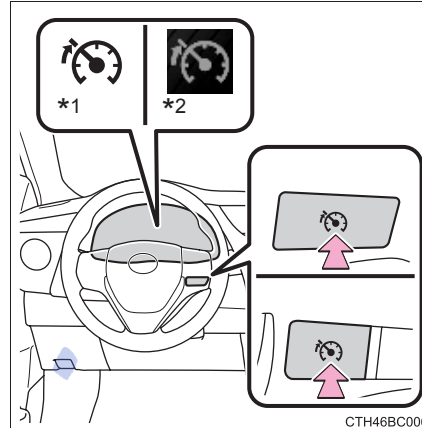

- 2 Accelerate or decelerate to the desired speed and push the lever down to set the desired maximum speed.

If the lever is pushed down while the vehicle speed is below 30 km/h (20 mph), the set speed will be 30 km/h (20 mph).

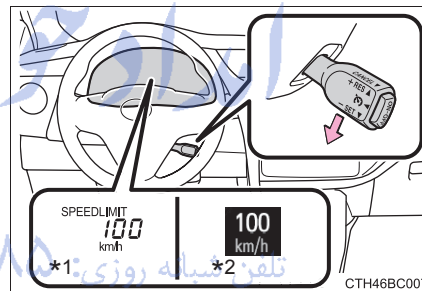

\*1: Vehicles with a drive monitor display

\*2: Vehicles with a multi-information display

### Adjusting the speed setting

- 1 Increase the speed
- 2 Decrease the speed

Hold the lever until the desired speed setting is obtained.

Fine adjustment of the set speed can be made by lightly pushing the lever up or down and releasing it.

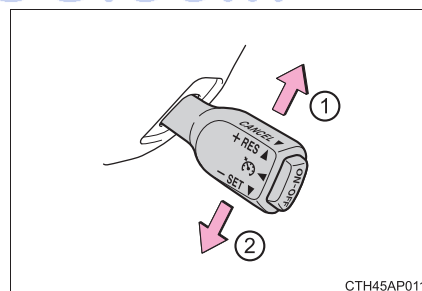

### Canceling and resuming the speed limiter

- ① **Cancel**  
Pull the lever towards you to cancel the speed limiter.
- ② **Resume**  
To resume use of the speed limiter, push the lever up.

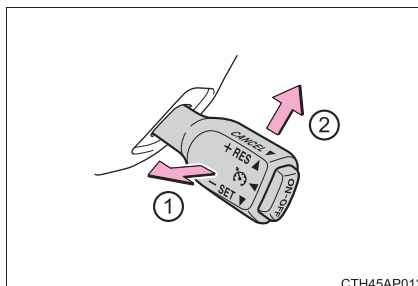

CTH45AP012

#### ■ Exceeding the set speed

In the following situations, the vehicle speed exceeds the set speed and display characters will flash:

- When fully depressing the accelerator pedal
- When driving down a slope

#### ■ Automatic speed limiter cancelation

The set speed is automatically canceled when cruise control is activated.

#### ■ If the speed limiter indicator comes on in yellow (vehicles with a drive monitor display) or “Check speed limiter system.” is displayed on the multi-information display (vehicles with a multi-information display)

Stop the engine and then restart the engine. After restarting the engine, set the speed limiter. If the speed limiter cannot be set, there may be a malfunction in the speed limiter. Have the vehicle inspected by any authorized Toyota dealer or repairer, or another duly qualified and equipped professional.

#### ⚠ WARNING

##### ■ To avoid operating the speed limiter by mistake

Keep the speed limiter button off when not in use.

##### ■ Situations unsuitable for speed limiter

Do not use speed limiter in either of the following situations.

Doing so may result in control of the vehicle being lost and could cause an accident resulting in death or serious injury.

- On slippery roads, such as those covered with rain, ice or snow
- On steep hills
- When your vehicle is towing a trailer or during emergency towing



## Toyota parking assist-sensor\*

The distance from your vehicle to nearby obstacles when parallel parking or maneuvering into a garage is measured by the sensors and communicated via the multi-information display and a buzzer. Always check the surrounding area when using this system.

### ■ Types of sensors

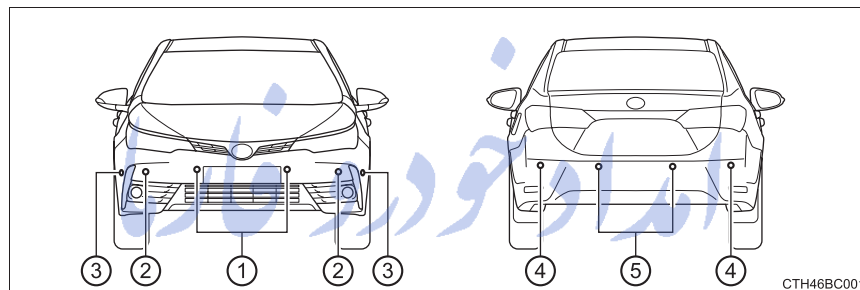

- ① Front center sensors
- ② Front corner sensors
- ③ Front side sensors\*
- ④ Rear corner sensors
- ⑤ Rear center sensors

\*: 10 sensor models

4

Driving

FarmaSOS.com

\*: If equipped

■ **Enabling/disabling the Toyota parking assist-sensor system**

This system can be enabled/disabled on the multi-information display.

- 1 Display the settings display (→P. 101), and then press  $\wedge / \vee$  on the meter control switches to select .

- 2 Press  on the meter control switches to enable/disable the system.

When enabled, the Toyota parking assist-sensor indicator will illuminate.

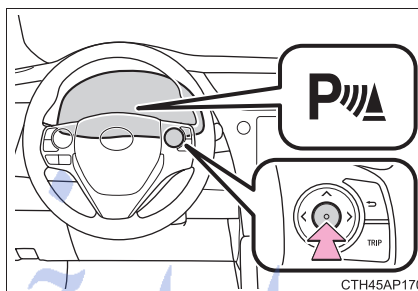

**Display**

When the sensors detect an obstacle, a graphic is shown on the multi information display depending on the position and distance to the obstacle.

- 1 Front center sensor operation
- 2 Front corner sensor and front side sensor\* operation
- 3 Rear corner sensor operation
- 4 Rear center sensor operation

\*: 10 sensor models

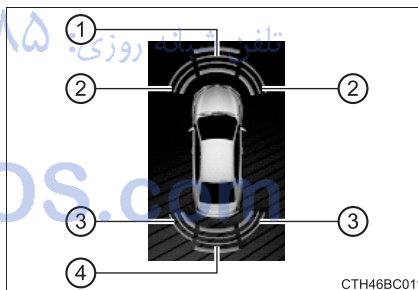

**Sensor detection display, obstacle distance**

■ **Distance display**

Sensors that detect an obstacle will illuminate continuously or blink.

Display	Approximate distance to obstacle	
	Corner sensors/ front side sensors*	Center sensors
 (continuous)	—	Front: 100 to 55 cm (3.3 to 1.8 ft.) Rear: 150 to 55 cm (4.9 to 1.8 ft.)
 (continuous)	50 to 37.5 cm (1.6 to 1.2 ft.)	55 to 42.5 cm (1.8 to 1.4 ft.)
 (continuous)	37.5 to 25 cm (1.2 to 0.8 ft.)	42.5 to 30 cm (1.4 to 1.0 ft.)
 (blinking)	Less than 25 cm (0.8 ft.)	Less than 30 cm (1.0 ft.)
 (continuous)	Less than 25 cm (0.8 ft.)	—

\*: 10 sensor models

■ **Buzzer operation and distance to an obstacle**

A buzzer sounds when the sensors are operating.

- The buzzer beeps faster as the vehicle approaches an obstacle. When the vehicle comes within the following distance of the obstacle, the buzzer sounds continuously:
  - Corner sensors and front side sensors\*: Approximately 25 cm (0.8 ft.)
  - Center sensors: Approximately 30 cm (1.0 ft.)
- When 2 or more obstacles are detected simultaneously, the buzzer system responds to the nearest obstacle. If one or both come within the above distances, the beep will repeat a long tone, followed by fast beeps.

\*: 10 sensor models

**Detection range of the sensors**

- ① Approximately 100 cm (3.3 ft.)
- ② Approximately 150 cm (4.9 ft.)
- ③ Approximately 25 cm (0.8 ft.)\*
- ④ Approximately 50 cm (1.6 ft.)
- ⑤ Approximately 50 cm (1.6 ft.)

The diagram shows the detection range of the sensors. Note that the sensors cannot detect obstacles that are extremely close to the vehicle.

The range of the sensors may change depending on the shape of the object etc.

\*: 10 sensor models

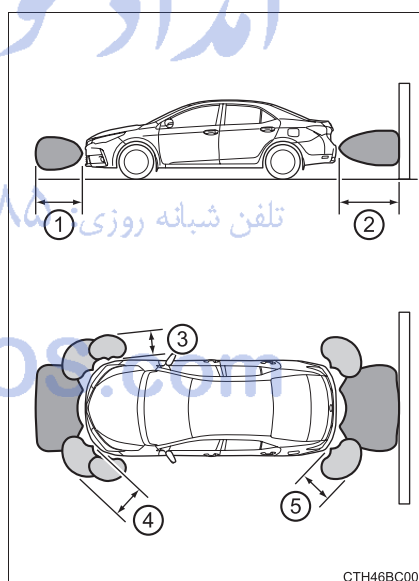

**■ The Toyota parking assist-sensor can be operated when**

Vehicles without a smart entry & start system:

The engine switch is in the "ON" position.

Vehicles with a smart entry & start system:

The engine switch is in IGNITION ON mode.

**● Front sensors:**

- Vehicles with a Multidrive:  
The shift lever is in a position other than P.
- Vehicles with a multi-mode manual transmission or manual transmission:  
The parking brake is not applied.
- The vehicle speed is less than about 10 km/h (6 mph).  
(At any speed when the shift lever is in R)

**● Rear sensors:**

The shift lever is in R.

**■ Sensor detection information**

● Certain vehicle conditions and the surrounding environment may affect the ability of the sensor to correctly detect obstacles. Particular instances where this may occur are listed below.

- There is dirt, snow or ice on the sensor.
- A sensor is frozen.
- A sensor is covered in any way.
- The vehicle is leaning considerably to one side.
- On an extremely bumpy road, on an incline, on gravel, or on grass.
- The vicinity of the vehicle is noisy due to vehicle horns, motorcycle engines, air brakes of large vehicles, or other loud noises producing ultrasonic waves.
- There is another vehicle equipped with parking assist sensors in the vicinity.
- A sensor is coated with a sheet of spray or heavy rain.
- The vehicle is equipped with a fender pole or wireless antenna.
- Towing eyelet is installed.
- A bumper or sensor receives a strong impact.
- The vehicle is approaching a tall or curved curb.
- In harsh sunlight or intense cold weather.
- A non-genuine Toyota suspension (lowered suspension etc.) is installed.

In addition to the examples above, there are instances in which, because of their shapes, signs and other objects may be judged by the sensor to be closer than they are.

- The shape of the obstacle may prevent the sensor from detecting it. Pay particular attention to the following obstacles:
  - Wires, fences, ropes, etc.
  - Cotton, snow and other materials that absorb sound waves
  - Sharply-angled objects
  - Low obstacles
  - Tall obstacles with upper sections projecting outwards in the direction of your vehicle

■ **If “Clean sonar.” is displayed on the multi-information display**

A sensor may be dirty or covered with snow or ice. In this case, clean the sensor and the system should return to normal.

If a sensor is frozen due to low temperatures, a warning message may be displayed or an obstacle may not be detected. When the sensor thaws out, the system should return to normal.

■ **If “Check sonar system.” is displayed on the multi-information display**

The system may not operate due to the malfunction of a sensor.

Have the vehicle inspected by any authorized Toyota dealer or repairer, or another duly qualified and equipped professional.

 **WARNING**

■ **Caution when using the Toyota parking assist-sensor**

Observe the following precautions.

Failing to do so may result in the vehicle being unable to be driven safely and possibly cause an accident.

- Do not use the sensor at speeds in excess of 10 km/h (6 mph).
- Do not attach any accessories within the sensor range.

 **NOTICE**

■ **Notes on the Toyota parking assist-sensor**

- Do not apply intensive bursts of water or steam to the sensor area. Doing so may result in the sensor malfunctioning.
- If your vehicle is involved in an accident, it will affect the sensors and may result in a system failure. Contact any authorized Toyota dealer or repairer, or another duly qualified and equipped professional.

## Simple-IPA (Simple-Intelligent Parking Assist)\*

Simple-IPA is a system that assists parallel parking operations. When parking between two parked vehicles or in the space behind one parked vehicle, the sensors installed on the sides of the front bumper are utilized and a space which the vehicle can be parked in is detected. Parking operations are then assisted by automatic operation of the steering wheel.

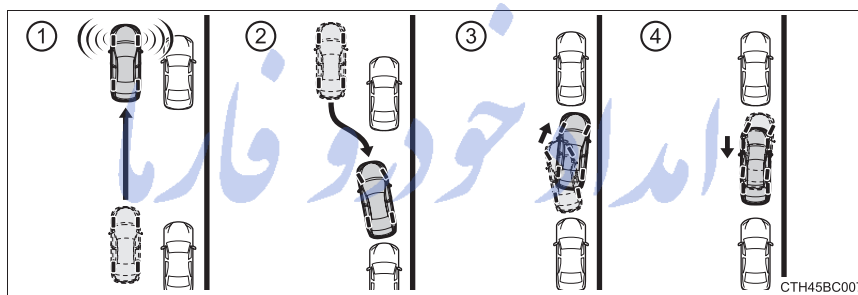

- ① Detecting allowable parking space
- ② Parking the vehicle in a detected parking space\*
- ③ Turning the steering wheel to park in the target parking space\*
- ④ Parking in the target parking space is complete\*

\*: The steering wheel is operated automatically.

### Simple-IPA switch and multi-information display

- ① Simple-IPA switch
- ② Display
- ③ Indicator

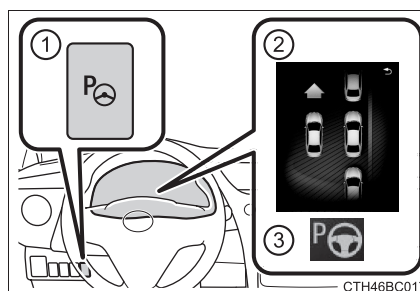

\*: If equipped

### Operating Simple-IPA

Operate Simple-IPA according to the multi-information display and the buzzer.

The system detects parking spaces on the front passenger's side of the vehicle and assists with parking in a detected space.

When parking in a space on the driver's side of the vehicle, move the turn signal lever to indicate turning on the driver's seat side. Leave the turn signal lever in that position until automatic steering begins.

- 1 Turn the Simple-IPA switch on with the vehicle driving at 30 km/h (18 mph) or less.

The multi-information display changes to the parking space detection screen when the system is operating.

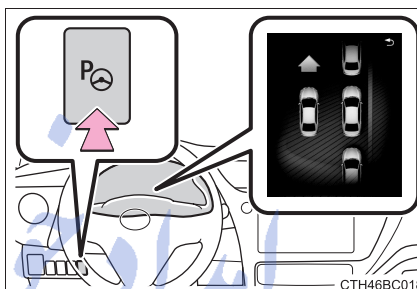

- 2 Drive the vehicle while maintaining a distance of approximately 1 m (3 ft.) from the parked vehicles.

Drive the vehicle as parallel to the parked vehicles and curb as possible.

Lower vehicle speeds allow the system to assist in parking the vehicle more parallel to the parked vehicles and curb, and in a more proper position between vehicles at the front and rear of a parking space.

The required length for a parking space to be detected is the total vehicle length plus approximately 1 m (3 ft.).

Maintain a vehicle speed of 30 km/h (18 mph) or less.





- 3 When the multi-information display changes, reduce the vehicle speed.

Move the vehicle forward slowly until the buzzer sounds.

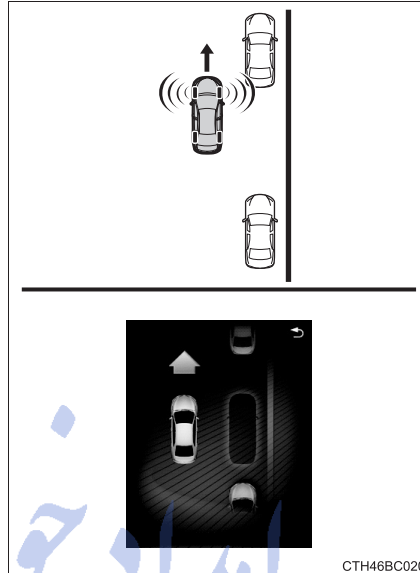

- 4 Stop the vehicle when the buzzer sounds.

The multi-information display will change.

Visually check that the detected space is safe for parking.

If the vehicle moves 10 m (32 ft.) or more after the buzzer sounds, detection of a new parking space will begin.



5 Shift the shift lever to R.

The multi-information display will change and automatic steering will begin. While taking care not to catch your hands on the steering wheel and checking the safety of the surrounding area, reverse the vehicle slowly by operating the accelerator and brake pedals. During automatic steering, maintain a vehicle speed of 6 km/h (3 mph) or less.



6 When the multi-information display changes, reduce the vehicle speed.

While checking the safety of the area behind the vehicle, reverse the vehicle slowly.



- 7 When the rear Toyota parking assist-sensor's warning buzzer sounds continuously, completely stop the vehicle immediately.

The multi-information display will change when the warning buzzer starts sounding continuously.

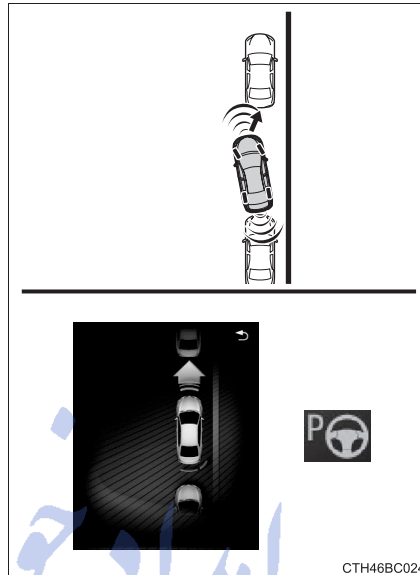

- 8 Shift the shift lever to D (Multidrive), E, M (multi-mode manual transmission) or 1 (manual transmission).

While the steering wheel is turning, keep the vehicle at a complete stop. When the steering wheel stops turning, move the vehicle forward slowly while checking the safety of the area in front of the vehicle.

- 9 When the front Toyota parking assist-sensor's warning buzzer sounds continuously, completely stop the vehicle immediately.

The multi-information display will change when the warning buzzer starts sounding continuously.

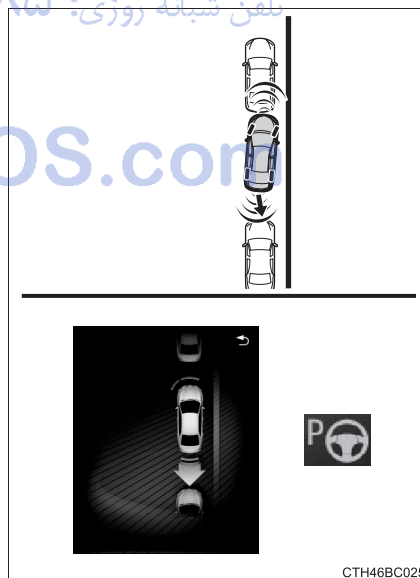

10 Shift the shift lever to R.

While the steering wheel is turning, keep the vehicle at a complete stop. When the steering wheel stops turning, reverse the vehicle slowly while checking the safety of the area behind the vehicle.

11 Repeat steps 7 through 10 until the parking assist operation has completed.

When the parking assist operation has completed, the buzzer sounds and the multi-information display changes.

Adjust the vehicle position and/or angle as necessary to complete parking the vehicle.

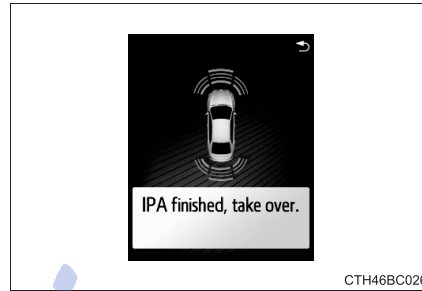

CTH46BC026

امداد خودرو فارما



تلفن شبانه روزی: ۰۲۱-۸۸۸۶۲۰۸۵



FarmaSOS.com

**When a message is shown on the multi-information display**

Message	Cause	What to do
"IPA slot not detected, speed too high."	The vehicle speed exceeded 30 km/h (18 mph).	Reduce vehicle speed to 30 km/h (18 mph) or less.
"IPA cancelled, take over."	The Simple-IPA switch was turned off.	Turn the Simple-IPA switch on.
	The Simple-IPA switch was turned on while reversing.	Park the vehicle manually or detect another parking space.
	The shift lever was shifted to R during detection of a parking space.	Park the vehicle manually or detect another parking space.
	The shift lever was shifted to a position other than R after the automatic steering began and before the vehicle enters a parking space.	Park the vehicle manually or detect another parking space.
	The steering wheel could not be turned sufficiently due to reasons such as low tire pressure, tire wear, the influence of road conditions, being on a slope, etc., therefore the vehicle could not be parked in the desired space.	<ul style="list-style-type: none"> <li>• Check tires for wear and pressure.</li> <li>• If this message is displayed when the vehicle is parked in other spaces, have the vehicle inspected by any authorized Toyota dealer or repairer, or another duly qualified and equipped professional.</li> </ul>

Message	Cause	What to do
"IPA cancelled, take over."	The power steering temporarily overheated.	Attempt to use Simple-IPA after waiting a little while.
	Possible system malfunction.	Have the vehicle inspected by any authorized Toyota dealer or repairer, or another duly qualified and equipped professional.
"IPA cancelled, take over, driver intervened."	The steering wheel was manually operated during automatic steering.	Park the vehicle manually or detect another parking space.
"IPA cancelled, take over, speed too high."	The vehicle speed exceeded 50 km/h (31 mph) during detection of a parking space.	Reduce vehicle speed to 30 km/h (18 mph) or less and turn the Simple-IPA switch on.
	The vehicle speed exceeded 6 km/h (3 mph) during automatic steering.	Park the vehicle manually or detect another parking space.
"IPA cancelled, take over, TRC/ABS/VSC activated."	The TRC, ABS or VSC operated.	<ul style="list-style-type: none"> <li>If the operation was canceled during detection of a parking space, turn the Simple-IPA switch on again.</li> <li>If the operation was canceled during automatic steering, park the vehicle manually or detect another parking space.</li> </ul>

Message	Cause	What to do
"IPA cancelled, take over, TRC/VSC is off."	The  switch was turned off.	Turn the  switch on.
"IPA cancelled, take over, timeout."	More than 6 minutes have elapsed since the Simple-IPA switch was turned on and the shift lever was shifted to R, before automatic steering could begin.	Park the vehicle manually or detect another parking space.
	More than 6 minutes have elapsed since the shift lever was shifted to R and automatic steering began, before the parking assist operation could complete.	Park the vehicle manually or detect another parking space.
	The total stop time during automatic steering exceeded 2 minutes.	Park the vehicle manually or detect another parking space.
"IPA cancelled, take over, check IPA system."	System malfunction.	Have the vehicle inspected by any authorized Toyota dealer or repairer, or another duly qualified and equipped professional.
"IPA not available."	The power steering is temporarily overheating.	Attempt to use Simple-IPA after waiting a little while.
	The engine has not been started.	Start the engine.
	Possible system malfunction.	Have the vehicle inspected by any authorized Toyota dealer or repairer, or another duly qualified and equipped professional.

Message	Cause	What to do
"IPA not available, speed too high."	Excessive vehicle speed (over 50 km/h [31 mph])	Reduce vehicle speed to 30 km/h (18 mph) or less and turn the Simple-IPA switch on.
"IPA not available, TRC/VSC is off."	The  switch is off.	After turning the  switch on, turn the Simple-IPA switch on.
"IPA not available, stop the vehicle, turn wheel from left end to right end."	System initialization has not been performed since the battery was disconnected/reconnected.	Perform initialization. →P. 310
"Check IPA system."	System malfunction.	Have the vehicle inspected by any authorized Toyota dealer or repairer, or another duly qualified and equipped professional.

تلفن شبانه روزی: ۰۲۱-۸۸۶۲۰۸۵

FarmaSOS.com



**■ Operation conditions of Simple-IPA**

- The engine is started.
- The  switch is on.
- The vehicle speed is 30 km/h (18 mph) or less. (During automatic steering, the vehicle speed is 6 km/h [3 mph] or less.)

**■ Canceling of the Simple-IPA operation**

Simple-IPA operation will be canceled when:

- The Simple-IPA switch is turned off.
- The ABS, VSC or TRC is operating.
- The shift lever is shifted to R during detection of a parking space.
- The shift lever is shifted to R and the vehicle is reversed 1 m (3 ft.) or more after a parking space has been detected and before the buzzer sounds.
- The steering wheel is operated manually during automatic steering.
- It takes more than 6 minutes for automatic steering to begin after the Simple-IPA switch is turned on and the shift lever is shifted to R.
- The shift lever is shifted to a position other than R after the automatic steering began and before the vehicle enters a parking space.
- It takes more than 6 minutes to complete parking after the shift lever was shifted to R and automatic steering began.
- The total stop time during automatic steering exceeds 2 minutes.

**■ Resume function of Simple-IPA**

If Simple-IPA is canceled due to one of the following operations, Simple-IPA operation may be able to be resumed by pressing the Simple-IPA switch depending on conditions such as the vehicle stopped position and steering wheel angle.

- The steering wheel is operated manually during automatic steering.
- The vehicle speed exceeds 6 km/h (3 mph) during automatic steering.
- The shift lever is moved to a position other than R after the automatic steering began and before the vehicle enters a parking space.

If operation is not resumed, park the vehicle manually or detect another parking space.

■ **When using Simple-IPA repeatedly**

When Simple-IPA is used repeatedly, the power steering may overheat temporarily. It may deactivate or cancel Simple-IPA operation. In this case, wait a few minutes before using Simple-IPA again.

■ **Toyota parking assist-sensor operation during Simple-IPA operation**

Even if the Toyota parking assist-sensor switch is turned off while Simple-IPA is activated, the Toyota parking assist-sensor will keep operating. In this case, when Simple-IPA operation is complete or canceled, the Toyota parking assist-sensor will be deactivated.

■ **Stop & Start system operation during Simple-IPA operation (vehicles with a Stop & Start system)**

The Stop & Start system does not operate during Simple-IPA operation. If the Simple-IPA switch is turned on during Stop & Start system operation, Stop & Start system operation will be canceled.

■ **When the cabin temperature is high**

The sensors may not work properly when the cabin temperature is high due to parking the vehicle in the sun. Use Simple-IPA after the cabin cools down.

■ **Sensors used by Simple-IPA**

→P. 293

■ **Initializing Simple-IPA**

Within 15 seconds of turning the Simple-IPA switch on, turn the steering wheel all the way to the left or right and then to the opposite side.

When the parking space detection screen is displayed, the initialization is complete.

If pressing the Simple-IPA switch again still shows "IPA not available, stop the vehicle, turn wheel from left end to right end." on the multi-information display, the initialization has failed. Have the vehicle inspected at any authorized Toyota dealer or repairer, or another duly qualified and equipped professional.

 **WARNING**

■ **Cautions regarding the use of Simple-IPA**

- Never depend on the Simple-IPA entirely when parking. The driver is responsible for safety. Use caution, just as you would when parking any vehicle.
- Back up slowly, using the brake pedal to control the vehicle's speed.
- If it seems likely to hit nearby vehicles, obstacles, or people, depress the brake pedal to stop the vehicle, and the disable the system.

 **WARNING****■ Conditions in which the use of Simple-IPA is prohibited**

Do not use Simple-IPA under the following conditions. Doing so may cause improper operation and lead to an unexpected accident.

- On sharp bends or slopes.
- On slippery or icy roads, or in snow.
- On uneven road surfaces such as gravel.
- During bad weather such as heavy rain, fog, snow, or a sandstorm.
- When the tires are extremely worn or tire pressure is low.
- When the vehicle has improper wheel alignment due to tires having received a strong impact such as bumping against a curb.
- When the compact spare tire (if equipped) or snow chains are installed.
- When the tires slid while attempting to park.
- When fallen leaves or snow is in a parking space.
- When items such as a towing bracket, trailer, bicycle carrier, etc. are installed on the rear of the vehicle.
- When a vehicle of which the front/rear end is above the detection area, such as a truck, bus or vehicle with a towing bracket, trailer, bicycle carrier, etc., is parked at the front or rear of the parking space.
- If the front bumper has been damaged.
- If the sensor is covered by the front bumper cover, etc.
- If a vehicle or obstacle is not in a suitable position at the front or rear of the parking space.

**■ Automatic steering precautions**

As the steering wheel moves automatically in the parking assist function, be aware of the following point.

- Keep clothing such as neckties, scarves and long sleeves away from the steering wheel, as they may become entangled. Also, keep children away from the steering wheel.
- If you have long fingernails, be careful not to injure yourself when the steering wheel moves.

 NOTICE

**■ When using the Simple-IPA**

- Check that the parking space is suitable. (Width of the space, if there are any obstacles, road surface condition, etc.)
- Simple-IPA will not operate properly if the vehicle at the front or back of the parking space moves, or if an obstacle enters the parking space after the sensors have detected the parking space. Always check the surrounding area during parking assist operation.
- The sensors may not be able to detect curbs. The vehicle may drive onto the curb depending on the situation, such as if a vehicle at the front or back of the parking space has driven on the curb. Check the surrounding area to prevent the tires and wheels from being damaged.

- When reversing, reverse the vehicle slowly to prevent the front end of the vehicle from hitting an obstacle in the front of the vehicle.

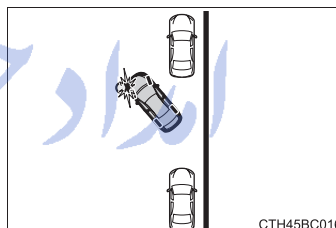

- When reversing, reverse the vehicle slowly to prevent the front end of the vehicle from hitting the vehicle parked in front of the parking space.

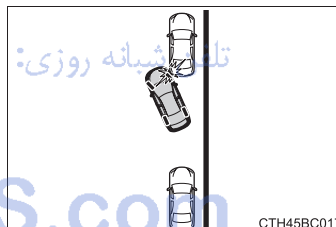

- The vehicle may not be able to be parked at a target parking space if the vehicle moves forward when the shift lever is in R or reverses when the shift lever is in a position other than R, such as when parking on a slope.

## Diesel particulate filter system (diesel engine only)

When the deposit collected by the filter reaches a predetermined amount, it is automatically cleaned.

### ■ Cleaning the DPF catalytic converter

Cleaning the DPF catalytic converter is performed as necessary in accordance with driving conditions.

### ■ Equipment characteristics

The DPF system has the following characteristics:

- Idle speed increases during cleaning
- The smell of the exhaust gas changes
- When starting the engine, white-colored steam (water vapor) may be expelled during cleaning
- Acceleration performance may degrade during cleaning

### ■ Replacing the engine oil

→P. 447

#### WARNING

#### ■ Exhaust pipe

Do not touch the exhaust pipe during cleaning, as the exhaust pipe and exhaust gases will become particularly hot. Also, make sure that there are no people or flammable materials near the exhaust pipe while the vehicle is stopped.

Failure to do so may cause injury by burning or a fire.

#### NOTICE

#### ■ To prevent the DPF system from failing

- Do not use fuel other than the specified type
- Do not use engine oil other than the recommended type
- Do not modify the exhaust pipe

## Driving assist systems

To help enhance driving safety and performance, the following systems operate automatically in response to various driving situations. Be aware, however, that these systems are supplementary and should not be relied upon too heavily when operating the vehicle.

### ◆ ABS (Anti-lock Brake System)

Helps to prevent wheel lock when the brakes are applied suddenly, or if the brakes are applied while driving on a slippery road surface

### ◆ Brake assist

Generates an increased level of braking force after the brake pedal is depressed when the system detects a panic stop situation

### ◆ VSC (Vehicle Stability Control)

Helps the driver to control skidding when swerving suddenly or turning on slippery road surfaces

### ◆ TRC (Traction Control)

Helps to maintain drive power and prevent the drive wheels from spinning when starting the vehicle or accelerating on slippery roads

### ◆ Hill-start assist control

- ▶ Except for vehicles with a diesel engine for Turkey

Helps to reduce the backward movement of the vehicle when starting on an uphill

- ▶ Vehicles with a diesel engine for Turkey

→P. 321

### ◆ EPS (Electric Power Steering)

Employs an electric motor to reduce the amount of effort needed to turn the steering wheel

### ◆ Emergency brake signal

When the brakes are applied suddenly, the emergency flashers automatically flash to alert the vehicle behind.

### When the TRC/VSC systems are operating

The slip indicator light will flash while the TRC/VSC systems are operating.

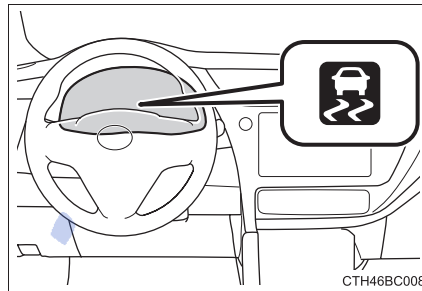

CTH46BC008

### Disabling the TRC system

If the vehicle gets stuck in mud, dirt or snow, the TRC system may reduce power from the engine to the wheels. Pressing  to turn the system off may make it easier for you to rock the vehicle in order to free it.

#### ▶ Vehicles with a drive monitor display

To turn the TRC system off, quickly press and release



The "TRC OFF" indicator light will come on.

Press  again to turn the system back on.

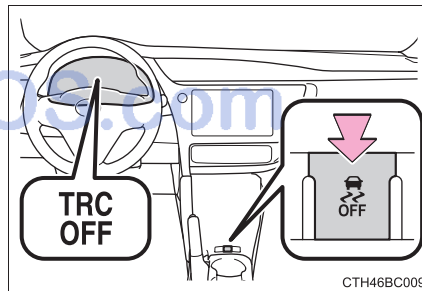

CTH46BC009

▶ Vehicles with a multi-information display

To turn the TRC system off, quickly press and release



The “TRC OFF” will be shown on the multi-information display.

Press  again to turn the system back on.

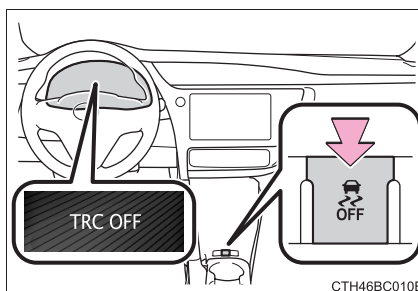

■ Turning off both TRC and VSC systems

▶ Vehicles with a drive monitor display

To turn the TRC and VSC systems off, press and hold  for more than 3 seconds while the vehicle is stopped.

The “TRC OFF” indicator light and VSC OFF indicator light will come on.

Press  again to turn the systems back on.

▶ Vehicles with a multi-information display

To turn the TRC and VSC systems off, press and hold  for more than 3 seconds while the vehicle is stopped.

The VSC OFF indicator light will come on and the “TRC OFF” will be shown on the multi-information display.\*

Press  again to turn the systems back on.

\*: On vehicles with a PCS (Pre-Crash Safety system), the pre-crash brake assist and pre-crash braking functions will also be disabled. (→P. 258)

■ When the “TRC OFF” indicator light comes on even if the  has not been pressed (vehicles with a drive monitor display)

TRC cannot be operated. Contact any authorized Toyota dealer or repairer, or another duly qualified and equipped professional.



- **When the message is displayed on the multi-information display showing that TRC has been disabled even if  has not been pressed (vehicles with a multi-information display)**

TRC cannot be operated. Contact any authorized Toyota dealer or repairer, or another duly qualified and equipped professional.

- **Operating conditions of hill-start assist control (except for vehicles with a diesel engine for Turkey)**

When the following four conditions are met, the hill-start assist control will operate:

- Vehicles with a Multidrive: The shift lever is in a position other than P or N (when starting off forward/backward on an upward incline).
- Vehicles with a manual transmission: The shift lever is in a position other than R when starting off forward on an upward incline or the shift lever is in R when starting off backward on an upward incline.
- The vehicle is stopped.
- The accelerator pedal is not depressed.
- The parking brake is not engaged.

- **Automatic system cancelation of hill-start assist control (except for vehicles with a diesel engine for Turkey)**

The hill-start assist control will turn off in any of the following situations:

- Vehicles with a Multidrive: The shift lever is shifted to P or N.
- Vehicles with a manual transmission: The shift lever is shifted to R when starting off forward on an upward incline or the shift lever is shifted to other than R when starting off backward on an upward incline.
- The accelerator pedal is depressed.
- The parking brake is engaged.
- Approximately 2 seconds elapse after the brake pedal is released.

- **Sounds and vibrations caused by the ABS, brake assist, VSC, TRC and hill-start assist control systems**

- A sound may be heard from the engine compartment when the brake pedal is depressed repeatedly, when the engine is started or just after the vehicle begins to move. This sound does not indicate that a malfunction has occurred in any of these systems.
- Any of the following conditions may occur when the above systems are operating. None of these indicates that a malfunction has occurred.
  - Vibrations may be felt through the vehicle body and steering.
  - A motor sound may be heard also after the vehicle comes to a stop.
  - The brake pedal may pulsate slightly after the ABS is activated.
  - The brake pedal may move down slightly after the ABS is activated.

■ **EPS operation sound**

When the steering wheel is operated, a motor sound (whirring sound) may be heard. This does not indicate a malfunction.

■ **Automatic reactivation of TRC and VSC systems**

After turning the TRC and VSC systems off, the systems will be automatically re-enabled in the following situations:

- Vehicles without a smart entry & start system: When the engine switch is turned to the "LOCK" position  
Vehicles with a smart entry & start system: When the engine switch is turned off
- If only the TRC system is turned off, the TRC will turn on when vehicle speed increases  
If both the TRC and VSC systems are turned off, automatic re-enabling will not occur when vehicle speed increases.

■ **Reduced effectiveness of the EPS system**

The effectiveness of the EPS system is reduced to prevent the system from overheating when there is frequent steering input over an extended period of time. The steering wheel may feel heavy as a result. Should this occur, refrain from excessive steering input or stop the vehicle and turn the engine off. The EPS system should return to normal within 10 minutes.

■ **Operating conditions of emergency brake signal**

When the following three conditions are met, the emergency brake signal will operate:

- The emergency flashers are off.
- Actual vehicle speed is over 55 km/h (35 mph).
- The brake pedal is depressed in a manner that causes the system to judge from the vehicle deceleration that this is a sudden braking operation.

■ **Automatic system cancelation of emergency brake signal**

The emergency brake signal will turn off in any of the following situations:

- The emergency flashers are turned on.
- The brake pedal is released.
- The system judges from the vehicle deceleration that is not a sudden braking operation.

 WARNING**■ The ABS does not operate effectively when**

- The limits of tire gripping performance have been exceeded (such as excessively worn tires on a snow covered road).
- The vehicle hydroplanes while driving at high speed on wet or slick roads.

**■ Stopping distance when the ABS is operating may exceed that of normal conditions**

The ABS is not designed to shorten the vehicle's stopping distance. Always maintain a safe distance from the vehicle in front of you, especially in the following situations:

- When driving on dirt, gravel or snow-covered roads
- When driving with tire chains
- When driving over bumps in the road
- When driving over roads with potholes or uneven surfaces

**■ TRC/VSC may not operate effectively when**

Directional control and power may not be achievable while driving on slippery road surfaces, even if the TRC/VSC system is operating.

Drive the vehicle carefully in conditions where stability and power may be lost.

تلفن شبانه روزی: ۰۲۱-۸۸۶۲۰۸۵

FarmaSOS.com

 WARNING**■ Hill-start assist control does not operate effectively when (except for vehicles with a diesel engine for Turkey)**

- Do not overly rely on hill-start assist control. Hill-start assist control may not operate effectively on steep inclines and roads covered with ice.
- Unlike the parking brake, hill-start assist control is not intended to hold the vehicle stationary for an extended period of time. Do not attempt to use hill-start assist control to hold the vehicle on an incline, as doing so may lead to an accident.

**■ When the VSC is activated**

The slip indicator light flashes. Always drive carefully. Reckless driving may cause an accident. Exercise particular care when the indicator light flashes.

**■ When the TRC/VSC systems are turned off**

Be especially careful and drive at a speed appropriate to the road conditions. As these are the systems to help ensure vehicle stability and driving force, do not turn the TRC/VSC systems off unless necessary.

**■ Replacing tires**

Make sure that all tires are of the specified size, brand, tread pattern and total load capacity. In addition, make sure that the tires are inflated to the recommended tire inflation pressure level.

The ABS, TRC and VSC systems will not function correctly if different tires are installed on the vehicle.

Contact any authorized Toyota dealer or repairer, or another duly qualified and equipped professional for further information when replacing tires or wheels.

**■ Handling of tires and the suspension**

Using tires with any kind of problem or modifying the suspension will affect the driving assist systems, and may cause a system to malfunction.

## Hill-start assist control (vehicles with a diesel engine for Turkey)

**Assists with starting off and temporarily maintains braking power even if the foot is removed from the brake pedal when starting off on an incline or a slippery slope.**

To engage hill-start assist control, further depress the brake pedal when the vehicle is stopped completely.

A buzzer will sound once to indicate the system is activated. The slip indicator will also start flashing.

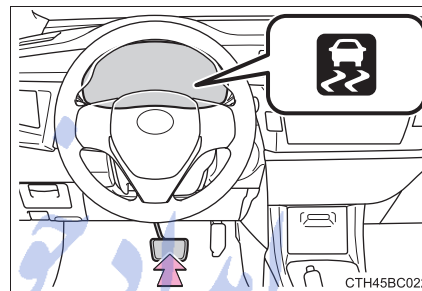

### ■ Hill-start assist control operating conditions

- The system operates in the following situations:
  - The parking brake is not applied.
  - The accelerator pedal is not depressed.
- Hill-start assist control cannot be operated while the slip indicator light is illuminated.

### ■ Hill-start assist control

- While hill-start assist control is operating, the brakes remain automatically applied after the driver releases the brake pedal. The stop lights and the high mounted stoplight turn on.
- Hill-start assist control operates for about 2 seconds after the brake pedal is released.
- If the slip indicator does not flash and the buzzer does not sound when the brake pedal is further depressed, slightly reduce the pressure on the brake pedal (do not allow the vehicle to roll backward) and then firmly depress it again. If the system still does not operate, check that the operating conditions explained above have been met.

■ **Hill-start assist control buzzer**

- When hill-start assist control is activated, the buzzer will sound once.
- In the following situations, hill-start assist control will be canceled and the buzzer will sound twice.
  - No attempt is made to drive the vehicle within approximately 2 seconds of releasing the brake pedal.
  - The parking brake is applied.
  - The brake pedal is depressed again.
  - The brake pedal has been depressed for more than approximately 3 minutes.

■ **If the slip indicator comes on**

It may indicate a malfunction in the system. Contact any authorized Toyota dealer or repairer, or another duly qualified and equipped professional.

 **WARNING**

■ **Hill-start assist control**

- Do not overly rely on hill-start assist control. Hill-start assist control may not operate effectively on steep inclines and roads covered with ice.
- Unlike the parking brake, hill-start assist control is not intended to hold the vehicle stationary for an extended period of time. Do not attempt to use hill-start assist control to hold the vehicle on an incline, as doing so may lead to an accident.

تلفن شبانه روزی: ۰۲۱-۸۸۶۲۰۸۵

FarmaSOS.com

## Winter driving tips

Carry out the necessary preparations and inspections before driving the vehicle in winter. Always drive the vehicle in a manner appropriate to the prevailing weather conditions.

### Preparation for winter

- Use fluids that are appropriate to the prevailing outside temperatures.
  - Engine oil
  - Engine coolant
  - Washer fluid
- Have a service technician inspect the condition of the battery.
- Have the vehicle fitted with four snow tires or purchase a set of tire chains for the front tires.

Ensure that all tires are the same size and brand, and that chains match the size of the tires.

### Before driving the vehicle

Perform the following according to the driving conditions:

- Do not try to forcibly open a window or move a wiper that is frozen. Pour warm water over the frozen area to melt the ice. Wipe away the water immediately to prevent it from freezing.
- To ensure proper operation of the climate control system fan, remove any snow that has accumulated on the air inlet vents in front of the windshield.
- Check for and remove any excess ice or snow that may have accumulated on the exterior lights, vehicle's roof, chassis, around the tires or on the brakes.
- Remove any snow or mud from the bottom of your shoes before getting in the vehicle.

**When driving the vehicle**

Accelerate the vehicle slowly, keep a safe distance between you and the vehicle ahead, and drive at a reduced speed suitable to road conditions.

**When parking the vehicle**

Park the vehicle and move the shift lever to P (Multidrive) or 1 (manual transmission) or R (multi-mode manual transmission or manual transmission) without setting the parking brake. The parking brake may freeze up, preventing it from being released. If necessary, block the wheels to prevent inadvertent sliding or creeping.

**Selecting tire chains (except 215/45R17 tires)**

Use the correct tire chain size when mounting the tire chains. Chain size is regulated for each tire size.

Side chain:

- ① 3 mm (0.12 in.) in diameter
- ② 10 mm (0.39 in.) in width
- ③ 30 mm (1.18 in.) in length

Cross chain:

- ④ 4 mm (0.16 in.) in diameter
- ⑤ 14 mm (0.55 in.) in width
- ⑥ 25 mm (0.98 in.) in length

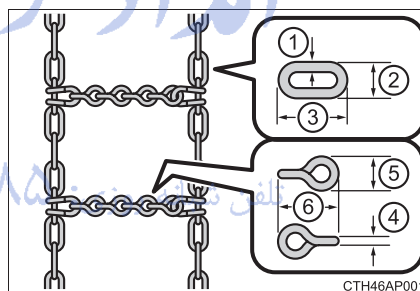
**Regulations on the use of tire chains**

Regulations regarding the use of tire chains vary depending on location and type of road. Always check local regulations before installing chains.



### ■ 215/45R17 tires

Tire chains cannot be installed on 215/45R17 tires.

### ■ Tire chain installation

Observe the following precautions when installing and removing chains:

- Install and remove tire chains in a safe location.
- Install tire chains on the front tires. Do not install tire chains on the rear tires.
- Install tire chains on front tires as tightly as possible. Retighten chains after driving 0.5 — 1.0 km (1/4 — 1/2 mile).
- Install tire chains following the instructions provided with the tire chains.

### ⚠ WARNING

#### ■ Driving with snow tires

Observe the following precautions to reduce the risk of accidents. Failure to do so may result in a loss of vehicle control and cause death or serious injury.

- Use tires of the specified size.
- Maintain the recommended level of air pressure.
- Do not drive at speeds in excess of the speed limit or the speed limit specified for the snow tires being used.
- Use snow tires on all, not just some wheels.

#### ■ Driving with tire chains

Observe the following precautions to reduce the risk of accidents. Failure to do so may result in the vehicle being unable to be driven safely, and may cause death or serious injury.

- Do not drive in excess of the speed limit specified for the tire chains being used, or 50 km/h (30 mph), whichever is lower.
- Avoid driving on bumpy road surfaces or over potholes.
- Avoid sudden acceleration, abrupt steering, sudden braking and shifting operations that cause sudden engine braking.
- Slow down sufficiently before entering a curve to ensure that vehicle control is maintained.
- Vehicles with a LDA (Lane Departure Alert) system: Do not use the LDA system.

 NOTICE

■ **Repairing or replacing snow tires**

Request repairs or replacement of snow tires from Toyota dealers or legitimate tire retailers.

This is because the removal and attachment of snow tires affects the operation of the tire pressure warning valves and transmitters.

■ **Fitting tire chains**

The tire pressure warning valves and transmitters may not function correctly when tire chains are fitted.

امداد خودرو فارما

تلفن شبانه روزی: ۰۲۱-۸۸۸۶۲۰۸۵

FarmaSOS.com

## Audio system

# 5

- 5-1. Basic Operations**
- Audio system types ..... 328
  - Steering wheel audio switches ..... 330
  - AUX port/USB port ..... 331
- 5-2. Using the audio system**
- Optimal use of the audio system ..... 332
- 5-3. Using the radio**
- Radio operation ..... 334
- 5-4. Playing audio CDs and MP3/WMA discs**
- CD player operation ..... 338
- 5-5. Using an external device**
- Listening to an iPod ..... 346
  - Listening to a USB memory device ..... 354
  - Using the AUX port ..... 361
- 5-6. Using Bluetooth® devices**
- Bluetooth® audio/phone ..... 362
  - Using the steering wheel switches ..... 367
  - Registering a Bluetooth® device ..... 368
- 5-7. "SET UP" menu**
- Using the "SET UP" menu ("Bluetooth" menu) ..... 369
  - Using the "SET UP" menu ("Phone" menu) ..... 374
- 5-8. Bluetooth® Audio**
- Operating a Bluetooth® enabled portable player ..... 379
- 5-9. Bluetooth® Phone**
- Making a phone call ..... 382
  - Receiving a phone call ..... 384
  - Speaking on the phone ..... 385
- 5-10. Bluetooth®**
- Bluetooth® ..... 387

### Audio system types\*

► Vehicles with an audio system

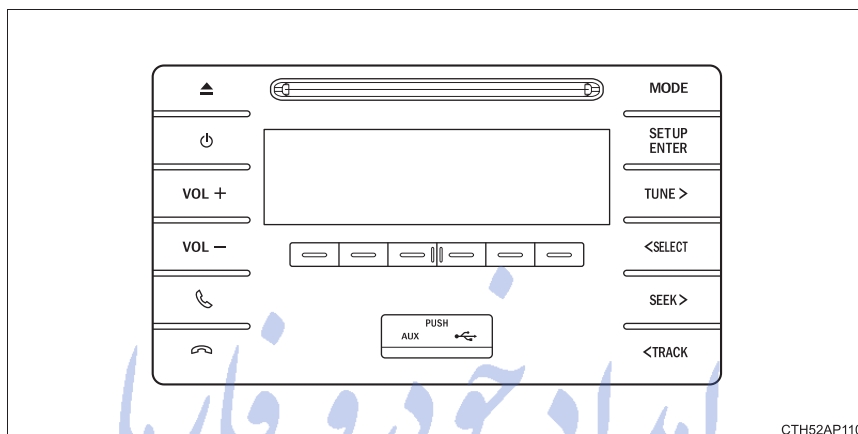

► Vehicles with a navigation/multimedia system

Owners of models equipped with a navigation/multimedia system should refer to the "Navigation and multimedia system Owner's manual".

تلفن شبانه روزی: ۰۲۱-۸۸۸۶۲۰۸۵

FarmaSOS.com

\*: If equipped

**■ Using cellular phones**

Interference may be heard through the audio system's speakers if a cellular phone is being used inside or close to the vehicle while the audio system is operating.

**■ About Bluetooth®**

The Bluetooth wordmark and logo are owned by Bluetooth SIG. and permission has been granted to use the trademark of the licensee Panasonic Corporation. Other trademarks and trade names are owned by various different owners.

 NOTICE**■ To prevent battery discharge**

Do not leave the audio system on longer than necessary when the engine is stopped.

**■ To avoid damaging the audio system**

Take care not to spill drinks or other fluids on the audio system.

تلفن شبانه روزی: ۰۲۱-۸۸۶۲۰۸۵

FarmaSOS.com

## Steering wheel audio switches

Some audio features can be controlled using the switches on the steering wheel.

Operation may differ depending on the type of audio system or navigation system. For details, refer to the manual provided with the audio system or navigation system.

### Operating the audio system using the steering wheel switches

- ① Volume switch:
  - Press: Increases/decreases volume
  - Press and hold: Continuously increases/decreases volume
- ② Radio mode:
  - Press: Selects a radio station
  - Press and hold: Seeks up/down

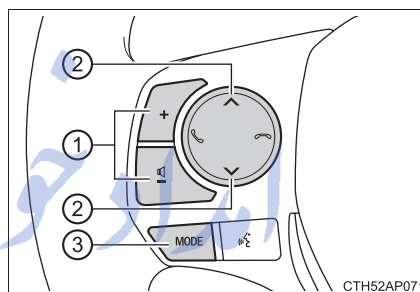

CD, MP3/WMA disc, Bluetooth<sup>®</sup>, iPod or USB mode:

- Press: Selects a track/file/song
  - Press and hold: Selects a folder or album (MP3/WMA disc, Bluetooth<sup>®</sup>, iPod or USB)
- ③ "MODE" switch:
    - Press: Turns the power on, selects an audio source
    - Press and hold: Mutes or pauses the current operation. To cancel the mute or pause, press and hold again.

#### WARNING

#### To reduce the risk of an accident

Exercise care when operating the audio switches on the steering wheel.

## AUX port/USB port

Connect an iPod, USB memory device or portable audio player to the AUX port/USB port as indicated below. Press the “MODE” button to select “iPod”, “USB” or “AUX”.

### Connecting using the AUX port/USB port

#### ■ iPod

Push the cover to open and connect an iPod using an iPod cable.

Turn on the power of the iPod if it is not turned on.

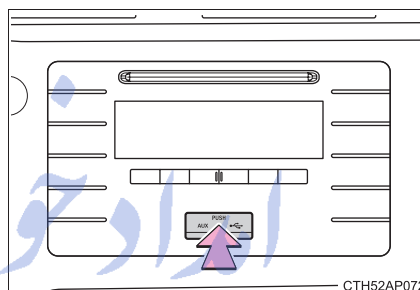

#### ■ USB memory

Push the cover to open and connect a USB memory device.

Turn on the power of the USB memory device if it is not turned on.

#### ■ Portable audio player

Push the cover to open and connect a portable audio player.

Turn on the power of the portable audio player if it is not turned on.

#### ⚠ WARNING

##### ■ While driving

Do not connect a device or operate the device controls.

## Optimal use of the audio system

Sound quality (treble/bass) and volume balance can be adjusted.

- ① Displays the current mode
- ② Changes the following settings
  - Sound quality and volume balance (→P. 332)
  - The sound quality and volume balance settings can be changed to produce the best sound.
  - Automatic Sound Levelizer on/off (→P. 333)
- ③ Selects a mode

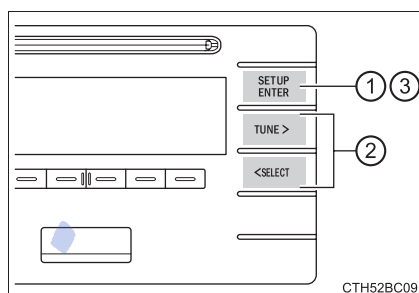

### Using the audio control function

#### ■ Changing sound quality modes

- 1 Press the "SETUP/ENTER" button.
- 2 Press the "<SELECT" or "TUNE>" button to select "Sound settings".
- 3 Press the "SETUP/ENTER" button.
- 4 Press the "<SELECT" or "TUNE>" button to select the desired mode.  
"Bass", "Treble", "Fader", "Balance", or "ASL"
- 5 Press the "SETUP/ENTER" button.



### ■ Adjusting sound quality

Pressing the “<SELECT” or “TUNE>” button adjusts the level.

Sound quality mode	Mode displayed	Level	Press the “<SELECT” button	Press the “TUNE>” button
Bass*	“Bass”	-5 to 5	Low	High
Treble*	“Treble”	-5 to 5		
Front/rear volume balance	“Fader”	F7 to R7	Shifts to rear	Shifts to front
Left/right volume balance	“Balance”	L7 to R7	Shifts to left	Shifts to right

\*: The sound quality level is adjusted individually in each audio mode.

### ■ Adjusting the Automatic Sound Levelizer (ASL)

When ASL is selected, pressing the “TUNE>” button changes the amount of ASL in the order of “Low”, “Mid” and “High”.

Pressing the “<SELECT” button turns ASL off.

ASL automatically adjusts the volume and tone quality according to the vehicle speed.

FarmaSOS.com

## Radio operation

Select "AM" or "FM" to begin listening to the radio.

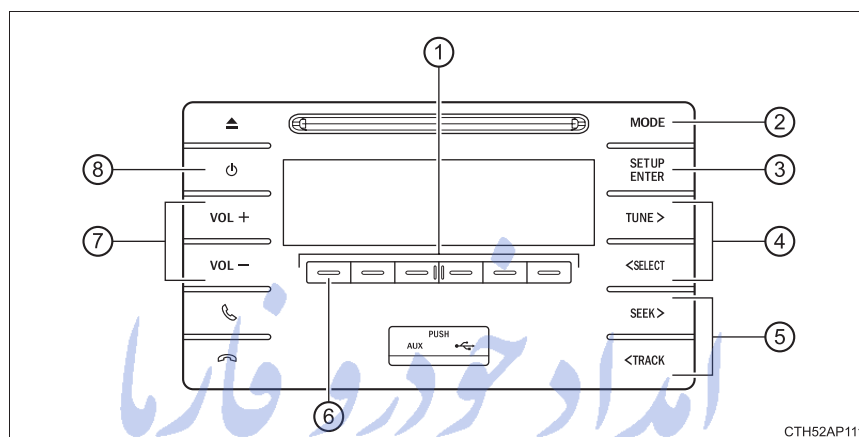

- ① Station selectors
- ② Mode select button
- ③ Select an item or AF/region code/TA mode setup
- ④ Adjust frequency
- ⑤ Seek a frequency
- ⑥ Display a station list
- ⑦ Volume
- ⑧ Power

FarmaSOS.com

### Setting station presets

- 1 Search for a desired station by pressing the “<SELECT” or “TUNE>” button.
- 2 Press and hold a desired station selector button until you hear a beep.

### Using the station list

#### ■ Updating the station list

- 1 Press  “List”.

The station list will be displayed.

- 2 Press  “Update” to update the list.

“Updating” is displayed while the searching is in process, and then available stations will be listed on the display.

To cancel the updating process, press  “Back”.

#### ■ Selecting a station from the station list

- 1 Press  “List”.

The station list will be displayed.

- 2 Press the “<SELECT” or “TUNE>” button to select a station.

- 3 Press the “SETUP/ENTER” button to tune in the station.

To return to the previous display, press  “Back”.

**RDS (Radio Data System)**

This feature allows your radio to receive RDS data.

**■ Listening to stations of the same network**

- 1 Press the "SETUP/ENTER" button.
- 2 Press the "<SELECT" or "TUNE>" button to select "Radio" and press the "SETUP/ENTER" button.
- 3 Press the "<SELECT" or "TUNE>" button to select the desired mode: "FM AF" or "Region code".
- 4 Press the "SETUP/ENTER" button to select "On" or "Off".

FM AF ON mode: The station among those of the same network with strong reception is selected.

Region code ON mode: The station among those of the same network with strong reception and broadcasting the same program is selected.

**■ Traffic information**

- 1 Press the "SETUP/ENTER" button.
- 2 Press the "<SELECT" or "TUNE>" button to select "Radio" and press the "SETUP/ENTER" button.
- 3 Press the "<SELECT" or "TUNE>" button to select "FM TA" mode.
- 4 Press the "SETUP/ENTER" button to select "On" or "Off".

TA mode: The system automatically switches to traffic information when a broadcast with a traffic information signal is received.

The station returns to the previous one when the traffic information ends.

**■ EON (Enhanced Other Network) system (for traffic announcement function)**

If the RDS station (with EON data) you are listening to is not broadcasting a traffic information program and the audio system is in the TA (traffic announcement) mode, the radio will be switched automatically to a station broadcasting a traffic information program in the EON AF list when traffic information begins.

**■ When the battery is disconnected**

Station presets are erased.

**■ Reception sensitivity**

- Maintaining perfect radio reception at all times is difficult due to the continually changing position of the antenna, differences in signal strength and surrounding objects, such as trains, transmitters, etc.
- The radio antenna is mounted on the rear side of the roof.

امداد خودرو فارما

تلفن شبانه روزی: ۰۲۱-۸۸۶۲۰۸۵

FarmaSOS.com

## CD player operation

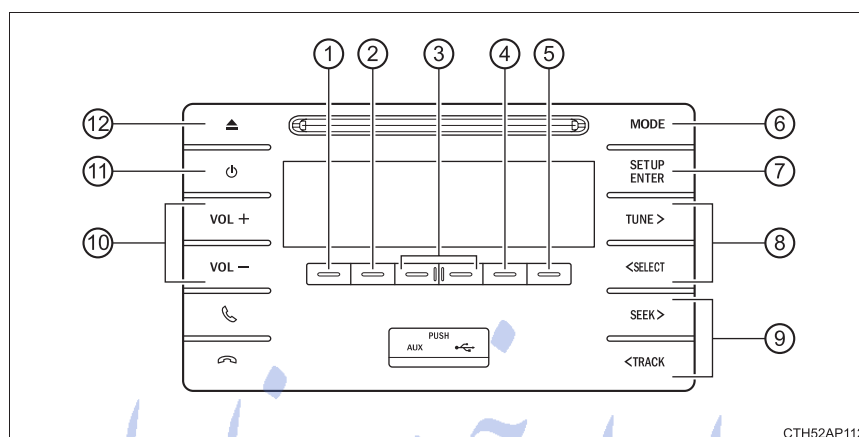

- CTH52AP112
- ① Display text message
  - ② Display folder list/track list
  - ③ Select a folder (MP3/WMA discs only)
  - ④ Repeat play
  - ⑤ Random playback
  - ⑥ Mode select button
  - ⑦ Open the selected track/file
  - ⑧ Select a track/file
  - ⑨ Select a track/file, fast-forward or reverse
  - ⑩ Volume
  - ⑪ Power
  - ⑫ Eject a disc

FarmaSOS.com

**Loading a CD, MP3 or WMA disc**

Insert a disc.

**Ejecting a CD, MP3 or WMA disc**

Press  and remove the disc.

**Using the CD player****■ Selecting a track**

Press the “TUNE>” or “SEEK>” button to move up or the “<SELECT” or “<TRACK” button to move down until the desired track number is displayed.

**■ Selecting a track from a track list**

1 Press  “List”.

The track list will be displayed.

2 Press the “<SELECT” or “TUNE>” button to select a track.

3 Press the “SETUP/ENTER” button to open the selected track.

To return to the previous display, press  “Back”.

**■ Fast-forwarding and reversing a track**

To fast-forward or reverse, press and hold the “SEEK>” or “<TRACK” button.

**■ Repeat play**

Press  “RPT”.

The current track is played repeatedly until  “RPT” is pressed again.

**■ Random playback**



Press  “RDM”.

Tracks are played in a random order until  “RDM” is pressed again.

**■ Switching the display**

Press  “Text”.

Track name, Artist name and CD title are shown on the display.

To return to the previous display, press  “Text” or  “Back”.

### Playing back an MP3 or WMA disc

#### ■ Selecting a folder

To select the desired folder, press  “<” or  “>”.

#### ■ Selecting a folder and file from a folder list

1 Press  “List”.

The folder list will be displayed.

2 Press the “<SELECT” or “TUNE>” button to select a folder or file.

3 Press the “SETUP/ENTER” button to open the selected file/folder.

To return to the previous display, press  “Back”.

#### ■ Returning to the first folder

Press and hold  “<” until you hear a beep.

#### ■ Selecting a file

Press the “<SELECT”, “TUNE>”, “<TRACK” or “SEEK>” button to select the desired file.

#### ■ Fast-forwarding and reversing a file

To fast-forward or reverse, press and hold the “SEEK>” or “<TRACK” button.

#### ■ Repeat play

Pressing  “RPT” changes the repeat play mode in the following order:

File repeat → Folder repeat\* → Off.



\*: Not available when RDM (random playback) is selected

#### ■ Random playback

Pressing  “RDM” changes the random playback mode in the following order:

Folder random → Disc random → Off.







### ■ Switching the display

Press  "Text".

Track title, Artist name and Album title (MP3 only) are shown on the display.

To return to the previous display, press  "Text" or  "Back".

### ■ Display

Depending on the contents recorded, the characters may not be displayed properly or may not be displayed at all.

### ■ Error messages

If an error message is displayed, refer to the following table and take the appropriate measures. If the problem is not rectified, take the vehicle to any authorized Toyota dealer or repairer, or another duly qualified and equipped professional.

Message	Cause	Correction procedures
"CD check"	<ul style="list-style-type: none"> <li>The disc is dirty or damaged.</li> <li>The disc is inserted upside down.</li> </ul>	<ul style="list-style-type: none"> <li>Clean the disc.</li> <li>Insert the disc correctly.</li> </ul>
"Error 3"	There is a malfunction within the system.	Eject the disc.
"Error 4"	An over current error has occurred.	Turn the engine switch to the "LOCK" position (vehicles without a smart key system) or turn the engine switch off (vehicles with a smart key system).
"No support"	MP3/WMA files are not included on the CD.	Eject the disc.

#### ■ Discs that can be used

Discs with the marks shown below can be used. Playback may not be possible depending on recording format or disc features, or due to scratches, dirt or deterioration.



CDs with copy-protection features may not play correctly.

#### ■ CD player protection feature

To protect the internal components, playback is automatically stopped when a problem is detected.

#### ■ If a disc is left inside the CD player or in the ejected position for extended periods

The disc may be damaged and may not play properly.

#### ■ Lens cleaners

Do not use lens cleaners. Doing so may damage the CD player.

#### ■ MP3 and WMA files

MP3 (MPEG Audio LAYER3) is a standard audio compression format.

Files can be compressed to approximately 1/10 of their original size by using MP3 compression.

WMA (Windows Media Audio) is a Microsoft audio compression format.

This format compresses audio data to a size smaller than that of the MP3 format.

MP3 and WMA file and media/format compatibility is limited.

#### ● MP3 file compatibility

- Compatible standards  
MP3 (MPEG1 LAYER3, MPEG2 LSF LAYER3)
- Compatible sampling frequencies  
MPEG1 LAYER3: 32, 44.1, 48 (kHz)  
MPEG2 LSF LAYER3: 16, 22.05, 24 (kHz)
- Compatible bit rates (compatible with VBR)  
MPEG1 LAYER3: 32, 40, 48, 56, 64, 80, 96, 112, 128, 160, 192, 224, 256, 320 (kbps)  
MPEG2 LSF LAYER3: 8, 16, 24, 32, 40, 48, 56, 64, 80, 96, 112, 128, 144, 160 (kbps)
- Compatible channel modes: stereo, joint stereo, dual channel and monaural

- WMA file compatibility

- Compatible standards  
WMA Ver. 7, 8, 9
- Compatible sampling frequencies  
32, 44.1, 48 (kHz)
- Compatible bit rates (only compatible with 2-channel playback)  
Ver. 7, 8: CBR 48, 64, 80, 96, 128, 160, 192 (kbps)  
Ver. 9: CBR 48, 64, 80, 96, 128, 160, 192, 256, 320 (kbps)

- Compatible media

Media that can be used for MP3 and WMA playback are CD-Rs and CD-RWs.

Playback in some instances may not be possible if the CD-R or CD-RW is not finalized. Playback may not be possible or the audio may jump if the disc is scratched or marked with fingerprints.

- Compatible disc formats

The following disc formats can be used.

- Disc formats: CD-ROM Mode 1 and Mode 2  
CD-ROM XA Mode 2, Form 1 and Form 2
- File formats: ISO9660 Level 1, Level 2, (Romeo, Joliet)  
MP3 and WMA files written in any format other than those listed above may not play correctly, and their file names and folder names may not be displayed correctly.

Items related to standards and limitations are as follows.

- Maximum directory hierarchy: 8 levels
- Maximum length of folder names/file names: 32 characters
- Maximum number of folders: 192 (including the root)
- Maximum number of files per disc: 255

- File names

The only files that can be recognized as MP3/WMA and played are those with the extension .mp3 or .wma.

- Multi-session discs

As the audio system is compatible with multi-session discs, it is possible to play discs that contain MP3 and WMA files. However, only the first session can be played.

- ID3 and WMA tags

ID3 tags can be added to MP3 files, making it possible to record the track title, artist name, etc.

The system is compatible with ID3 Ver. 1.0, 1.1, and Ver. 2.2, 2.3 ID3 tags. (The number of characters is based on ID3 Ver. 1.0 and 1.1.)

WMA tags can be added to WMA files, making it possible to record the track title and artist name in the same way as with ID3 tags.

- MP3 and WMA playback

When a disc containing MP3 or WMA files is inserted, all files on the disc are first checked. Once the file check is finished, the first MP3 or WMA file is played. To make the file check finish more quickly, we recommend you do not write in any files other than MP3 or WMA files or create any unnecessary folders.

If the discs contain a mixture of music data and MP3 or WMA format data, only music data can be played.

- Extensions

If the file extensions .mp3 and .wma are used for files other than MP3 and WMA files, they will be mistakenly recognized and played as MP3 and WMA files. This may result in large amounts of interference and damage to the speakers.

- Playback

- To play MP3 files with steady sound quality, we recommend a fixed bit rate of at least 128 kbps and a sampling frequency of 44.1 kHz.
- CD-R or CD-RW playback may not be possible in some instances, depending on the characteristics of the disc.
- There is a wide variety of freeware and other encoding software for MP3 and WMA files on the market, and depending on the status of the encoding and the file format, poor sound quality or noise at the start of playback may result. In some cases, playback may not be possible at all.
- When files other than MP3 or WMA files are recorded on a disc, it may take more time to recognize the disc and in some cases, playback may not be possible at all.
- Microsoft, Windows, and Windows Media are the registered trademarks of Microsoft Corporation in the U.S. and other countries.

 **WARNING**

■ **Certification for the CD player**

**CAUTION:**  
THIS PRODUCT IS A CLASS I LASER  
PRODUCT. USE OF CONTROLS OR  
ADJUSTMENTS OR PERFORMANCE OF  
PROCEDURES OTHER THAN THOSE  
SPECIFIED HEREIN MAY RESULT IN  
HAZARDOUS RADIATION EXPOSURE.  
DO NOT OPEN COVERS AND DO NOT  
REPAIR BY YOURSELF. REFER SERVICING  
TO QUALIFIED PERSONNEL.

 NOTICE

■ **Discs and adapters that cannot be used**

Do not use the following types of discs.

Also, do not use 8 cm (3 in.) disc adapters, Dual Discs or printable discs.

Doing so may damage the player and/or disc insert/eject function.

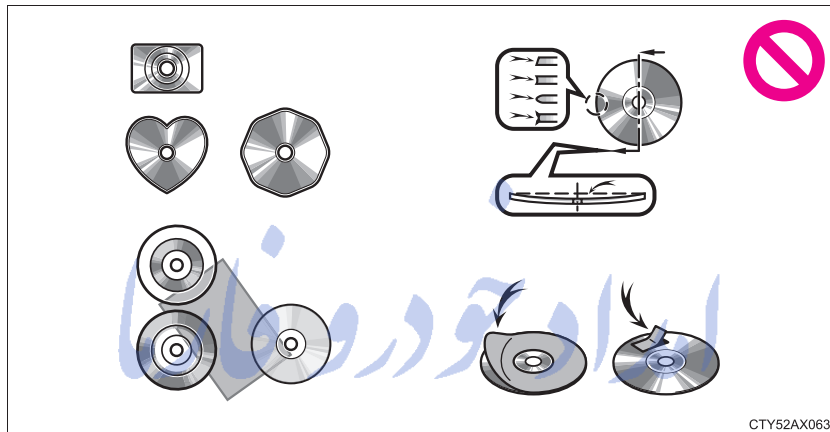

- Discs that have a diameter that is not 12 cm (4.7 in.).
- Low-quality or deformed discs.
- Discs with a transparent or translucent recording area.
- Discs that have tape, stickers or CD-R labels attached to them, or that have had the label peeled off.

■ **Player precautions**

Failure to follow the precautions below may result in damage to the discs or the player itself.

- Do not insert anything other than discs into the disc slot.
- Do not apply oil to the player.
- Store discs away from direct sunlight.
- Never try to disassemble any part of the player.

## Listening to an iPod

Connecting an iPod enables you to enjoy music from the vehicle speakers. Press the “MODE” button until “iPod” is displayed.

### Connecting an iPod

→P. 331

### Control panel

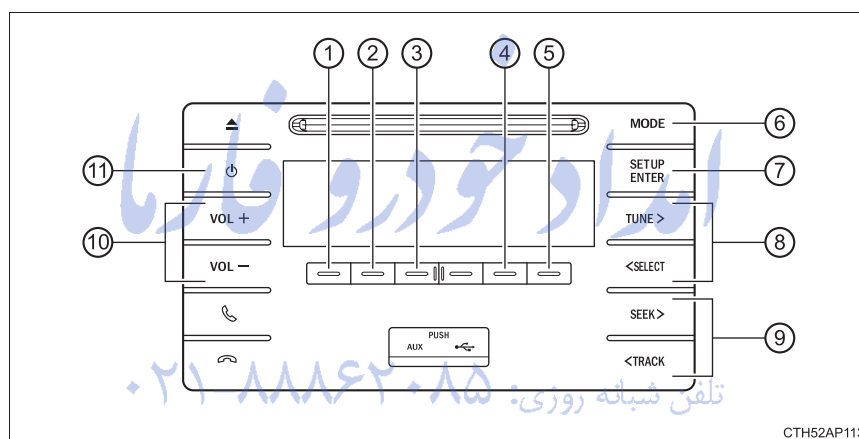

- |                        |  |
|------------------------|--|
| ① Display text message | ⑦ Set up menu                            |
| ② Display lists        | ⑧ Song selector                          |
| ③ iPod menu mode       | ⑨ Select a song, fast-forward or reverse |
| ④ Repeat play          | ⑩ Volume                                 |
| ⑤ Shuffle playback     | ⑪ Power                                  |
| ⑥ Mode select button   |  |

**Selecting a play mode**

- 1 Press  "Menu" to select iPod menu mode.
- 2 Pressing the "TUNE>" button changes the play mode in the following order:  
"Playlists"→"Artists"→"Albums"→"Songs"→  
"Podcasts"→"Genres"→"Composers"→"Audiobooks"
- 3 Press the "SETUP/ENTER" button to select the desired play mode.

امداد خودرو فارما

تلفن شبانه روزی: ۰۲۱-۸۸۸۶۲۰۸۵

FarmaSOS.com

### ■ Play mode list

Play mode	First selection	Second selection	Third selection	Fourth selection
"Playlists"	Playlist	Song	-	-
"Artists"	Artist	Album	Song	-
"Albums"	Album	Song	-	-
"Songs"	Song	-	-	-
"Podcasts"	Podcast	Episode	-	-
"Genres"	Genre	Artist	Album	Song
"Composers"	Composer	Album	Song	-
"Audiobooks"	Audiobook	Chapter	-	-

### ■ Selecting a list

- 1 Press the "<SELECT" or "TUNE>" button to display the first selection list.
- 2 Press the "SETUP/ENTER" button to select the desired item.  
Pressing this button changes the display to the second selection list.
- 3 Repeat the procedure to select the desired item.  
To return to the previous selection list, press  "Back".



**Selecting a song**

Press the “<SELECT”, “TUNE>”, “<TRACK” or “SEEK>” button to select the desired song.

**Selecting a song from the song list**

- 1 Press  “List”.

The song list will be displayed.

- 2 Press the “<SELECT” or “TUNE>” button to select a song.

- 3 Press the “SETUP/ENTER” button to play the song.

To return to the previous display, press  “Back”.

**Fast-forwarding and reversing a song**

To fast-forward or reverse, press and hold the “SEEK>” or “<TRACK” button.

**Repeat play**

Press  “RPT”.

To cancel, press  “RPT” again.

**Shuffle playback**



Pressing  “RDM” changes the shuffle playback mode in the following order:

Track shuffle → Album shuffle → Off.

**Switching the display**

Press  “Text”.

Track title, Artist name and Album title are shown on the display.

To return to the previous display, press  “Text” or  “Back”.

### Adjusting sound quality and volume balance

- 1 Press the “SETUP/ENTER” button to enter Set up menu mode.
- 2 Press the “<SELECT” or “TUNE>” button to change sound modes.  
(→P. 332)

#### ■ About iPod



- “Made for iPod” and “Made for iPhone” mean that an electronic accessory has been designed to connect specifically to iPod, or iPhone, respectively, and has been certified by the developer to meet Apple performance standards.
- Apple is not responsible for the operation of this device or its compliance with safety and regulatory standards. Please note that the use of this accessory with iPod or iPhone may affect wireless performance.
- iPhone, iPod, iPod classic, iPod nano and iPod touch are trademarks of Apple Inc., registered in the U.S. and other countries.

#### ■ iPod functions

- When an iPod is connected and the audio source is changed to iPod mode, the iPod will resume playing from the same point in which it was last used.
- Depending on the iPod that is connected to the system, certain functions may not be available. If a function is unavailable due to a malfunction (as opposed to a system specification), disconnecting the device and reconnecting it once again may resolve the problem.
- While connected to the system, the iPod cannot be operated with its own controls. It is necessary to use the controls of the vehicle’s audio system instead.
- When the battery level of an iPod is very low, the iPod may not operate. If so, charge the iPod before use.
- Supported models (→P. 352)

### ■ iPod problems

To resolve most problems encountered when using your iPod, disconnect your iPod from the vehicle iPod connection and reset it.

For instructions on how to reset your iPod, refer to your iPod Owner's Manual.

### ■ Display

→P. 341

### ■ Error messages

If an error message is displayed, refer to the following table and take the appropriate measures. If the problem is not rectified, take the vehicle to any authorized Toyota dealer or repairer, or another duly qualified and equipped professional.

Message	Cause/Correction procedures
"iPod error"	This indicates that the data in the iPod cannot be read.
"Error 3"	This indicates that the iPod may be malfunctioning.
"Error 4"	This indicates that an over current error has occurred.
"Error 5"	This indicates that an iPod communication error has occurred.
"Error 6"	This indicates that an authentication error has occurred.
"No songs"	This indicates that there is no music data in the iPod.
"No playlists"	This indicates that some available songs are not found in a selected playlist.
"Update your iPod"	This indicates that the version of the iPod is not compatible. Upgrade your iPod software to the latest version.

■ **Compatible models**

The following iPod®, iPod nano®, iPod classic®, iPod touch® and iPhone® devices can be used with this system.

● **Made for**

- iPod (5th generation)
- iPod touch (5th generation)
- iPod touch (4th generation)
- iPod touch (Late 2009)
- iPod touch (3rd generation)
- iPod touch (2nd generation)
- iPod touch (1st generation)
- iPod classic (Late 2009)
- iPod classic (2nd generation)
- iPod classic
- iPod nano (7th generation)
- iPod nano (6th generation)
- iPod nano (5th generation)
- iPod nano (4th generation)
- iPod nano (3rd generation)
- iPod nano (2nd generation)
- iPod nano (1st generation)
- iPhone 5s
- iPhone 5c
- iPhone 5
- iPhone 4S
- iPhone 4
- iPhone 3GS
- iPhone 3G
- iPhone

Depending on differences between models or software versions etc., some models might be incompatible with this system.

Items related to standards and limitations are as follows:

- Maximum number of lists in device: 9999
- Maximum number of songs in device: 65535
- Maximum number of songs per list: 65535

 WARNING■ **Caution while driving**

Do not connect iPod or operate the controls.

 NOTICE■ **To prevent damage to iPod**

- Do not leave the iPod in the vehicle. The temperature inside the vehicle may become high, resulting in damage to the iPod.
- Do not push down on or apply unnecessary pressure to the iPod while it is connected.
- Do not insert foreign objects into the port.

امداد خودرو فارما

تلفن شبانه روزی: ۰۲۱-۸۸۸۶۲۰۸۵

FarmaSOS.com

## Listening to a USB memory device

Connecting a USB memory device enables you to enjoy music from the vehicle speakers. Press the “MODE” button until “USB” is displayed.

### Connecting a USB memory

→P. 331

امداد خودرو فارما

تلفن شبانه روزی: ۰۲۱-۸۸۸۶۲۰۸۵

FarmaSOS.com

## Control panel

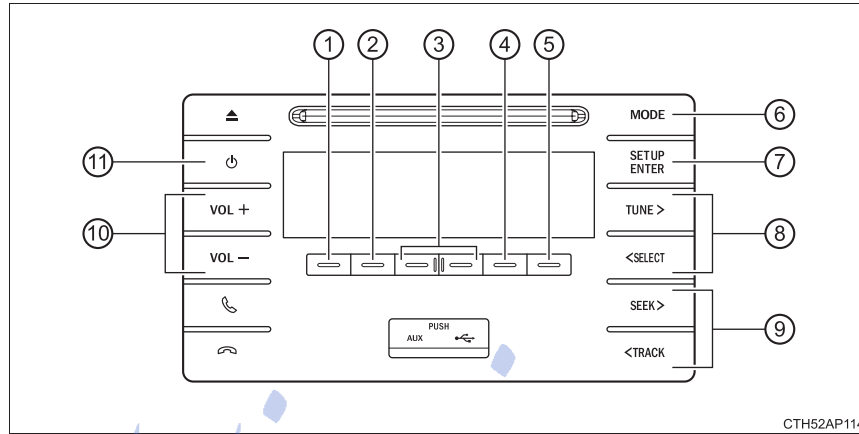

- ① Display text message
- ② Display folder lists
- ③ Select a folder
- ④ Repeat play
- ⑤ Random playback
- ⑥ Mode select button
- ⑦ Open the selected file
- ⑧ Select a file
- ⑨ Select a file, fast-forward or reverse
- ⑩ Volume
- ⑪ Power

### Selecting a folder

#### ■ Selecting folders one at a time

Press  “<” or  “>” to select the desired folder.

#### ■ Selecting a folder and file from a folder list

1 Press  “List”.

The folder list will be displayed.

2 Press the “<SELECT” or “TUNE>” button to select a folder or file.

3 Press the “SETUP/ENTER” button to open the selected file/folder.

To return to the previous display, press  “Back”.

#### ■ Returning to the first folder

Press and hold  “<” until you hear a beep.

### Selecting a file

Press the “<SELECT”, “TUNE>”, “<TRACK” or “SEEK>” button to select the desired file.

### Fast-forwarding and reversing a file

To fast-forward or reverse, press and hold the “SEEK>” or “<TRACK” button.

### Repeat play

Pressing  “RPT” changes the repeat playback mode in the following order:

File repeat → Folder repeat\* → Off.



\*: Not available when RDM (random playback) is selected

### Random playback

Pressing  “RDM” changes the random playback mode in the following order:

Folder random → Disc random → Off.







### Switching the display

Press  "Text".

Track title, Artist name and Album title (MP3 only) are displayed on the display.

To return to the previous display, press  "Text" or  "Back".

### ■ USB memory functions

- Depending on the USB memory that is connected to the system, the device itself may not be operable and certain functions may not be available. If the device is inoperable or a function is unavailable due to a malfunction (as opposed to a system specification), disconnecting the device and reconnecting it may resolve the problem.
- If the USB memory still does not begin operation after being disconnected and reconnected, format the device.

### ■ Display

→P. 341

### ■ Error messages

If an error message is displayed, refer to the following table and take the appropriate measures. If the problem is not rectified, take the vehicle to any authorized Toyota dealer or repairer, or another duly qualified and equipped professional.

Message	Cause/Correction procedures
"USB error"	This indicates that the data in the USB memory cannot be read.
"Error 3"	This indicates that the USB memory may be malfunctioning.
"Error 4"	This indicates that an over current error has occurred.
"Error 5"	This indicates that the USB memory communication error has occurred.
"No music"	This indicates that no MP3/WMA files are included on the USB memory device.

### ■ USB memory

#### ● Compatible devices

USB memory that can be used for MP3 and WMA playback

#### ● Compatible device formats

The following device formats can be used:

- USB communication formats: USB 2.0 FS (12 Mbps)
- File formats: FAT12/16/32 (Windows)
- Correspondence class: Mass storage class

MP3 and WMA files written in any format other than those listed above may not play correctly, and their file names and folder names may not be displayed correctly.

Items related to standards and limitations are as follows:

- Maximum directory hierarchy: 8 levels
- Maximum number of folders in a device: 999 (including the root)
- Maximum number of files in a device: 9999
- Maximum number of files per folder: 255

#### ● MP3 and WMA files

MP3 (MPEG Audio LAYER 3) is a standard audio compression format.

Files can be compressed to approximately 1/10 of their original size using MP3 compression.

WMA (Windows Media Audio) is a Microsoft audio compression format.

This format compresses audio data to a size smaller than that of the MP3 format.

There is a limit to the MP3 and WMA file standards that can be used and to the media/formats on which the files are recorded.

#### ● MP3 file compatibility

- Compatible standards  
MP3 (MPEG1 AUDIO LAYERII, III, MPEG2 AUDIO LAYERII, III, MPEG2.5)
- Compatible sampling frequencies  
MPEG1 AUDIO LAYERII, III: 32, 44.1, 48 (kHz)  
MPEG2 AUDIO LAYERII, III: 16, 22.05, 24 (kHz)  
MPEG2.5: 8, 11.025, 12 (kHz)
- Compatible bit rates (compatible with VBR)  
MPEG1 AUDIO LAYERII, III: 32-320 (kbps)  
MPEG2 AUDIO LAYERII, III: 8-160 (kbps)  
MPEG2.5: 8-160 (kbps)
- Compatible channel modes: stereo, joint stereo, dual channel and monaural

- **WMA file compatibility**
  - Compatible standards  
WMA Ver. 7, 8, 9
  - Compatible sampling frequencies  
HIGH PROFILE 32, 44.1, 48 (kHz)
  - Compatible bit rates  
HIGH PROFILE 32-320 (kbps, CBR)
- **File names**

The only files that can be recognized as MP3/WMA and played are those with the extension .mp3 or .wma.
- **ID3 and WMA tags**

ID3 tags can be added to MP3 files, making it possible to record the track title, artist name, etc.

The system is compatible with ID3 Ver. 1.0, 1.1, and Ver. 2.2, 2.3, 2.4 ID3 tags. (The number of characters is based on ID3 Ver. 1.0 and 1.1.)

WMA tags can be added to WMA files, making it possible to record the track title and artist name in the same way as with ID3 tags.
- **MP3 and WMA playback**
  - When a device containing MP3 or WMA files is connected, all files in the USB memory are checked. Once the file check is finished, the first MP3 or WMA file is played. To make the file check finish more quickly, we recommend that you do not include any files other than MP3 or WMA files or create any unnecessary folders.
  - When the USB memory is connected and the audio source is changed to USB memory mode, the USB memory will start playing the first file in the first folder. If the same device is removed and reinserted (and the contents have not been changed), the USB memory will resume play from the same point in which it was last used.
- **Extensions**

If the file extensions .mp3 and .wma are used for files other than MP3 and WMA files, they will be skipped (not played).
- **Playback**
  - To play MP3 files with steady sound quality, we recommend a fixed bit rate of at least 128 kbps and a sampling frequency of 44.1 kHz.
  - There is a wide variety of freeware and other encoding software for MP3 and WMA files on the market, and depending on the status of the encoding and the file format, poor sound quality or noise at the start of playback may result. In some cases, playback may not be possible at all.
  - Microsoft, Windows, and Windows Media are registered trademarks of Microsoft Corporation in the U.S.A. and other countries.

 WARNING

■ **Caution while driving**

Do not connect USB memory or operate the controls.

 NOTICE

■ **To prevent damage to USB memory**

- Do not leave USB memory in the vehicle. The temperature inside the vehicle may become high, resulting in damage to the device.
- Do not push down on or apply unnecessary pressure to the USB memory while it is connected.
- Do not insert foreign objects into the port.

امداد خودرو فارما

تلفن شبانه روزی: ۰۲۱-۸۸۸۶۲۰۸۵

FarmaSOS.com

## Using the AUX port

This port can be used to connect a portable audio device and listen to it through the vehicle's speakers. Press the "MODE" button until "AUX" is displayed.

### Connecting a portable player

→P. 331

#### ■ Operating portable audio devices connected to the audio system

The volume can be adjusted using the vehicle's audio controls. All other adjustments must be made on the portable audio device itself.

#### ■ When using a portable audio device connected to the power outlet

Noise may occur during playback. Use the power source of the portable audio device.

تلفن شبانه روزی: ۰۲۱-۸۸۶۲۰۸۵

FarmaSOS.com

## Bluetooth® audio/phone

The following can be performed using Bluetooth® wireless communication:

### ■ Bluetooth® audio

The Bluetooth® audio system enables you to enjoy music on a portable player from the vehicle speakers via wireless communication.

This audio system supports Bluetooth®, a wireless data system capable of playing portable audio music without cables. If your portable player does not support Bluetooth®, the Bluetooth® audio system cannot be used.

### ■ Bluetooth® phone (hands-free phone system)

This system supports Bluetooth®, which allows you to make or receive calls without using cables to connect a cellular phone to the system, and without operating the cellular phone.

تلفن شبانه روزی: ۰۲۱-۸۸۶۲۰۸۵

FarmaSOS.com

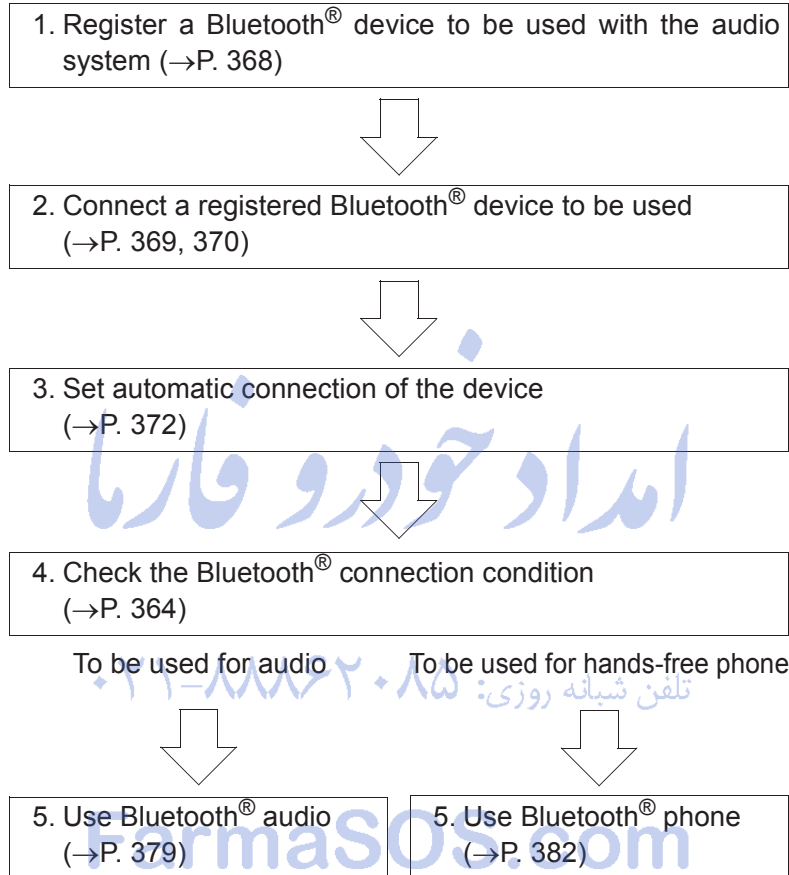
**Device registration/connection flow**

**Audio unit**

- ① Bluetooth® connection status  
If “BT” is not displayed, the Bluetooth® audio/phone cannot be used.
- ② Display  
A message, name, number, etc. is displayed.  
Lower-case characters and special characters cannot be displayed.
- ③ Displays the set up menu/inputs the selected item
- ④ Select items such as menu and number
- ⑤ Off-hook switch  
Turns the hands-free system on/starts a call
- ⑥ On-hook switch  
Turns the hands-free system off/ends a call/refuses a call
- ⑦ Displays information that is too long to be displayed at one time on the display (press and hold)
- ⑧ Select speed dials

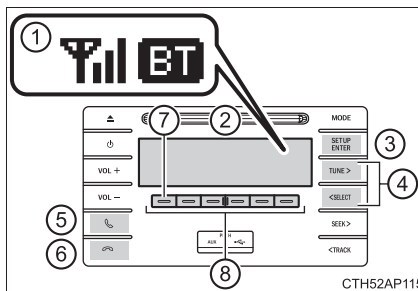

**Microphone**

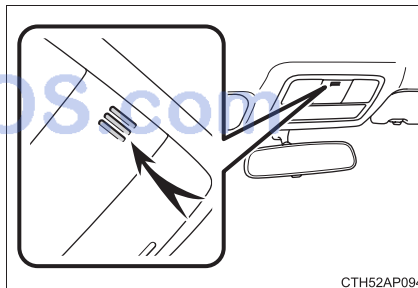



### Menu list of the Bluetooth® audio/phone

To enter a menu, press the “SETUP/ENTER” button and navigate menus by using the “<SELECT”, “TUNE>” and “SETUP/ENTER” buttons:

First menu	Second menu	Third menu	Operation details	
“Bluetooth*”	“Pairing”	-	Register a Bluetooth® device	
	“List phone”	-	List the registered cellular phones	
	“List audio”	-	List the registered portable players	
	“Passkey”	-	Change the passkey	
	“BT power”	-	Set automatic connection of the device on or off	
	“Bluetooth* info”	“Device Name” “Device Address”	-	Display the device status
	“Display setting”	-	Set the automatic connection confirmation display on or off	
“Reset”	-	Initialize the settings		

First menu	Second menu	Third menu	Operation details
"PHONE" or "TEL"	"Phonebook"	"Add contacts"	Add a new number
		"Add SD"	Register a speed dial
		"Delete call history"	Delete a number stored in the call history
		"Delete contacts"	Delete a number stored in the phonebook
		"Delete other PB"	Delete a phonebook's data
	"HF sound setting"	"Call volume"	Set call volume
		"Ringtone volume"	Set ringtone volume
		"Ringtone"	Set the ringtone
	"Transfer history"	-	Transfer the call histories

\*: Bluetooth is a registered trademark of Bluetooth SIG, Inc. تلفن شماره روزی

■ **Bluetooth® audio/phone system functions**

Depending on the Bluetooth® device, certain functions may not be available.

FarmaSOS.com

## Using the steering wheel switches\*

The steering wheel switches can be used to operate a connected cellular phone or portable digital audio player (portable player).

### Operating a Bluetooth® phone using the steering wheel switches

- ① Volume  
The voice guidance volume cannot be adjusted using these buttons.
- ② Off-hook switch  
Turns the hands-free system on/starts a call
- ③ On-hook switch  
Turns the hands-free system off/ends a call/refuses a call
- ④ Talk switch (if equipped)  
A message will be displayed.

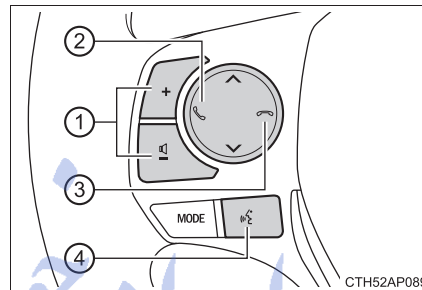

5

Audio system

تلفن شبانه روزی: ۰۲۱-۸۸۶۲۰۸۵

FarmaSOS.com

\*: If equipped

## Registering a Bluetooth® device

**Before using the Bluetooth® audio/phone, it is necessary to register a Bluetooth® device in the system. You can register up to 5 Bluetooth® devices.**

### How to register a Bluetooth® device

- 1 Press the “SETUP/ENTER” button and select “Bluetooth\*” using the “<SELECT” or “TUNE>” button.

\*: Bluetooth is a registered trademark of Bluetooth SIG, Inc.

- 2 Press the “SETUP/ENTER” button and select “Pairing” using the “<SELECT” or “TUNE>” button.

A passkey will be displayed.

- 3 SSP (Secure Simple Pairing) incompatible Bluetooth® devices:  
Input the passkey into the device.  
SSP (Secure Simple Pairing) compatible Bluetooth® devices:  
Select “Yes” to register the device. Depending on the type of device, it may register automatically.

If a Bluetooth® device has both music player and cellular phone functions, both functions will be registered at the same time. When deleting the device, both functions will be deleted at the same time.

If the off-hook switch is pressed and the “PHONE” or “TEL” mode is entered when no phones have been registered, the registration screen will be automatically displayed.

## Using the "SET UP" menu ("Bluetooth\*" menu)

Registering a Bluetooth® device in the system allows the system to function. The following functions can be used for registered devices:

\*: Bluetooth is a registered trademark of Bluetooth SIG, Inc.

### Registering a portable player

Select "Pairing" using the "<SELECT", "TUNE>" and "SETUP/ENTER" buttons (→P. 365), and perform the procedure for registering a portable player. (→P. 368)

### Listing the registered cellular phones

Select "List phone" using the "<SELECT", "TUNE>" and "SETUP/ENTER" buttons. (→P. 365) The list of registered cellular phones will be displayed.

- Connecting the registered cellular phone to the audio system

- 1 Select the name of the cellular phone to be connected using the "<SELECT", "TUNE>" and "SETUP/ENTER" buttons.
- 2 Select "Select" using the "<SELECT", "TUNE>" and "SETUP/ENTER" buttons.

- Deleting a registered cellular phone

- 1 Select the name of the cellular phone to be deleted using the "<SELECT", "TUNE>" and "SETUP/ENTER" buttons.
- 2 Select "Delete" using the "<SELECT", "TUNE>" and "SETUP/ENTER" buttons.
- 3 Press  "Yes".

- Disconnecting the registered cellular phone from the audio system
  - 1 Select the name of the cellular to be disconnected using the "<SELECT", "TUNE>" and "SETUP/ENTER" buttons.
  - 2 Select "Disconnect" using the "<SELECT", "TUNE>" and "SETUP/ENTER" buttons.
  - 3 Press  "Yes".

#### Listing the registered portable players

Select "List audio" using the "<SELECT", "TUNE>" and "SETUP/ENTER" buttons. (→P. 365) The list of registered portable players will be displayed.

- Connecting the registered portable player to the audio system
  - 1 Select the name of the portable player to be connected using the "<SELECT", "TUNE>" and "SETUP/ENTER" buttons.
  - 2 Select "Select" using the "<SELECT", "TUNE>" and "SETUP/ENTER" buttons.
- Deleting the registered portable player
  - 1 Select the name of the portable player to be deleted using the "<SELECT", "TUNE>" and "SETUP/ENTER" buttons.
  - 2 Select "Delete" using the "<SELECT", "TUNE>" and "SETUP/ENTER" buttons.
  - 3 Press  "Yes".

FarmaSOS.com

- Disconnecting the registered portable player from the audio system
  - 1 Select the name of the portable player to be disconnected using the "<SELECT", "TUNE>" and "SETUP/ENTER" buttons.
  - 2 Select "Disconnect" using the "<SELECT", "TUNE>" and "SETUP/ENTER" buttons.
  - 3 Press  "Yes".
- Selecting the connection method
  - 1 Select the name of the desired portable player using the "<SELECT", "TUNE>" and "SETUP/ENTER" buttons.
  - 2 Select "Connection method" using the "<SELECT", "TUNE>" and "SETUP/ENTER" buttons.
  - 3 Select "From vehicle" or "From audio" using the "<SELECT", "TUNE>" and "SETUP/ENTER" buttons.

#### Changing the passkey

- 1 Select "Passkey" using the "<SELECT", "TUNE>" and "SETUP/ENTER" buttons. (→P. 365)
- 2 Input a 4 to 8-digit passkey using the "<SELECT", "TUNE>" and "SETUP/ENTER" buttons.  
Input the number 1 digit at a time.
- 3 When the entire number to be registered as a passkey has been input, press  "Enter".  
If the passkey to be registered has 8 digits, pressing  "Enter" is not necessary.

**Setting automatic connection of the device on or off**

If "BT power" is set to on, the registered device will be connected automatically when the engine switch is turned to the "ACC" position (vehicles without a smart entry & start system) or ACCESSORY mode (vehicles with a smart entry & start system).

- 1 Select "BT power" using the "<SELECT", "TUNE>" and "SETUP/ENTER" buttons. (→P. 365)
- 2 Select "On" or "Off" using the "SETUP/ENTER" button.

**Displaying the device status**

Select "Bluetooth\* info" using the "<SELECT", "TUNE>" and "SETUP/ENTER" buttons. (→P. 365)

\*: Bluetooth is a registered trademark of Bluetooth SIG, Inc.

**● Displaying the device name**

Select "Device name" using the "<SELECT", "TUNE>" and "SETUP/ENTER" buttons.

**● Displaying the device address**

Select "Device address" using the "<SELECT", "TUNE>" and "SETUP/ENTER" buttons.

**Setting the automatic connection confirmation display to on or off**

If the "Display setting" is set to on, the portable player connection status will be displayed when the engine switch is turned to the "ACC" or "ON" position (vehicles without a smart entry & start system) or ACCESSORY or IGNITION ON mode (vehicles with a smart entry & start system).

- 1 Select "Display setting" using the "<SELECT", "TUNE>" and "SETUP/ENTER" buttons. (→P. 365)
- 2 Select "On" or "Off" using the "SETUP/ENTER" button.



### Initialization

Select "Reset" using the "<SELECT", "TUNE>" and "SETUP/ENTER" buttons. (→P. 365)

- Initializing the sound settings

Select "Sound settings" using the "<SELECT", "TUNE>" and "SETUP/ENTER" buttons and press  "Yes".

For details about sound settings: →P. 377

- Initializing the device information

Select "Car Device Info" using the "<SELECT", "TUNE>" and "SETUP/ENTER" buttons and press  "Yes".

The user set passkey and automatic confirmation display will be returned to their default settings.

- Initializing all the settings

Select "Reset all" using the "<SELECT", "TUNE>" and "SETUP/ENTER" buttons and press  "Yes".

تلفن شبانه روزی: ۰۲۱-۸۸۶۲۰۸۵

FarmaSOS.com

## Using the "SET UP" menu ("Phone" menu)

### Adding a new phone number

Select "Add contacts" using the "<SELECT", "TUNE>" and "SETUP/ENTER" buttons. (→P. 365)

- Transferring all contacts from the cellular phone

Select "Overwrite all" using the "<SELECT", "TUNE>" and "SETUP/ENTER" buttons and press  "Yes".

- Transferring one contact from the cellular phone

Select "Add contact" using the "<SELECT", "TUNE>" and "SETUP/ENTER" buttons and press  "Yes".

### Setting speed dials

- 1 Select "Add SD" using the "<SELECT", "TUNE>" and "SETUP/ENTER" buttons. (→P. 365)
- 2 Select the desired data using the "<SELECT", "TUNE>" and "SETUP/ENTER" buttons.
- 3 Press and hold the desired preset button.  
For details about setting speed dials from the call history: →P. 383  
For details about deleting speed dials: →P. 382



FarmaSOS.com

### Deleting call histories

Select "Delete call history" using the "<SELECT", "TUNE>" and "SETUP/ENTER" buttons. (→P. 365)

#### ● Deleting outgoing call history

- 1 Select "Outgoing calls" using the "<SELECT", "TUNE>" and "SETUP/ENTER" buttons.
- 2 Select the desired phone number using the "<SELECT", "TUNE>" and "SETUP/ENTER" buttons and press  "Yes".

To delete all outgoing call history data, press  "All" and then press  "Yes".

#### ● Deleting incoming call history

- 1 Select "Incoming calls" using the "<SELECT", "TUNE>" and "SETUP/ENTER" buttons.
- 2 Select the desired phone number using the "<SELECT", "TUNE>" and "SETUP/ENTER" buttons and press  "Yes".

To delete all incoming call history data, press  "All" and then press  "Yes".

FarmaSOS.com

● Deleting missed call history

1 Select "Missed calls" using the "<SELECT", "TUNE>" and "SETUP/ENTER" buttons.

2 Select the desired phone number using the "<SELECT", "TUNE>" and "SETUP/ENTER" buttons and press  "Yes".

To delete all missed call history data, press  "All" and then press  "Yes".

● Deleting a number from all call histories (Outgoing calls, Incoming calls and Missed calls)

1 Select "All calls" using the "<SELECT", "TUNE>" and "SETUP/ENTER" buttons.

2 Select the desired phone number using the "<SELECT", "TUNE>" and "SETUP/ENTER" buttons and press  "Yes".

To delete all of the call history data, press  "All" and then press  "Yes".

تلفن شبانه روزی: ۰۲۱-۸۸۸۶۲۰۸۵

FarmaSOS.com

**Deleting a registered phone number**

- 1 Select "Delete contacts" using the "<SELECT", "TUNE>" and "SETUP/ENTER" buttons. (→P. 365)
- 2 Select the desired phone number using the "<SELECT", "TUNE>" and "SETUP/ENTER" buttons and press  "Yes".

To delete all of the registered phone numbers, Press  "All" and then press  "Yes".

Press  "A-Z" to display the registered names in alphabetical order of the initial.

**Deleting another cellular phone's phonebook**

- 1 Select "Delete other PB" using the "<SELECT", "TUNE>" and "SETUP/ENTER" buttons. (→P. 365)
- 2 Select the desired phonebook using the "<SELECT", "TUNE>" and "SETUP/ENTER" buttons and press  "Yes".

**Setting call volume**

- 1 Select "Call volume" using the "<SELECT", "TUNE>" and "SETUP/ENTER" buttons. (→P. 365)
- 2 Change the call volume.

To decrease the volume: Press the "<SELECT" button.

To increase the volume: Press the "TUNE>" button.

To set the volume, press  "Back".

### Setting ringtone volume

- 1 Select "Ringtone volume" using the "<SELECT", "TUNE>" and "SETUP/ENTER" buttons. (→P. 365)
- 2 Change the ringtone volume.  
To decrease the volume: Press the "<SELECT" button.  
To increase the volume: Press the "TUNE>" button.  
To set the volume, press  "Back".

### Setting ringtone

- 1 Select "Ringtone" using the "<SELECT", "TUNE>" and "SETUP/ENTER" buttons. (→P. 365)
- 2 Using the "<SELECT" or "TUNE>" button, select a ringtone (1 - 3).  
To set the selected ringtone, press  "Back".

### Transferring call histories

Select "Transfer history" using the "<SELECT", "TUNE>" and "SETUP/ENTER" buttons and press  "Yes".

#### ■ Phone number

Up to 1000 names can be stored.

#### ■ Call history

Up to 10 numbers can be stored in each of the outgoing, incoming and missed call history memories.

#### ■ Limitation of number of digits

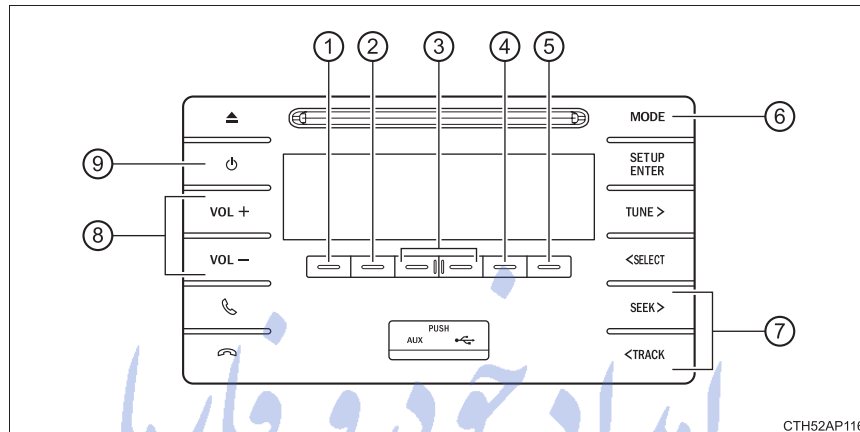

A phone number that exceeds 24 digits cannot be registered.

## Operating a Bluetooth® enabled portable player



- |                        |   |
|------------------------|---|
| ① Display text message | ⑥ Playback                                |
| ② Playback/pause       | ⑦ Select a track, fast-forward or reverse |
| ③ Select an album      | ⑧ Volume                                  |
| ④ Repeat play          | ⑨ Power                                   |
| ⑤ Random playback      |   |

#### Selecting an album

Press  “<” or  “>” to select the desired album.

#### Selecting a track

Press the “SEEK>” or “<TRACK” button to select the desired track.

#### Playing and pausing a track

Press  “▶||” to play or pause a track.

#### Fast-forwarding and reversing a track

To fast-forward or reverse, press and hold the “SEEK>” or “<TRACK” button.

#### Random playback

Pressing  “RDM” changes the random playback mode in the following order:

Album random → All track random → Off

تلفن شبانه روزی: ۰۲۱-۸۸۸۶۲۰۸۵

FarmaSOS.com



**Repeat play**



Pressing  "RPT" changes the repeat play mode in the following order:

Track repeat → Album repeat → Off

**Switching the display**

Press  "Text".

Track title and artist name are displayed on the display.

To return to the previous display, press  "Text" or  "Back".

**Bluetooth® audio system functions**

Depending on the portable player that is connected to the system, certain functions may not be available.

امداد خودرو فارما

تلفن شبانه روزی: ۰۲۱-۸۸۸۶۲۰۸۵

FarmaSOS.com

## Making a phone call

To enter the “PHONE” or “TEL” mode, press the off-hook switch.

### Dialing by selecting a name



- 1 Select “Phonebook” using the “<SELECT”, “TUNE>” and “SETUP/ENTER” buttons.
- 2 Select the desired name using the “<SELECT”, “TUNE>” and “SETUP/ENTER” buttons and press the off-hook switch.

By pressing  “Add S. Dial” and then one of the speed dial buttons while the desired name is selected, the selected item can be registered as a speed dial.

Press  “A-Z” to display the registered names in alphabetical order of the initial.

### Speed dialing

- 1 Select “Speed dials” using the “<SELECT”, “TUNE>” and “SETUP/ENTER” buttons.
- 2 Press the desired preset button and press the off-hook switch.

To delete a registered speed dial, after selecting the desired preset button press  “Delete” and then press  “Yes”.

### Dialing by entering the number

- 1 Select “Dial by number” using the “<SELECT”, “TUNE>” and “SETUP/ENTER” buttons.
- 2 Enter the phone number and press the off-hook switch.

**Dialing from call histories**



- 1 Select “All calls”, “Missed calls”, “Incoming calls” or “Outgoing calls” using the “<SELECT”, “TUNE>” and “SETUP/ENTER” buttons.
- 2 Select the desired number using the “<SELECT”, “TUNE>” and “SETUP/ENTER” buttons and press the off-hook switch.

The following operations can be performed:

- Registering a number as a speed dial

Press  “Add S. Dial” and then press the desired preset button.

- Deleting the selected number

Press  “Delete” and press  “Yes”.

امداد خودرو فارما

تلفن شبانه روزی: ۰۲۱-۸۸۸۶۲۰۸۵

FarmaSOS.com

## Receiving a phone call

### Answering the phone

Press the off-hook switch.

### Refusing a call

Press the on-hook switch.

### Receiving a call when on another call

Press the off-hook switch.

Pressing the off-hook switch again returns you to the previous call.

### Adjusting the ringtone volume when receiving a call

Change the ringtone volume using the “VOL-” or “VOL+” button.

To decrease the volume: Press the “VOL-” button.

To increase the volume: Press the “VOL+” button.

تلفن شبانه روزی: ۰۲۱-۸۸۸۶۲۰۸۵

FarmaSOS.com

## Speaking on the phone

### Transferring a call

A call can be transferred between the cellular phone and system while dialing, receiving a call, or during a call. Use one of the following methods:

- a. Operate the cellular phone.

Refer to the manual that comes with the cellular phone for the operation of the phone.

- b. Press  \* "Phone".



\*: This operation can be performed only when transferring a call from the cellular phone to the system during a call.

### Muting your voice

Press  "Mute".

### Inputting digits

Press  "0 - 9" and use the "<SELECT", "TUNE>" and "SETUP/ENTER" buttons to input the desired digits.

- To send the input digits, press  "Send".
- When finished, press  "Wait" to return to the previous screen.

### Setting call volume

Change the call volume using the "VOL-" or "VOL+" button.

To decrease the volume: Press the "VOL-" button.

To increase the volume: Press the "VOL+" button.

■ **When talking on the phone**

- Do not talk at the same time as the other party.
- Keep the volume of the received voice down. Otherwise, voice echo will increase.

■ **Automatic volume adjustment**

When vehicle speed is 80 km/h (50 mph) or more, the volume automatically increases. The volume returns to the previous volume setting when vehicle speed drops to 70 km/h (43 mph) or less.

■ **Phone call system functions**

Depending on the cellular phone, certain functions may not be available.

■ **Situations where the system may not recognize your voice**

- When driving on a rough road
- When driving at high speeds
- When air is blowing out of the vents onto the microphone
- When the air conditioning fan emits a loud noise

امداد خودرو فارما  
تلفن شبانه روزی: ۰۲۱-۸۸۸۶۲۰۸۵

FarmaSOS.com

## Bluetooth®

### ■ When using the Bluetooth® audio/Phone

- In the following situations, the system may not function.
  - The portable player does not support Bluetooth®
  - The cellular phone is located outside the service area
  - The Bluetooth® device is switched off
  - The Bluetooth® device has a low battery
  - The Bluetooth® device is not connected to the system
  - The Bluetooth® device is behind the seat or in the glove box or console box, or is touching or covered by metal objects
- There may be a delay if a cellular phone connection is made during Bluetooth® audio playback.
- Depending on the type of portable audio player that is connected to the system, operation may differ slightly and certain functions may not be available.

### ■ When transferring ownership of the vehicle

Be sure to initialize the system to prevent personal data from being improperly accessed. (→P. 373)

### ■ About Bluetooth®

Bluetooth is a registered trademark of Bluetooth SIG, Inc.



### ■ Compatible models

- Bluetooth® specifications:
  - Ver. 1.1, or higher (recommended: Ver. 2.1 + EDR or higher)
- Following Profiles:
  - A2DP (Advanced Audio Distribution Profile) Ver. 1.0, or higher (recommended: Ver. 1.2 or higher)
  - AVRCP (Audio/Video Remote Control Profile) Ver. 1.0 or higher (recommended: Ver. 1.3 or higher)

Portable players must correspond to the above specifications in order to be connected to the Bluetooth® audio system. However, please note that some functions may be limited depending on the type of portable player.

- Cellular phone
  - HFP (Hands Free Profile) Ver. 1.0 or higher (recommended: Ver. 1.5)
  - OPP (Object Push Profile) Ver. 1.1
  - PBAP (Phone Book Access Profile) Ver. 1.0

## ■ Certification

	<p>Access to <a href="http://www.ptc.panasonic.eu/">http://www.ptc.panasonic.eu/</a>, enter the below Model No. into the keyword search box, you can download the latest "DECLARATION of CONFORMITY" (DoC).</p> <p>Model No.AT1601</p>
<p>Hereby, Panasonic, declares that this AT1601 is in compliance with the essential requirements and other relevant provisions of Directive 1999/5/EC.</p>	
<p>С настоящето, Panasonic, декларира, че AT1601 е в съответствие със съществените изисквания и другите приложими разпоредби на Директива 1999/5/EC.</p>	
<p>Panasonic tímto prohlašuje, že tento AT1601 je ve shodě se základními požadavky a dalšími příslušnými ustanoveními směrnice 1999/5/ES.</p>	
<p>Undertegnede Panasonic erklærer herved, at følgende udstyr AT1601 overholder de væsentlige krav og øvrige relevante krav i direktiv 1999/5/EF.</p>	
<p>Hierbij verklaart Panasonic dat het toestel AT1601 in overeenstemming is met de essentiële eisen en de andere relevante bepalingen van richtlijn 1999/5/EG.</p>	
<p>Käesolevaga kinnitab Panasonic seadme AT1601 vastavust direktiivi 1999/5/EÜ põhinõuetele ja nimetatud direktiivist tulenevatele teistele asjakohastele sätetele.</p>	
<p>Panasonic vakuuttaa täten että AT1601 tyyppinen laite on direktiivin 1999/5/EY oleellisten vaatimusten ja sitä koskevien direktiivin muiden ehtojen mukainen.</p>	
<p>Par la présente Panasonic déclare que l'appareil AT1601 est conforme aux exigences essentielles et aux autres dispositions pertinentes de la directive 1999/5/CE.</p>	
<p>Hiermit erklärt Panasonic, dass sich das Gerät AT1601 in Übereinstimmung mit den grundlegenden Anforderungen und den übrigen einschlägigen Bestimmungen der Richtlinie 1999/5/EG befindet.</p>	
<p>ΜΕ ΤΗΝ ΠΑΡΟΥΣΑ Panasonic ΔΗΛΩΝΕΙ ΟΤΙ ΑΤ1601 ΣΥΜΜΟΡΦΩΝΕΤΑΙ ΠΡΟΣ ΤΙΣ ΟΥΣΙΩΔΕΙΣ ΑΠΑΙΤΗΣΕΙΣ ΚΑΙ ΤΙΣ ΛΟΙΠΕΣ ΣΧΕΤΙΚΕΣ ΔΙΑΤΑΞΕΙΣ ΤΗΣ ΟΔΗΓΙΑΣ 1999/5/ΕΚ.</p>	
<p>Alulírott, Panasonic nyilatkozom, hogy a AT1601 megfelel a vonatkozó alapvető követelményeknek és az 1999/5/EC irányelv egyéb előírásainak.</p>	
<p>Con la presente Panasonic dichiara che questo AT1601 è conforme ai requisiti essenziali ed alle altre disposizioni pertinenti stabilite dalla direttiva 1999/5/CE.</p>	



Ar šo Panasonic deklarē, ka AT1601 atbilst Direktīvas 1999/5/EK būtiskajām prasībām un citiem ar to saistītajiem noteikumiem.
Šīuo Panasonic deklaruoja, kad šis AT1601 atitinka esminius reikalavimus ir kitas 1999/5/EB Direktyvos nuostatas.
Hawnhekk, Panasonic, jiddkjara li dan AT1601 jikkonforma mal-ftġġijiet essenzjali u ma provvediment i oħrajn relevanti li hemm fid-Direttiva 1999/5/EC.
Niniejszym Panasonic oświadcza, że AT1601 jest zgodny z zasadniczymi wymogami oraz pozostałymi stosownymi postanowieniami Dyrektywy 1999/5/EC.
Panasonic declara que este AT1601 está conforme com os requisitos essenciais e outras disposições da Directiva 1999/5/CE.
Prin prezenta, Panasonic, declară că aparatul AT1601 este în conformitate cu cerințele esențiale și cu alte prevederi pertinente ale Directivei 1999/5/CE.
Panasonic týmto vyhlasuje, že AT1601 spĺna základné požiadavky a všetky príslušné ustanovenia Smernice 1999/5/ES.
Panasonic izjavlja, da je ta AT1601 v skladu z bistvenimi zahtevami in ostalimi relevantnimi določili direktive 1999/5/ES.
Por medio de la presente Panasonic declara que el AT1601 cumple con los requisitos esenciales y cualesquiera otras disposiciones aplicables o exigibles de la Directiva 1999/5/CE.
Härmed intygar Panasonic att denna AT1601 står i överensstämmelse med de väsentliga egenskapskrav och övriga relevanta bestämmelser som framgår av direktiv 1999/5/EG.
Hér með lýsir Panasonic yfir því að AT1601 er í samræmi við grunnkröfur og aðrar kröfur, sem gerðar eru í tilskipun 1999/5/EC.
Panasonic erklærer herved at utstyret AT1601 er i samsvar med de grunnleggende krav og øvrige relevante krav i direktiv 1999/5/EF.
Ovim Panasonic, izjavljuje da je AT1601 u skladu s bitnim zahtjevima i drugim relevantnim odredbama Direktive 1999/5/EC.
Ovim, Panasonic, deklarirše da je AT1601 u skladu sa osnovnim zahtjevima i ostalim relevantnim odredbama Direktive 1999/5/EC.

5

Audio system

 **WARNING****■ While driving**

Do not operate the portable audio player, cellular phone or connect a device to the Bluetooth® system.

**■ Caution regarding interference with electronic devices**

- Your audio unit is fitted with Bluetooth® antennas. People with implantable cardiac pacemakers, cardiac resynchronization therapy-pacemakers or implantable cardioverter defibrillators should maintain a reasonable distance between themselves and the Bluetooth® antennas. The radio waves may affect the operation of such devices.
- Before using Bluetooth® devices, users of any electrical medical device other than implantable cardiac pacemakers, cardiac resynchronization therapy-pacemakers or implantable cardioverter defibrillators should consult the manufacturer of the device for information about its operation under the influence of radio waves. Radio waves could have unexpected effects on the operation of such medical devices.

 **NOTICE****■ When leaving the vehicle**

Do not leave your portable audio player or cellular phone in the vehicle. The inside of the vehicle may become hot, causing damage to the portable audio player or cellular phone.

FarmaSOS.com

## Interior features

## 6

**6-1. Using the air conditioning system and defogger**

Manual air conditioning system .....	392
Automatic air conditioning system .....	399
Power heater .....	409
Seat heaters .....	411

**6-2. Using the interior lights**

Interior lights list.....	413
• Front interior light/ personal lights .....	414
• Vanity lights .....	414
• Rear interior light .....	415

**6-3. Using the storage features**

List of storage features .....	416
• Glove box .....	417
• Console box .....	417
• Bottle holders .....	418
• Cup holders .....	419
• Auxiliary boxes .....	420
Trunk features.....	422

**6-4. Other interior features**

Other interior features.....	423
• Sun visors.....	423
• Vanity mirrors .....	423
• Clock .....	423
• Power outlets.....	424
• Armrest.....	425
• Coat hook .....	425
• Assist grips .....	426

## Manual air conditioning system\*

### Air conditioning controls

► Type A

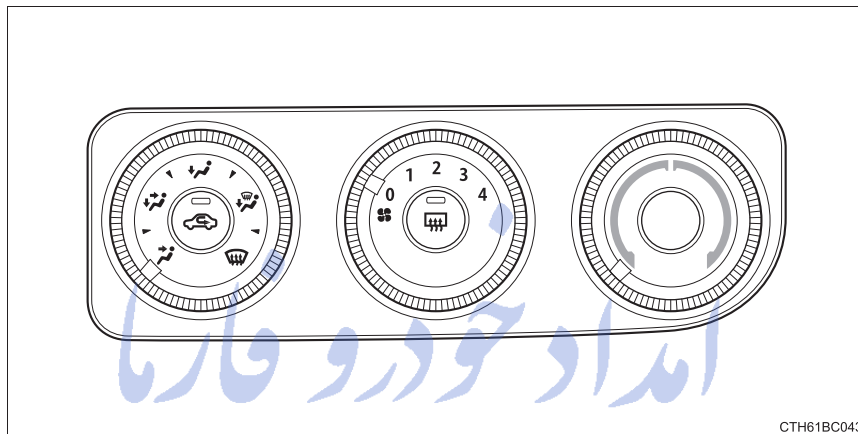

► Type B

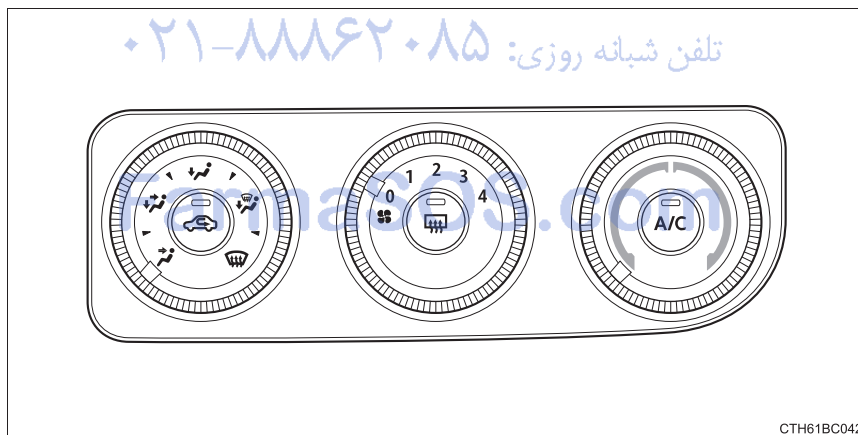

\*: If equipped

### ■ Adjusting the temperature setting

- ▶ Vehicles without the  button

To adjust the temperature setting, turn the temperature control dial clockwise to increase the temperature.

- ▶ Vehicles with the  button

To adjust the temperature setting, turn the temperature control dial clockwise (warm) or counterclockwise (cool).

If  is not pressed, the system will blow ambient temperature air or heated air.

### ■ Fan speed setting

To adjust the fan speed, turn the fan speed control dial clockwise (increase) or counterclockwise (decrease).

Turning the dial to "0" turns off the fan.

### ■ Change the airflow mode

To select the air outlets, turn the  dial to the desired position.

FarmaSOS.com

### Other functions

#### ■ Switching between outside air and recirculated air modes

Press  .

The mode switches between outside air mode (indicator off) and recirculated air mode (indicator on) each time  is pressed.



#### ■ Defogging the windshield

Defoggers are used to defog the windshield and front side windows.

Set the air outlet selector dial to the  position.

Set the outside/recirculated air mode button to outside air mode if the recirculated air mode is used. (It may switch automatically.)

To defog the windshield and the side windows early, turn the air flow and temperature up.

Vehicles with the  button: If the dehumidification function is not operating, press  to operate the dehumidification function.

#### ■ Defogging the rear window and outside rear view mirrors (if equipped)

Defogger(s) are used to defog the rear window, and to remove raindrops, dew and frost from the outside rear view mirrors (if equipped).

Press  .

Vehicles with timer: The defogger(s) will automatically turn off after a period of time.

### ■ Windshield wiper de-icer (if equipped)

This feature is used to prevent ice from building up on the windshield and wiper blades.

Press the switch to turn the system on/off.

The indicator comes on when the windshield wiper de-icer is on.

The windshield de-icer will automatically turn off after a period of time.

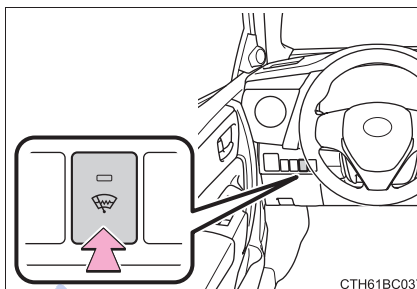

### Air outlets

#### ■ Location of air outlets

The air outlets and air volume changes according to the selected airflow mode.

← : Some models

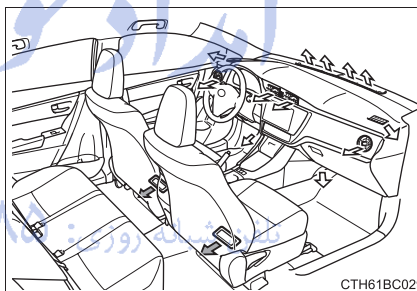

#### ■ Adjusting the position of and opening and closing the air outlets

##### ► Front center outlets

- ① Direct air flow to the left or right, up or down.
- ② Turn the knob up to open the vent and down to close the vent.

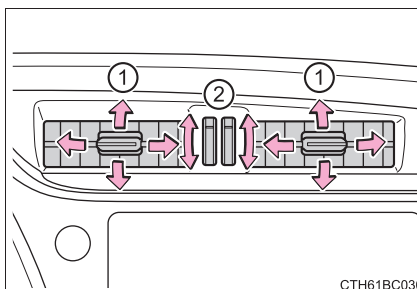

► Front side outlets



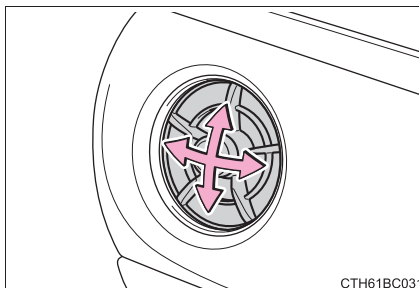

Direct air flow to the left or right, up or down.

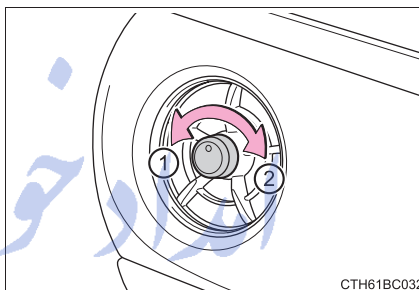

- ① Open the vent
- ② Close the vent





■ Fogging up of the windows

- Vehicles with the  button: The windows will easily fog up when the humidity in the vehicle is high. Turning  on will dehumidify the air from the outlets and defog the windshield effectively.
- Vehicles with the  button: If you turn  off, the windows may fog up more easily.
- The windows may fog up if the recirculated air mode is used.

■ Outside/recirculated air mode

When driving on dusty roads such as tunnels or in heavy traffic, set the outside/recirculated air mode button to the recirculated air mode. This is effective in preventing outside air from entering the vehicle interior. During cooling operation, setting the recirculated air mode will also cool the vehicle interior effectively.

■ When the outside temperature is low (vehicles with the  button)

The air conditioning system may not operate even when  is pressed.





**■ Ventilation and air conditioning odors**

- To let fresh air in, set the air conditioning system to the outside air mode.
- During use, various odors from inside and outside the vehicle may enter into and accumulate in the air conditioning system. This may then cause odor to be emitted from the vents.
- To reduce potential odors from occurring:  
It is recommended that the air conditioning system be set to outside air mode prior to turning the vehicle off.

**■ Air conditioning system operations when the engine is stopped due to the Stop & Start system (vehicles with a Stop & Start system)**

When the engine is stopped due to Stop & Start system operation, the air conditioning cooling, heating and dehumidification functions turn off and only ambient temperature air is blown. To prevent the air conditioning system from turning off, press the Stop & Start cancel switch to deactivate the system.

**■ When the windshield is fogged up and the engine is stopped due to the Stop & Start system (vehicles with a Stop & Start system)**

Press the Stop & Start cancel switch to restart the engine and turn  on to defog the windshield. Simply setting the air outlet selector dial to  will restart the engine and defog the windshield.

If the windshield continuously fogs up, press the Stop & Start cancel switch and refrain from using the Stop & Start system.

**■ When an odor comes from the air conditioning system while the engine is stopped due to the Stop & Start system (vehicles with a Stop & Start system)**

Press the Stop & Start cancel switch to restart the engine.

**■ Air conditioning filter**

→P. 478

**⚠ WARNING****■ To prevent the windshield from fogging up**

- Do not set the air outlet selector dial to  during cool air operation in extremely humid weather. The difference between the temperature of the outside air and that of the windshield can cause the outer surface of the windshield to fog up, blocking your vision.
- Do not place anything on the instrument panel which may cover the air outlets. Otherwise, air flow may be obstructed, preventing the windshield defoggers from defogging.

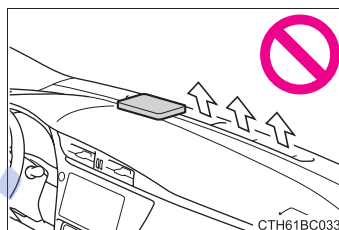
**■ To prevent burns (if equipped)**

- Do not touch the outside rear view mirror surfaces when the outside rear view mirror defoggers are on.
- Do not touch the glass at lower part of the windshield or to the side of the front pillars when the windshield wiper de-icer is on.

**⚠ NOTICE****■ To prevent battery discharge**

Do not leave the air conditioning system on longer than necessary when the engine is stopped.

FarmaSOS.com

## Automatic air conditioning system\*

Air outlets and fan speed are automatically adjusted according to the temperature setting.

The illustrations below are for left-hand drive vehicles.

The button positions and shapes will differ for right-hand drive vehicles.

Also, the display and button positions will differ depending on the type of the system.

### Air conditioning controls

- ▶ Vehicles without a blower customize function

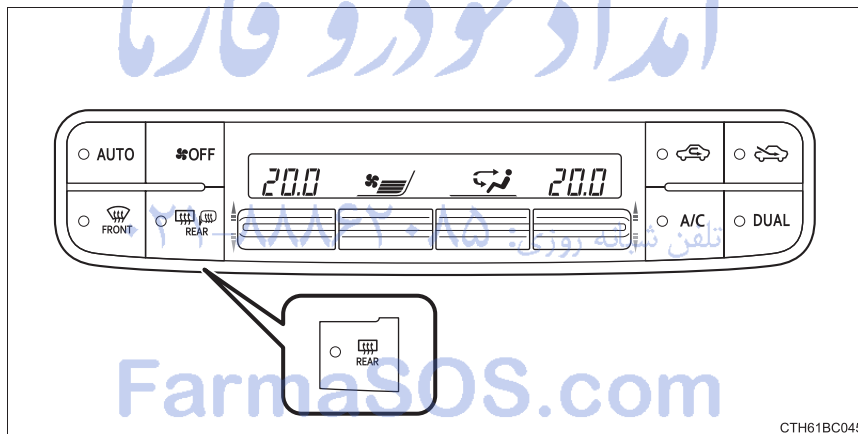

\*: If equipped

► Vehicles with a blower customize function

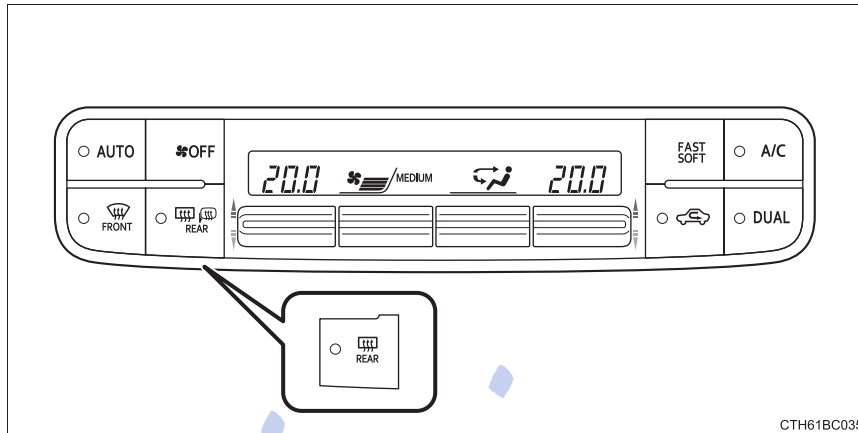

■ Adjusting the temperature setting

- ① Increases the temperature
- ② Decreases the temperature

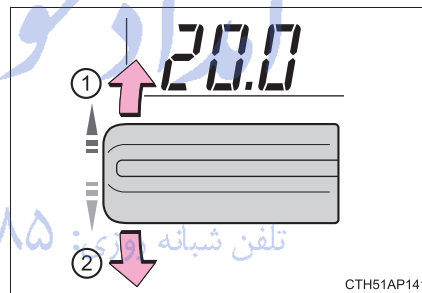

■ Fan speed setting

- ① Increases the fan speed
- ② Decreases the fan speed

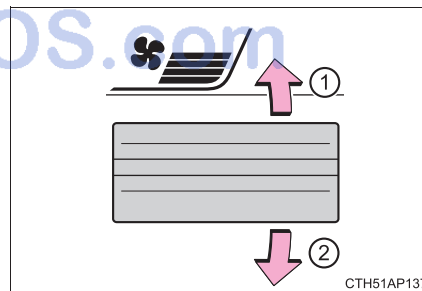

### ■ Change the airflow mode

To change the airflow mode, move the airflow change knob upward or downward.

The air outlets used are changed each time the knob is operated.

- ① Air flows to the upper body.
- ② Air flows to the upper body and feet.
- ③ Air flows to the feet.
- ④ Air flows to the feet and the windshield defogger operates.

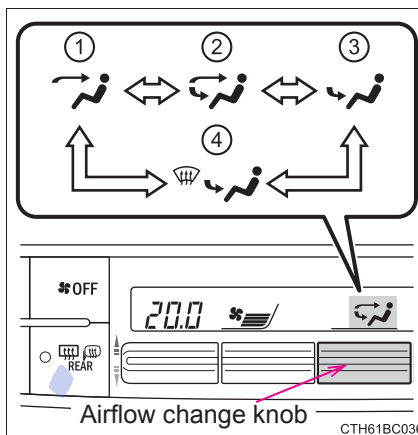

### Using automatic mode

- 1 Press  .

The dehumidification function begins to operate. Air outlets and fan speed are automatically adjusted according to the temperature setting.

- 2 Adjust the temperature setting.
- 3 To stop the operation, press  .

### ■ Automatic mode indicator

If the fan speed setting or air flow modes are operated, the automatic mode indicator goes off. However, automatic mode for functions other than that operated is maintained.

■ **Adjusting the temperature for driver and front passenger seats separately**

To turn on the dual control mode, perform any of the following procedures:

● Press  .

● Adjust the front passenger side temperature setting.

The indicator comes on when the dual control mode is on.

**Other functions**

■ **Switching between outside air and recirculated air modes**

▶ Vehicles without a blower customize function

Press  to change to recirculated air mode.

Press  to change to outside air mode.

When recirculated air mode is selected, the indicator on  illuminates.

When outside air mode is selected, the indicator on  illuminates.

▶ Vehicles with a blower customize function

Press  .

The mode switches between outside air mode (indicator off) and recirculated air mode (indicator on) each time  is pressed.

### ■ Defogging the windshield

Defoggers are used to defog the windshield and front side windows.

Press  .

The dehumidification function operates and fan speed increases.  
Set the outside/recirculated air mode button to the outside air mode if the recirculated air mode is used. (It may switch automatically.)  
To defog the windshield and the front side windows early, turn the air flow and temperature up.

To return to the previous mode, press  again when the windshield is defogged.

### ■ Defogging the rear window and outside rear view mirrors

- ▶ Vehicles without outside rear view mirror defoggers

A defogger is used to defog the rear window.

Press  .

Vehicles with timer: The defogger will automatically turn off after a period of time.

- ▶ Vehicles with outside rear view mirror defoggers

Defoggers are used to defog the rear window, and to remove rain-drops, dew and frost from the outside rear view mirrors.

Press  .

Vehicles with timer: The defogger will automatically turn off after a period of time.

■ **Blower customization (if equipped)**

Fan speed settings can be changed.

1 Press  .

2 Press  .

3 Each time  is pressed, the fan speed changes as follows.

“MEDIUM” → “SOFT” → “FAST”



■ **Windshield wiper de-icer (if equipped)**

This feature is used to prevent ice from building up on the windshield and wiper blades.

Press the switch to turn the system on/off.

The indicator comes on when the windshield wiper de-icer is on.

The windshield de-icer will automatically turn off after a period of time.

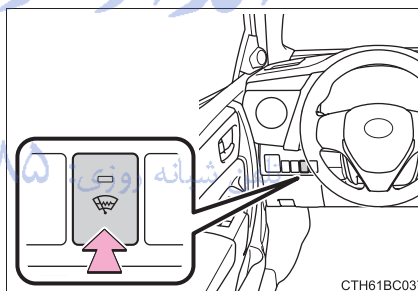

**Air outlets**

■ **Location of air outlets**

The air outlets and air volume change according to the selected airflow mode.

(→P. 401)

← : Some models

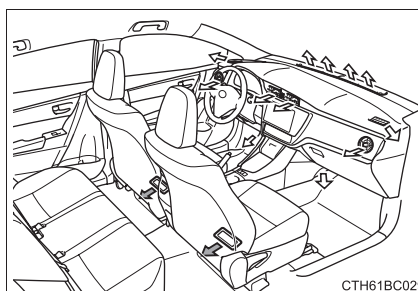



### ■ Adjusting the position of and opening and closing the air outlets

#### ▶ Front center outlets

- ① Direct air flow to the left or right, up or down.
- ② Turn the knob up to open the vent and down to close the vent.

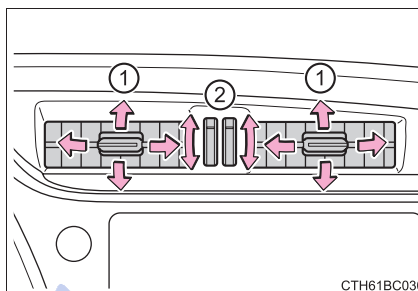

#### ▶ Front side outlets

Direct air flow to the left or right, up or down.

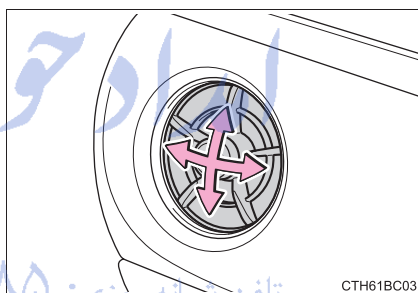

- ① Open the vent
- ② Close the vent

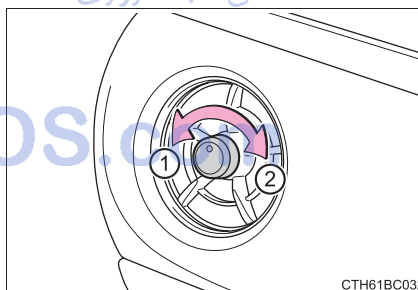



### ■ Using automatic mode



Fan speed is adjusted automatically according to the temperature setting and the ambient conditions.

Therefore, the fan may stop for a while until warm or cool air is ready to flow immediately after  is pressed.

### ■ Fogging up of the windows

- The windows will easily fog up when the humidity in the vehicle is high.



Turning  or  on will dehumidify the air from the outlets and defog the windshield effectively.

- If you turn  or  off, the windows may fog up more easily.
- The windows may fog up if the recirculated air mode is used.

### ■ Outside/recirculated air mode

- When driving on dusty roads such as tunnels or in heavy traffic, set the outside/recirculated air mode button to the recirculated air mode. This is effective in preventing outside air from entering the vehicle interior. During cooling operation, setting the recirculated air mode will also cool the vehicle interior effectively.
- Outside/recirculated air mode may automatically switch depending on the temperature setting or the inside temperature.

### ■ When the outside temperature is low

The dehumidification function may not operate even when  or  is pressed.

### ■ Ventilation and air conditioning odors



- To let fresh air in, set the air conditioning system to the outside air mode.
- During use, various odors from inside and outside the vehicle may enter into and accumulate in the air conditioning system. This may then cause odor to be emitted from the vents.
- To reduce potential odors from occurring:
  - It is recommended that the air conditioning system be set to outside air mode prior to turning the vehicle off.
  - The start timing of the blower may be delayed for a short period of time immediately after the air conditioning system is started in automatic mode.

**■ Air conditioning system operations when the engine is stopped due to the Stop & Start system (vehicles with a Stop & Start system)**

When the engine is stopped due to Stop & Start system operation, the air conditioning cooling, heating and dehumidification functions turn off and only ambient temperature air is blown, and there is a possibility that the blowing of ambient temperature air will stop. To prevent the air conditioning system from turning off, press the Stop & Start cancel switch to deactivate the system.

**■ When the windshield is fogged up and the engine is stopped due to the Stop & Start system (vehicles with a Stop & Start system)**

Press the Stop & Start cancel switch to restart the engine and turn  or

 on to defog the windshield. Simply pressing  will restart the engine and defog the windshield.

If the windshield continuously fogs up, press the Stop & Start cancel switch and refrain from using the Stop & Start system.

**■ When an odor comes from the air conditioning system while the engine is stopped due to the Stop & Start system (vehicles with a Stop & Start system)**

Press the Stop & Start cancel switch to restart the engine.

**■ Air conditioning filter**

→P. 478

**■ Customization**

Settings (e.g. air conditioning setting) can be changed. (Customizable features →P. 611)

**⚠ WARNING**

■ **To prevent the windshield from fogging up**

- Do not use  during cool air operation in extremely humid weather. The difference between the temperature of the outside air and that of the windshield can cause the outer surface of the windshield to fog up, blocking your vision.
- Do not place anything on the instrument panel which may cover the air outlets. Otherwise, air flow may be obstructed, preventing the windshield defoggers from defogging.

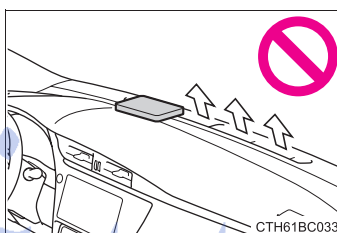

■ **To prevent burns (if equipped)**

- Do not touch the outside rear view mirror surfaces when the outside rear view mirror defoggers are on.
- Do not touch the glass at lower part of the windshield or to the side of the front pillars when the windshield wiper de-icer is on.

**⚠ NOTICE**

■ **To prevent battery discharge**

Do not leave the air conditioning system on longer than necessary when the engine is stopped.

تلفن شبانه روزی: ۰۸۵-۸۸۸۶۲-۲۱  
FarmaSOS.com

## Power heater\*

This feature is used to keep the cab warm in cold conditions.

### On/off

The power heater turns on about 30 seconds after you press the switch and it takes about another 55 seconds to warm up.

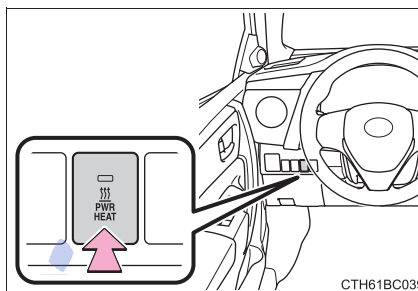

CTH61BC039

### ■ Power heater can be operated when

The engine is running.

### ■ Normal characteristics of power heater operation

The following cases do not indicate a malfunction:

- When the power heater is turned on or off, some white smoke and a slight odor may be emitted from the power heater exhaust that is located under the floor.
- When the power heater is being used under extremely cold conditions, vapor may be visible from its exhaust.
- When the power heater is turned off, you may hear a sound in the engine compartment for about 2 minutes until the power heater turns off completely.

### ■ After the heater is turned off

We recommend not restarting the heater for 10 minutes after you turn it off. Otherwise, a noise may be heard as the heater ignites.

### ■ When refueling your vehicle

The engine must be turned off. Turning the engine off turns the power heater off.

6

Interior features

\*: If equipped

**⚠ WARNING**

■ **To prevent burns or damage to your vehicle**

- Do not touch the heater or its exhaust pipe as they are hot. You may burn yourself.
- Keep flammable items such as fuel away from the heater and its exhaust pipe. This may cause a fire.

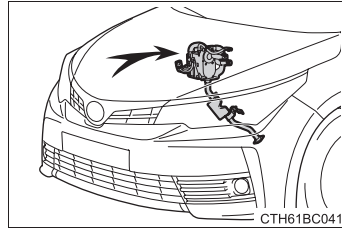

**⚠ NOTICE**

■ **To prevent damage to your vehicle**

- Do not turn the heater on and off repeatedly in 5 minute intervals as this can shorten the life of the heater components. If the engine must be turned on and off repeatedly within short intervals (such as when the vehicle is being used for delivery purposes), turn the heater off.
- Do not modify or open the heater without consulting any authorized Toyota dealer or repairer, or another duly qualified and equipped professional. This may cause a heater malfunction or a fire.
- Be careful not to splash water or spill liquid directly on the heater or on the heater fuel pump. This may cause the heater to malfunction.
- Keep the intake and exhaust pipes of the heater free from water, snow, ice, mud, etc. If the pipes become clogged, this can cause the heater to malfunction.
- If you notice anything unusual, such as a fluid leak, smoke or poor operation, turn off the heater and have your vehicle checked by any authorized Toyota dealer or repairer, or another duly qualified and equipped professional.

## Seat heaters\*

### ⚠ WARNING

- Care should be taken to prevent injury if anyone in the following categories comes in contact with the seats when the heater is on:
  - Babies, small children, the elderly, the sick and the physically challenged
  - Persons with sensitive skin
  - Persons who are fatigued
  - Persons who have taken alcohol or drugs that induce sleep (sleeping drugs, cold remedies, etc.)
- Observe the following precautions to prevent the minor burns or overheating
  - Do not cover the seat with a blanket or cushion when using the seat heater.
  - Do not use seat heater more than necessary.

### ⚠ NOTICE

- Do not put heavy objects that have an uneven surface on the seat and do not stick sharp objects (needles, nails, etc.) into the seat.
- To prevent battery discharge, do not use the functions when the engine is not running.

After pulling the lid to open, press the switch.

- ① High temperature
- ② Low temperature

The indicator light comes on when the switch is on.

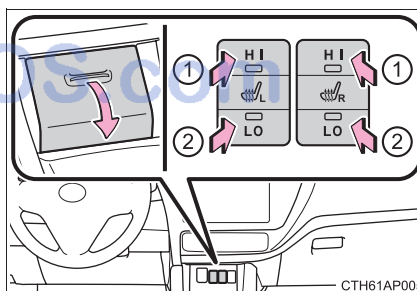

CTH61AP005

6

Interior features

\*: If equipped

■ **The seat heaters can be used when**

- ▶ Vehicles without a smart entry & start system

The engine switch is in the "ON" position.

- ▶ Vehicles with a smart entry & start system

The engine switch is in IGNITION ON mode.

■ **When not in use**

Put the switch in the neutral position. The indicator will turn off.

امداد خودرو فارما

تلفن شبانه روزی: ۰۲۱-۸۸۸۶۲۰۸۵

FarmaSOS.com



## Interior lights list

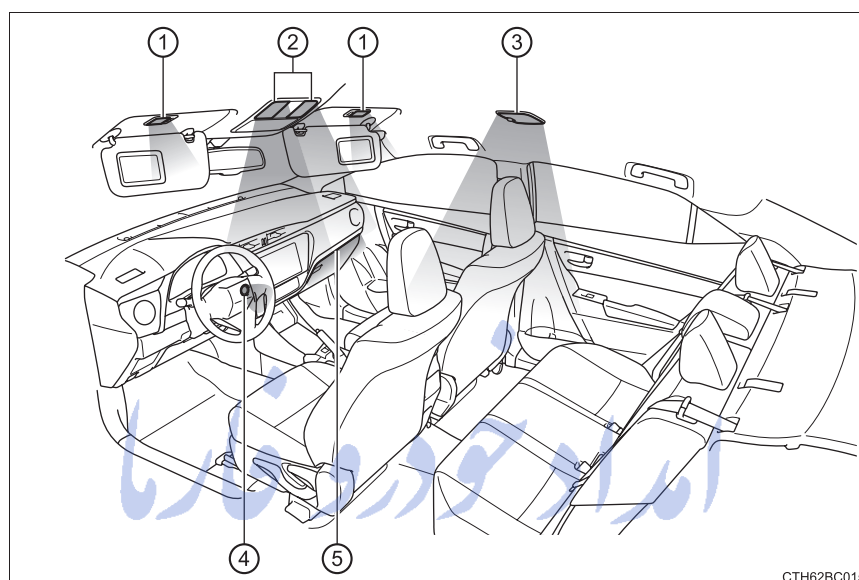

- ① Vanity lights (if equipped) (→P. 414)
- ② Front interior light/personal lights (→P. 414)
- ③ Rear interior light (→P. 415)
- ④ Engine switch light (vehicles with a smart entry & start system)
- ⑤ Ambient light (if equipped)

### Front interior light/personal lights

#### ■ Front interior light

- ① Door position
- ② Off

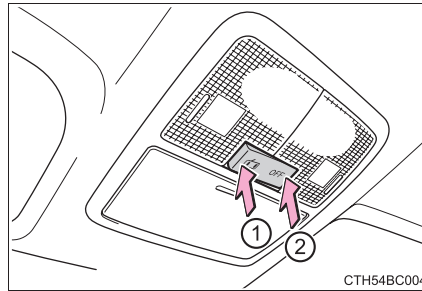

#### ■ Personal lights

##### On/off

When a light is on due to its door link switch, the light will not turn off even if the lens is pressed.

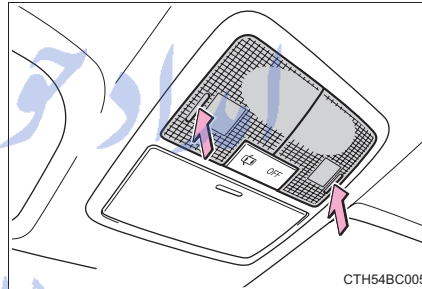

### Vanity lights (if equipped)

- ① On
- ② Off

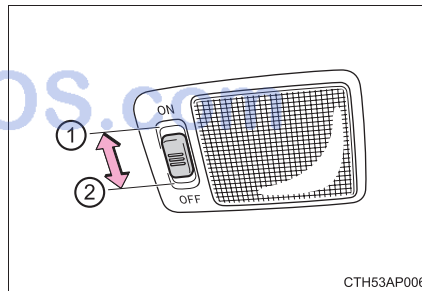

### Rear interior light

- ① On
- ② Door position
- ③ Off

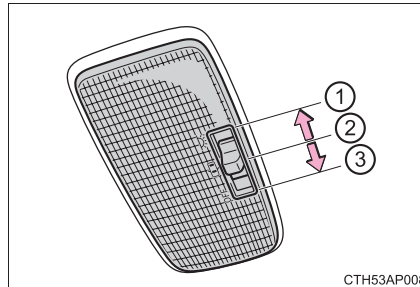

#### ■ Illuminated entry system

- ▶ Vehicles without a smart entry & start system

When the interior light switch is in the door position, the interior light automatically turns on/off according to the engine switch position, whether the doors are locked/unlocked and whether the doors are open/closed.

- ▶ Vehicles with a smart entry & start system

When the interior light switch is in the door position, the interior light and engine switch light automatically turn on/off according to engine switch mode, the presence of the electronic key, whether the doors are locked/unlocked and whether the doors are open/closed.

#### ■ To prevent battery discharge

The following lights will go off automatically after 20 minutes:

- Front interior light/personal lights
- Rear interior light
- Trunk light
- Vanity lights (if equipped)

#### ■ Customization that can be configured at any authorized Toyota dealer or repairer, or another duly qualified and equipped professional

Setting (e.g. the time elapsed before lights turn off) can be changed.  
(Customizable features: →P. 611)

## List of storage features

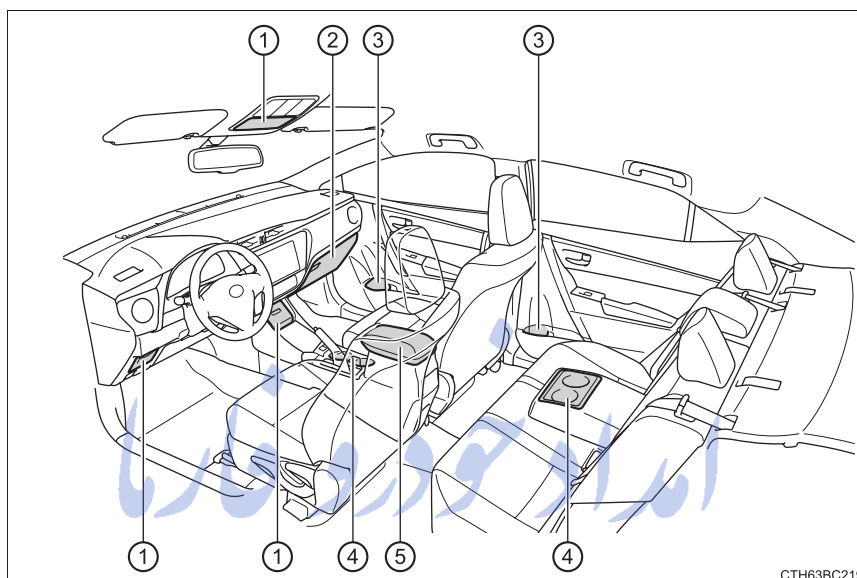

- ① Auxiliary boxes (→P. 420)
- ② Glove box (→P. 417)
- ③ Bottle holders (→P. 418)
- ④ Cup holders (→P. 419)
- ⑤ Console box (→P. 417)

### ⚠ WARNING

- Do not leave glasses, lighters or spray cans in the storage spaces, as this may cause the following when cabin temperature becomes high:
  - Glasses may be deformed by heat or cracked if they come into contact with other stored items.
  - Lighters or spray cans may explode. If they come into contact with other stored items, the lighter may catch fire or the spray can may release gas, causing a fire hazard.
- When driving or when the storage compartments are not in use, keep the lids closed.  
In the event of sudden braking or sudden swerving, an accident may occur due to an occupant being struck by an open lid or the items stored inside.

**Glove box**

Pull up the lever to open the glove box.

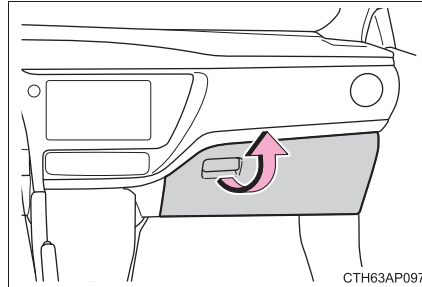

CTH63AP097

The glove box light turns on when the tail lights are on.

**Console box**

## ▶ Console box

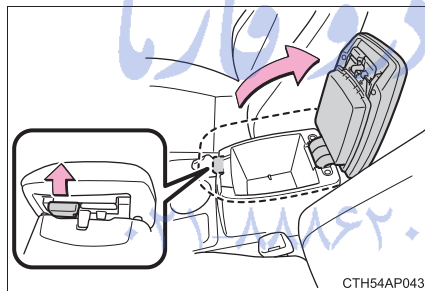

CTH54AP043

## ▶ Upper level box

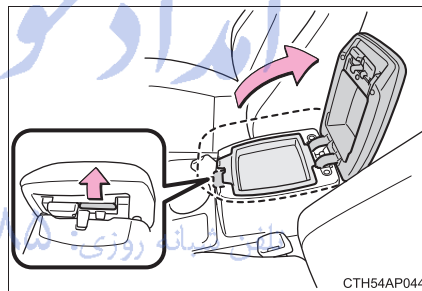

CTH54AP044

Lift the lid while pulling up the knob on the right side.

Lift the lid while pulling up the knob on the left side.

■ **When using the console box lid as an armrest (sliding type only)**

If necessary, the console box lid can be slid forward. Pull the lid forward by grasping the front of the lid.

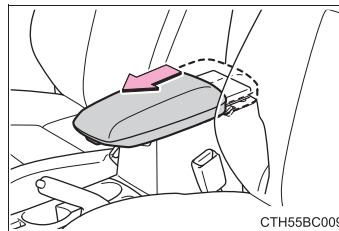

CTH55BC009

### Bottle holders

► Front

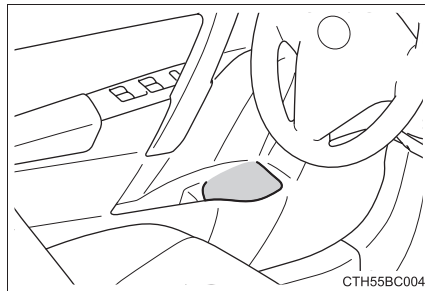

► Rear

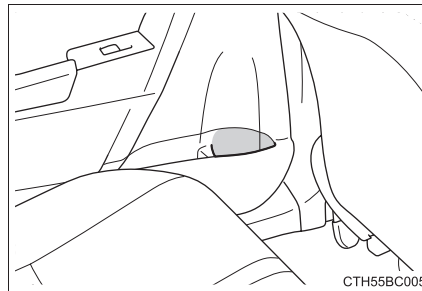

- When storing a bottle, close the cap.
- The bottle may not be stored depending on its size or shape.

#### ⚠ WARNING

Do not place anything other than a bottle in the bottle holders. Other items may be thrown out of the holders in the event of an accident or sudden braking and cause injury.

#### ⚠ NOTICE

Put the cap on before stowing a bottle. Do not place open bottles in the bottle holders, or glass or paper cups containing liquid. The contents may spill and glass cups may break.

FarmaSOS.com

### Cup holders

#### ► Front

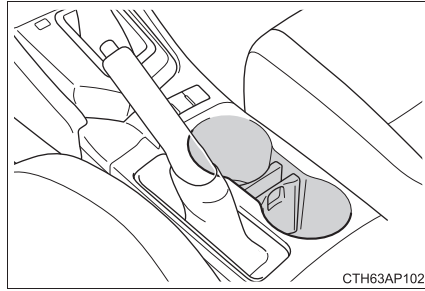

#### ► Rear (if equipped)

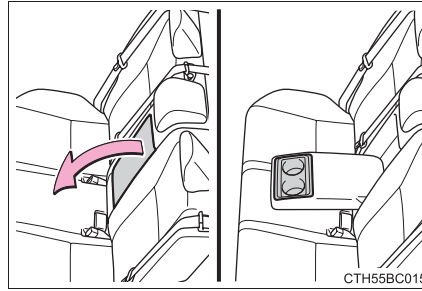

Pull the armrest down.

#### ■ Adjusting the size of the cup holder (front)

- 1 Remove the cup holder insert.

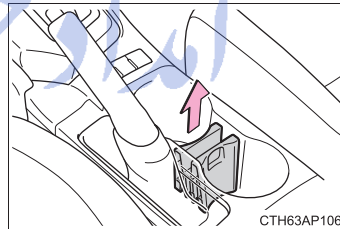

- 2 Change the cup holder insert position.

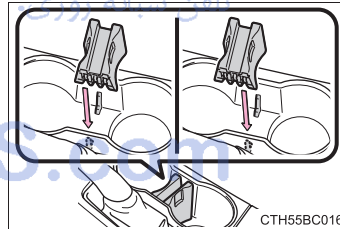

#### ■ Removing the cup holder insert (front)

The cup holder insert may be removed for cleaning.

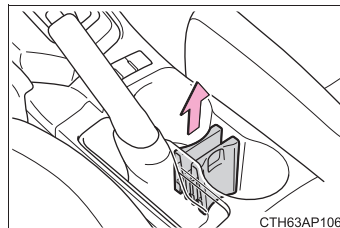

**⚠ WARNING**

Do not place anything other than cups or aluminum cans in the cup holders. Other items may be thrown out of the holders in the event of an accident or sudden braking, causing injury. If possible, cover hot drinks to prevent burns.

**Auxiliary boxes**

▶ Type A

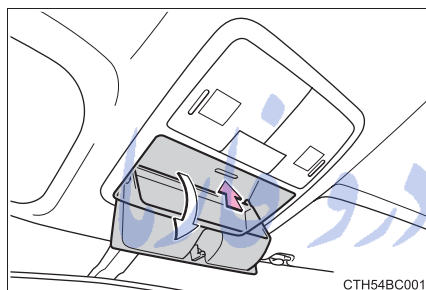

Push the lid to open.

▶ Type B

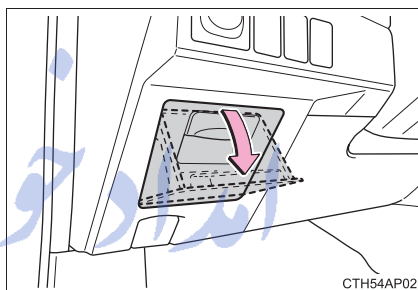

Pull the tab to open.

▶ Type C

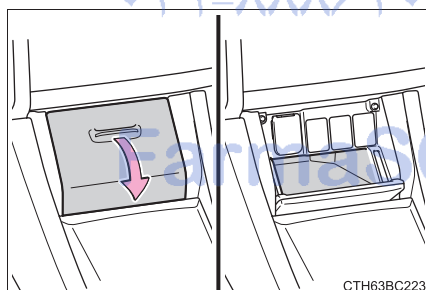

Pull the lid to open.



**⚠ WARNING**

- Keep the auxiliary boxes closed. In the event of sudden braking, an accident may occur due to an occupant being struck by an open auxiliary box or the items stored inside.
- Type A only: Do not store items heavier than 0.2 kg (0.4 lb.). Doing so may cause the auxiliary box to open and the items inside may fall out, resulting in an accident.

امداد خودرو فارما

تلفن شبانه روزی: ۰۲۱-۸۸۸۶۲۰۸۵

FarmaSOS.com

## Trunk features

### Grocery bag hook

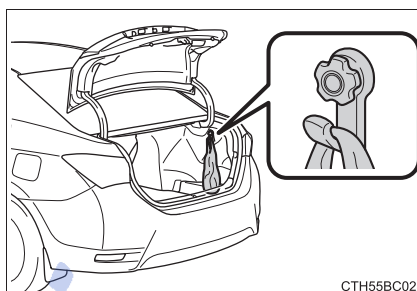

 NOTICE

Do not hang any object heavier than 3 kg (6.6 lb.).

تلفن شبانه روزی: ۰۲۱-۸۸۸۶۲۰۸۵

FarmaSOS.com

## Other interior features

### Sun visors

- ① To set the visor in the forward position, flip it down.
- ② To set the visor in the side position, flip down, unhook, and swing it to the side.

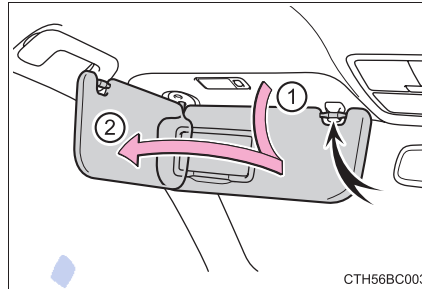

### Vanity mirrors

Open the cover.

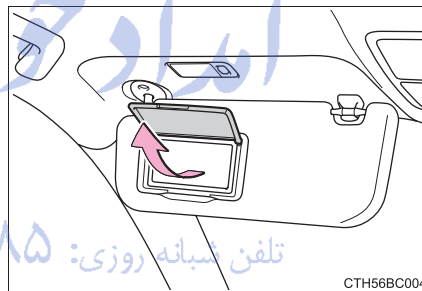

### Clock

The clock can be adjusted.

- ① Adjusts the hours
- ② Adjusts the minutes

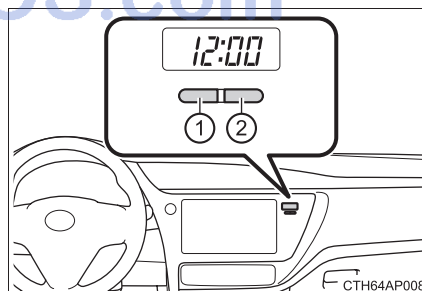

■ **The clock is displayed when**

- ▶ Vehicles without a smart entry & start system  
The engine switch is in the “ACC” or “ON” position.
- ▶ Vehicles with a smart entry & start system  
The engine switch is in ACCESSORY or IGNITION ON mode.

■ **When the battery is disconnected**

The clock data will be reset.

**Power outlets**

Please use as a power supply for electronic goods that use less than 12 VDC/10 A (power consumption of 120 W).

▶ **Front**

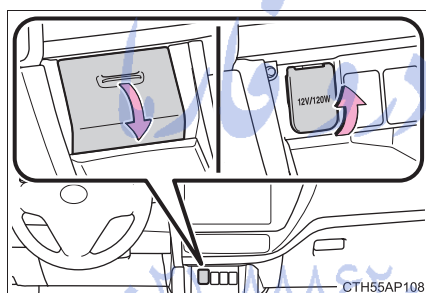

▶ **Rear (if equipped)**

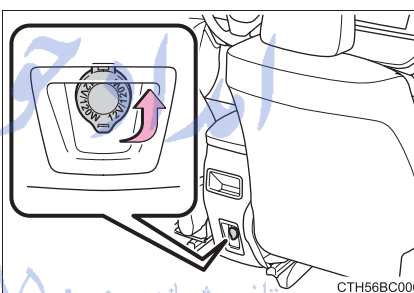

After pulling the lid to open, open the cover.

Open the cover.

■ **The power outlets can be used when**

- ▶ Vehicles without a smart entry & start system  
The engine switch is in the “ACC” or “ON” position.
- ▶ Vehicles with a smart entry & start system  
The engine switch is in ACCESSORY or IGNITION ON mode.

 **NOTICE**

- To avoid damaging the power outlets, close the power outlet covers when the power outlets are not in use.  
Foreign objects or liquids that enter the power outlets may cause a short circuit.
- To prevent battery discharge, do not use the power outlets longer than necessary when the engine is not running.

**Armrest (if equipped)**

Fold down the armrest for use.

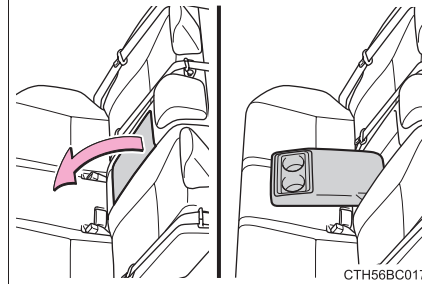
**NOTICE**

To prevent damage to the armrest, do not apply too much load on the armrest.

**Coat hook**

The coat hook is provided with the rear assist grip (driver's side).

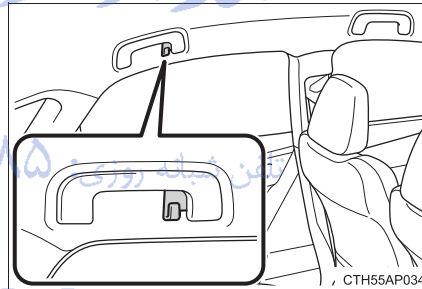
**WARNING**

Do not hang coat hangers or other hard or sharp objects on the hook. If the SRS curtain shield airbags deploy, these items may become projectiles, causing death or serious injury.

### Assist grips

An assist grip installed on the ceiling can be used to support your body while sitting on the seat.

- ① Front
- ② Rear

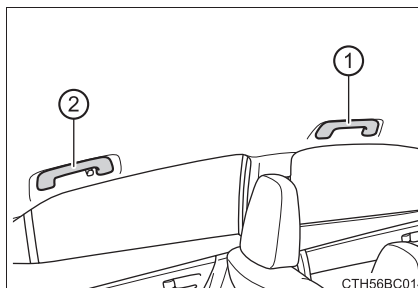

#### ⚠ WARNING

Do not use the assist grip when getting in or out of the vehicle or rising from your seat.

#### ⚠ NOTICE

To prevent damage to the assist grip, do not put a heavy load on the assist grip.

تلفن شبانه روزی: ۰۲۱-۸۸۸۶۲۰۸۵

FarmaSOS.com

## Maintenance and care

## 7

**7-1. Maintenance and care**

- Cleaning and protecting the vehicle exterior .....428
- Cleaning and protecting the vehicle interior .....432

**7-2. Maintenance**

- Maintenance requirements.....435

**7-3. Do-it-yourself maintenance**

- Do-it-yourself service precautions .....438
- Hood .....441
- Positioning a floor jack.....443
- Engine compartment.....444
- Tires.....460
- Tire inflation pressure .....473
- Wheels .....475
- Air conditioning filter .....478
- Wireless remote control/ electronic key battery.....480
- Checking and replacing fuses .....483
- Light bulbs .....488

## Cleaning and protecting the vehicle exterior

### Perform the following to protect the vehicle and maintain it in prime condition:

- Working from top to bottom, liberally apply water to the vehicle body, wheel wells and underside of the vehicle to remove any dirt and dust.
- Wash the vehicle body using a sponge or soft cloth, such as a chamois.
- For hard-to-remove marks, use car wash soap and rinse thoroughly with water.
- Wipe away any water.
- Wax the vehicle when the waterproof coating deteriorates.  
If water does not bead on a clean surface, apply wax when the vehicle body is cool.

#### ■ Automatic car washes

- Fold the mirrors before washing the vehicle. Start washing from the front of the vehicle. Make sure to extend the mirrors before driving.
- Brushes used in automatic car washes may scratch the vehicle surface and harm your vehicle's paint.

#### ■ High pressure car washes

- Do not allow the nozzles of the car wash to come within close proximity of the windows.
- Before using the car wash, check that the fuel filler door on your vehicle is closed properly.



**■ When using a car wash (vehicles with a smart entry & start system)**

If the door handle becomes wet while the electronic key is within the effective range, the door may lock and unlock repeatedly. In that case, follow the following correction procedures to wash the vehicle:

- Place the key in a position 2 m (6 ft.) or more separate from the vehicle while the vehicle is being washed. (Take care to ensure that the key is not stolen.)
- Set the electronic key to battery-saving mode to disable the smart entry & start system. (→P. 141)

**■ Aluminum wheels (if equipped)**

- Remove any dirt immediately by using a neutral detergent. Do not use hard brushes or abrasive cleaners. Do not use strong or harsh chemical cleaners.  
Use the same mild detergent and wax as used on the paint.
- Do not use detergent on the wheels when they are hot, for example after driving for long distance in the hot weather.
- Wash detergent from the wheels immediately after use.

**■ Bumpers**

Do not scrub with abrasive cleaners.

تلفن شبانه روزی: ۰۲۱-۸۸۸۶۲۰۸۵

FarmaSOS.com

**⚠ WARNING****■ When washing the vehicle**

Do not apply water to the inside of the engine compartment. Doing so may cause the electrical components etc. to catch fire.

**■ When cleaning the windshield (vehicles with rain-sensing windshield wipers)**

Set the wiper switch to off.

If the wiper switch is in "AUTO", the wipers may operate unexpectedly in the following situations, and may result in hands being caught or other serious injuries and cause damage to the wiper blades.

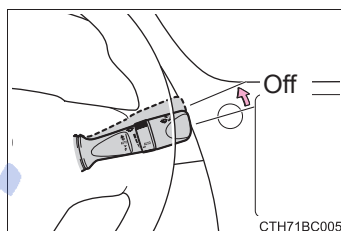

- When the upper part of the windshield where the raindrop sensor is located is touched by hand
- When a wet rag or similar is held close to the raindrop sensor
- If something bumps against the windshield
- If you directly touch the raindrop sensor body or if something bumps into the raindrop sensor

**■ Precautions regarding the exhaust pipe**

Exhaust gasses cause the exhaust pipe to become quite hot.

When washing the vehicle, be careful not to touch the pipe until it has cooled sufficiently, as touching a hot exhaust pipe can cause burns.

FarmaSOS.com

 NOTICE**■ To prevent paint deterioration and corrosion on the body and components (aluminum wheels etc.)**

● Wash the vehicle immediately in the following cases:

- After driving near the sea coast
- After driving on salted roads
- If coal tar or tree sap is present on the paint surface
- If dead insects, insect droppings or bird droppings are present on the paint surface
- After driving in an area contaminated with soot, oily smoke, mine dust, iron powder or chemical substances
- If the vehicle becomes heavily soiled with dust or mud
- If liquids such as benzene and gasoline are spilled on the paint surface

● If the paint is chipped or scratched, have it repaired immediately.

● To prevent the wheels from corroding, remove any dirt and store in a place with low humidity when storing the wheels.

**■ Cleaning the exterior lights**

● Wash carefully. Do not use organic substances or scrub with a hard brush. This may damage the surfaces of the lights.

● Do not apply wax to the surfaces of the lights. Wax may cause damage to the lenses.

**■ To prevent damage to the windshield wiper arms**

When lifting the wiper arms away from the windshield, pull the driver side wiper arm upward first, and repeat for the passenger side. When returning the wipers to their original position, do so from the passenger side first.

**■ When using an automatic car wash (vehicles with rain-sensing windshield wipers)**

Set the wiper switch to the off position.

If the wiper switch is in "AUTO", the wipers may operate and the wiper blades may be damaged.

**■ When using a high pressure car wash**

Do not bring the nozzle tip close to boots (rubber or resin manufactured cover), connectors or the following parts. The parts may be damaged if they come into contact with high-pressure water.

- Traction related parts
- Steering parts
- Suspension parts
- Brake parts

## Cleaning and protecting the vehicle interior

The following procedures will help protect your vehicle's interior and keep it in top condition:

### Protecting the vehicle interior

- Remove dirt and dust using a vacuum cleaner. Wipe dirty surfaces with a cloth dampened with lukewarm water.
- If dirt cannot be removed, wipe it off with a soft cloth dampened with neutral detergent diluted to approximately 1%.
- Wring out any excess water from the cloth and thoroughly wipe off remaining traces of detergent and water.

### Cleaning the leather areas

- Remove dirt and dust using a vacuum cleaner.
- Wipe off any excess dirt and dust with a soft cloth dampened with diluted detergent.  
Use a diluted water solution of approximately 5% neutral wool detergent.
- Wring out any excess water from the cloth and thoroughly wipe off all remaining traces of detergent.
- Wipe the surface with a dry, soft cloth to remove any remaining moisture. Allow the leather to dry in a shaded and ventilated area.

### Cleaning the synthetic leather areas

- Remove dirt and dust using a vacuum cleaner.
- Wipe it off with a soft cloth dampened with neutral detergent diluted to approximately 1%.
- Wring out any excess water from the cloth and thoroughly wipe off remaining traces of detergent and water.

**■ Caring for leather areas**

Toyota recommends cleaning the interior of the vehicle at least twice a year to maintain the quality of the vehicle's interior.

**■ Shampooing the carpets**

There are several commercial foaming-type cleaners available. Use a sponge or brush to apply the foam. Rub in overlapping circles. Do not use water. Wipe dirty surfaces and let them dry. Excellent results are obtained by keeping the carpet as dry as possible.

**■ Seat belts**

Clean with mild soap and lukewarm water using a cloth or sponge. Also check the belts periodically for excessive wear, fraying or cuts.

**⚠ WARNING****■ Water in the vehicle**

- Do not splash or spill liquid in the vehicle. Doing so may cause electrical components etc. to malfunction or catch fire.
- Do not get any of the SRS components or wiring in the vehicle interior wet. (→P. 44)  
An electrical malfunction may cause the airbags to deploy or not function properly, resulting in death or serious injury.

**■ Cleaning the interior (especially instrument panel)**

Do not use polish wax or polish cleaner. The instrument panel may reflect off the windshield, obstructing the driver's view and leading to an accident, resulting in death or serious injury.

 NOTICE**■ Cleaning detergents**

- Do not use the following types of detergent, as they may discolor the vehicle interior or cause streaks or damage to painted surfaces:
  - Non-seat portions: Organic substances such as benzene or gasoline, alkaline or acidic solutions, dye, and bleach
  - Seats: Alkaline or acidic solutions, such as thinner, benzene, and alcohol
- Do not use polish wax or polish cleaner. The instrument panel's or other interior part's painted surface may be damaged.

**■ Preventing damage to leather surfaces**

Observe the following precautions to avoid damage to and deterioration of leather surfaces:

- Remove any dust or dirt from leather surfaces immediately.
- Do not expose the vehicle to direct sunlight for extended periods of time. Park the vehicle in the shade, especially during summer.
- Do not place items made of vinyl, plastic, or containing wax on the upholstery, as they may stick to the leather surface if the vehicle interior heats up significantly.

**■ Water on the floor**

Do not wash the vehicle floor with water.

Vehicle systems such as the audio system may be damaged if water comes into contact with electrical components such as the audio system above or under the floor of the vehicle. Water may also cause the body to rust.

**■ Cleaning the inside of the rear window**

- Do not use glass cleaner to clean the rear window, as this may cause damage to the rear window defogger heater wires or antenna. Use a cloth dampened with lukewarm water to gently wipe the window clean. Wipe the window in strokes running parallel to the heater wires or antenna.
- Be careful not to scratch or damage the heater wires or antenna.

## Maintenance requirements

**To ensure safe and economical driving, day-to-day care and regular maintenance are essential. Toyota recommends the following maintenance:**

### Scheduled maintenance

Scheduled maintenance should be performed at specified intervals according to the maintenance schedule.

For full details of your maintenance schedule, refer to the “Toyota Service Booklet” or “Toyota Warranty Booklet”.

### Do-it-yourself maintenance

What about do-it-yourself maintenance?

Many maintenance items are easy to do yourself if you have a little mechanical ability and a few basic automotive tools.

Note, however, that some maintenance tasks require special tools and skills. These are best performed by qualified technicians. Even if you're an experienced do-it-yourself mechanic, we recommend that repairs and maintenance be conducted by any authorized Toyota dealer or repairer, or another duly qualified and equipped professional. Any authorized Toyota dealer or repairer will keep a record of maintenance, which could be useful should you ever require Warranty Service. Should you choose to select a qualified and equipped professional other than an authorized Toyota repairer to service or maintain your vehicle, we recommend that you request that a record of maintenance be kept.

**■ Where to go for maintenance service?**

In order to maintain your vehicle in the best possible condition, Toyota recommends that maintenance service operations as well as other inspections and repairs be carried out by authorized Toyota dealers or repairers or other duly qualified and equipped professionals. For repairs and services covered by your warranty, please visit an authorized Toyota dealer or repairer, who will use genuine Toyota parts in repairing any difficulties you may encounter. There can also be advantages in utilizing authorized Toyota dealers or repairers for non-warranty repairs and services, as members of the Toyota network will be able to expertly assist you with any difficulties you may encounter.

Your Toyota dealer or repairer, or another duly qualified and equipped professional will perform all of the scheduled maintenance on your vehicle reliably and economically due to their experience with Toyota vehicles.

**■ Does your vehicle need repair?**

Be on the alert for changes in performance and sounds, and visual tip-offs that indicate service is needed. Some important clues are:

- Engine missing, stumbling, or pinging
- Appreciable loss of power
- Strange engine noises
- A fluid leak under the vehicle (However, water dripping from the air conditioning after use is normal.)
- Change in exhaust sound (This may indicate a dangerous carbon monoxide leak. Drive with the windows open and have the exhaust system checked immediately.)
- Flat-looking tires, excessive tire squeal when cornering, uneven tire wear
- Vehicle pulls to one side when driving straight on a level road
- Strange noises related to suspension movement
- Loss of brake effectiveness, spongy feeling brake pedal or clutch pedal (vehicles with a manual transmission), pedal almost touches the floor, vehicle pulls to one side when braking
- Engine coolant temperature continually higher than normal

If you notice any of these clues, take your vehicle to any authorized Toyota dealer or repairer, or another duly qualified and equipped professional, as soon as possible. Your vehicle may need adjustment or repair.



**⚠ WARNING****■ If your vehicle is not properly maintained**

Improper maintenance could result in serious damage to the vehicle and possible serious injury or death.

**■ Handling of the battery**

Battery posts, terminals and related accessories contain lead and lead compounds which are known to cause brain damage. Wash your hands after handling. (→P. 454)

امداد خودرو فارما

تلفن شبانه روزی: ۰۲۱-۸۸۸۶۲۰۸۵

FarmaSOS.com

## Do-it-yourself service precautions

If you perform maintenance by yourself, be sure to follow the correct procedure as given in these sections.

Items	Parts and tools
Battery condition (→P. 454)	<ul style="list-style-type: none"> <li>• Warm water</li> <li>• Baking soda</li> <li>• Grease</li> <li>• Conventional wrench (for terminal clamp bolts)</li> </ul>
Engine coolant level (→P. 452)	<ul style="list-style-type: none"> <li>• “Toyota Super Long Life Coolant” or a similar high quality ethylene glycol-based non-silicate, non-amine, non-nitrite and non-borate coolant with long-life hybrid organic acid technology</li> <li>• “Toyota Super Long Life Coolant” is pre-mixed with 50% coolant and 50% deionized water.</li> <li>• Funnel (used only for adding coolant)</li> </ul>
Engine oil level (→P. 447)	<ul style="list-style-type: none"> <li>• “Toyota Genuine Motor Oil” or equivalent</li> <li>• Rag or paper towel</li> <li>• Funnel (used only for adding engine oil)</li> </ul>
Fuses (→P. 483)	<ul style="list-style-type: none"> <li>• Fuse with same amperage rating as original</li> </ul>
Light bulbs (→P. 488)	<ul style="list-style-type: none"> <li>• Bulb with same number and wattage rating as original</li> <li>• Phillips-head screwdriver</li> <li>• Flathead screwdriver</li> <li>• Wrench</li> </ul>
Radiator, condenser and inter-cooler (→P. 453)	
Tire inflation pressure (→P. 473)	<ul style="list-style-type: none"> <li>• Tire pressure gauge</li> <li>• Compressed air source</li> </ul>
Washer fluid (→P. 457)	<ul style="list-style-type: none"> <li>• Water or washer fluid containing antifreeze (for winter use)</li> <li>• Funnel (used only for adding water or washer fluid)</li> </ul>

 **WARNING**

The engine compartment contains many mechanisms and fluids that may move suddenly, become hot, or become electrically energized. To avoid death or serious injury, observe the following precautions.

**■ When working on the engine compartment**

- Keep hands, clothing and tools away from the moving fan and engine drive belt.
- Be careful not to touch the engine, radiator, exhaust manifold, etc. right after driving as they may be hot. Oil and other fluids may also be hot.
- Do not leave anything that may burn easily, such as paper and rags, in the engine compartment.
- Do not smoke, cause sparks or expose an open flame to fuel or the battery. Fuel and battery fumes are flammable.
- Be extremely cautious when working on the battery. It contains poisonous and corrosive sulfuric acid.
- Take care because brake fluid can harm your hands or eyes and damage painted surfaces. If fluid gets on your hands or in your eyes, flush the affected area with clean water immediately.  
If you still experience discomfort, consult a doctor.

تلفن شبانه روزی: ۰۲۱-۸۸۶۲۰۸۵

FarmaSOS.com

 **WARNING****■ When working near the electric cooling fan or radiator grille**

Vehicles without a smart entry & start system: Be sure the engine switch is off.

With the engine switch in the "ON" position, the electric cooling fan may automatically start to run if the air conditioning is on and/or the coolant temperature is high. (→P. 453)

Vehicles with a smart entry & start system: Be sure the engine switch is off. With the engine switch in IGNITION ON mode, the electric cooling fan may automatically start to run if the air conditioning is on and/or the coolant temperature is high. (→P. 453)

**■ Safety glasses**

Wear safety glasses to prevent flying or falling material, fluid spray, etc. from getting in your eyes.

 **NOTICE****■ If you remove the air cleaner filter**

Driving with the air cleaner filter removed may cause excessive engine wear due to dirt in the air.

**■ If the fluid level is low or high**

It is normal for the brake fluid level to go down slightly as the brake pads wear or when the fluid level in the accumulator is high.

If the reservoir needs frequent refilling, it may indicate a serious problem.

FarmaSOS.com

## Hood

### Release the lock from the inside of the vehicle to open the hood.

- 1 Pull the hood lock release lever.  
The hood will pop up slightly.

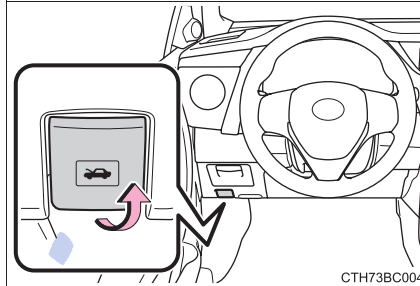

- 2 Pull up the auxiliary catch lever and lift the hood.

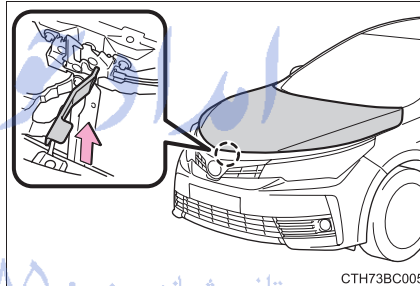

- 3 Hold the hood open by inserting the support rod into the slot.

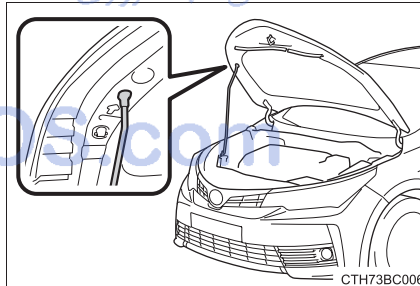

 WARNING

■ **Pre-driving check**

Check that the hood is fully closed and locked.  
If the hood is not locked properly, it may open while the vehicle is in motion and cause an accident, which may result in death or serious injury.

■ **After installing the support rod into the slot**

Make sure the rod supports the hood securely preventing it from falling down onto your head or body.

 NOTICE

■ **When closing the hood**

Be sure to return the support rod to its clip before closing the hood. Closing the hood with the support rod not clipped could cause the hood to bend.

امداد خودرو فارما

تلفن شبانه روزی: ۰۲۱-۸۸۸۶۲۰۸۵

FarmaSOS.com

## Positioning a floor jack

When using a floor jack, follow the instructions in the manual provided with the jack and perform the operation safely.

When raising your vehicle with a floor jack, position the jack correctly. Improper placement may damage your vehicle or cause injury.

### ◆ Front

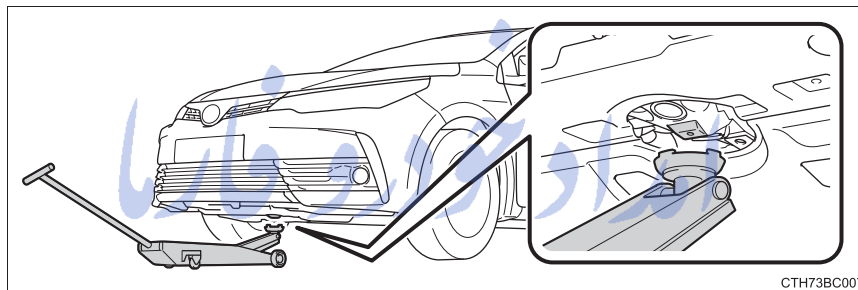

### ◆ Rear

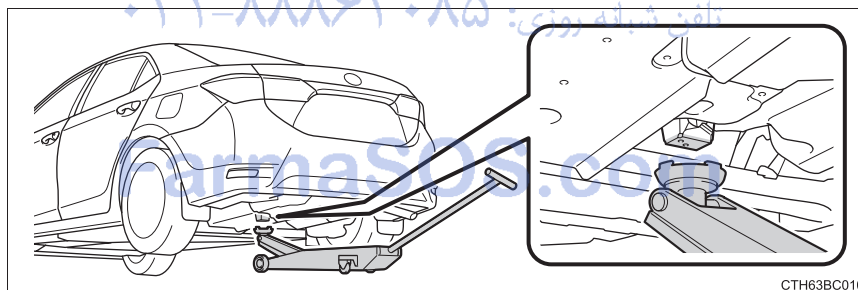

## Engine compartment

► 1NR-FE engine

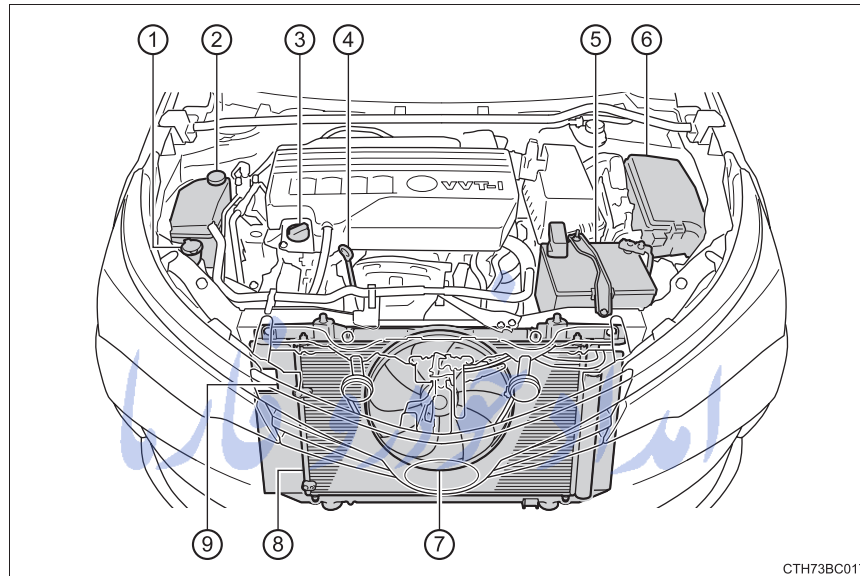

- |                                       |                        |
|---------------------------------------|------------------------|
| ① Washer fluid tank (→P. 457)         | ⑤ Battery (→P. 454)    |
| ② Engine coolant reservoir (→P. 452)  | ⑥ Fuse box (→P. 483)   |
| ③ Engine oil filler cap (→P. 449)     | ⑦ Electric cooling fan |
| ④ Engine oil level dipstick (→P. 447) | ⑧ Condenser (→P. 453)  |
|                                       | ⑨ Radiator (→P. 453)   |



## ▶ 1ZR-FAE engine

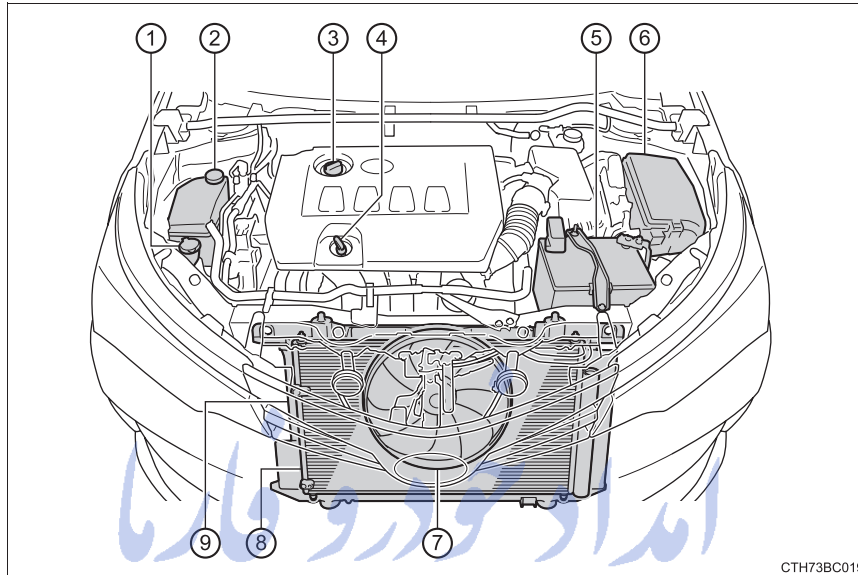

- |                                       |                        |
|---------------------------------------|------------------------|
| ① Washer fluid tank (→P. 457)         | ⑤ Battery (→P. 454)    |
| ② Engine coolant reservoir (→P. 452)  | ⑥ Fuse box (→P. 483)   |
| ③ Engine oil filler cap (→P. 449)     | ⑦ Electric cooling fan |
| ④ Engine oil level dipstick (→P. 447) | ⑧ Condenser (→P. 453)  |
|                                       | ⑨ Radiator (→P. 453)   |

► 1ND-TV engine

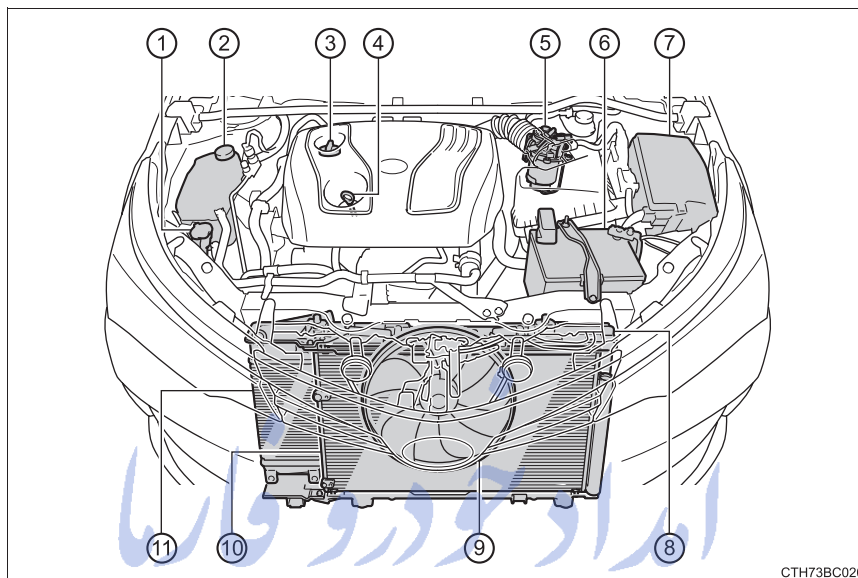

CTH73BC020

- |                                       |                         |
|---------------------------------------|-------------------------|
| ① Washer fluid tank (→P. 457)         | ⑤ Fuel filter (→P. 458) |
| ② Engine coolant reservoir (→P. 452)  | ⑥ Battery (→P. 454)     |
| ③ Engine oil filler cap (→P. 449)     | ⑦ Fuse box (→P. 483)    |
| ④ Engine oil level dipstick (→P. 447) | ⑧ Radiator (→P. 453)    |
|                                       | ⑨ Electric cooling fan  |
|                                       | ⑩ Condenser (→P. 453)   |
|                                       | ⑪ Intercooler (→P. 453) |

### Engine oil

With the engine at operating temperature and turned off, check the oil level on the dipstick.

#### ■ Checking the engine oil

- 1 Park the vehicle on level ground. After warming up the engine and turning it off, wait more than 5 minutes for the oil to drain back into the bottom of the engine.
- 2 Holding a rag under the end, pull the dipstick out.

##### ▶ 1NR-FE engine

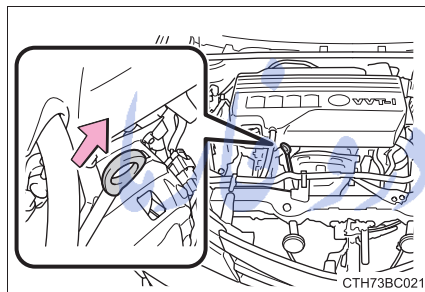

##### ▶ 1ZR-FAE engine

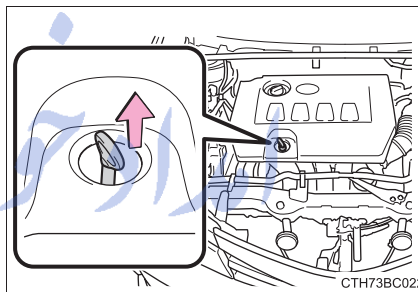

##### ▶ 1ND-TV engine

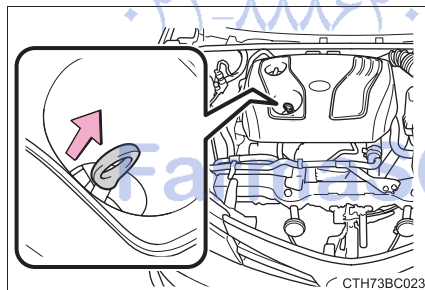

- 3 Wipe the dipstick clean.
- 4 Flat dipstick: Reinsert the dipstick fully.

- 4 Non-flat dipstick: Reinsert the non-flat dipstick fully with its protruding areas (1 in the illustration) pointing towards the engine.

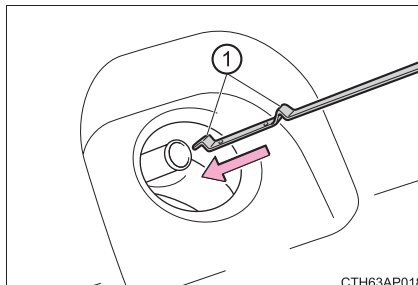

- 5 Holding a rag under the end, pull the dipstick out and check the oil level.

- 1 Low
- 2 Normal
- 3 Excessive

► Flat dipstick

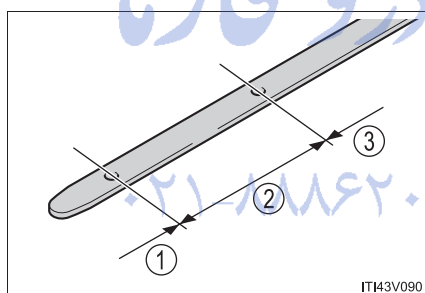

► Non-flat dipstick

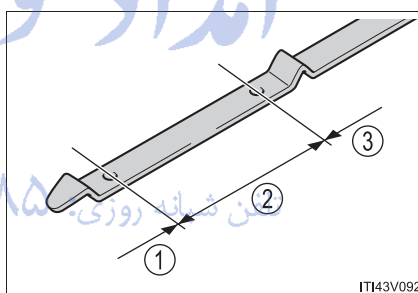

The shape of the dipstick may differ depending on the type of vehicle or engine.

- 6 Wipe the dipstick and reinsert it fully.

### ■ Adding engine oil

If the oil level is below or near the low level mark, add engine oil of the same type as that already in the engine.

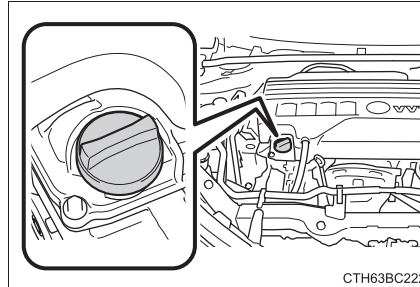

Make sure to check the oil type and prepare the items needed before adding oil.

Engine oil selection	→P. 598
Oil quantity (Low → Full)	<ul style="list-style-type: none"> <li>▶ 1ND-TV engine (except for Turkey) 1.3 L (1.4 qt., 1.1 Imp. qt.)</li> <li>▶ Others 1.5 L (1.6 qt., 1.3 Imp. qt.)</li> </ul>
Items	Clean funnel

- 1 Remove the oil filler cap by turning it counterclockwise.
- 2 Add engine oil slowly, checking the dipstick.
- 3 Install the oil filler cap by turning it clockwise.

FarmaSOS.com

**■ When adding engine oil (diesel engine only)**

Do not overfill the engine. Use the dipstick to ensure that the oil level does not exceed the full mark. If exceeded, the oil level will have to be adjusted to below the full mark.

**■ Engine oil consumption**

A certain amount of engine oil will be consumed while driving. In the following situations, oil consumption may increase, and engine oil may need to be refilled in between oil maintenance intervals.

- When the engine is new, for example directly after purchasing the vehicle or after replacing the engine
- If low quality oil or oil of an inappropriate viscosity is used
- When driving at high engine speeds or with a heavy load, when towing, or when driving while accelerating or decelerating frequently
- When leaving the engine idling for a long time, or when driving frequently through heavy traffic

**■ After changing the engine oil (diesel engine only)**

The engine oil maintenance data should be reset. Perform the following procedures:

▶ Vehicles with a drive monitor display

- 1 Switch the display to the trip meter "A" when the engine is running. (→P. 92)
- 2 Turn the engine switch off.
- 3 Vehicles without a smart entry & start system:  
While pressing the display change button (→P. 92), turn the engine switch to the "ON" position (do not start the engine because reset mode will be canceled). Continue to press and hold the button until the trip meter displays "000000".

Vehicles with a smart entry & start system:  
While pressing the display change button (→P. 92), turn the engine switch to the IGNITION ON mode (do not start the engine because otherwise the reset mode will be canceled). Continue to press and hold the button until the trip meter displays "000000".

► Vehicles with a multi-information display

1 Switch the display to the trip meter “A” when the engine is running.  
(→P. 103)

2 Turn the engine switch off.

3 Vehicles without a smart entry & start system:

While pressing the “TRIP” switch (→P. 103), turn the engine switch to the “ON” position (do not start the engine because reset mode will be canceled). Continue to press and hold the switch until the trip meter displays “00000”.

Vehicles with a smart entry & start system:

While pressing the “TRIP” switch (→P. 103), turn the engine switch to the IGNITION ON mode (do not start the engine because otherwise the reset mode will be canceled). Continue to press and hold the switch until the trip meter displays “00000”.

 WARNING

■ Used engine oil

- Used engine oil contains potentially harmful contaminants which may cause skin disorders such as inflammation and skin cancer, so care should be taken to avoid prolonged and repeated contact. To remove used engine oil from your skin, wash thoroughly with soap and water.
- Dispose of used oil and filters only in a safe and acceptable manner. Do not dispose of used oil and filters in household trash, in sewers or onto the ground.  
Call any authorized Toyota dealer or repairer, or another duly qualified and equipped professional, service station or auto parts store for information concerning recycling or disposal.
- Do not leave used engine oil within the reach of children.

 NOTICE

■ To prevent serious engine damage

Check the oil level on a regular basis.

■ When replacing the engine oil

- Be careful not to spill engine oil on the vehicle components.
- Avoid overfilling, or the engine could be damaged.
- Check the oil level on the dipstick every time you refill the vehicle.
- Be sure the engine oil filler cap is properly tightened.

■ Engine oil (diesel engine only)

Using an engine oil other than ACEA C2 may damage the catalytic converter.

### Engine coolant

The coolant level is satisfactory if it is between the “FULL” and “LOW” lines on the reservoir when the engine is cold.

- ① Reservoir cap
- ② “FULL” line
- ③ “LOW” line

If the level is on or below the “LOW” line, add coolant up to the “FULL” line.

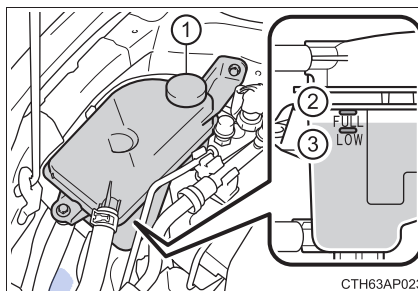

### ■ Coolant selection

Only use “Toyota Super Long Life Coolant” or a similar high quality ethylene glycol based non-silicate, non-amine, non-nitrite, and non-borate coolant with long-life hybrid organic acid technology.

“Toyota Super Long Life Coolant” is a mixture of 50% coolant and 50% deionized water. (Minimum temperature: -35°C [-31°F])

For more details about engine coolant, contact any authorized Toyota dealer or repairer, or another duly qualified and equipped professional.

### ■ If the coolant level drops within a short time of replenishing

Visually check the radiator, hoses, engine coolant reservoir caps, drain cock and water pump.

If you cannot find a leak, have any authorized Toyota dealer or repairer, or another duly qualified and equipped professional, test the cap and check for leaks in the cooling system.

### ⚠ WARNING

#### ■ When the engine is hot

Do not remove the engine coolant reservoir cap.

The cooling system may be under pressure and may spray hot coolant if the cap is removed, causing serious injuries, such as burns.



 NOTICE**■ When adding coolant**

Coolant is neither plain water nor straight antifreeze. The correct mixture of water and antifreeze must be used to provide proper lubrication, corrosion protection and cooling. Be sure to read the antifreeze or coolant label.

**■ If you spill coolant**

Be sure to wash it off with water to prevent it from damaging parts or paint.

**Radiator, condenser and intercooler**

Check the radiator, condenser and intercooler and clear away any foreign objects.

If any of the above parts are extremely dirty or you are not sure of their condition, have your vehicle inspected by any authorized Toyota dealer or repairer, or another duly qualified and equipped professional.

 WARNING**■ When the engine is hot**

Do not touch the radiator, condenser or intercooler as they may be hot and cause serious injuries, such as burns.







FarmaSOS.com

### Battery

Check the battery as follows.

#### ■ Caution symbols

The meanings of each caution symbol on the top of the battery are as follows:

	No smoking, no naked flames, no sparks		Battery acid
	Shield eyes		Note operating instructions
	Keep away from children		Explosive gas

#### ■ Battery exterior

Make sure that the battery terminals are not corroded and that there are no loose connections, cracks, or loose clamps.

- ① Terminals
- ② Hold-down clamp

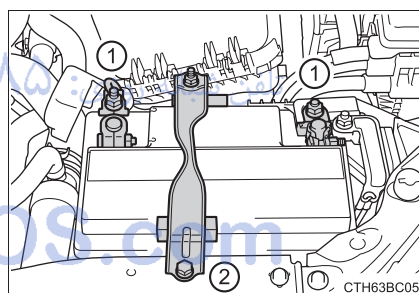

**■ Before recharging**

When recharging, the battery produces hydrogen gas which is flammable and explosive. Therefore, observe the following before recharging:

- If recharging with the battery installed on the vehicle, be sure to disconnect the ground cable.
- Make sure the power switch on the charger is off when connecting and disconnecting the charger cables to the battery.

**■ After recharging/reconnecting the battery (vehicles with a smart entry & start system)**

- Unlocking the doors using the smart entry & start system may not be possible immediately after reconnecting the battery. If this happens, use the wireless remote control or the mechanical key to lock/unlock the doors.
- Start the engine with the engine switch in ACCESSORY mode. The engine may not start with the engine switch turned off. However, the engine will operate normally from the second attempt.
- The engine switch mode is recorded by the vehicle. If the battery is reconnected, the vehicle will return the engine switch mode to the status it was in before the battery was disconnected. Make sure to turn off the engine before disconnect the battery. Take extra care when connecting the battery if the engine switch mode prior to discharge is unknown.

If the system will not start even after multiple attempts, contact any authorized Toyota dealer or repairer, or another duly qualified and equipped professional.

تلفن شبانه روزی: ۰۲۱-۸۸۸۶۲۰۸۵

FarmaSOS.com

 WARNING**■ Chemicals in the battery**

Batteries contain poisonous and corrosive sulfuric acid and may produce hydrogen gas which is flammable and explosive. To reduce the risk of death or serious injury, take the following precautions while working on or near the battery:

- Do not cause sparks by touching the battery terminals with tools.
- Do not smoke or light a match near the battery.
- Avoid contact with eyes, skin and clothes.
- Never inhale or swallow electrolyte.
- Wear protective safety glasses when working near the battery.
- Keep children away from the battery.

**■ Where to safely charge the battery**

Always charge the battery in an open area. Do not charge the battery in a garage or closed room where there is insufficient ventilation.

**■ How to recharge the battery**

Only perform a slow charge (5 A or less). The battery may explode if charged at a quicker rate.

**■ Emergency measures regarding electrolyte**

- If electrolyte gets in your eyes  
Flush your eyes with clean water for at least 15 minutes and get immediate medical attention. If possible, continue to apply water with a sponge or cloth while traveling to the nearest medical facility.
- If electrolyte gets on your skin  
Wash the affected area thoroughly. If you feel pain or burning, get medical attention immediately.
- If electrolyte gets on your clothes  
It can soak through clothing on to your skin. Immediately take off the clothing and follow the procedure above if necessary.
- If you accidentally swallow electrolyte  
Drink a large quantity of water or milk. Get emergency medical attention immediately.

 NOTICE**■ When recharging the battery**

Never recharge the battery while the engine is running. Also, be sure all accessories are turned off.

**Washer fluid**

## ▶ Type A

If the fluid level is extremely low add washer fluid.

Raise the cap keeping your finger pressed down on the hole in the center and check the fluid level in the tube.

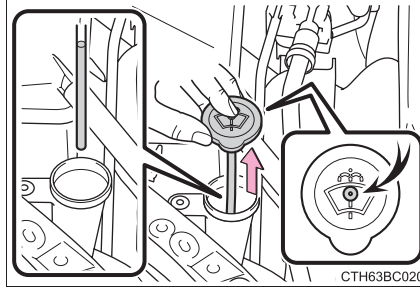

## ▶ Type B

Add washer fluid in the following situations:

- A washer does not work.
- Vehicles with a drive monitor display: The windshield low washer fluid warning light (if equipped) comes on. (→P. 517)
- Vehicles with a multi-information display: The warning message (if equipped) appears on the multi-information display.

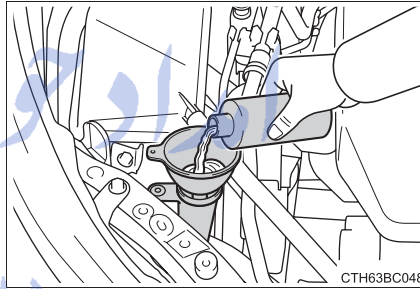
**⚠ WARNING****■ When adding washer fluid**

Do not add washer fluid when the engine is hot or running as washer fluid contains alcohol and may catch fire if spilled on the engine etc.

 NOTICE

■ **Do not use any fluid other than washer fluid**

Do not use soapy water or engine antifreeze instead of washer fluid. Doing so may cause streaking on the vehicle's painted surfaces.

■ **Diluting washer fluid**

Dilute washer fluid with water as necessary. Refer to the freezing temperatures listed on the label of the washer fluid bottle.

### Fuel filter (diesel engine only)

You may drain the fuel filter yourself. However, as the operation is difficult, we recommend having it drained by any authorized Toyota dealer or repairer, or another duly qualified and equipped professional. Even if you decide to drain it yourself, contact any authorized Toyota dealer or repairer, or another duly qualified and equipped professional.

▶ Vehicles with a drive monitor display

The water in the fuel filter needs to be drained if the fuel filter warning light comes on. (→P. 516)

▶ Vehicles with a multi-information display تلفن شبانه روزی ۰۲۱-۸۸۴۲۰۸۸

When the "Drain water from fuel filter." warning message is shown on the multi-information display. (→P. 526)

- 1 Vehicles without a smart entry & start system: Turn the engine switch to the "LOCK" position.  
Vehicles with a smart entry & start system: Turn the engine switch off.
- 2 Place a small tray under the drain plug to catch the water and any fuel that comes out.
- 3 Turn the drain plug counter-clockwise about 2 to 2 1/2 turns.

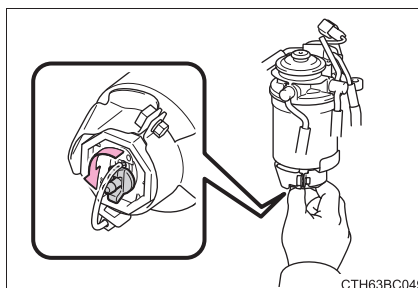

- 4 Operate the priming pump until fuel begins to run out.

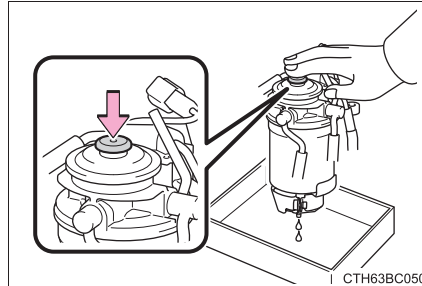

- 5 After draining, tighten the drain plug by hand.

امداد خودرو فارما

تلفن شبانه روزی: ۰۲۱-۸۸۸۶۲۰۸۵

FarmaSOS.com

## Tires

Replace or rotate tires in accordance with maintenance schedules and treadwear.

### Checking tires

Check if the treadwear indicators are showing on the tires. Also check the tires for uneven wear, such as excessive wear on one side of the tread.

Check the spare tire condition and pressure if not rotated.

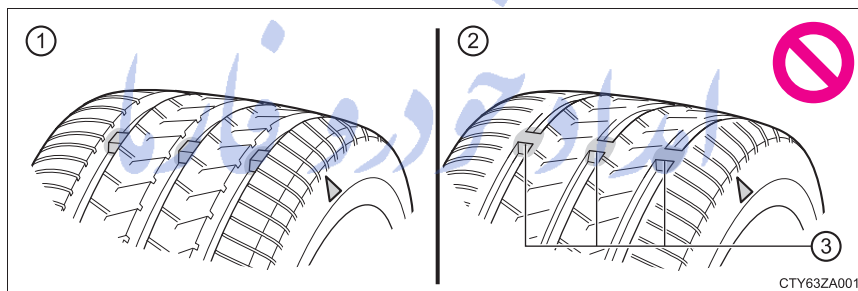

- ① New tread
- ② Worn tread
- ③ Treadwear indicator

The location of treadwear indicators is shown by a "TWI" or "Δ" mark, etc., molded into the sidewall of each tire.

Replace the tires if the treadwear indicators are showing on a tire.



### Tire rotation

Rotate the tires in the order shown.

To equalize tire wear and help extend tire life, Toyota recommends that you rotate your tires approximately every 10000 km (6000 miles).

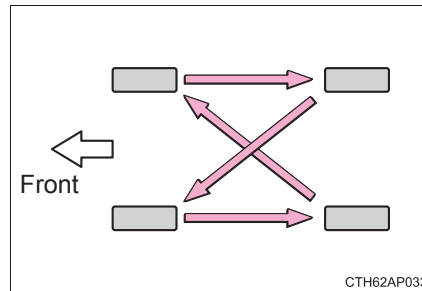

### Tire pressure warning system

Your vehicle is equipped with a tire pressure warning system that uses tire pressure warning valves and transmitters to detect low tire inflation pressure before serious problems arise. (→P. 519)

#### ◆ Installing tire pressure warning valves and transmitters

When replacing tires or wheels, tire pressure warning valves and transmitters must also be installed.

When new tire pressure warning valves and transmitters are installed, new ID codes must be registered in the tire pressure warning computer and the tire pressure warning system must be initialized. Have tire pressure warning valves and transmitter ID codes registered by any authorized Toyota dealer or repairer, or another duly qualified and equipped professional. (→P. 463)

### ◆ Initializing the tire pressure warning system

#### ■ The tire pressure warning system must be initialized in the following circumstances:

- When changing the tire size.
- When the tire inflation pressure is changed such as when changing traveling speed or load weight.

When the tire pressure warning system is initialized, the current tire inflation pressure is set as the benchmark pressure.

#### ■ How to initialize the tire pressure warning system

- 1 Park the vehicle in a safe place and turn the engine switch off.  
Initialization cannot be performed while the vehicle is moving.
- 2 Adjust the tire inflation pressure to the specified cold tire inflation pressure level. (→P. 606)  
Make sure to adjust the tire pressure to the specified cold tire inflation pressure level. The tire pressure warning system will operate based on this pressure level.
- 3 Turn the engine switch to the "ON" position (vehicles without a smart entry & start system) or engine switch to IGNITION ON mode (vehicles with a smart entry & start system).
- 4 Open the glove box. Press and hold the tire pressure warning reset switch until the tire pressure warning light blinks slowly 3 times.

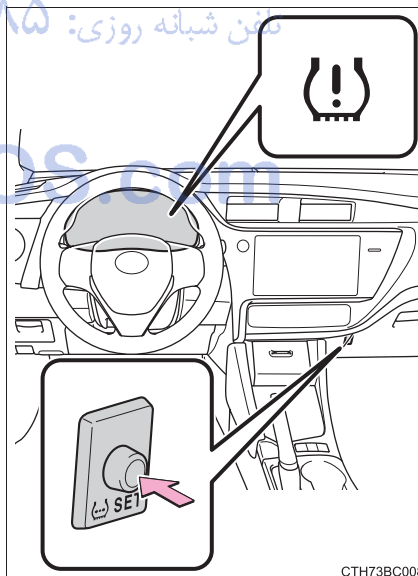

- 5 Vehicles without a smart entry & start system: Wait for a few minutes with the engine switch in the “ON” position and then turn the engine switch to the “ACC” or “LOCK” position.

Vehicles with a smart entry & start system: Wait for a few minutes with the engine switch in IGNITION ON mode and then turn the engine switch off.

#### ◆ Registering ID codes

The tire pressure warning valve and transmitter is equipped with a unique ID code. When replacing a tire pressure warning valve and transmitter, it is necessary to register the ID code. Have the ID code registered by any authorized Toyota dealer or repairer, or another duly qualified and equipped professional.

#### ■ When to replace your vehicle's tires

Tires should be replaced if:

- The treadwear indicators are showing on a tire.
- You have tire damage such as cuts, splits, cracks deep enough to expose the fabric, and bulges indicating internal damage
- A tire goes flat repeatedly or cannot be properly repaired due to the size or location of a cut or other damage

If you are not sure, consult with any authorized Toyota dealer or repairer, or another duly qualified and equipped professional.

#### ■ Replacing tires and wheels

If the ID code of the tire pressure warning valve and transmitter is not registered, the tire pressure warning system will not work properly. After driving for about 20 minutes, the tire pressure warning light blinks for 1 minute and stays on to indicate a system malfunction.

#### ■ Tire life

Any tire over 6 years old must be checked by a qualified technician even if it has seldom or never been used or damage is not obvious.

#### ■ Routine tire inflation pressure checks

The tire pressure warning system does not replace routine tire inflation pressure checks. Make sure to check tire inflation pressure as part of your routine of daily vehicle checks.

**■ Low profile tires (17-inch tires)**

Generally, low profile tires will wear more rapidly and tire grip performance will be reduced on snowy and/or icy roads when compared to standard tires. Be sure to use snow tires or tire chains\* on snowy and/or icy roads and drive carefully at a speed appropriate for road and weather conditions.

\*: Tire chains cannot be mounted on 215/45R17 tires.

**■ Initializing the tire pressure warning system**

Initialize the system with the tire inflation pressure adjusted to the specified level.

**■ If the tread on snow tires wears down below 4 mm (0.16 in.)**

The effectiveness of the tires as snow tires is lost.

**■ Conditions that the tire pressure warning system may not function properly**

The tire pressure warning system will be disabled in the following conditions: (When the condition becomes normal, the system will work properly.)

- If tires not equipped with tire pressure warning valves and transmitters are used
- If the ID code on the tire pressure warning valves and transmitters is not registered in the tire pressure warning computer
- If the tire inflation pressure is 500 kPa (5.1 kgf/cm<sup>2</sup> or bar, 73 psi) or higher

The tire pressure warning system may be disabled in the following conditions: (When the condition becomes normal, the system will work properly.)

- If electronic devices or facilities using similar radio wave frequencies are nearby
- If a radio set at similar frequency is in use in the vehicle
- If a window tint that affects the radio wave signals is installed
- If there is a lot of snow or ice on the vehicle, in particular around the wheels or wheel housings
- If non-genuine Toyota wheels are used (Even if you use Toyota wheels, the tire pressure warning system may not work properly with some types of tires.)
- If tire chains are used

**■ If you press the tire pressure warning reset switch accidentally**

If initialization is performed, adjust the tire inflation pressure to the specified level and initialize the tire pressure warning system again.

**■ When initialization of the tire pressure warning system has failed**

Initialization can be completed in a few minutes. However, in the following cases, the settings have not been recorded and the system will not operate properly. If repeated attempts to record tire inflation pressure settings are unsuccessful, have the vehicle inspected by any authorized Toyota dealer or repairer, or another duly qualified and equipped professional as soon as possible.

- When operating the tire pressure warning reset switch, the tire pressure warning light does not blink 3 times.
- After driving for a certain period of time since the initialization has been completed, the warning light comes on after blinking for 1 minute.

**■ Registering ID codes**

The ID codes of the tire pressure warning valve and transmitters for two sets of wheels can be registered.

It is not necessary to register the ID codes when replacing normal tires with snow tires, if the ID codes for the wheels of both normal tires and snow tires are registered beforehand.

For information about changing ID codes, ask any authorized Toyota dealer or repairer, or another duly qualified and equipped professional.

تلفن شبانه روزی: ۰۲۱-۸۸۸۶۲۰۸۵

FarmaSOS.com

■ Tire pressure warning system certification

► Transmitter

<p>The latest "DECLARATION of CONFORMITY "(DoC) is available at the following DoC address :  <a href="http://www.pacific-ind.co.jp/eng/products/car/tpms/doc/">http://www.pacific-ind.co.jp/eng/products/car/tpms/doc/</a></p>
<p><b>CE 0891</b></p>
<p>Hereby, PACIFIC INDUSTRIAL CO.,LTD., declares that this PMV-C210 is in compliance with the essential requirements and other relevant provisions of Directive 1999/5/EC.</p>
<p>PACIFIC INDUSTRIAL CO.,LTD. vakuuttaa täten että PMV-C210 tyyppinen laite on direktiivin 1999/5/EY oleellisten vaatimusten ja sitä koskevien direktiivin muiden ehtojen mukainen.</p>
<p>Hierbij verklaart PACIFIC INDUSTRIAL CO.,LTD. dat het toestel PMV-C210 in overeenstemming is met de essentiële eisen en de andere relevante bepalingen van richtlijn 1999/5/EG.</p>
<p>Par la présente PACIFIC INDUSTRIAL CO.,LTD. déclare que l'appareil PMV-C210 est conforme aux exigences essentielles et aux autres dispositions pertinentes de la directive 1999/5/CE.</p>
<p>Härmed intygar PACIFIC INDUSTRIAL CO.,LTD. att denna PMV-C210 står i överensstämmelse med de väsentliga egenskapskrav och övriga relevanta bestämmelser som framgår av direktiv 1999/5/EG</p>
<p>Undertegnede PACIFIC INDUSTRIAL CO.,LTD. erklærer herved, at følgende udstyr PMV-C210 overholder de væsentlige krav og øvrige relevante krav i direktiv 1999/5/EF.</p>
<p>Hiermit erklärt PACIFIC INDUSTRIAL CO.,LTD., dass sich das Gerät PMV-C210 in Übereinstimmung mit den grundlegenden Anforderungen und den übrigen einschlägigen Bestimmungen der Richtlinie 1999/5/EG befindet.</p>
<p>ΜΕ ΤΗΝ ΠΑΡΟΥΣΑ PACIFIC INDUSTRIAL CO.,LTD. ΔΗΛΩΝΕΙ ΟΤΙ PMV-C210 ΣΥΜΜΟΡΦΩΝΕΤΑΙ ΠΡΟΣ ΤΙΣ ΟΥΣΙΩΔΕΙΣ ΑΠΑΙΤΗΣΕΙΣ ΚΑΙ ΤΙΣ ΛΟΙΠΕΣ ΣΧΕΤΙΚΕΣ ΔΙΑΤΑΞΕΙΣ ΤΗΣ ΟΔΗΓΙΑΣ 1999/5/ΕΚ.</p>

<p>Con la presente PACIFIC INDUSTRIAL CO.,LTD. dichiara che questo PMV-C210 è conforme ai requisiti essenziali ed alle altre disposizioni pertinenti stabilite dalla direttiva 1999/5/CE.</p>
<p>Por medio de la presente PACIFIC INDUSTRIAL CO.,LTD. declara que el PMV-C210 cumple con los requisitos esenciales y cualesquiera otras disposiciones aplicables o exigibles de la Directiva 1999/5/CE.</p>
<p>PACIFIC INDUSTRIAL CO.,LTD. declara que este PMV-C210 está conforme com os requisitos essenciais e outras disposições da Directiva 1999/5/CE.</p>
<p>Hawnhekk, PACIFIC INDUSTRIAL CO.,LTD., jiddikjara li dan PMV-C210 jikkonforma mal-htigijiet essenzjali u ma provvedimenti oħrajn relevanti li hemm fid-Dirrettiva 1999/5/EC.</p>
<p>Käesolevaga kinnitab PACIFIC INDUSTRIAL CO.,LTD. seadme PMV-C210 vastavust direktiivi 1999/5/EÜ põhinõuetele ja nimetatud direktiivist tulenevatele teistele asjakohastele sätetele.</p>
<p>Alulfrott, PACIFIC INDUSTRIAL CO.,LTD. nyilatkozom, hogy a PMV-C210 megfelel a vonatkozó alapvető követelményeknek és az 1999/5/EC irányelv egyéb előírásainak.</p>
<p>PACIFIC INDUSTRIAL CO.,LTD. tímto vyhlasuje, že PMV-C210 splňa základné požiadavky a všetky príslušné ustanovenia Smernice 1999/5/ES.</p>
<p>PACIFIC INDUSTRIAL CO.,LTD. tímto prohlašuje, že tento PMV-C210 je ve shodě se základními požadavky a dalšími příslušnými ustanoveními směrnice 1999/5/ES.</p>
<p>PACIFIC INDUSTRIAL CO.,LTD. izjavlja, da je ta PMV-C210 v skladu z bistvenimi zahtevami in ostalimi relevantnimi določili direktive 1999/5/ES.</p>
<p>Šiuo PACIFIC INDUSTRIAL CO.,LTD. deklaruoja, kad šis PMV-C210 atitinka esminius reikalavimus ir kitas 1999/5/EB Direktyvos nuostatas.</p>

<p>Ar šo PACIFIC INDUSTRIAL CO.,LTD. deklarē, ka PMV-C210 atbilst Direktīvas 1999/5/EK būtiskajām prasībām un citiem ar to saistītajiem noteikumiem.</p>
<p>Niniejszym PACIFIC INDUSTRIAL CO.,LTD. oświadcza, że PMV-C210 jest zgodny z zasadniczymi wymogami oraz pozostałymi stosownymi postanowieniami Dyrektywy 1999/5/EC.</p>
<p>Hér með lýsir PACIFIC INDUSTRIAL CO.,LTD. yfir því að PMV-C210 er í samræmi við grunnkröfur og aðrar kröfur, sem gerðar eru í tilskipun 1999/5/EC.</p>
<p>PACIFIC INDUSTRIAL CO.,LTD. erklærer herved at utstyret PMV-C210 er i samsvar med de grunnleggende krav og øvrige relevante krav i direktiv 1999/5/EF.</p>
<p>С настояще то, PACIFIC INDUSTRIAL CO.,LTD., декларира, че PMV-C210 е в съответствие със съществените изисквания и другите приложими разпоредби на Директива 1999/5/ЕС.</p>
<p>Prin prezenta, PACIFIC INDUSTRIAL CO.,LTD., declară că aparatul PMV-C210 este în conformitate cu cerințele esențiale și cu alte prevederi pertinente ale Directivei 1999/5/CE.</p>
<p>Ovim , PACIFIC INDUSTRIAL CO.,LTD., izjavljuje da ovaj PMV-C210 je usklađen sa bitnim zahtjevima i drugim relevantnim odredbama Direktive 1999/5/EC.</p>
<p>Ovim, PACIFIC INDUSTRIAL CO.,LTD., deklarirše da je PMV-C210 u skladu sa osnovnim zahtevima i ostalim relevantnim odredbama Direktive 1999/5/EC.</p>
<p>Ovim PACIFIC INDUSTRIAL CO.,LTD., izjavljuje da je PMV-C210 u skladu s bitnim zahtjevima i drugim relevantnim odredbama Direktive 1999/5/EC.</p>
<p>Me anë të kësaj, PACIFIC INDUSTRIAL CO, LTD., Deklaron se ky PMV-C210 është në përputhje me kërkesat themelore dhe dispozitat e tjera përkatëse të direktivës 1999/5/EC.</p>



## ► Receiver

	<p>The latest "DECLARATION of CONFORMITY" (DoC) is available at the following address:  <a href="http://www.globaldenso.com/en/products/oem/index.html">http://www.globaldenso.com/en/products/oem/index.html</a></p>
<p>Hereby, DENSO CORPORATION declares that this 23AAM is in compliance with the essential requirements and other relevant provisions of Directive 1999/5/EC.</p>	
<p>DENSO CORPORATION vakuuttaa täten että 23AAM tyyppinen laite on direktiivin 1999/5/EY oleellisten vaatimusten ja sitä koskevien direktiivin muiden ehtojen mukainen.</p>	
<p>Hierbij verklaart DENSO CORPORATION dat het toestel 23AAM in overeenstemming is met de essentiële eisen en de andere relevante bepalingen van richtlijn 1999/5/EG.</p>	
<p>Par la présente DENSO CORPORATION déclare que l'appareil 23AAM est conforme aux exigences essentielles et aux autres dispositions pertinentes de la directive 1999/5/CE.</p>	
<p>Härmed intygar DENSO CORPORATION att denna 23AAM står i överensstämmelse med de väsentliga egenskapskrav och övriga relevanta bestämmelser som framgår av direktiv 1999/5/EG.</p>	
<p>Undertegnede DENSO CORPORATION erklærer herved, at følgende udstyr 23AAM overholder de væsentlige krav og øvrige relevante krav i direktiv 1999/5/EF.</p>	
<p>Hiermit erkläre DENSO CORPORATION, dass sich das Gerät 23AAM in Übereinstimmung mit den grundlegenden Anforderungen und den übrigen einschlägigen Bestimmungen der Richtlinie 1999/5/EG befindet.</p>	
<p>ΜΕ ΤΗΝ ΠΑΡΟΥΣΑ DENSO CORPORATION ΔΗΛΩΝΕΙ ΟΤΙ 23AAM ΣΥΜΜΟΡΦΩΝΕΤΑΙ ΠΡΟΣ ΤΙΣ ΟΥΣΙΩΔΕΙΣ ΑΠΑΙΤΗΣΕΙΣ ΚΑΙ ΤΙΣ ΛΟΙΠΕΣ ΣΧΕΤΙΚΕΣ ΔΙΑΤΑΞΕΙΣ ΤΗΣ ΟΔΗΓΙΑΣ 1999/5/ΕΚ.</p>	
<p>Con la presente DENSO CORPORATION dichiara che questo 23AAM è conforme ai requisiti essenziali ed alle altre disposizioni pertinenti stabilite dalla direttiva 1999/5/CE.</p>	
<p>Por medio de la presente DENSO CORPORATION declara que el 23AAM cumple con los requisitos esenciales y cualesquiera otras disposiciones aplicables o exigibles de la Directiva 1999/5/CE.</p>	
<p>DENSO CORPORATION declara que este 23AAM está conforme com os requisitos essenciais e outras disposições da Directiva 1999/5/CE.</p>	
<p>Hawnhekk, DENSO CORPORATION, jiddikjara li dan 23AAM jikkonforma mal-htigijiet essenzjali u ma provvedimenti oħrajn rilevanti li hemm fid-Direttiva 1999/5/EC.</p>	
<p>Käesolevaga kinnitab DENSO CORPORATION seadme 23AAM vastavust direktiivi 1999/5/EÜ põhinõuetele ja nimetatud direktiivist tulenevatele teistele asjakohastele sätetele.</p>	
<p>Alulírott, DENSO CORPORATION nyilatkozom, hogy a 23AAM megfelel a vonatkozó alapvető követelményeknek és az 1999/5/EC irányelv egyéb előírásainak.</p>	
<p>DENSO CORPORATION týmto vyhlasuje, že 23AAM spĺňa základné požiadavky a všetky príslušné ustanovenia Smernice 1999/5/ES.</p>	
<p>DENSO CORPORATION tímto prohlašuje, že tento 23AAM je ve shodě se základními požadavky a dalšími příslušnými ustanoveními směrnice 1999/5/ES.</p>	

DENSO CORPORATION izjavlja, da je ta 23AAM v skladu z bistvenimi zahtevami in ostalimi relevantnimi določili direktive 1999/5/ES.
Šiuo DENSO CORPORATION deklaruoja, kad šis 23AAM atitinka esminius reikalavimus ir kitas 1999/5/EB Direktyvos nuostatas.
Ar šo DENSO CORPORATION deklarē, ka 23AAM atbilst Direktīvas 1999/5/EK būtiskajām prasībām un citiem ar to saistītajiem noteikumiem.
Niniejszym DENSO CORPORATION oświadcza, że 23AAM jest zgodny z zasadniczymi wymogami oraz pozostałymi stosownymi postanowieniami Dyrektywy 1999/5/EC.
Hér með lýsir DENSO CORPORATION yfir því að 23AAM er í samræmi við grunnkröfur og aðrar kröfur, sem gerðar eru í tilskipun 1999/5/EC.
DENSO CORPORATION erklærer herved at utstyret 23AAM er i samsvar med de grunnleggende krav og øvrige relevante krav i direktiv 1999/5/EF.
С настоящето, DENSO CORPORATION, декларира, че 23AAM е в съответствие със съществените изисквания и другите приложими разпоредби на Директива 1999/5/EC.
Prin prezenta, DENSO CORPORATION, declară că aparatul 23AAM este în conformitate cu cerințele esențiale și cu alte prevederi pertinente ale Directivei 1999/5/CE.
Ovim, DENSO CORPORATION, izjavljuje da ovaj 23AAM je usklađen sa bitnim zahtjevima i drugim relevantnim odredbama Direktive 1999/5/EC.
Ovim, DENSO CORPORATION, deklarirše da je 23AAM u skladu sa osnovnim zahtevima i ostalim relevantnim odredbama Direktive 1999/5/EC.
Ovim DENSO CORPORATION, izjavljuje da je 23AAM u skladu s bitnim zahtjevima i drugim relevantnim odredbama Direktive 1999/5/EC i Pravilnika o RITT opremi (NN 25/2012).
Nepermjjet kesaj, DENSO CORPORATION, deklarorj qe ky 23AAM eshte ne pajtim me kerkesat thelbesore dhe dispozitat e tjera perkatese te Direktives 1999/5/EC.

FarmaSOS.com

 **WARNING****■ When inspecting or replacing tires**

Observe the following precautions to prevent accidents. Failure to do so may cause damage to parts of the drive train as well as dangerous handling characteristics, which may lead to an accident resulting in death or serious injury.

- Do not mix tires of different makes, models or tread patterns. Also, do not mix tires of remarkably different treadwear.
- Do not use tire sizes other than those recommended by Toyota.
- Do not mix differently constructed tires (radial, bias-belted or bias-ply tires).
- Do not mix summer, all season and snow tires.
- Do not use tires that have been used on another vehicle. Do not use tires if you do not know how they were used previously.
- Do not tow if your vehicle has a compact spare tire (if equipped) installed.
- Do not tow anything if a tire that has been repaired using the emergency tire puncture repair kit (if equipped) is installed. The load on the tire may cause unexpected damage to the tire.

**■ When initializing the tire pressure warning system**

Do not operate the tire pressure warning reset switch without first adjusting the tire inflation pressure to the specified level. Otherwise, the tire pressure warning light may not come on even if the tire inflation pressure is low, or it may come on when the tire inflation pressure is actually normal.

FarmaSOS.com

7

Maintenance and care

 NOTICE**■ Repairing or replacing tires, wheels, tire pressure warning valves, transmitters and tire valve caps**

- When removing or fitting the wheels, tires or the tire pressure warning valves and transmitters, contact any authorized Toyota dealer or repairer, or another duly qualified and equipped professional as the tire pressure warning valves and transmitters may be damaged if not handled correctly.
- When replacing tire valve caps, do not use tire valve caps other than those specified. The cap may become stuck.

**■ To avoid damage to the tire pressure warning valves and transmitters**

When a tire is repaired with liquid sealants, the tire pressure warning valve and transmitter may not operate properly. If a liquid sealant is used, contact any authorized Toyota dealer or repairer, or another duly qualified and equipped professional or other qualified service shop as soon as possible. After use of liquid sealant, make sure to replace the tire pressure warning valve and transmitter when repairing or replacing the tire. (→P. 461)

**■ Driving on rough roads**

Take particular care when driving on roads with loose surfaces or potholes. These conditions may cause losses in tire inflation pressure, reducing the cushioning ability of the tires. In addition, driving on rough roads may cause damage to the tires themselves, as well as the vehicle's wheels and body.

**■ Low profile tires (17-inch tires)**

Low profile tires may cause greater damage than usual to the tire wheel when sustaining impact from the road surface. Therefore, pay attention to the following:

- Be sure to use proper tire inflation pressure. If tires are under-inflated, they may be damaged more severely.
- Avoid potholes, uneven pavement, curbs and other road hazards. Failure to do so may lead to severe tire and wheel damage.

**■ If tire inflation pressure of each tire becomes low while driving**

Do not continue driving, or your tires and/or wheels may be ruined.

## Tire inflation pressure

**Make sure to maintain proper tire inflation pressure. Tire inflation pressure should be checked at least once per month. However, Toyota recommends that tire inflation pressure be checked once every two weeks. (→P. 606)**

### Tire-loading information label

Tire inflation pressure is specified on the label on the driver's side pillar as shown.

▶ Left-hand drive vehicles

▶ Right-hand drive vehicles

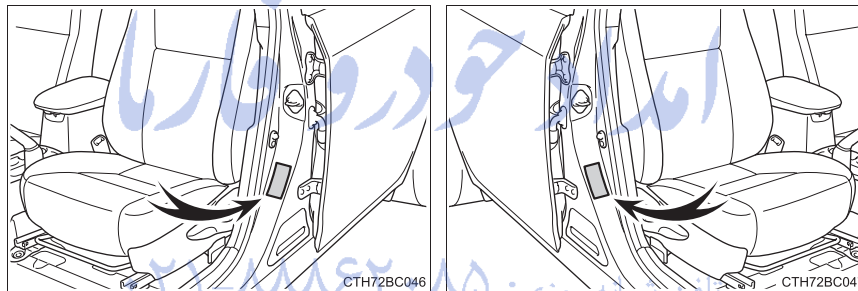

### ■ Effects of incorrect tire inflation pressure

Driving with incorrect tire inflation pressure may result in the following:

- Reduced fuel economy
- Reduced driving comfort and poor handling
- Reduced tire life due to wear
- Reduced safety
- Damage to the drive train

If a tire needs frequent inflating, have it checked by any authorized Toyota dealer or repairer, or another duly qualified and equipped professional.

**■ Instructions for checking tire inflation pressure**

When checking tire inflation pressure, observe the following:

- Check only when the tires are cold.  
If your vehicle has been parked for at least 3 hours or has not been driven for more than 1.5 km or 1 mile, you will get an accurate cold tire inflation pressure reading.
- Always use a tire pressure gauge.  
It is difficult to judge if a tire is properly inflated based only on its appearance.
- It is normal for the tire inflation pressure to be higher after driving as heat is generated in the tire. Do not reduce tire inflation pressure after driving.
- Passengers and luggage weight should be placed so that the vehicle is balanced.

**⚠ WARNING****■ Proper inflation is critical to save tire performance**

Keep your tires properly inflated.

If the tires are not properly inflated, the following conditions may occur which could lead to an accident resulting in death or serious injury:

- Excessive wear
- Uneven wear
- Poor handling
- Possibility of blowouts resulting from overheated tires
- Air leaking from between tire and wheel
- Wheel deformation and/or tire damage
- Greater possibility of tire damage while driving (due to road hazards, expansion joints, sharp edges in the road, etc.)

**⚠ NOTICE****■ When inspecting and adjusting tire inflation pressure**

Be sure to put the tire valve caps back on.

If a valve cap is not installed, dirt or moisture may get into the valve and cause an air leak, resulting in decreased tire inflation pressure.

## Wheels

**If a wheel is bent, cracked or heavily corroded, it should be replaced. Otherwise, the tire may separate from the wheel or cause a loss of handling control.**

### Wheel selection

When replacing wheels, care should be taken to ensure that they are equivalent to those removed in load capacity, diameter, rim width and inset\*.

Replacement wheels are available at any authorized Toyota dealer or repairer, or another duly qualified and equipped professional.

\*: Conventionally referred to as "offset".

Toyota does not recommend using the following:

- Wheels of different sizes or types
- Used wheels
- Bent wheels that have been straightened

### Aluminum wheel precautions (if equipped)

- Use only Toyota wheel nuts and wrenches designed for use with your aluminum wheels.
- When rotating, repairing or changing your tires, check that the wheel nuts are still tight after driving 1600 km (1000 miles).
- Be careful not to damage the aluminum wheels when using tire chains.
- Use only Toyota genuine balance weights or equivalent and a plastic or rubber hammer when balancing your wheels.

### When replacing wheels

The wheels of your vehicle are equipped with tire pressure warning valves and transmitters that allow the tire pressure warning system to provide advance warning in the event of a loss in tire inflation pressure. Whenever wheels are replaced, tire pressure warning valves and transmitters must be installed. (→P. 461)

■ **When removing the wheel ornament (vehicles with the wheel cap clip)**

Remove the wheel ornament using the wheel cap clip.

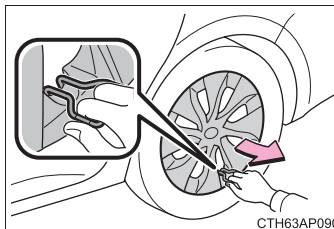

CTH63AP090

**⚠ WARNING**

■ **When replacing wheels**

- Do not use wheels that are a different size from those recommended in the Owner's Manual, as this may result in a loss of handling control.
- Never use an inner tube in a leaking wheel which is designed for a tubeless tire. Doing so may result in an accident, causing death or serious injury.

■ **When installing the wheel nuts**

- Be sure to install the wheel nuts with the tapered ends facing inward. Installing the nuts with the tapered ends facing outward can cause the wheel to break and eventually cause the wheel to come off while driving, which could lead to an accident resulting in death or serious injury.

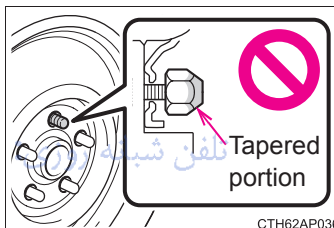

CTH62AP036

- Never use oil or grease on the wheel bolts or wheel nuts. Oil and grease may cause the wheel nuts to be excessively tightened, leading to bolt or disc wheel damage. In addition, the oil or grease can cause the wheel nuts to loosen and the wheel may fall off, causing an accident and resulting in death or serious injury. Remove any oil or grease from the wheel bolts or wheel nuts.

■ **Use of defective wheels prohibited**

Do not use cracked or deformed wheels. Doing so could cause the tire to leak air during driving, possibly causing an accident.



 NOTICE**■ Replacing tire pressure warning valves and transmitters**

- Because tire repair or replacement may affect the tire pressure warning valves and transmitters, make sure to have tires serviced by any authorized Toyota dealer or repairer, or another duly qualified and equipped professional or other qualified service shop. In addition, make sure to purchase your tire pressure warning valves and transmitters at any authorized Toyota dealer or repairer, or another duly qualified and equipped professional.
- Ensure that only genuine Toyota wheels are used on your vehicle. Tire pressure warning valves and transmitters may not work properly with non-genuine wheels.

امداد خودرو فارما

تلفن شبانه روزی: ۰۲۱-۸۸۸۶۲۰۸۵

FarmaSOS.com

## Air conditioning filter

The air conditioning filter must be changed regularly to maintain air conditioning efficiency.

### Removal method

- 1 Turn the engine switch off.
- 2 Open the glove box. Slide off the damper.

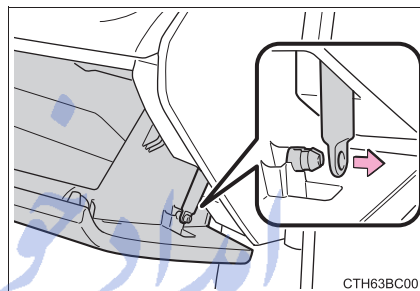

- 3 Push in the glove box on the vehicle's outer side to disconnect the claws. Then pull out the glove box and disconnect the lower claws.

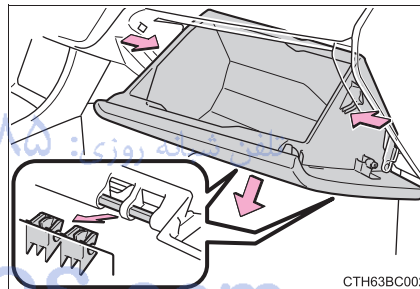

- 4 Remove the filter cover.

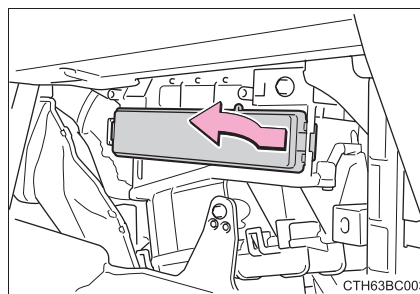

### ■ Replacement method

Remove the air conditioning filter and replace it with a new one.

The “↑UP” marks shown on the filter should be pointing up.

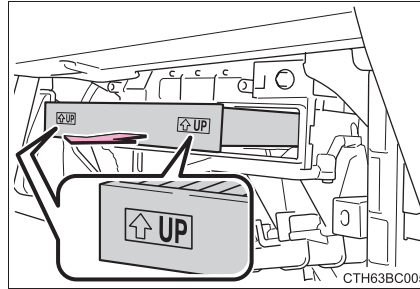

### ■ Checking interval

Inspect and replace the air conditioning filter according to the maintenance schedule. In dusty areas or areas with heavy traffic flow, early replacement may be required. (For scheduled maintenance information, please refer to the “Toyota Service Booklet” or “Toyota Warranty Booklet”.)

### ■ If air flow from the vents decreases dramatically

The filter may be clogged. Check the filter and replace if necessary.

#### ⚠ NOTICE

#### ■ When using the air conditioning system

Make sure that a filter is always installed.  
Using the air conditioning system without a filter may cause damage to the system.

FarmaSOS.com

## Wireless remote control/electronic key battery

Replace the battery with a new one if it is depleted or “Key battery low.” is displayed on the multi-information display (vehicles with a multi-information display).

### You will need the following items:

- Flathead screwdriver
- Small flathead screwdriver
- Lithium battery CR2016 (vehicles without a smart entry & start system), or CR2032 (vehicles with a smart entry & start system)

### Replacing the battery

- ▶ Vehicles without a smart entry & start system

- 1 Remove the cover.

To prevent damage to the key, cover the tip of the screwdriver with a rag.

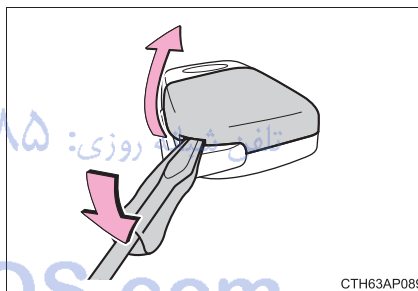

- 2 Remove the depleted battery.

Insert a new battery with the “+” terminal facing up.

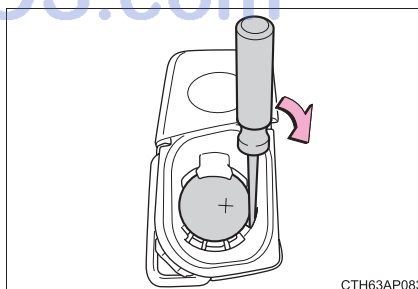

► Vehicles with a smart entry & start system

- 1 Release the lock and take out the mechanical key.

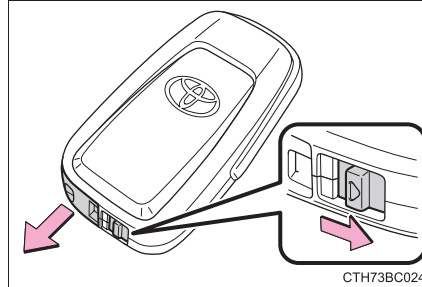

- 2 Remove the cover.

To prevent damage to the key, cover the tip of the screwdriver with a rag.

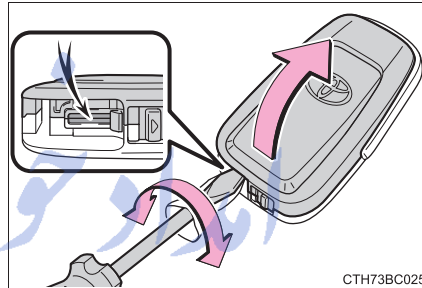

- 3 Remove the depleted battery.

When removing the cover, if the battery cannot be seen due to the electronic key module attaching to the upper cover, remove the electronic key module from the cover so that the battery is visible as shown in the illustration.

Insert a new battery with the “+” terminal facing up.

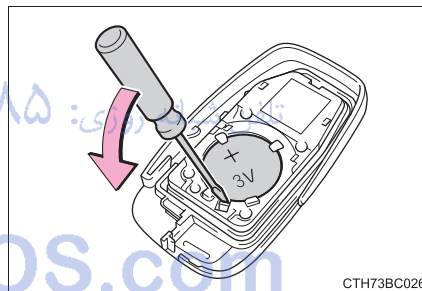

■ **Use a CR2016 (vehicles without a smart entry & start system) or CR2032 (vehicles with a smart entry & start system) lithium battery**

- Batteries can be purchased at any authorized Toyota dealer or repairer, or another duly qualified and equipped professional, local electrical appliance shops or camera stores.
- Replace only with the same or equivalent type recommended by the manufacturer.
- Dispose of used batteries according to local laws.

■ **If the key battery is depleted**

The following symptoms may occur:

- The smart entry & start system (if equipped) and wireless remote control will not function properly.
- The operational range will be reduced.

 **WARNING**

■ **Removed battery and other parts**

These parts are small and if swallowed by a child, they can cause choking. Keep away from children. Failure to do so could result in death or serious injury.

■ **Certification for the lithium battery**

CAUTION: RISK OF EXPLOSION IF BATTERY IS REPLACED BY AN INCORRECT TYPE. DISPOSE OF USED BATTERIES ACCORDING TO THE INSTRUCTIONS

 **NOTICE**

■ **For normal operation after replacing the battery**

Observe the following precautions to prevent accidents:

- Always work with dry hands.  
Moisture may cause the battery to rust.
- Do not touch or move any other component inside the remote control.
- Do not bend either of the battery terminals.

## Checking and replacing fuses

If any of the electrical components do not operate, a fuse may have blown. If this happens, check and replace the fuses as necessary.

- 1 Turn the engine switch off.
- 2 Open the fuse box cover.

► Engine compartment

Push the tab in and lift the lid off.

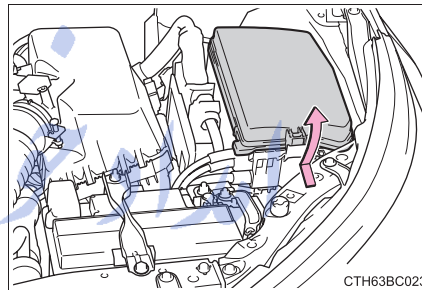

تلفن شبانه روزی: ۰۲۱-۸۸۸۶۲۰۸۵

FarmaSOS.com

► Driver's side instrument panel (left-hand drive vehicles)

Under the lower instrument panel:

Remove the lid.

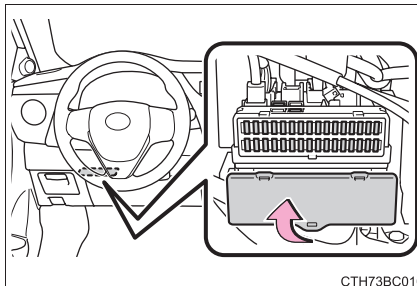

Behind the auxiliary box:

- ① Open the auxiliary box. Push in each side of the auxiliary box to disconnect the upper claws.
- ② Pull out the auxiliary box and disconnect the lower claws.

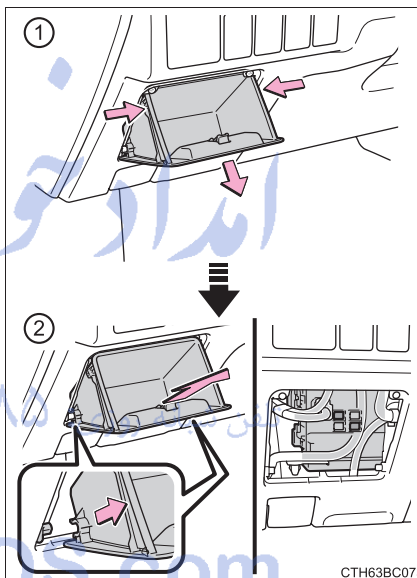



► Passenger's side instrument panel (right-hand drive vehicles)

Under the lower instrument panel:

Remove the cover and the lid.

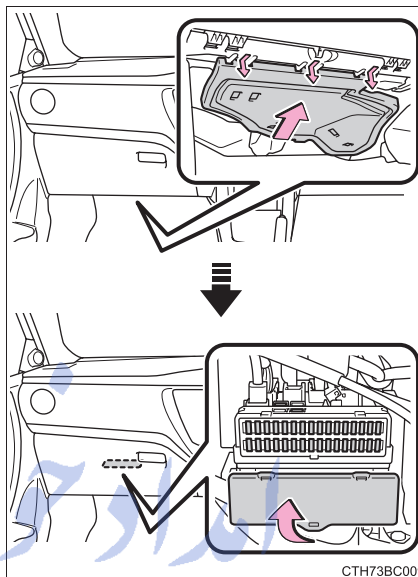

Behind the glove box:

- ① Open the glove box. Slide off the damper.
- ② Push in each side of the glove box disconnect the upper claws. Then pull out the glove box and disconnect the lower claws.

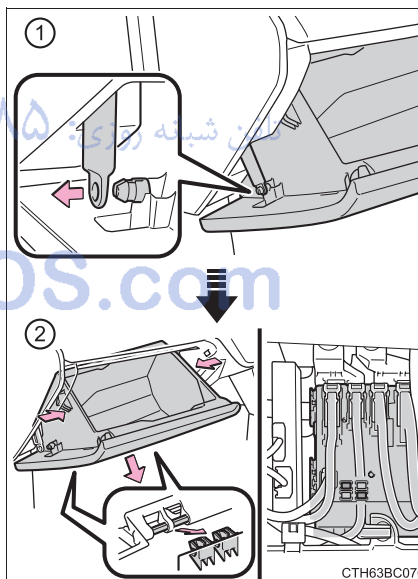

- 3 Remove the fuse with the pull-out tool.

Only type A fuses can be removed using the pullout tool.

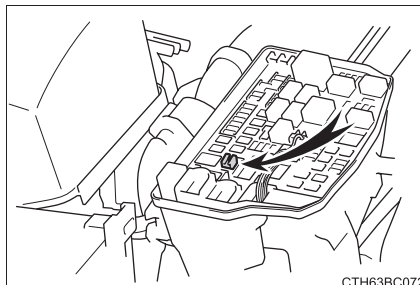

- 4 Check if the fuse is blown.

- ① Normal fuse
- ② Blown fuse

Replace the blown fuse with a new fuse of an appropriate amperage rating. The amperage rating can be found on the fuse box lid.

► Type A

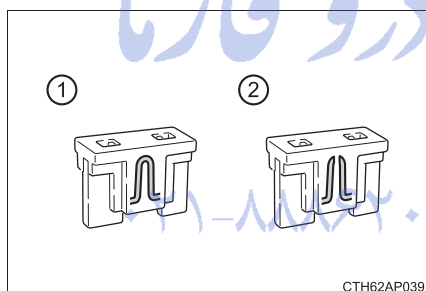

► Type B

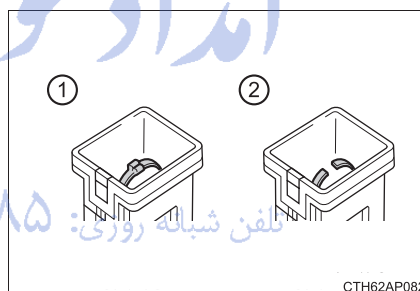

► Type C

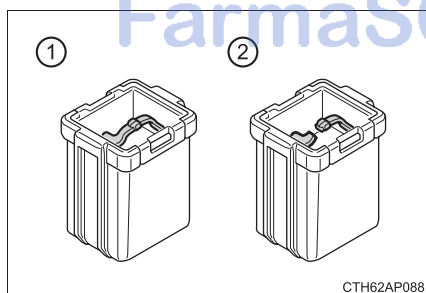

#### ■ After a fuse is replaced

- If the lights do not turn on even after the fuse has been replaced, a bulb may need replacement. (→P. 488)
- If the replaced fuse blows again, have the vehicle inspected by any authorized Toyota dealer or repairer, or another duly qualified and equipped professional.

#### ■ If there is an overload in a circuit

The fuses are designed to blow, protecting the wiring harness from damage.

#### WARNING

##### ■ To prevent system breakdowns and vehicle fire

Observe the following precautions.

Failure to do so may cause damage to the vehicle, and possibly a fire or injury.

- Never use a fuse of a higher amperage rating than that indicated, or use any other object in place of a fuse.
- Always use a genuine Toyota fuse or equivalent.  
Never replace a fuse with a wire, even as a temporary fix.
- Do not modify the fuses or fuse boxes.

#### NOTICE

##### ■ Before replacing fuses

Have the cause of electrical overload determined and repaired by any authorized Toyota dealer or repairer, or another duly qualified and equipped professional as soon as possible.

## Light bulbs

You may replace the following bulbs by yourself. The difficulty level of replacement varies depending on the bulb. As there is a danger that components may be damaged, we recommend that replacement is carried out by any authorized Toyota dealer or repairer, or another duly qualified and equipped professional.

### Preparing for light bulb replacement

Check the wattage of the light bulb to be replaced. (→P. 608)

### Bulb locations

#### ■ Front

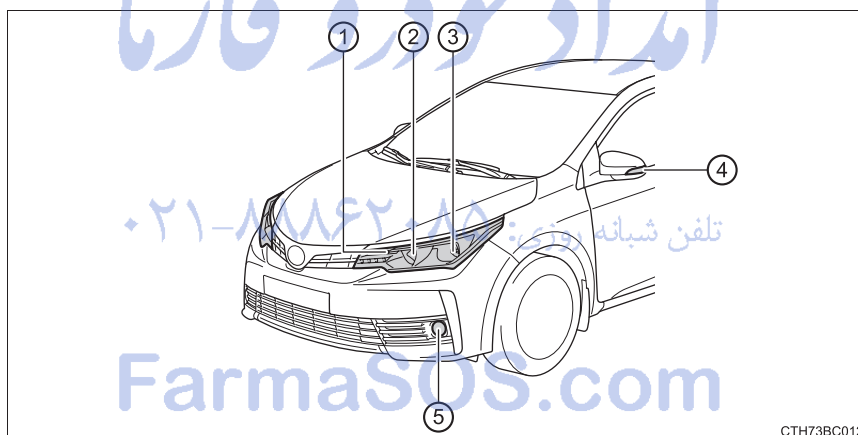

- ① Front turn signal light
- ② Headlight high beam (bulb type)
- ③ Headlight low beam (bulb type)
- ④ Side turn signal light
- ⑤ Front fog light (if equipped)

CTH73BC012

## ■ Rear

### ▶ Left-hand drive vehicles

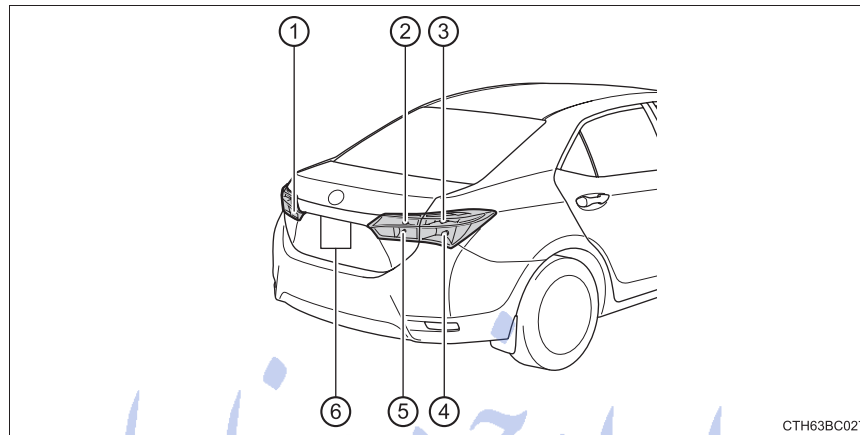

### ▶ Right-hand drive vehicles

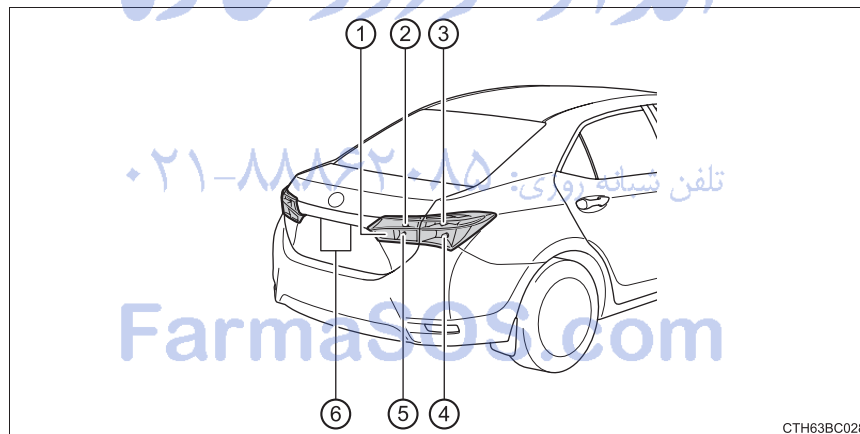

- ① Rear fog light (bulb type)
- ② Back-up light
- ③ Rear turn signal light
- ④ Stop/tail light (bulb type)
- ⑤ Tail light (bulb type)
- ⑥ License plate light

**Replacing light bulbs****■ Headlight low beams (bulb type)**

- 1 Turn the bulb base counter-clockwise.

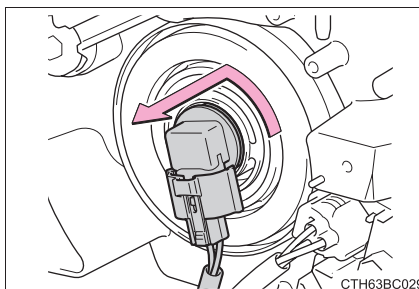

- 2 Pull the bulb out while pressing the lock release of the connector.

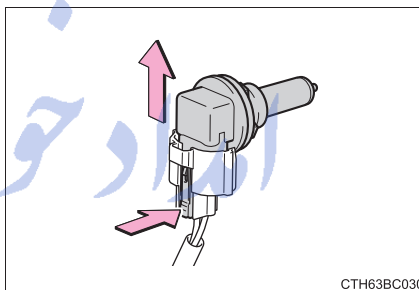

- 3 Replace the light bulb, and install the bulb base.

Align the 3 tabs on the light bulb with the mounting and insert.

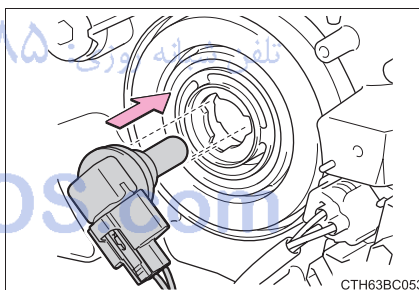

- 4 Turn and secure the bulb base.

Shake the bulb base gently to check that it is not loose, turn the headlights on once and visually confirm that no light is leaking through the mounting.

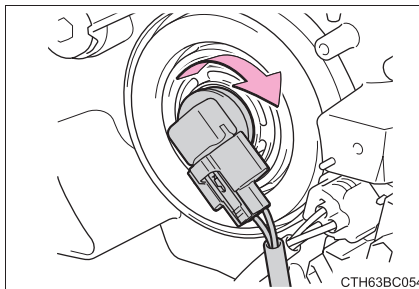

### ■ Headlight high beams (bulb type)

- 1 Turn the bulb base counter-clockwise.

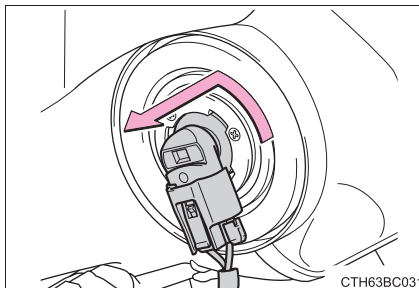

- 2 Pull the bulb out while pressing the lock release of the connector.

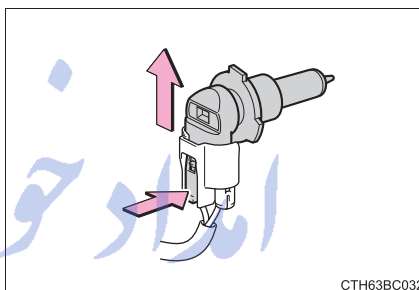

- 3 Replace the light bulb, and install the bulb base.

Align the 3 tabs on the light bulb with the mounting and insert.

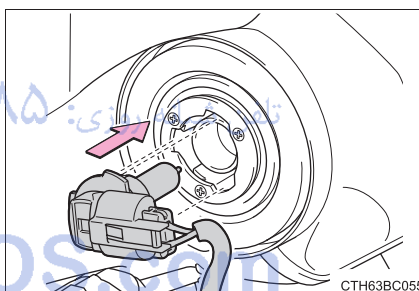

- 4 Turn and secure the bulb base.

Shake the bulb base gently to check that it is not loose, turn the headlights on once and visually confirm that no light is leaking through the mounting.

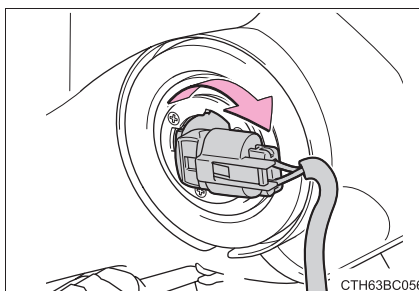

■ Front fog light (if equipped)

- 1 Remove the fender liner bolts and clip.

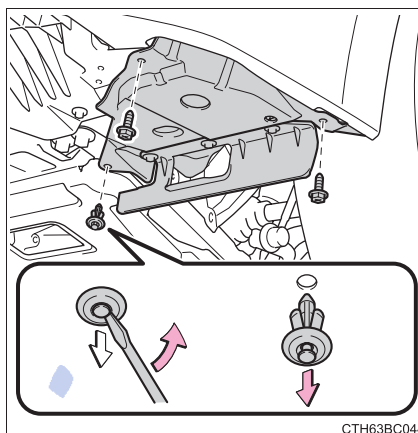

- 2 Remove the fender liner.

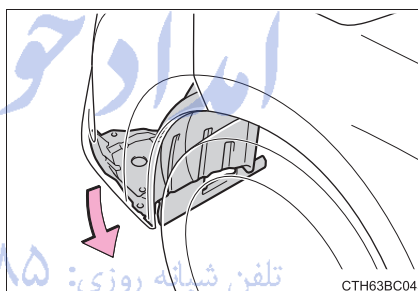

- 3 Unplug the connector while depressing the lock release.

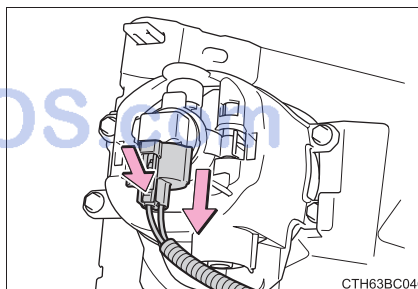

- 4 Turn the bulb base counter-clockwise.

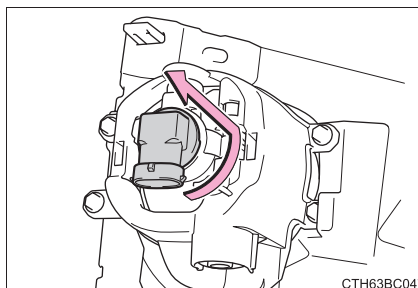



**5** Install a new light bulb.

Align the 3 tabs on the light bulb with the mounting and insert.  
Turn clockwise and secure the bulb base.

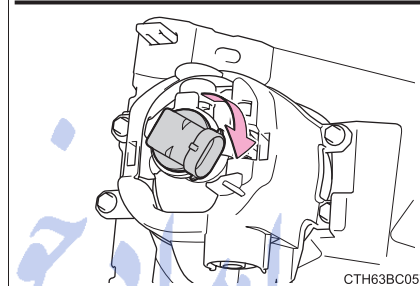
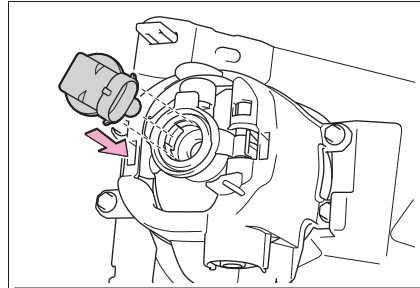
**6** Install the connector.

Shake the connector gently to check that it is not loose, turn the front fog lights on once and visually confirm that no light is leaking through the mounting.

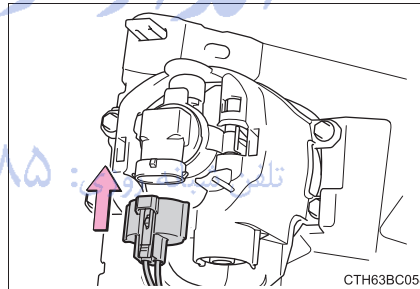
**7** When installing the fender liner, install by conducting **2** and **1** with the directions reversed.

Make sure that the fender liner is attached to the inside of the bumper.

■ Front turn signal light

- 1 Turn the bulb base counter-clockwise.

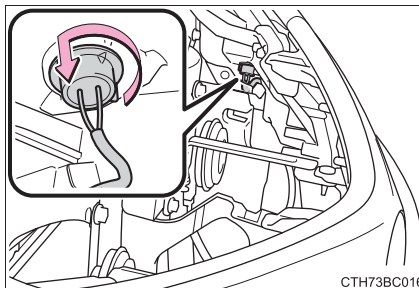

- 2 Remove the light bulb.

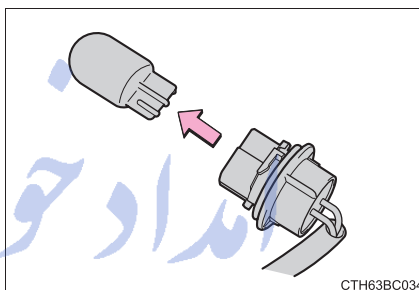

- 3 When installing, reverse the steps listed.

تلفن شبانه روزی: ۰۲۱-۸۸۸۶۲۰۸۵

FarmaSOS.com

### ■ Stop/tail light (bulb type) and rear turn signal light

- 1 Open the trunk lid and remove the clips.

To prevent damage to the vehicle, cover the tip of the screwdriver with a rag.

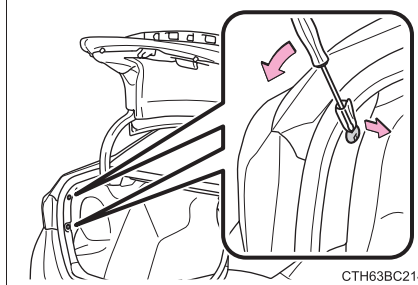

- 2 Partly remove the luggage trim cover.

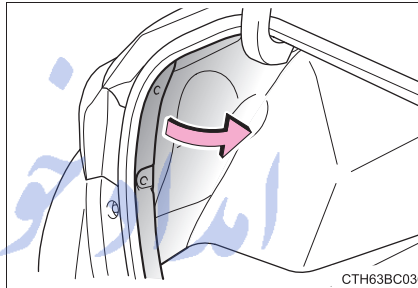

- 3 Turn the bulb base counter-clockwise.

- ① Rear turn signal light  
② Stop/tail light

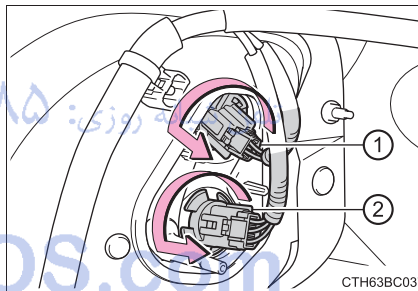

- 4 Remove the light bulb.

- ① Rear turn signal light  
② Stop/tail light

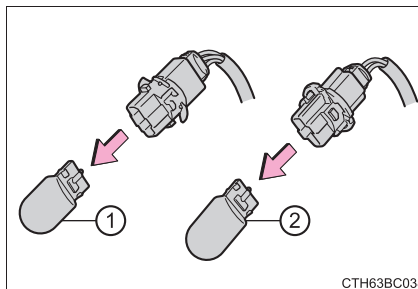

- 5 When installing, reverse the steps listed.

### ■ Rear fog light (bulb type), tail light (bulb type) and back-up light

- 1 Open the trunk lid and remove the clip. Then partly remove the trunk panel cover.

To prevent damage to the vehicle, cover the tip of the screwdriver with a rag.

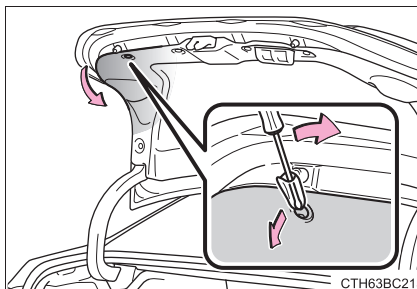

- 2 Turn the bulb base counter-clockwise.

- ① Tail light
- ② Rear fog light
- ③ Back-up light

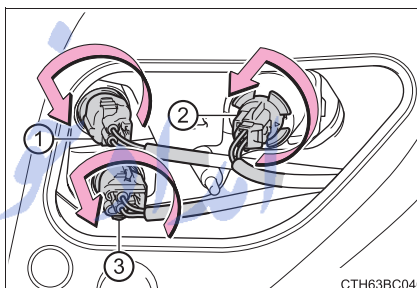

- 3 Remove the light bulb.

- ① Tail light
- ② Rear fog light
- ③ Back-up light

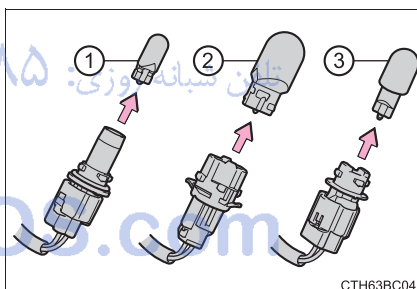

- 4 When installing, reverse the steps listed.

**■ License plate light**

- 1 Remove the lens.

Insert a properly sized screwdriver into the hole of the lens, and pry off the lens as shown in the illustration.

To prevent damaging the vehicle, wrap the screwdriver with a tape.

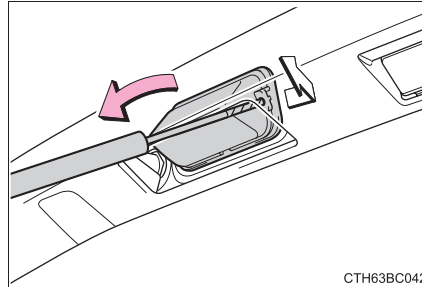

- 2 Remove the light bulb.

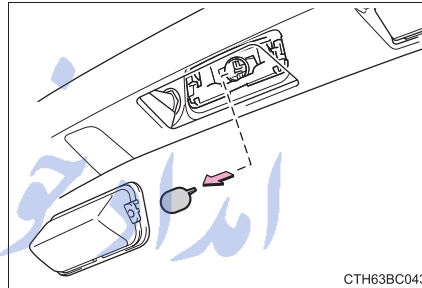

- 3 When installing, reverse the steps listed.

تلفن شبانه روزی: ۰۲۱-۸۸۸۶۲۰۸۵

FarmaSOS.com

■ Side turn signal light

- 1 Remove the cover.

Insert the flathead screwdriver and slide along the side turn signal light.

To prevent damaging the vehicle, wrap the flathead screwdriver with a tape.

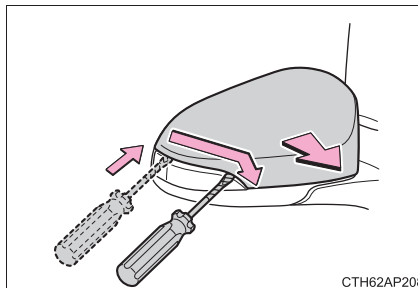

- 2 Press on the 2 clips and remove the side turn signal light from the visor housing.

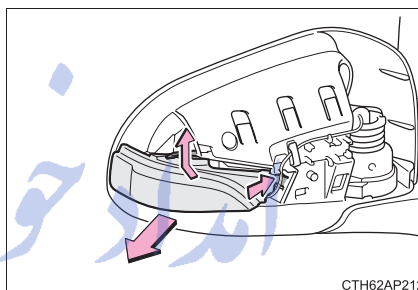

- 3 Remove the socket from the side turn signal light housing.

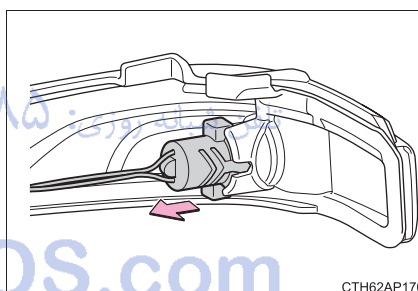

- 4 Remove the bulb.

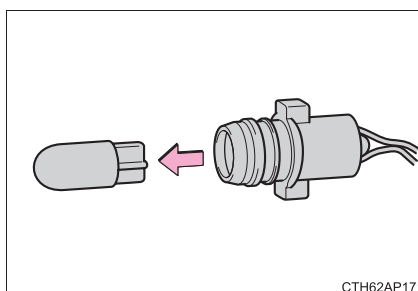

- 5 Replace the bulb and install the socket to the side turn signal light housing.

Align the grooves of the socket to the side turn signal light housing.

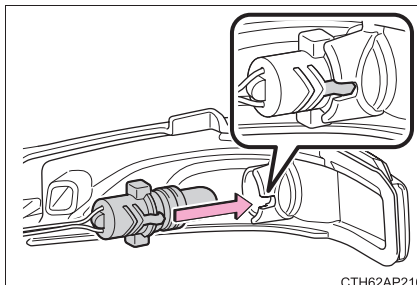

- 6 With the wire harness passing through the lower part of the side turn signal light, install it to the visor housing.

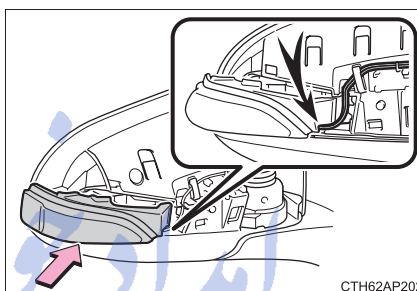

- 7 Align the 6 tabs and install the cover.

After hearing a click sound, confirm that the cover is secure.

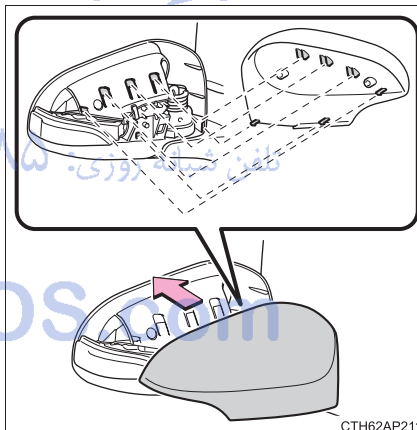

### ■ Replacing the following bulbs

If any of the lights listed below has burnt out, have it replaced by any authorized Toyota dealer or repairer, or another duly qualified and equipped professional.

- Headlights (vehicles with LED headlights)
- Front position lights/daytime running lights
- High mounted stoplight
- Stop/tail light (LED type)
- Tail lights (LED type)
- Rear fog light (LED type)

### ■ LED light bulbs

The headlights (vehicles with LED headlights), rear fog light (LED type), high mounted stoplight, front position lights/daytime running lights, Stop/tail light (LED type) and tail lights (LED type) consist of a number of LEDs. If any of the LEDs burn out, take your vehicle to any authorized Toyota dealer or repairer, or another duly qualified and equipped professional to have the light replaced.

### ■ Condensation build-up on the inside of the lens

Temporary condensation build-up on the inside of the headlight lens does not indicate a malfunction.

Contact any authorized Toyota dealer or repairer, or another duly qualified and equipped professional for more information in the following situations:

- Large drops of water have built up on the inside of the lens.
- Water has built up inside the headlight.

### ⚠ WARNING

#### ■ Replacing light bulbs

- Turn off the lights. Do not attempt to replace the bulb immediately after turning off the lights.  
The bulbs become very hot and may cause burns.
- Do not touch the glass portion of the light bulb with bare hands. When it is unavoidable to hold the glass portion, use and hold with a clean dry cloth to avoid getting moisture and oils on the bulb.  
Also, if the bulb is scratched or dropped, it may blow out or crack.
- Fully install light bulbs and any parts used to secure them. Failure to do so may result in heat damage, fire, or water entering the headlight unit. This may damage the headlights or cause condensation to build up on the lens.

#### ■ To prevent damage or fire

Make sure bulbs are fully seated and locked.



## When trouble arises

## 8

**8-1. Essential information**

Emergency flashers.....	502
If your vehicle has to be stopped in an emergency.....	503

**8-2. Steps to take in an emergency**

If your vehicle needs to be towed.....	505
If you think something is wrong.....	511
Fuel pump shut off system.....	512
If a warning light turns on or a warning buzzer sounds.....	513
If a warning message is displayed.....	526
If you have a flat tire (vehicles with an emergency tire puncture repair kit).....	532

If you have a flat tire (vehicles with a spare tire).....	555
If the engine will not start.....	571
If the shift lever cannot be shifted from P.....	573
If the shift lever cannot be shifted.....	574
If the electronic key does not operate properly.....	575
If the vehicle battery is discharged.....	578
If your vehicle overheats.....	584
If you run out of fuel and the engine stalls.....	587
If the vehicle becomes stuck.....	588

FarmaSOS.com

## Emergency flashers

The emergency flashers are used to warn other drivers when the vehicle has to be stopped in the road due to a breakdown, etc.

Press the switch.

All the turn signal lights will flash.  
To turn them off, press the switch  
once again.

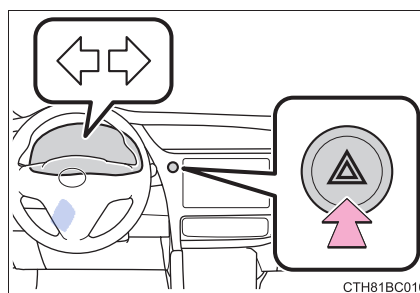

### ■ Emergency flashers

If the emergency flashers are used for a long time while the engine is not operating, the battery may discharge.

تلفن شبانه روزی: ۰۲۱-۸۸۶۲۰۸۵

FarmaSOS.com

## If your vehicle has to be stopped in an emergency

**Only in an emergency, such as if it becomes impossible to stop the vehicle in the normal way, stop the vehicle using the following procedure:**

- 1 Steadily step on the brake pedal with both feet and firmly depress it.  
Do not pump the brake pedal repeatedly as this will increase the effort required to slow the vehicle.
- 2 Shift the shift lever to N.
  - ▶ If the shift lever is shifted to N
- 3 After slowing down, stop the vehicle in a safe place by the road.
- 4 Stop the engine.
  - ▶ If the shift lever cannot be shifted to N
- 3 Keep depressing the brake pedal with both feet to reduce vehicle speed as much as possible.
- 4 Vehicles without a smart entry & start system: Stop the engine by turning the engine switch to the "ACC" position.

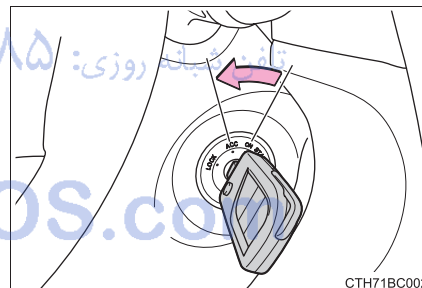

- 4 Vehicles with a smart entry & start system: To stop the engine, press and hold the engine switch for 2 consecutive seconds or more, or press it briefly 3 times or more in succession.

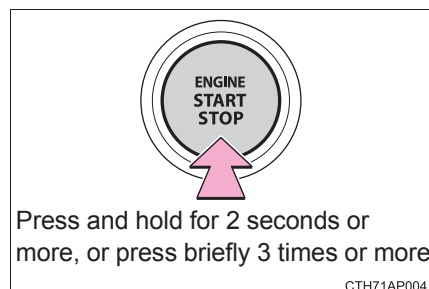

- 5 Stop the vehicle in a safe place by the road.

 WARNING**■ If the engine has to be turned off while driving**

- Power assist for the brakes and steering wheel will be lost, making the brake pedal harder to depress and the steering wheel heavier to turn. Decelerate as much as possible before turning off the engine.
- Vehicles without a smart entry & start system: Never attempt to remove the key, as doing so will lock the steering wheel.

امداد خودرو فارما

تلفن شبانه روزی: ۰۲۱-۸۸۸۶۲۰۸۵

FarmaSOS.com

## If your vehicle needs to be towed

If towing is necessary, we recommend having your vehicle towed by any authorized Toyota dealer or repairer, or another duly qualified and equipped professional or commercial towing service, using a wheel-lift type truck or flatbed truck. Use a safety chain system for all towing, and abide by all state/provincial and local laws.

### Situations when it is necessary to contact dealers before towing

The following may indicate a problem with your transmission. Contact any authorized Toyota dealer or repairer, or another duly qualified and equipped professional or commercial towing service before towing.

- The engine is running but the vehicle does not move.
- The vehicle makes an abnormal sound.

### Towing with a sling-type truck

Do not tow with a sling-type truck to prevent body damage.



### Towing with a wheel-lift type truck

► From the front

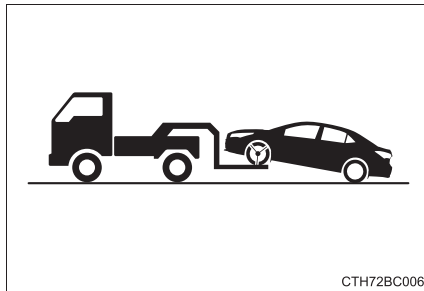

Release the parking brake.

► From the rear

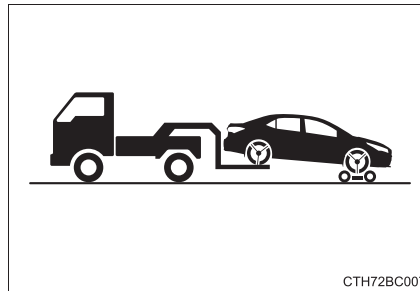

Use a towing dolly under the front wheels.

### Using a flatbed truck

If your vehicle is transported by a flatbed truck, it should be tied down at the locations shown in the illustration.

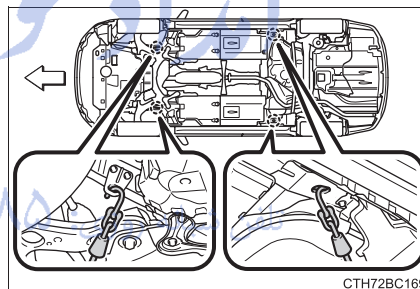

If you use chains or cables to tie down your vehicle, the angles shaded in black must be 45°.

Do not overly tighten the tie downs or the vehicle may be damaged.

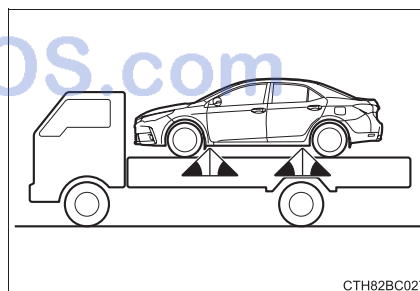

### Emergency towing

If a tow truck is not available in an emergency, your vehicle may be temporarily towed using cables or chains secured to the emergency towing eyelets. This should only be attempted on hard surfaced roads for at most 80 km (50 miles) at under 30 km/h (18 mph).

A driver must be in the vehicle to steer and operate the brakes. The vehicle's wheels, drive train, axles, steering and brakes must be in good condition.

### Emergency towing procedure

1 Take out the towing eyelet. (→P. 534, 556)

2 Remove the eyelet cover using a flathead screwdriver.

To prevent damage, cover the tip of the screwdriver with a rag.

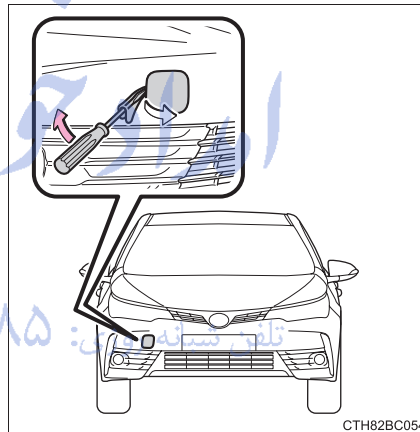

3 Insert the towing eyelet into the hole and tighten partially by hand.

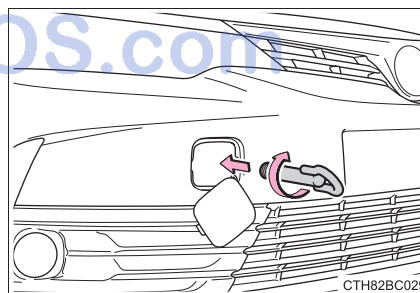

**508** 8-2. Steps to take in an emergency

- 4 Tighten down the towing eyelet securely using a wheel nut wrench or hard metal bar.

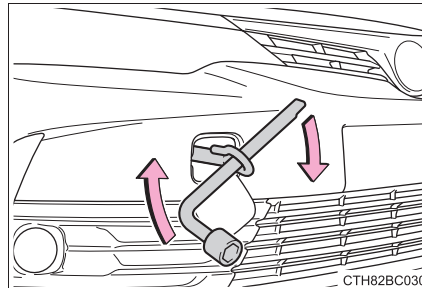

- 5 Securely attach cables or chains to the towing eyelet.  
Take care not to damage the vehicle body.
- 6 Vehicles without a smart entry & start system: Enter the vehicle being towed and start the engine.  
If the engine does not start, turn the engine switch to the "ON" position.  
Vehicles with a smart entry & start system: Enter the vehicle being towed and start the engine.  
If the engine does not start, turn the engine switch to IGNITION ON mode.
- 7 Shift the shift lever to N and release the parking brake.  
When the shift lever cannot be shifted (vehicles without a manual transmission): →P. 573, 574

■ **While towing**

If the engine is not running, the power assist for the brakes and steering will not function, making steering and braking more difficult.

■ **Wheel nut wrench**

- Vehicles without a wheel nut wrench: Wheel nut wrench can be purchased at any authorized Toyota dealer or repairer, or another duly qualified and equipped professional.
- Vehicles with a wheel nut wrench: Wheel nut wrench is installed in the trunk. (→P. 534, 556)



**⚠ WARNING**

Observe the following precautions.  
Failure to do so may result in death or serious injury.

■ **When towing the vehicle**

Be sure to transport the vehicle with the front wheels raised or with all four wheels raised off the ground.

If the vehicle is towed with the front wheels contacting the ground, the drivetrain and related parts may be damaged.

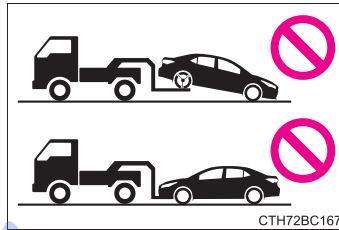

■ **While towing**

- When towing using cables or chains, avoid sudden starts, etc. which place excessive stress on the towing eyelets, cables or chains. The towing eyelets, cables or chains may become damaged, broken debris may hit people, and cause serious damage.
- Vehicles without a smart entry & start system: Do not turn the engine switch to the "LOCK" position.  
There is a possibility that the steering wheel is locked and cannot be operated.
- Vehicles with a smart entry & start system: Do not turn the engine switch off.  
There is a possibility that the steering wheel is locked and cannot be operated.

■ **Installing towing eyelet to the vehicle**

Make sure that towing eyelet is installed securely.  
If not securely installed, towing eyelet may come loose during towing.

 NOTICE

■ **To prevent causing serious damage to the Stop & Start system when towing (vehicles with a Stop & Start system)**

Never tow this vehicle with four wheels on the ground. Use a flatbed truck, or lift up front or rear of the vehicle by using a wheel-lift type truck.

■ **To prevent damage to the vehicle when towing using a wheel-lift type truck**

● Vehicles without a smart entry & start system: Do not tow the vehicle from the rear when the engine switch is in the "LOCK" position or the key is removed.

The steering lock mechanism is not strong enough to hold the front wheels straight.

● Vehicles with a smart entry & start system: Do not tow the vehicle from the rear when the engine switch is off. The steering lock mechanism is not strong enough to hold the front wheels straight.

● When raising the vehicle, ensure adequate ground clearance for towing at the opposite end of the raised vehicle. Without adequate clearance, the vehicle could be damaged while being towed.

■ **To prevent damage to the vehicle when towing with a sling-type truck**

Do not tow with a sling-type truck, either from the front or rear.

■ **To prevent damage to the vehicle during emergency towing**

Do not secure cables or chains to the suspension components.

FarmaSOS.com

## If you think something is wrong

If you notice any of the following symptoms, your vehicle probably needs adjustment or repair. Contact any authorized Toyota dealer or repairer, or another duly qualified and equipped professional as soon as possible.

### Visible symptoms

- Fluid leaks under the vehicle.  
(Water dripping from the air conditioning after use is normal.)
- Flat-looking tires or uneven tire wear
- Vehicles with a drive monitor display: High engine coolant temperature warning light comes on.
- Vehicles with a multi-information display: engine coolant temperature gauge needle continually points higher than normal.

### Audible symptoms

- Changes in exhaust sound
- Excessive tire squeal when cornering
- Strange noises related to the suspension system
- Pinging or other noises related to the engine

### Operational symptoms

- Engine missing, stumbling or running roughly
- Appreciable loss of power
- Vehicle pulls heavily to one side when braking
- Vehicle pulls heavily to one side when driving on a level road
- Loss of brake effectiveness, spongy feeling, pedal almost touches the floor

## Fuel pump shut off system (gasoline engine)

To minimize the risk of fuel leakage when the engine stalls or when an airbag inflates upon collision, the fuel pump shut off system stops the supply of fuel to the engine.

Follow the procedure below to restart the engine after the system is activated.

▶ Vehicles without a smart entry & start system

- 1 Turn the engine switch to the "ACC" or "LOCK" position.
- 2 Restart the engine.

▶ Vehicles with a smart entry & start system

- 1 Turn the engine switch to ACCESSORY mode or turn it off.
- 2 Restart the engine.

### NOTICE

#### ■ Before starting the engine





Inspect the ground under the vehicle. تلفن شبانه روزی: ۰۲۱-۸۸۴۲۰۸۵  
If you find that fuel has leaked onto the ground, the fuel system has been damaged and is in need of repair. Do not restart the engine.





FarmaSOS.com





## If a warning light turns on or a warning buzzer sounds





Calmly perform the following actions if any of the warning lights comes on or flashes. If a light comes on or flashes, but then goes off, this does not necessarily indicate a malfunction in the system. However, if this continues to occur, have the vehicle inspected by any authorized Toyota dealer or repairer, or another duly qualified and equipped professional.

### Warning light and warning buzzer list









Warning light	Warning light/Details/Actions
	<p><b>Brake system warning light (warning buzzer)*1</b> Indicates that:</p> <ul style="list-style-type: none"> <li>• The brake fluid level is low; or</li> <li>• The brake system is malfunctioning</li> </ul> <p>This light also comes on when the parking brake is not released. If the light turns off after the parking brake is fully released the system is operating normally.</p> <p>→ <b>Immediately stop the vehicle in a safe place and contact any authorized Toyota dealer or repairer, or another duly qualified and equipped professional. Continuing to drive the vehicle may be dangerous.</b></p>
 (If equipped)	<p><b>Charging system warning light</b> Indicates a malfunction in the vehicle's charging system</p> <p>→ <b>Immediately stop the vehicle in a safe place and contact any authorized Toyota dealer or repairer, or another duly qualified and equipped professional.</b></p>
 (If equipped)	<p><b>Low engine oil pressure warning light</b> Indicates that the engine oil pressure is too low.</p> <p>→ <b>Immediately stop the vehicle in a safe place and contact any authorized Toyota dealer or repairer, or another duly qualified and equipped professional.</b></p>
 (If equipped)	<p><b>High engine coolant temperature warning light</b> Indicates that the engine is almost overheating. (→P. 584)</p> <p>→ <b>Immediately stop the vehicle in a safe place and contact any authorized Toyota dealer or repairer, or another duly qualified and equipped professional.</b></p>



Warning light	Warning light/Details/Actions
 (Comes on)	<p><b>Multi-mode manual transmission warning light*<sup>3</sup></b>            Indicates a malfunction in the multi-mode manual transmission system.            → <b>Have the system checked by any authorized Toyota dealer or repairer, or another duly qualified and equipped professional.</b></p> <p><b>Multi-mode manual transmission warning light (warning buzzer)*<sup>3</sup></b>            Indicates a malfunction in the multi-mode manual transmission system and that the clutch has become hot due to excessive load.            → <b>Pull over and shift the shift lever to N. Wait for about 15 minutes for the clutch to cool down. Have the system checked by any authorized Toyota dealer or repairer, or another duly qualified and equipped professional.</b></p>
 (Flashes)	<p><b>Heat clutch warning light (warning buzzer)*<sup>3</sup></b>            Indicates that the clutch has become hot, but does not indicate a malfunction in the multi-mode manual transmission system.            → <b>Pull over and shift the shift lever to N. Wait for about 15 minutes for the clutch to cool down.</b></p>
	<p><b>Malfunction indicator lamp</b> <span style="color: blue;">تلفن شبانه روزی: ۰۲۱۸۸۸۴۲۰۸</span>            Indicates a malfunction in:</p> <ul style="list-style-type: none"> <li>• The electronic engine control system;</li> <li>• The electronic throttle control system;</li> <li>• The electronic Multidrive control system;</li> <li>• The electronic multi-mode manual transmission control system; or</li> <li>• The DPF catalytic converter</li> </ul> <p>→ <b>Have the vehicle inspected by any authorized Toyota dealer or repairer, or another duly qualified and equipped professional immediately.</b></p>
	<p><b>SRS warning light</b>            Indicates a malfunction in:</p> <ul style="list-style-type: none"> <li>• The SRS airbag system; or</li> <li>• The seat belt pretensioner system</li> </ul> <p>→ <b>Have the vehicle inspected by any authorized Toyota dealer or repairer, or another duly qualified and equipped professional immediately.</b></p>

Warning light	Warning light/Details/Actions
	<p><b>ABS warning light</b> Indicates a malfunction in:</p> <ul style="list-style-type: none"> <li>• The ABS; or</li> <li>• The brake assist system</li> </ul> <p>→ <b>Have the vehicle inspected by any authorized Toyota dealer or repairer, or another duly qualified and equipped professional immediately.</b></p>
	<p><b>Electric power steering system warning light (warning buzzer)</b> Indicates a malfunction in the EPS (Electric Power Steering) system.</p> <p>→ <b>Have the vehicle inspected by any authorized Toyota dealer or repairer, or another duly qualified and equipped professional immediately.</b></p>
 <p>(Comes on)</p>	<p><b>Slip indicator</b> Indicates a malfunction in:</p> <ul style="list-style-type: none"> <li>• The VSC system;</li> <li>• The TRC system; or</li> <li>• The hill-start assist control system</li> </ul> <p>The light will flash when the VSC, the TRC or the hill-start assist control system (vehicles with a diesel engine for Turkey) is operating.</p> <p>→ <b>Have the vehicle inspected by any authorized Toyota dealer or repairer, or another duly qualified and equipped professional immediately.</b></p>
 <p>(If equipped)</p>	<p><b>Automatic headlight leveling system warning light</b> Indicates a malfunction in the automatic headlight leveling system</p> <p>→ <b>Have the vehicle inspected by any authorized Toyota dealer or repairer, or another duly qualified and equipped professional immediately.</b></p>
 <p>(If equipped)</p>	<p><b>LED headlight warning light (warning buzzer)</b> Indicates a malfunction in the LED headlights</p> <p>→ <b>Have the vehicle inspected by any authorized Toyota dealer or repairer, or another duly qualified and equipped professional immediately.</b></p>

Warning light	Warning light/Details/Actions
 <p>(If equipped)</p>	<p><b>PCS warning light</b></p> <p>When the warning light flashes (and a buzzer sounds): Indicates a malfunction in the PCS (Pre-Crash Safety system)</p> <p>→ <b>Have the vehicle inspected by any authorized Toyota dealer or repairer, or another duly qualified and equipped professional immediately.</b></p> <p>When the warning light flashes (and a buzzer does not sound): Indicates that the PCS (Pre-Crash Safety system) is temporarily unavailable, possibly due to either of the following:</p> <ul style="list-style-type: none"> <li>• The part of the windshield around the front sensor being dirty, fogged up or covered with condensation, ice, stickers, etc.</li> </ul> <p>→ <b>Clear the dirt, fog, condensation, ice, stickers, etc. (→P. 243)</b></p> <ul style="list-style-type: none"> <li>• Front sensor temperature being outside of its operational range</li> </ul> <p>→ <b>Wait for a while until the area around the front sensor has cooled down sufficiently.</b></p> <p>When the warning light is illuminated: Either the VSC (Vehicle Stability Control) system or PCS (Pre-Crash Safety system) is disabled or both are disabled.</p> <p>→ <b>To enable the PCS, enable both the VSC system and PCS. (→P. 249, 316)</b></p>
 <p>(Flashes) (If equipped)</p>	<p><b>Stop &amp; Start cancel indicator</b></p> <p>Indicates a malfunction in the Stop &amp; Start system (The Stop &amp; Start cancel indicator will come on when the system is canceled.: →P. 275)</p> <p>→ <b>Have the vehicle inspected by any authorized Toyota dealer or repairer, or another duly qualified and equipped professional immediately.</b></p>
 <p>(If equipped)</p>	<p><b>Fuel filter warning light</b></p> <p>Indicate that the amount of accumulated water in the fuel filter has reached the specified level.</p> <p>→ <b>Have the vehicle inspected by any authorized Toyota dealer or repairer, or another duly qualified and equipped professional immediately.</b></p>
 <p>(Comes on in yellow) (If equipped)</p>	<p><b>Cruise control indicator light</b></p> <p>Indicates a malfunction in the cruise control system.</p> <p>→ <b>Have the vehicle inspected by any authorized Toyota dealer or repairer, or another duly qualified and equipped professional immediately.</b></p>



Warning light	Warning light/Details/Actions
 (Comes on in yellow) (If equipped)	<b>Speed limiter indicator</b> Indicates a malfunction in the speed limiter. → <b>Have the vehicle inspected by any authorized Toyota dealer or repairer, or another duly qualified and equipped professional immediately.</b>
 (Flashes in yellow for 15 seconds) (If equipped)	<b>Smart entry &amp; start system indicator light</b> Indicates a malfunction in the smart entry & start system. → <b>Have the vehicle inspected by any authorized Toyota dealer or repairer, or another duly qualified and equipped professional immediately.</b>
 (If equipped)	<b>Open door warning light (warning buzzer)*2</b> Indicates that a door or the trunk is not fully closed. → <b>Check that all the doors and the trunk are closed.</b>
 (If equipped)	<b>Low fuel level warning light</b> Indicates remaining fuel is approximately 8.2 L (2.2 gal., 1.8 Imp. gal.) or less. → <b>Refuel the vehicle.</b>
 (If equipped)	<b>Driver's and front passenger's seat belt reminder light (warning buzzer)*4</b> Warns the driver and/or front passenger to fasten their seat belts. → <b>Fasten the seat belt.</b>
 (If equipped)	<b>Rear passengers' seat belt reminder lights (warning buzzer)*4</b> Warns the rear passengers to fasten their seat belts. → <b>Fasten the seat belt.</b>
 (If equipped)	<b>Low engine oil level warning light</b> Indicates that engine oil level is low, but does not indicate a malfunction. → <b>Park the vehicle on a level surface, check the engine oil level and add engine oil if necessary. (→P. 447)</b>
 (If equipped)	<b>Low windshield washer fluid warning light</b> Low level of washer fluid. → <b>Fill the tank.</b>





Warning light	Warning light/Details/Actions
 <p>(If equipped)</p>	<p><b>DPF system warning light</b></p> <ul style="list-style-type: none"> <li>Indicates that the DPF catalytic converter needs to be cleaned due to repeated short trips and/or low-speed driving.</li> <li>Indicates that the amount of accumulated deposits in the DPF catalytic converter has reached the specified level.</li> </ul> <p>→ <b>To clean with DPF catalytic converter, drive the vehicle at a speed of 65 km/h (40 mph) or greater for 20 to 30 minutes as much as possible until the DPF system warning light turns off*5.</b></p> <p><b>Do not turn off the engine as much as possible until the DPF system warning light turns off.</b></p> <p><b>If it is not possible to drive the vehicle at speeds of 65 km/h (40 mph) or greater, or the DPF system warning light does not turn off even after driving for more than 30 minutes, have the vehicle inspected by any authorized Toyota dealer or repairer, or another duly qualified and equipped professional.</b></p>
 <p>(If equipped)</p>	<p><b>Engine oil change reminder light</b></p> <p>When the light flashes: Indicates that the engine oil is scheduled to be changed. (The indicator will not work properly unless the oil maintenance date has been reset).</p> <p>→ <b>Check the engine oil, and change if necessary. After changing the engine oil, the oil change system should be reset. (→P. 450)</b></p> <p>When the light comes on: Indicates that the engine oil should be changed. After the engine oil is changed and the oil maintenance data has been reset.</p> <p>→ <b>Check and change the engine oil, and oil filter by any authorized Toyota dealer or repairer, or another duly qualified and equipped professional. After changing the engine oil, the oil change system should be reset. (→P. 450)</b></p>
 <p>(If equipped)</p>	<p><b>Master warning light</b></p> <p>A buzzer sounds and the warning light comes on and flashes to indicate that the master warning system has detected a malfunction.</p> <p>→ <b>P. 526</b></p>





Warning light	Warning light/Details/Actions
	<p><b>Tire pressure warning light</b>            When the light comes on:            Low tire inflation pressure such as</p> <ul style="list-style-type: none"> <li>• Natural causes (→P. 522)</li> <li>• Flat tire (→P. 532, 555)</li> </ul> <p>→ <b>Adjust the tire inflation pressure to the specified level.</b>  <b>The light will turn off after a few minutes. In case the light does not turn off even if the tire inflation pressure is adjusted, have the system checked by any authorized Toyota dealer or repairer, or another duly qualified and equipped professional.</b></p> <p>When the light comes on after blinking for 1 minute:            Malfunction in the tire pressure warning system (→P. 523)            → <b>Have the system checked by any authorized Toyota dealer or repairer, or another duly qualified and equipped professional.</b></p>

- \*1: Parking brake engaged warning buzzer:  
 The buzzer sounds to indicate that the parking brake is still engaged (with the vehicle having reached a speed of 5 km/h [3 mph]).
- \*2: Open door warning buzzer:  
 The open door warning buzzer sounds to alert one or more of the doors is not fully closed (with the vehicle having reached a speed of 5 km/h [3 mph]).
- \*3: Vehicles with a multi-mode manual transmission
- \*4: Driver's and passengers' seat belt buzzer:  
 The driver's and passengers' seat belt buzzer sounds to alert the driver and passengers that his or her seat belt is not fastened. The buzzer sounds for 30 seconds after the vehicle reaches a speed of at least 20 km/h (12 mph). Then, if the seat belt is still unfastened, the buzzer will sound in a different tone for 90 more seconds.
- \*5: The DPF system warning light may not turn off when the engine oil change reminder light is on. In this event, have the vehicle inspected by any authorized Toyota dealer or repairer, or another duly qualified and equipped professional.

**Follow the correction procedures. (vehicles with a smart entry & start system and with a drive monitor display)**

After taking the specified steps to correct the suspected problem, check that the warning light turns off.

Interior buzzer	Exterior buzzer	Warning light	Warning light/Details/Action
Continuous	Continuous	 (Flashes in yellow)	<p><b>Smart entry &amp; start system indicator light (vehicles with a Multidrive)</b> The electronic key was carried outside the vehicle and the driver's door was opened and closed while any shift position other than P was selected without turning off the engine switch. → <b>Change the shift position to P.</b> → <b>Bring the electronic key back into the vehicle.</b></p>
Once	3 times	 (Flashes in yellow)	<p><b>Smart entry &amp; start system indicator light (vehicles with a Multidrive)</b> The electronic key was carried outside the vehicle and the driver's door was opened and closed while the shift position P was selected without turning off the engine switch. → <b>Turn the engine switch off or bring the electronic key back into the vehicle.</b></p> <p><b>Smart entry &amp; start system indicator light</b> Indicates that a door other than the driver's door has been opened and closed with the engine switch in any mode other than OFF and the electronic key outside of the detection area. → <b>Confirm the location of the electronic key.</b></p>
Once	Continuous (5 seconds)	 (Flashes in yellow)	<p><b>Smart entry &amp; start system indicator light</b> An attempt was made to exit the vehicle with the electronic key and lock the doors without first turning the engine switch off. → <b>Turn the engine switch off and lock the doors again.</b></p>
Once	—	 (Flashes in yellow for 15 seconds)	<p><b>Smart entry &amp; start system indicator light</b> Indicates that the electronic key is not present when attempting to start the engine. → <b>Confirm the location of the electronic key.</b></p>

Interior buzzer	Exterior buzzer	Warning light	Warning light/Details/Action
9 times	—	 (Flashes in yellow)	<b>Smart entry &amp; start system indicator light</b> An attempt was made to drive when the regular key was not inside the vehicle. → <b>Confirm that the electronic key is inside the vehicle.</b>
Once	—	 (Flashes in yellow for 15 seconds)	<b>Smart entry &amp; start system indicator light</b> Indicates that the electronic key battery is low. → <b>Replace the battery. (→P. 480)</b>
Once	—	 (Flashes quickly in green for 15 seconds)	<b>Smart entry &amp; start system indicator light</b> Indicates that the steering lock has not been released. → <b>Release the steering lock. (→P. 205)</b>
Once	—	 (Flashes in yellow for 30 seconds)	<b>Smart entry &amp; start system indicator light</b> <ul style="list-style-type: none"> <li>• When the doors were unlocked with the mechanical key and then the engine switch was pressed, the electronic key could not be detected in the vehicle.</li> <li>• The electronic key could not be detected in the vehicle even after the engine switch was pressed two consecutive times.</li> </ul> → <b>Vehicles without a manual transmission:</b> <b>Touch the electronic key to the engine switch while depressing the brake pedal.</b> → <b>Vehicles with a manual transmission:</b> <b>Touch the electronic key to the engine switch while depressing the clutch pedal.</b>

■ **Front passenger detection sensor, seat belt reminder and warning buzzer**

- If luggage is placed on the front passenger seat, the front passenger detection sensor may cause the warning light to flash and the warning buzzer to sound even if a passenger is not sitting in the seat.
- If a cushion is placed on the seat, the sensor may not detect a passenger, and the warning light may not operate properly.

■ **If the malfunction indicator lamp comes on while driving**

The malfunction indicator lamp will come on if the fuel tank becomes completely empty. If the fuel tank is empty, refuel the vehicle immediately. The malfunction indicator lamp will go off after several trips.

If the malfunction indicator lamp does not go off, contact any authorized Toyota dealer or repairer, or another duly qualified and equipped professional as soon as possible.

■ **To prevent the clutch from overheating**

Observe the following while driving.

- Do not keep driving up a hill at low speeds.
- Do not start off and stop repeatedly on an uphill.
- Do not use the accelerator pedal or starting assist system to hold the vehicle on a hill.

■ **When the tire pressure warning light comes on**

Check the tire inflation pressure and adjust to the appropriate level. Pushing the tire pressure warning reset switch will not turn off the tire pressure warning light.

■ **The tire pressure warning light may come on due to natural causes**

The tire pressure warning light may come on due to natural causes such as natural air leaks and tire inflation pressure changes caused by temperature. In this case, adjusting the tire inflation pressure will turn off the warning light (after a few minutes).

■ **When a tire is replaced with a spare tire**

The spare tire is not equipped with a tire pressure warning valve and transmitter. If a tire goes flat, the tire pressure warning light will not turn off even though the flat tire has been replaced with the spare tire. Replace the spare tire with the repaired tire and adjust the tire inflation pressure. The tire pressure warning light will go off after a few minutes.

**■ Conditions that the tire pressure warning system may not function properly**

→P. 464

**■ If the tire pressure warning light frequently comes on after blinking for 1 minute**

If the tire pressure warning light frequently comes on after blinking for 1 minute when the engine switch is turned on, have it checked by any authorized Toyota dealer or repairer, or another duly qualified and equipped professional.

**■ Warning buzzer**

In some cases, the buzzer may not be heard because of noisy place or an audio sound.

**■ If the engine oil change reminder light flashes (if equipped)**

Repeated short trips and/or low-speed driving may cause the oil to degrade sooner than usual, regardless of the actual distance driven. If this happens, the engine oil change reminder light will flash.

**■ Engine oil change reminder light comes on (if equipped)**

Replace the engine oil filter when the engine oil change reminder light does not come on even if you have driven over 15000 km (9300 miles) after the engine oil was changed.

There is a possibility that the engine oil change reminder light has been illuminated when you have driven less than 15000 km (9300 miles) based on a usage or driving condition.

**■ Electric power steering system warning light (warning buzzer)**

When the battery charge becomes insufficient or the voltage temporarily drops, the electric power steering system warning light may come on and the warning buzzer may sound.

FarmaSOS.com

 **WARNING****■ If both the ABS and the brake system warning lights remain on**

Stop your vehicle in a safe place immediately and contact any authorized Toyota dealer or repairer, or another duly qualified and equipped professional. The vehicle will become extremely unstable during braking, and the ABS system may fail, which could cause an accident resulting in death or serious injury.

**■ When the electric power steering system warning light comes on**

The steering wheel may become extremely heavy. When steering wheel operations are heavier than usual, grip the steering wheel firmly and operate it using more force than usual.

**■ When driving to clean the DPF catalytic converter (if equipped)**

When driving, pay sufficient attention to weather, road conditions, terrain and traffic conditions, and be sure to observe traffic laws and/or regulations. Failure to do so may cause an unexpected accident, resulting in death or serious injury.

**■ If the tire pressure warning light comes on**

Be sure to observe the following precautions. Failure to do so could cause a loss of vehicle control and result in death or serious injury.

- Stop your vehicle in a safe place as soon as possible. Adjust the tire inflation pressure immediately.
- If the tire pressure warning light comes on even after tire inflation pressure adjustment, it is probable that you have a flat tire. Check the tires. If a tire is flat, change it with the spare tire and have the flat tire repaired by the nearest any authorized Toyota dealer or repairer, or another duly qualified and equipped professional.
- Avoid abrupt maneuvering and braking. If the vehicle tires deteriorate, you could lose control of the steering wheel or the brakes.

**■ If a blowout or sudden air leakage should occur**

The tire pressure warning system may not activate immediately.



 NOTICE

- **To ensure the tire pressure warning system operates properly**  
Do not install tires with different specifications or makers, as the tire pressure warning system may not operate properly.
- **When the DPF system warning light comes on (if equipped)**  
If the DPF system warning light is left on without performing cleaning, after an additional 100 to 300 km (62 to 187 miles), the malfunction indicator lamp may come on. If this happens, have the vehicle inspected by any authorized Toyota dealer or repairer, or another duly qualified and equipped professional immediately.
- **If the fuel filter warning light comes on (if equipped)**  
Never drive the vehicle with the warning light on. Continued driving with water accumulated in the fuel filter will damage the fuel injection pump.

امداد خودرو فارما

تلفن شبانه روزی: ۰۲۱-۸۸۸۶۲۰۸۵

FarmaSOS.com

## If a warning message is displayed (vehicles with a multi-information display)

The multi-information display shows warnings of system malfunctions, incorrectly performed operations, and messages that indicate a need for maintenance. When a message is shown, perform the correction procedure appropriate to the message.

① Master warning light

The master warning light also comes on or flashes in order to indicate that a message is currently being displayed on the multi-information display.\*

② Multi-information display

③ Handling method

Follow the instructions of the message on the multi-information display.

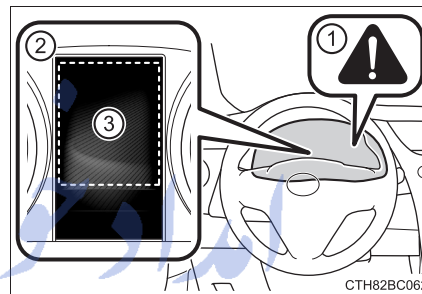

If any of the message or indicator comes on again after the following actions have been performed, contact any authorized Toyota dealer or repairer, or another duly qualified and equipped professional.

\*: The master warning light may not come on or flash when a warning message is displayed.

### Messages and warnings

The warning lights and warning buzzers operate as follows depending on the content of the message. If a message indicates the need for inspection by a dealer, have the vehicle inspected by any authorized Toyota dealer or repairer, or another duly qualified and equipped professional immediately.

	System warning light	Warning buzzer*	Warning
Comes on	—	Sounds	Indicates an important situation, such as when a system related to driving is malfunctioning or that danger may result if the correction procedure is not performed
—	Comes on or flashes	Sounds or does not sound	Indicates an important situation, such as when the systems shown on the multi-information display may be malfunctioning
Flashes	—	Sounds	Indicates a situation, such as when damage to the vehicle or danger may result
Comes on	—	Does not sound	Indicates a condition, such as malfunction of electrical components, their condition, or indicates the need for maintenance
—	—	Does not sound	Indicates a situation, such as when an operation has been performed incorrectly, or indicates how to perform an operation correctly

\*: A buzzer sounds the first time a message is shown on the multi-information display

#### If a message instructing to refer to the Owner's Manual is displayed

- If the following message is displayed, take the appropriate actions.
  - “DPF full. See owner’s manual.” (if equipped)  
→P. 530
- If the following message is displayed, there may be a malfunction. Immediately stop the vehicle in a safe place and contact any authorized Toyota dealer or repairer, or another duly qualified and equipped professional.
  - “Brake effectiveness is reduced due to failure, please stop in a safe area and check manual.”

**Other messages displayed on the multi-information display**

Take the appropriate actions as instructed in the message displayed. If any of the following messages are displayed, also refer to this Owner's Manual.

**■ If "Check charging system." is displayed**

Indicates a malfunction in the vehicle's charging system.

Immediately stop the vehicle in a safe place and contact any authorized Toyota dealer or repairer, or another duly qualified and equipped professional.

**■ If "Engine oil pressure low." is displayed**

Indicates that the engine oil pressure is too low.

Immediately stop the vehicle in a safe place and contact any authorized Toyota dealer or repairer, or another duly qualified and equipped professional.

**■ When "Headlight system malfunction. Visit your dealer." is displayed on the multi-information display (if equipped)**

The following systems may be malfunctioning. Have the vehicle inspected by any authorized Toyota dealer or repairer, or another duly qualified and equipped professional immediately.

- The LED headlight system
- The automatic headlight leveling system
- Automatic High Beam

**■ If "Front sensor systems are temporarily unavailable due to inappropriate temp. Wait a moment." or "Front Camera Vision Blocked Clean and Demist Windshield." is displayed (if equipped)**

The following systems may be suspended until the problem shown in the message is resolved.

- PCS (Pre-Crash Safety system)
- LDA (Lane Departure Alert)
- Automatic High Beam
- RSA (Road Sign Assist)

**■ If “Drain water from fuel filter.” is displayed (if equipped)**

Indicates that the amount of water that has accumulated in the fuel filter has reached a specified level.

→P. 458

**■ If “Engine oil low.” is displayed (if equipped)**

Indicates that the engine oil level may be low.

Park the vehicle on a level surface, check the engine oil level and add engine oil if necessary.

**■ If “Oil Maintenance required soon.” is displayed (if equipped)**

Indicates that the engine oil is scheduled to be changed. (The indicator will not work properly unless the oil maintenance data has been reset.)

Check the engine oil, and change if necessary. After changing the engine oil, the oil change system should be reset. (→P. 450)

**■ If “Oil maintenance required.” is displayed (if equipped)**

Indicates that the engine oil should be changed. (After the engine oil is changed and the oil maintenance data has been reset.)

Check and change the engine oil, and oil filter by any authorized Toyota dealer or repairer, or another duly qualified and equipped professional. After changing the engine oil, the oil change system should be reset. (→P. 450)

FarmaSOS.com

8

When trouble arises

■ **If “DPF full. See owner’s manual.” is displayed (if equipped)**

Indicates that the amount of accumulated deposits in the DPF catalytic converter has reached a specified level and it is necessary to clean the DPF catalytic converter. (Deposits may accumulate more quickly due to repeated short trips and/or frequent low-speed driving.)

To clean the DPF catalytic converter, drive the vehicle at a speed of 65 km/h (40 mph) or higher for 20 to 30 minutes until the message is cleared\*.

If possible, do not turn off the engine until the message is cleared. If it is not possible to drive the vehicle at a speed of 65 km/h (40 mph) or higher, or if the message is not cleared after driving for more than 30 minutes, have the vehicle inspected by any authorized Toyota dealer or repairer, or another duly qualified and equipped professional.

\*: This message may not be cleared if the engine oil change reminder is also displayed on the multi-information display. In this event, have the vehicle inspected by any authorized Toyota dealer or repairer, or another duly qualified and equipped professional.

■ **If “DPF full, engine service required.” is displayed (if equipped)**

Indicates that the automatic cleaning function may not be able to operate due to the amount of accumulated deposits in the DPF catalytic converter exceeding a specified level.

Have the vehicle inspected by any authorized Toyota dealer or repairer, or another duly qualified and equipped professional immediately.

### ■ System warning light

In the following situation, the master warning light will not come on or flash. Instead, a separate system warning light will come on along with a message displayed on the multi-information display.

Malfunction of the brake system

The brake system warning light will come on. (→P. 513)

### ■ Warning buzzer

In some cases, the buzzer may not be heard because of noisy place or an audio sound.

### ■ Engine oil change reminder message comes on (if equipped)

Replace the engine oil filter when the engine oil change reminder message does not come on even if you have driven over 15000 km (9300 miles) after the engine oil was changed.

There is a possibility that the “Oil maintenance required.” message has been displayed when you have driven less than 15000 km (9300 miles) based on a usage or driving condition.

### ▲ WARNING

#### ■ When driving to clean the DPF catalytic converter (if equipped)

When driving, pay sufficient attention to weather, road conditions, terrain and traffic conditions, and be sure to observe traffic laws and/or regulations. Failure to do so may cause an unexpected accident, resulting in death or serious injury.

### ▲ NOTICE

#### ■ When the DPF system warning message comes on (if equipped)

If the DPF system warning message is left on without performing cleaning, after an additional 100 to 300 km (62 to 187 miles), the malfunction indicator lamp may come on. If this happens, have the vehicle inspected by any authorized Toyota dealer or repairer, or another duly qualified and equipped professional immediately.

#### ■ If the fuel filter warning message comes on (if equipped)

Never drive the vehicle with the warning message is shown. Continued driving with water accumulated in the fuel filter will damage the fuel injection pump.

### **If you have a flat tire (vehicles with an emergency tire puncture repair kit)**

Your vehicle is not equipped with a spare tire, but instead is equipped with an emergency tire puncture repair kit.

A puncture caused by a nail or screw passing through the tire tread can be repaired temporarily using the emergency tire puncture repair kit. (The kit contains a bottle of sealant. The sealant can be used only once to temporarily repair one tire without removing the nail or screw from the tire.) Depending on the damage, this kit cannot be used to repair the tire. (→P. 533)

After temporarily repairing the tire with the kit, have the tire repaired or replaced by any authorized Toyota dealer or repairer, or another duly qualified and equipped professional. Repairs conducted using the emergency tire puncture repair kit are only a temporary measure. Have the tire repaired and replaced as soon as possible.

تلفن شبانه روزی: ۰۲۱-۸۸۸۶۲۰۸۵

FarmaSOS.com



### ■ Before repairing the tire

- Stop the vehicle in a safe place on a hard, flat surface.
- Set the parking brake.
- Shift the shift lever to P (vehicles with a Multidrive) or N (vehicles with a multi-mode manual transmission or manual transmission).
- Stop the engine.
- Turn on the emergency flashers. (→P. 502)
- Check the degree of the tire damage.
  - Do not remove the nail or screw from the tire. Removing the object may widen the opening and prevent emergency repair with the repair kit.
  - Type A: To avoid sealant leakage, move the vehicle until the area of the puncture, if known, is positioned at the top of the tire.

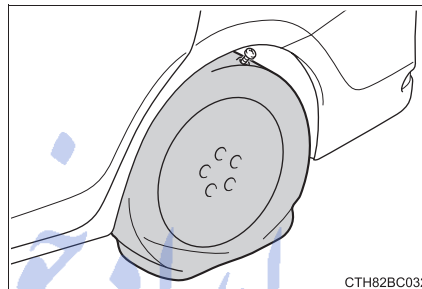

### ■ A flat tire that cannot be repaired with the emergency tire puncture repair kit

In the following cases, the tire cannot be repaired with the emergency tire puncture repair kit. Contact any authorized Toyota dealer or repairer, or another duly qualified and equipped professional.

- When the tire is damaged due to driving without sufficient air pressure
- When there are any cracks or damage at any location on the tire, such as on the side wall, except the tread
- When the tire is visibly separated from the wheel
- When the cut or damage to the tread is 4 mm (0.16 in.) long or more
- When the wheel is damaged
- When two or more tires have been punctured
- When 2 or more sharp objects such as nails or screws have passed through the tread on a single tire
- When the sealant has expired

■ Location of the emergency tire puncture repair kit

▶ Type A

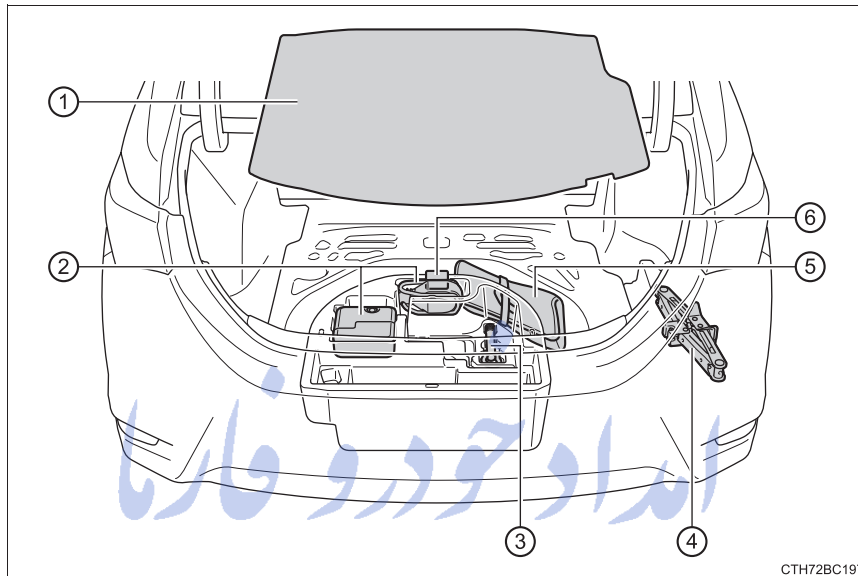

- ① Luggage floor cover
- ② Emergency tire puncture repair kit
- ③ Towing eyelet
- ④ Jack\*<sup>1</sup>
- ⑤ Tool bag
- ⑥ Wheel cap clip\*<sup>2</sup>

\*<sup>1</sup>: Use of the jack, jack handle and wheel nut wrench. (if equipped) (→P. 562)  
A jack, jack handle and wheel nut wrench can be purchased at any authorized Toyota dealer or repairer, or another duly qualified and equipped professional.

\*<sup>2</sup>: Use of the wheel cap clip. (if equipped) (→P. 476)

## ► Type B

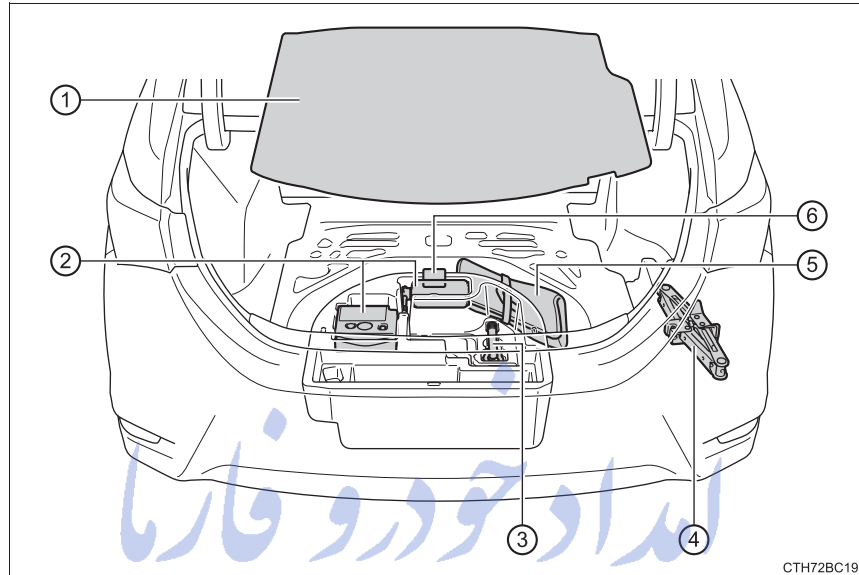

- |                                      |                                |
|--------------------------------------|--------------------------------|
| ① Luggage floor cover                | ④ Jack* <sup>1</sup>           |
| ② Emergency tire puncture repair kit | ⑤ Tool bag                     |
| ③ Towing eyelet                      | ⑥ Wheel cap clip* <sup>2</sup> |

\*1: Use of the jack, jack handle and wheel nut wrench. (if equipped) (→P. 562)  
A jack, jack handle and wheel nut wrench can be purchased at any authorized Toyota dealer or repairer, or another duly qualified and equipped professional.

\*2: Use of the wheel cap clip. (if equipped) (→P. 476)

■ Emergency tire puncture repair kit components

▶ Type A

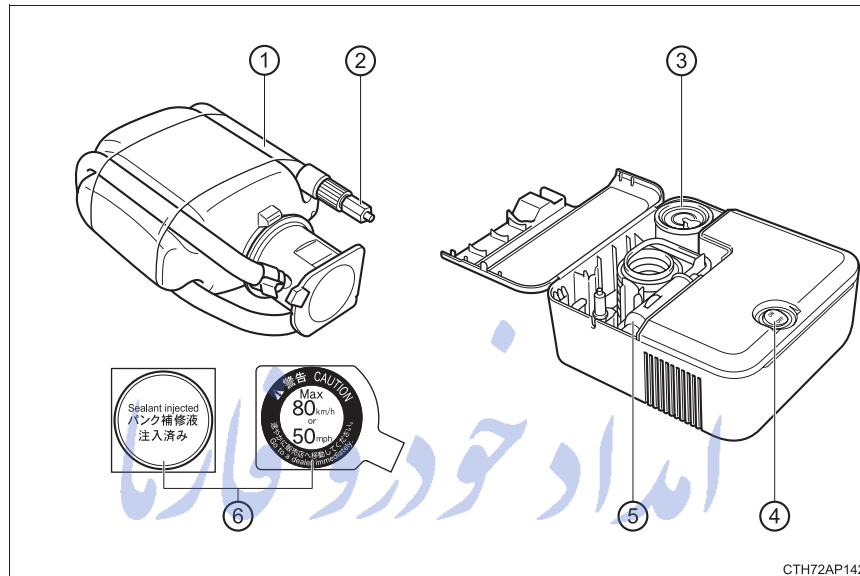

- ① Hose
- ② Air release cap
- ③ Air pressure gauge
- ④ Compressor switch
- ⑤ Power plug
- ⑥ Stickers

FarmaSOS.com

## ► Type B

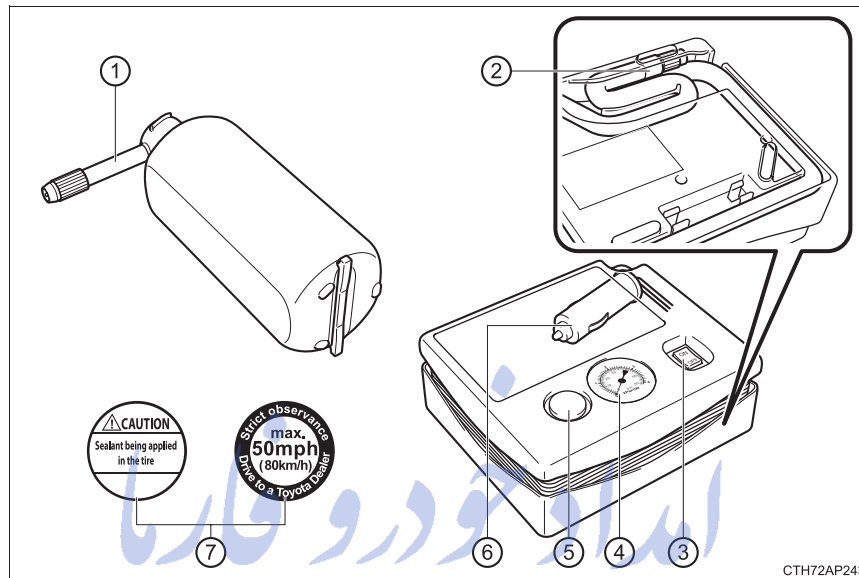

- |                      |                           |
|----------------------|---------------------------|
| ① Nozzle             | ⑤ Pressure release button |
| ② Hose               | ⑥ Power plug              |
| ③ Compressor switch  | ⑦ Stickers                |
| ④ Air pressure gauge |                           |

FarmaSOS.com

8

When trouble arises

### Taking out the emergency tire puncture repair kit

- 1 Remove the luggage floor cover.

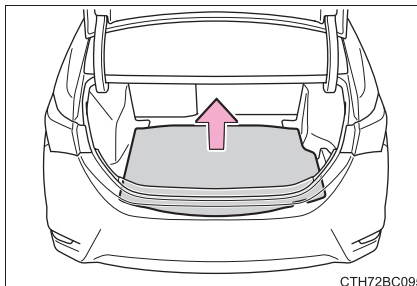

- 2 Take out the emergency tire puncture repair kit. (→P. 534)

### Emergency repair method (type A)

- 1 Take out the emergency tire puncture repair kit from the tool box.
- 2 Remove the valve cap from the valve of the punctured tire.

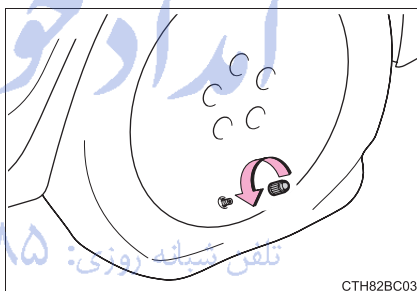

- 3 Remove the protective film from the bottle and extend the hose. Remove the air release cap from the hose.

Attach the stickers enclosed with the bottle on the specified locations. (See step 9.)

You will use the air release cap again. Therefore keep it in a safe place.

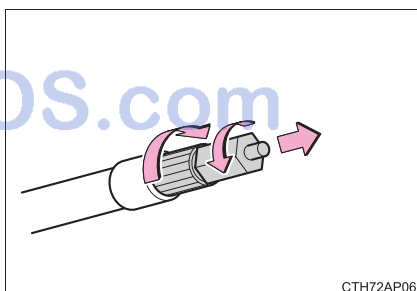

- 4 Connect the hose to the valve.  
Screw the end of the hose clockwise as far as possible.

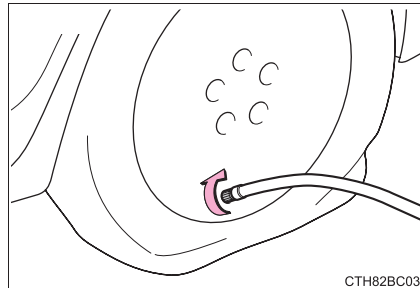

- 5 Make sure that the compressor switch is off.

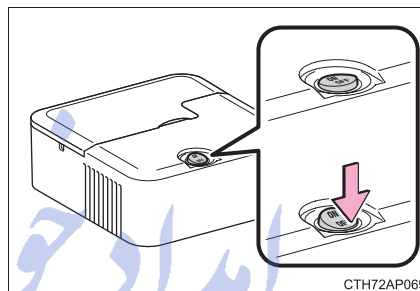

- 6 Remove the power plug from the compressor.

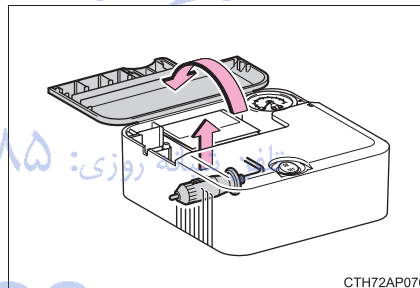

- 7 Connect the power plug to the power outlet socket. (→P. 424)

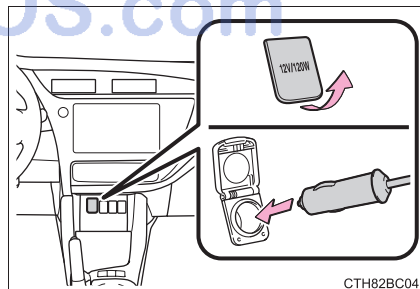

**540** 8-2. Steps to take in an emergency

- 8** Remove the sticker.

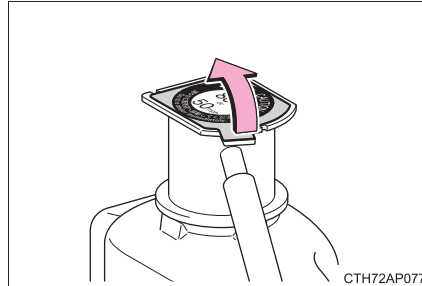

- 9** Attach the 2 stickers as shown.

Remove any dirt and moisture from the wheel before attaching the label. If it is impossible to attach the label, make sure to tell any authorized Toyota dealer or repairer, or other duly qualified and equipped professional when you have them repair and replace the tire that sealant is injected.

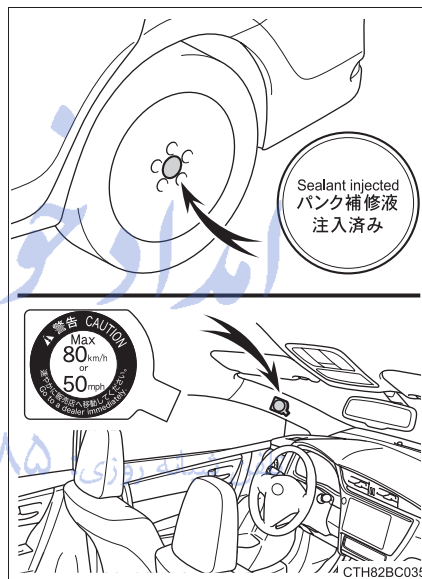

FarmaSOS.com



- 10** Connect the bottle to the compressor.

As shown in the illustration, insert the bottle vertically into the compressor to connect making sure that the claw on the bottle's neck is hooked onto the cutout of the compressor case.

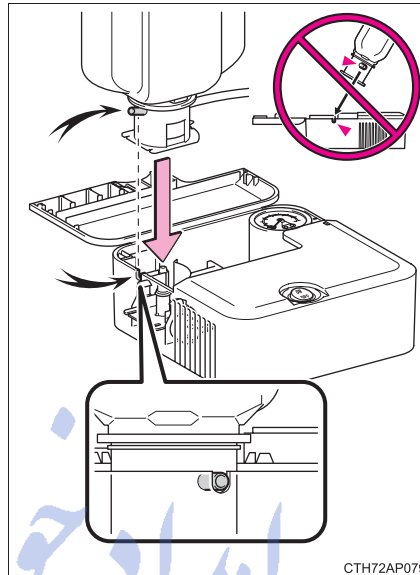

- 11** Check the specified tire inflation pressure.

Tire inflation pressure is specified on the label as shown. (→P. 473)

- 12** Start the vehicle's engine.

- 13** To inject the sealant and inflate the tire, turn the compressor switch on.

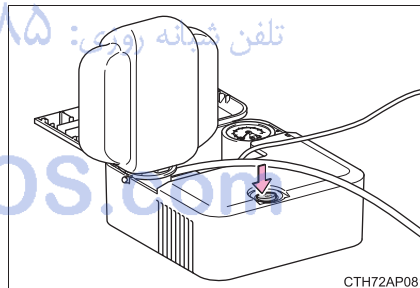

**542** 8-2. Steps to take in an emergency

**14** Inflate the tire until the specified air pressure is reached.

① The sealant will be injected and the pressure will surge and then gradually decrease.

② The air pressure gauge will display the actual tire inflation pressure about 1 minute (5 minutes at low temperature) after the switch is turned on.

③ Inflate the tire until the specified air pressure.

- Turn the compressor switch off and then check the tire inflation pressure. Being careful not to over inflate, check and repeat the inflation procedure until the specified tire inflation pressure is reached.
- If the tire inflation pressure is still lower than the specified point after inflation for 35 minutes with the switch on, the tire is too damaged to be repaired. Turn the compressor switch off and contact any authorized Toyota dealer or repairer, or another duly qualified and equipped professional.
- If the tire inflation pressure exceeds the specified air pressure, let out some air to adjust the tire inflation pressure. (→P. 551, 606)

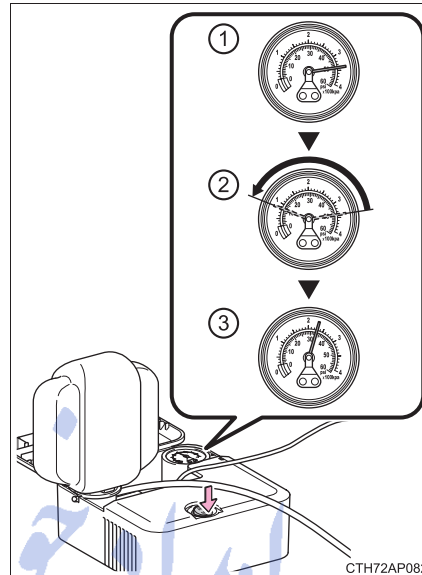

- 15 With the compressor switch off, disconnect the hose from the valve on the tire and then pull out the power plug from the power outlet socket.

Some sealant may leak when the hose is removed.

- 16 Install the valve cap onto the valve of the emergency repaired tire.

- 17 Attach the air release cap to the end of the hose.

If the air release cap is not attached, the sealant may leak and the vehicle may get dirty.

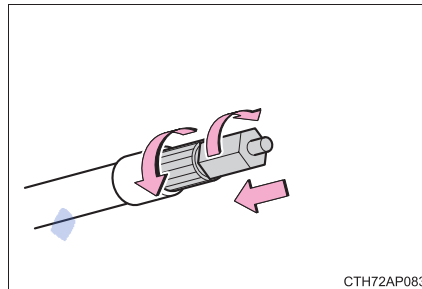

CTH72AP083

- 18 Temporarily store the bottle in the trunk while it is connected to the compressor.

- 19 To spread the liquid sealant evenly within the tire, immediately drive safely for about 5 km (3 miles) below 80 km/h (50 mph).

- 20 After driving for about 5 km (3 miles), stop your vehicle in a safe place on a hard, flat surface and remove the air release cap from the hose before reconnecting the repair kit.

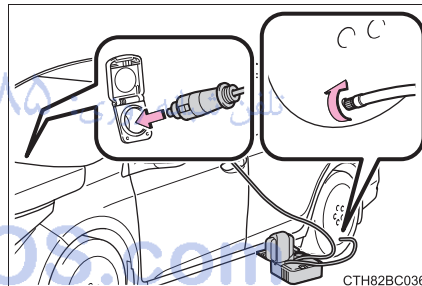

CTH82BC036

**544** 8-2. Steps to take in an emergency

**21** Turn the compressor switch on and wait for an approximately 5 seconds, and then turn it off. Check the tire inflation pressure.

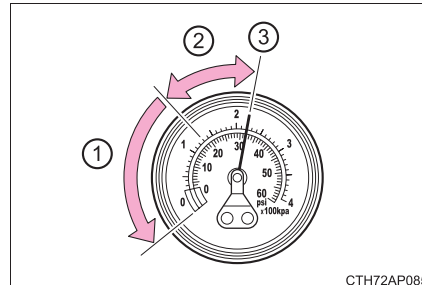

① If the tire inflation pressure is under 130 kPa (1.3 kgf/cm<sup>2</sup> or bar, 19 psi): The puncture cannot be repaired. Contact any authorized Toyota dealer or repairer, or another duly qualified and equipped professional.

② If the tire inflation pressure is 130 kPa (1.3 kgf/cm<sup>2</sup> or bar, 19 psi) or higher, but less than the specified air pressure: Proceed to **22**.

③ If the tire inflation pressure is the specified air pressure (→P. 606): Proceed to **23**.

**22** Turn the compressor switch on to inflate the tire until the specified air pressure is reached. Drive for about 5 km (3 miles) and then perform **20**.

**23** Attach the air release cap to the end of the hose.

If the air release cap is not attached, the sealant may leak and the vehicle may get dirty.

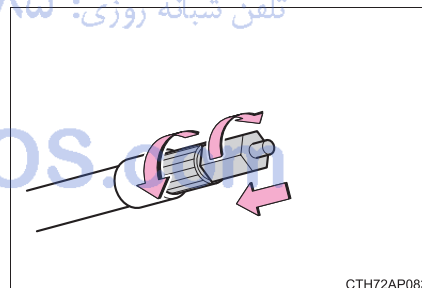

**24** Store the bottle in the trunk while it is connected to the compressor.

**25** Taking precautions to avoid sudden braking, sudden acceleration and sharp turns, drive carefully at under 80 km/h (50 mph) to the nearest authorized Toyota dealer or repairer, or another duly qualified and equipped professional for tire repair or replacement.

**Emergency repair method (type B)**

- 1 Take out the repair kit from the tool box.

When taking out the bottle from the original bag, do not tear or discard the bag.

- 2 Attach the 2 stickers as shown.

Remove any dirt and moisture from the wheel before attaching the label. If it is impossible to attach the label, make sure to tell any authorized Toyota dealer or repairer, or other duly qualified and equipped professional when you have them repair and replace the tire that sealant is injected.

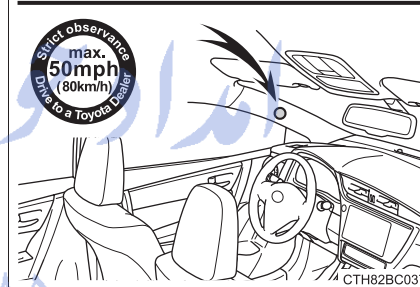
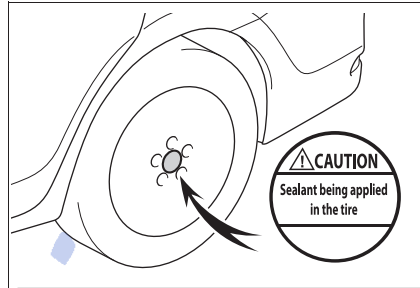

- 3 Remove the valve cap from the valve of the punctured tire.

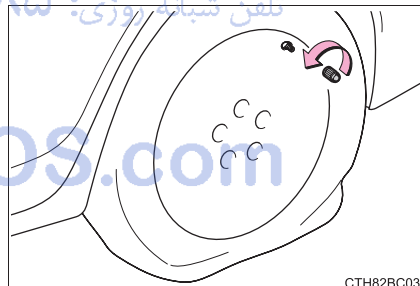

- 4 Connect the nozzle to the valve.

Screw the end of the nozzle clockwise as far as possible.

The bottle should hang vertically without contacting the ground. If the bottle does not hang vertically, move the vehicle so that the tire valve is located properly.

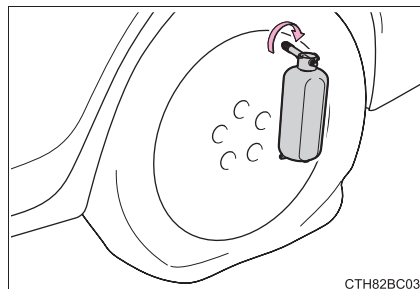

**546** 8-2. Steps to take in an emergency

- 5 Remove the cap from the bottle.

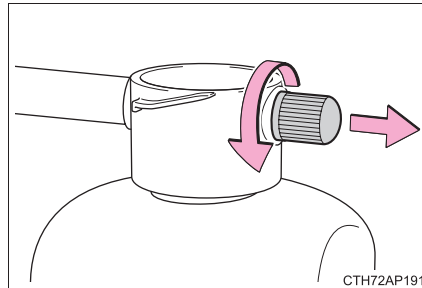

- 6 Pull the hose out from the compressor.

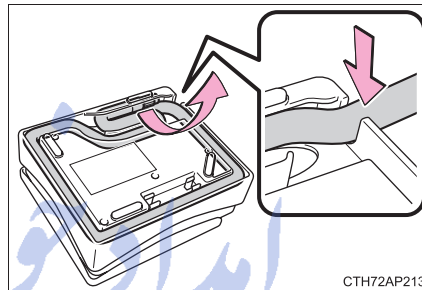

- 7 Connect the bottle to the compressor.  
Screw the end of the nozzle clockwise as far as possible.

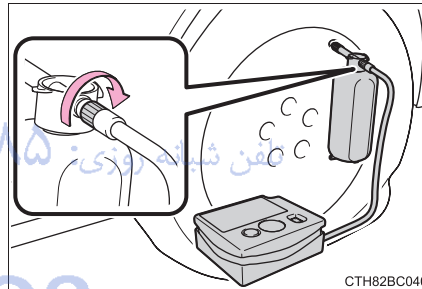

- 8 Make sure that the compressor switch is off.

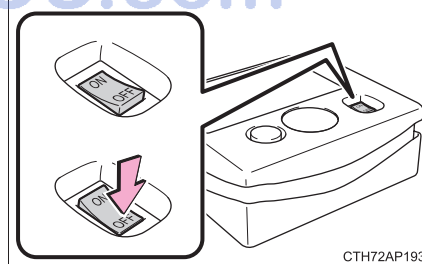

- 9 Remove the power plug from the compressor.

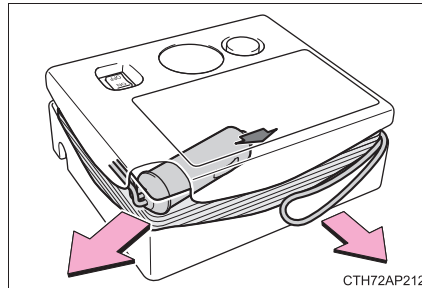

- 10 Connect the power plug to the power outlet socket. (→P. 424)

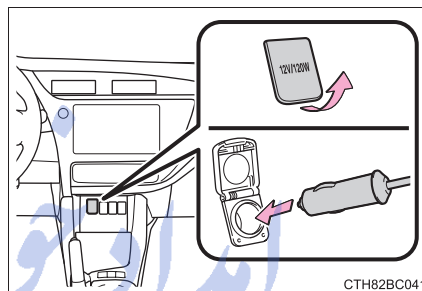

- 11 Check the specified tire inflation pressure.

Tire inflation pressure is specified on the label as shown. (→P. 473)

- 12 Start the vehicle's engine.

- 13 To inject the sealant and inflate the tire, turn the compressor switch on.

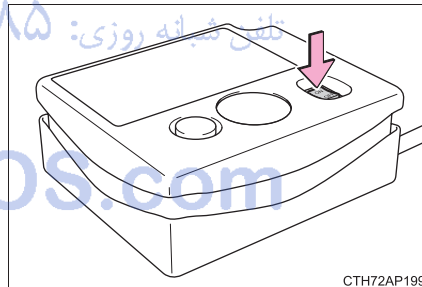

14 Inflate the tire until the specified air pressure is reached.

① The sealant will be injected and the pressure will surge and then gradually decrease.

② The air pressure gauge will display the actual tire inflation pressure about 1 minute (5 minutes at low temperature) after the switch is turned on.

③ Inflate the tire until the specified air pressure.

- If the tire inflation pressure is still lower than the specified point after inflation for 35 minutes with the switch on, the tire is too damaged to be repaired. Turn the compressor switch off and contact any authorized Toyota dealer or repairer, or another duly qualified and equipped professional.

- If the tire inflation pressure exceeds the specified air pressure, let out some air to adjust the tire inflation pressure. (→P. 551, 606)

15 Turn the compressor off, then press the button to release pressure from the bottle.

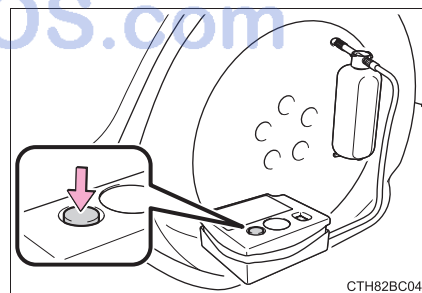
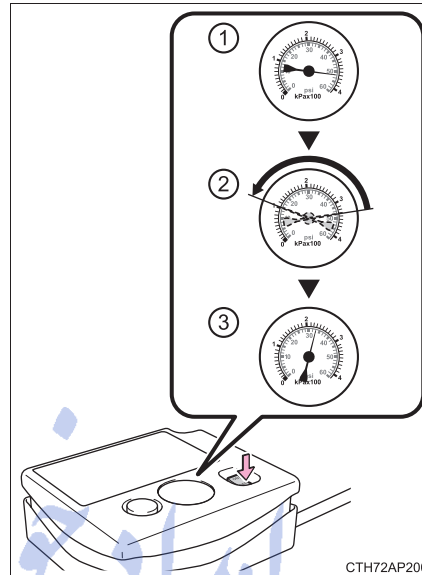

16 Disconnect the nozzle from the valve on the tire and then pull out the power plug from the power outlet socket.

Some sealant may leak when the nozzle is removed.

17 Install the valve cap onto the valve of the repaired tire.



- 18** Disconnect the hose from the bottle and attach the cap to the bottle.

Place the bottle in the original bag and zip it.

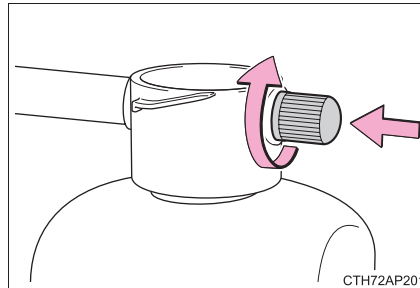

CTH72AP201

- 19** Temporarily store the bottle and compressor in the trunk.
- 20** To spread the liquid sealant evenly within the tire, immediately drive safely for about 5 km (3 miles) below 80 km/h (50 mph).

- 21** After driving for about 5 km (3 miles), stop your vehicle in a safe place on a hard, flat surface and connect the compressor.

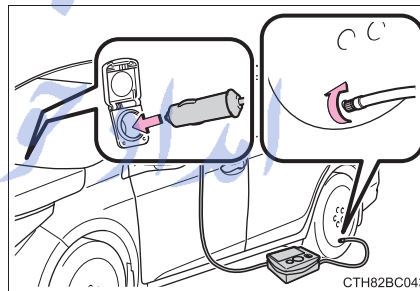

CTH82BC043

- 22** Check the tire inflation pressure.

- ①** If the tire inflation pressure is under 130 kPa (1.3 kgf/cm<sup>2</sup> or bar, 19 psi): The puncture cannot be repaired. Contact any authorized Toyota dealer or repairer, or another duly qualified and equipped professional.

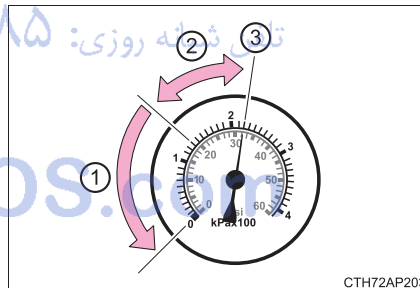

CTH72AP203

- ②** If the tire inflation pressure is 130 kPa (1.3 kgf/cm<sup>2</sup> or bar, 19 psi) or higher, but less than the specified air pressure: Proceed to **23**.
- ③** If the tire inflation pressure is the specified air pressure (→P. 606): Proceed to **24**.
- 23** Turn the compressor switch on to inflate the tire until the specified air pressure is reached. Drive for about 5 km (3 miles) and then perform **21**.
- 24** Store the compressor in the trunk.

- 25 Taking precautions to avoid sudden braking, sudden acceleration and sharp turns, drive carefully at under 80 km/h (50 mph) to the nearest authorized Toyota dealer or repairer, or another duly qualified and equipped professional for tire repair or replacement.

■ If the tire is inflated to more than the specified air pressure

▶ Type A

- 1 Disconnect the hose from the valve.
- 2 Install the air release cap to the end of the hose and push the protrusion on the air release cap into the tire valve to let some air out.

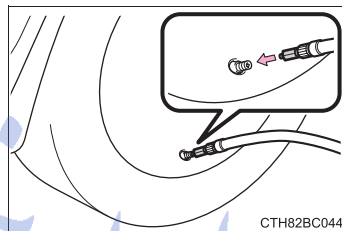

- 3 Disconnect the hose from the valve, remove the air release cap from the hose and then reconnect the hose.
- 4 Turn the compressor switch on and wait for several seconds, and then turn it off. Check that the air pressure indicator shows the specified air pressure. If the air pressure is under the designated pressure, turn the compressor switch on again and repeat the inflation procedure until the specified air pressure is reached.

▶ Type B

- 1 Press the button to let some air out.

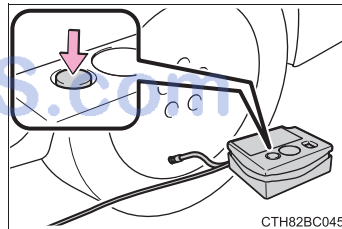

- 2 Check that the air pressure indicator shows the specified air pressure. If the air pressure is under the designated pressure, turn the compressor switch on again and repeat the inflation procedure until the specified air pressure is reached.

**■ After a tire is repaired with the emergency tire puncture repair kit**

- The tire pressure warning valve and transmitter should be replaced.
- Even if the tire inflation pressure is at the recommended level, the tire pressure warning light may come on/flash.

**■ Note for checking the emergency tire puncture repair kit**

Check the sealant expiry date occasionally.

The expiry date is shown on the bottle. Do not use sealant whose expiry date has already passed. Otherwise, repairs conducted using the emergency tire puncture repair kit may not be performed properly.

**■ Emergency tire puncture repair kit**

- The sealant stored in the emergency tire puncture repair kit can be used only once to temporarily repair a single tire. If the sealant has been used and needs to be replaced, purchase a new bottle at any authorized Toyota dealer or repairer, or another duly qualified and equipped professional. The compressor is reusable.
- The sealant can be used when the outside temperature is from  $-30^{\circ}\text{C}$  ( $-22^{\circ}\text{F}$ ) to  $60^{\circ}\text{C}$  ( $140^{\circ}\text{F}$ ).
- The repair kit is exclusively designed for size and type of tires originally installed on your vehicle. Do not use it for tires that a different size than the original ones, or for any other purposes.
- The sealant has a limited lifespan. The expiry date is marked on the bottle. The bottle of sealant should be replaced with a new bottle before the expiry date. Contact any authorized Toyota dealer or repairer, or another duly qualified and equipped professional for replacement.
- If the sealant gets on your clothes, it may stain.
- If the sealant adheres to a wheel or the surface of the vehicle body, the stain may not be removable if it is not cleaned at once. Immediately wipe away the sealant with a wet cloth.
- During operation of the repair kit, a loud operation noise is produced. This does not indicate a malfunction.
- Do not use to check or to adjust the tire pressure.

 **WARNING****■ Do not drive the vehicle with a flat tire**

Do not continue driving with a flat tire.

Driving even a short distance with a flat tire can damage the tire and the wheel beyond repair.

Driving with a flat tire may cause a circumferential groove on the side wall. In such a case, the tire may explode when using a repair kit.

**■ Caution while driving**

- The repair kit is exclusively only for your vehicle.

Do not use repair kit on other vehicles, which could lead to an accident causing death or serious injury.

- Do not use repair kit for tires that are different size than the original ones, or for any other purpose. If the tires have not been completely repaired, it could lead to an accident causing death or serious injury.

**■ Precautions for use of the sealant**

- Ingesting the sealant is hazardous to your health. If you ingest sealant, consume as much water as possible, and then immediately consult a doctor.

- If sealant gets in eyes or adheres to skin, immediately wash it off with water. If discomfort persists, consult a doctor.

**■ When fixing the flat tire**

- Stop your vehicle in a safe and flat area.

- Do not touch the wheels or the area around the brakes immediately after the vehicle has been driven.

After the vehicle has been driven, the wheels and the area around the brakes may be extremely hot. Touching these areas with hands, feet or other body parts may result in burns.

- To avoid risk of burst or severe leakage, do not drop or damage the bottle. Visually inspect the bottle before use. Do not use a bottle with shock, crack, scratch, leakage or any other damage. In such case, immediately replace.

- Connect the valve and hose securely with the tire installed on the vehicle. If the hose is not properly connected to the valve, air leakage may occur as sealant may be sprayed out.

- If the hose comes off the valve while inflating the tire, there is a risk that the hose will move abruptly due to air pressure.

 **WARNING****■ When fixing the flat tire**

- After inflation of the tire has completed, the sealant may splatter when the hose is disconnected or some air is let out of the tire.
- Follow the operation procedure to repair the tire. If the procedures not followed, the sealant may spray out.
- Keep back from the tire while it is being repaired, as there is a chance of it bursting while the repair operation is being performed. If you notice any cracks or deformation of the tire, turn off the compressor switch and stop the repair operation immediately.
- The repair kit may overheat if operated for a long period of time. Do not operate the repair kit continuously for more than 40 minutes.
- Parts of the repair kit become hot during operation. Be careful when handling the repair kit during and after operation. Do not touch the metal part around the connecting area between the bottle and compressor. It will be extremely hot.
- Do not attach the vehicle speed warning sticker to an area other than the one indicated. If the sticker is attached to an area where an SRS airbag is located, such as the pad of the steering wheel, it may prevent the SRS airbag from operating properly.

**■ Driving to spread the liquid sealant evenly**

Observe the following precautions to reduce the risk of accidents. Failing to do so may result in a loss of vehicle control and cause death or serious injury.

- Drive the vehicle carefully at a low speed. Be especially careful when turning and cornering.
- If the vehicle does not drive straight or you feel a pull through the steering wheel, stop the vehicle and check the following.
  - Tire condition. The tire may have separated from the wheel.
  - Tire inflation pressure. If the tire inflation pressure is 130 kPa (1.3 kgf/cm<sup>2</sup> or bar, 19 psi) or less, the tire may be severely damaged.



## NOTICE

**■ When performing an emergency repair**

- A tire should only be repaired with the emergency tire puncture repair kit if the damage is caused by a sharp object such as nail or screw passing through the tire tread.  
Do not remove the sharp object from the tire. Removing the object may widen the opening and disenable emergency repair with the repair kit.
- The repair kit is not waterproof. Make sure that the repair kit is not exposed to water, such as when it is being used in the rain.
- Do not put the repair kit directly onto dusty ground such as sand at the side of the road. If the repair kit vacuums up dust etc., a malfunction may occur.
- Type B: Do not turn the bottle upside down when using it, as doing so may cause damage to the compressor.

**■ Precautions for the emergency tire puncture repair kit**

- The repair kit power source should be 12 V DC suitable for vehicle use. Do not connect the repair kit to any other source.
- If gasoline splatters on the repair kit, the repair kit may deteriorate. Take care not to allow gasoline to contact it.
- Place the repair kit in a storage to prevent it from being exposed to dirt or water.
- Store the repair kit in the tool tray under the luggage floor cover out of reach of children.
- Do not disassemble or modify the repair kit. Do not subject parts such as the air pressure indicator to impacts. This may cause a malfunction.

**■ To avoid damage to the tire pressure warning valves and transmitters**

When a tire is repaired with liquid sealants, the tire pressure warning valve and transmitter may not operate properly. If a liquid sealant is used, contact any authorized Toyota dealer or repairer, or another duly qualified and equipped professional or other qualified service shop as soon as possible. After use of liquid sealant, make sure to replace the tire pressure warning valve and transmitter when repairing or replacing the tire. (→P. 461)

## If you have a flat tire (vehicles with a spare tire)

Your vehicle is equipped with a spare tire. The flat tire can be replaced with the spare tire.

For details about tires: →P. 460

### WARNING

#### ■ If you have a flat tire

Do not continue driving with a flat tire.  
Driving even a short distance with a flat tire can damage the tire and the wheel beyond repair, which could result in an accident.

### Before jacking up the vehicle

- Stop the vehicle in a safe place on a hard, flat surface.
- Set the parking brake.
- Shift the shift lever to P (Multidrive), R (manual transmission) or M, E or R (multi-mode manual transmission).
- Stop the engine.
- Turn on the emergency flashers. (→P. 502)

FarmaSOS.com

8

When trouble arises

### Location of the spare tire, jack and tools

- Vehicles with a compact spare tire (without a tool bag)

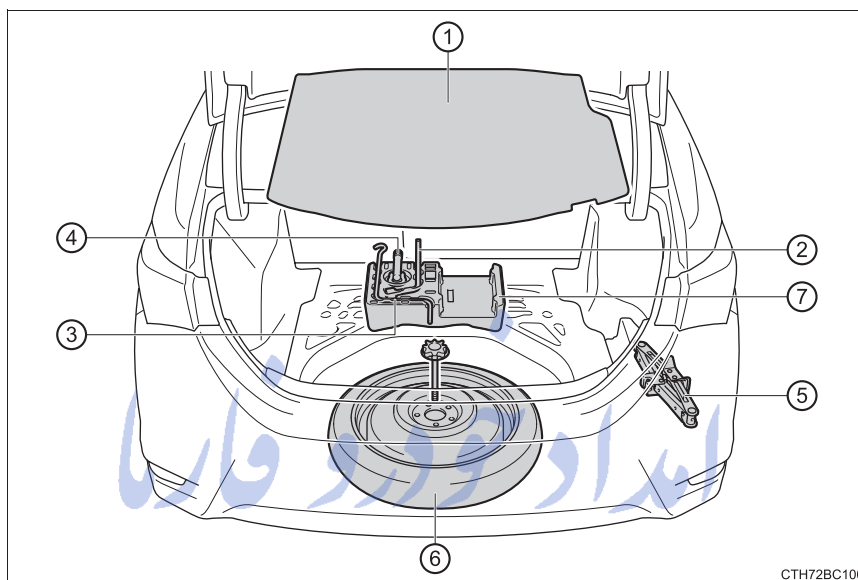

- |                       |              |
|-----------------------|--------------|
| ① Luggage floor cover | ⑤ Jack       |
| ② Wheel nut wrench    | ⑥ Spare tire |
| ③ Jack handle         | ⑦ Tool tray  |
| ④ Towing eyelet       |              |

FarmaSOS.com



## ► Vehicles with a compact spare tire (with a tool bag)

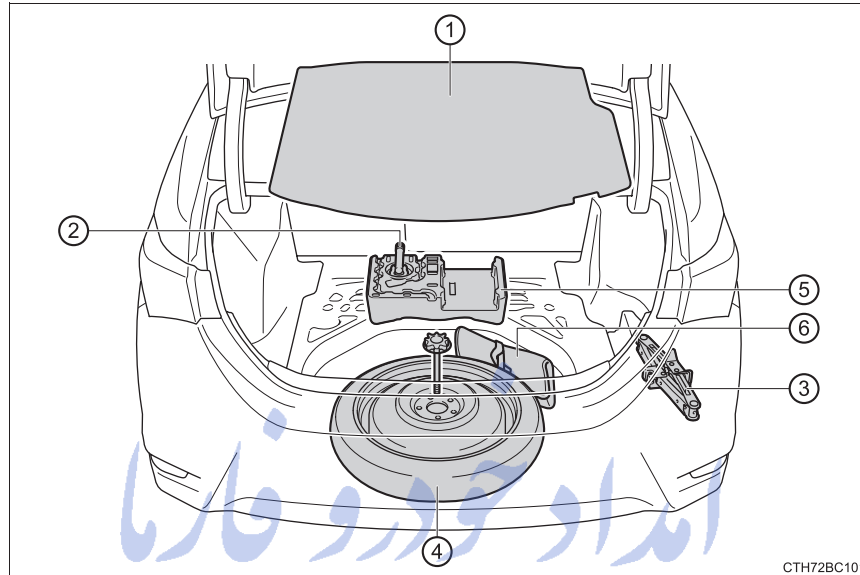

- |                       |              |
|-----------------------|--------------|
| ① Luggage floor cover | ④ Spare tire |
| ② Towing eyelet       | ⑤ Tool tray  |
| ③ Jack                | ⑥ Tool bag   |

تلفن شبانه روزی: ۰۲۱-۸۸۶۲۰۸۵

FarmaSOS.com

**558** 8-2. Steps to take in an emergency

► Vehicles with a full-size spare tire

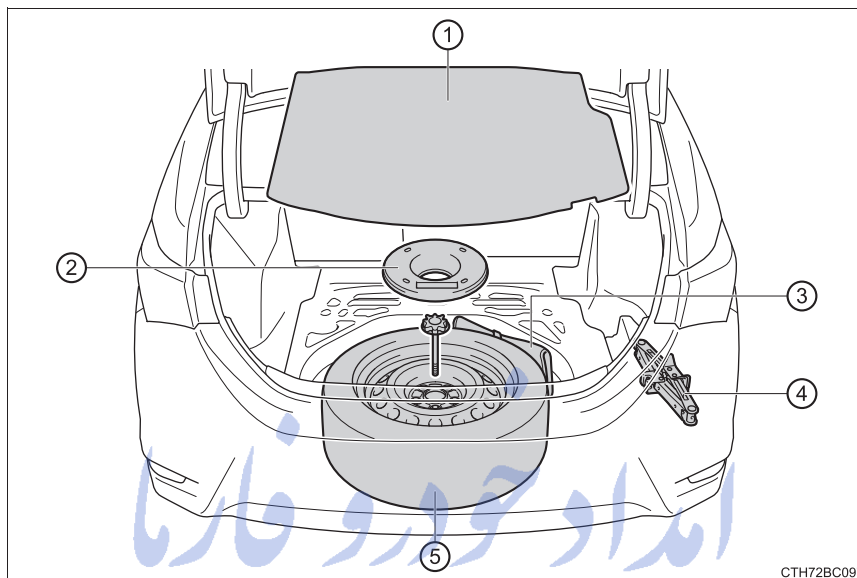

- ① Luggage floor cover
- ② Spare wheel cushion (if equipped)
- ③ Tool bag
- ④ Jack
- ⑤ Spare tire

تلفن شبانه روزی: ۰۸۵-۸۸۶۲۰۲۱

FarmaSOS.com

 **WARNING****■ Using the tire jack**

Observe the following precautions.

Improper use of the tire jack may cause the vehicle to suddenly fall off the jack, leading to death or serious injury.

- Do not use the tire jack for any purpose other than replacing tires or installing and removing tire chains.
- Only use the tire jack that comes with this vehicle for replacing a flat tire. Do not use it on other vehicles, and do not use other tire jacks for replacing tires on this vehicle.
- Put the jack properly in its jack point.
- Do not put any part of your body under the vehicle while it is supported by the jack.
- Do not start the engine or drive the vehicle while the vehicle is supported by the jack.
- Do not raise the vehicle while someone is inside.
- When raising the vehicle, do not put an object on or under the jack.
- Do not raise the vehicle to a height greater than that required to replace the tire.
- Use a jack stand if it is necessary to get under the vehicle.
- When lowering the vehicle, make sure that there is no-one near the vehicle. If there are people nearby, warn them vocally before lowering.

FarmaSOS.com

8

When trouble arises

### Taking out the jack

- 1 Remove the luggage floor cover.

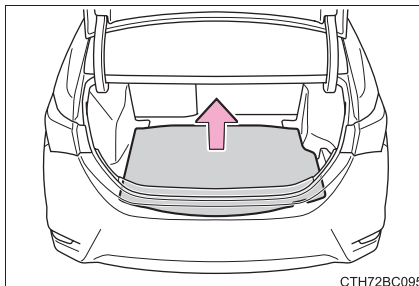

- 2 Remove the jack cover.

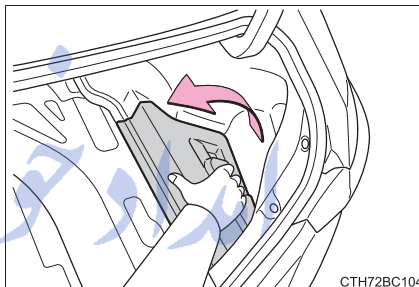

- 3 Take out the jack.

- ① For tightening
- ② For loosening

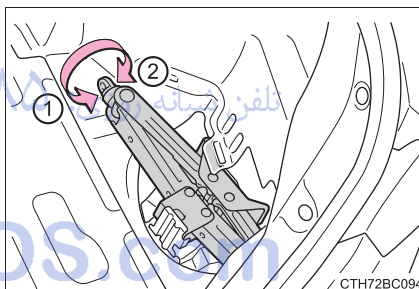

**Taking out the spare tire**

- 1 Remove the luggage floor cover.

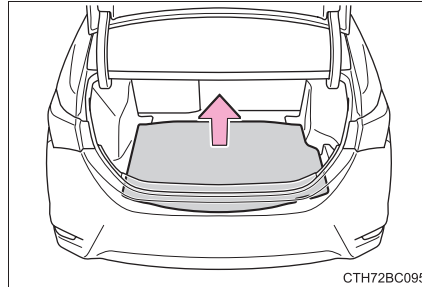

- ▶ Vehicles with a compact spare tire

- 2 Remove the tool tray.

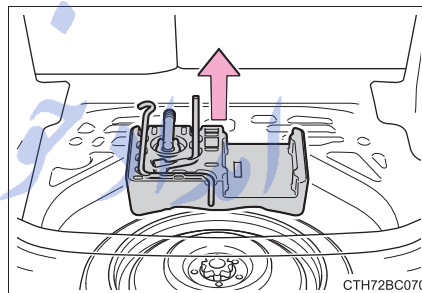

- ▶ Vehicles with a full-size spare tire

- 2 Remove the spare wheel cushion. (if equipped)

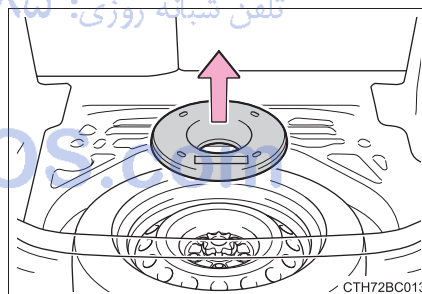

- 3 Loosen the center fastener that secures the spare tire.

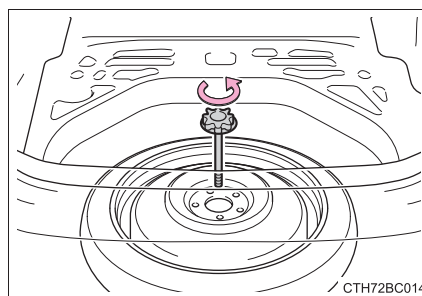

**⚠ WARNING**

**■ When storing the spare tire**

Be careful not to catch fingers or other body parts between the spare tire and the body of the vehicle.

**Replacing a flat tire**

- 1 Chock the tires.

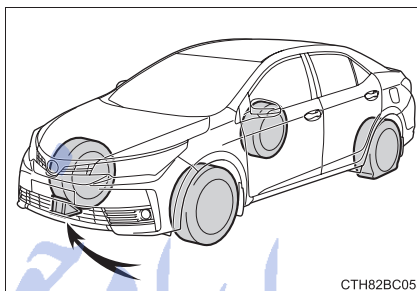

CTH82BC053

Flat tire		Wheel chock positions
Front	Left-hand side	Behind the rear right-hand side tire
	Right-hand side	Behind the rear left-hand side tire
Rear	Left-hand side	In front of the front right-hand side tire
	Right-hand side	In front of the front left-hand side tire

- 2 For vehicles with steel wheels, remove the wheel ornament using the wrench.

To protect the wheel ornament, place a rag between the wrench and the wheel ornament, as shown in the illustration.

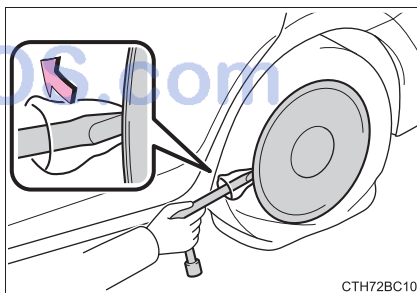

CTH72BC109

- 3 Slightly loosen the wheel nuts (one turn).

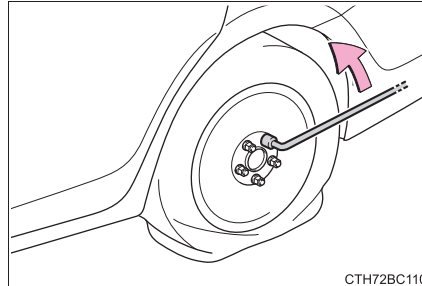

- 4 Turn the tire jack portion "A" by hand until the notch of the jack is in contact with the jack point.

The jack point guides are located under the rocker panel. They indicate the jack point positions.

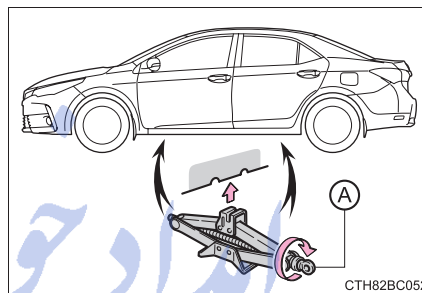

- 5 Raise the vehicle until the tire is slightly raised off the ground.

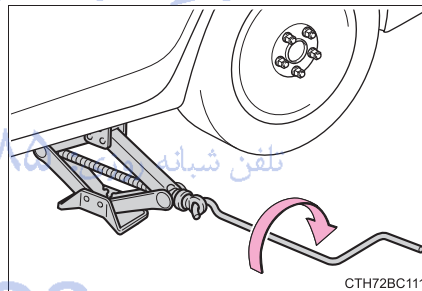

- 6 Remove all the wheel nuts and the tire.

When resting the tire on the ground, place the tire so that the wheel design faces up to avoid scratching the wheel surface.

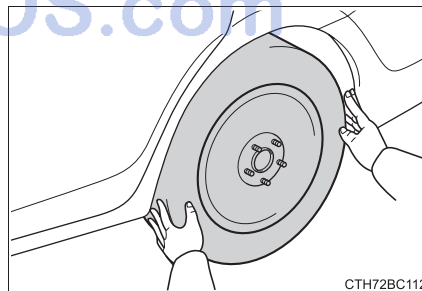

 WARNING

■ Replacing a flat tire

- Do not touch the disc wheels or the area around the brakes immediately after the vehicle has been driven. After the vehicle has been driven the disc wheels and the area around the brakes will be extremely hot. Touching these areas with hands, feet or other body parts while changing a tire, etc. may result in burns.
- Failure to follow these precautions could cause the wheel nuts to loosen and the tire to fall off, resulting in death or serious injury.
  - Have the wheel nuts tightened with a torque wrench to 103 N•m (10.5 kgf•m, 76 ft•lbf) as soon as possible after changing wheels.
  - Do not attach a heavily damaged wheel ornament, as it may fly off the wheel while the vehicle is moving.
  - When installing a tire, only use wheel nuts that have been specifically designed for that wheel.
  - If there are any cracks or deformations in the bolt screws, nut threads or bolt holes of the wheel, have the vehicle inspected by any authorized Toyota dealer or repairer, or another duly qualified and equipped professional.
  - When installing the wheel nuts, be sure to install them with the tapered ends facing inward. (→P. 476)

تلفن شبانه روزی: ۰۲۱-۸۸۸۶۲۰۸۵

FarmaSOS.com



### Installing the spare tire

- 1 Remove any dirt or foreign matter from the wheel contact surface.

If foreign matter is on the wheel contact surface, the wheel nuts may loosen while the vehicle is in motion, causing the tire to come off.

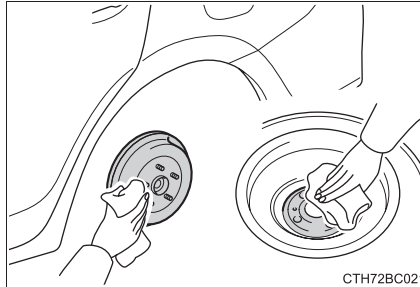

- 2 Install the tire and loosely tighten each wheel nut by hand by approximately the same amount.

When replacing a steel wheel with a steel wheel (including a compact spare tire), tighten the wheel nuts until the tapered portion comes into loose contact with the disc wheel seat.

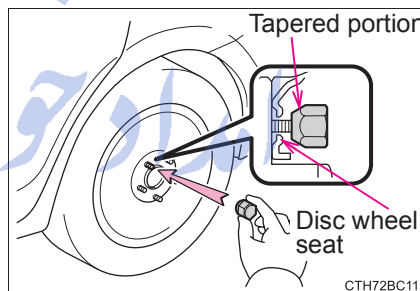

When replacing an aluminum wheel with a steel wheel (including a compact spare tire), tighten the wheel nuts until the tapered portion comes into loose contact with the disc wheel seat.

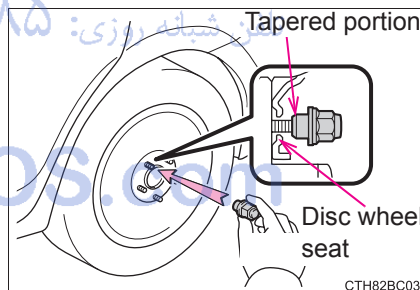

- 3 Lower the vehicle.

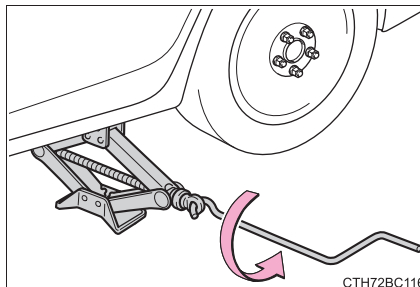

**566** 8-2. Steps to take in an emergency

- 4 Firmly tighten each wheel nut two or three times in the order shown in the illustration.

Tightening torque:  
103 N•m (10.5 kgf•m, 76 ft•lbf)

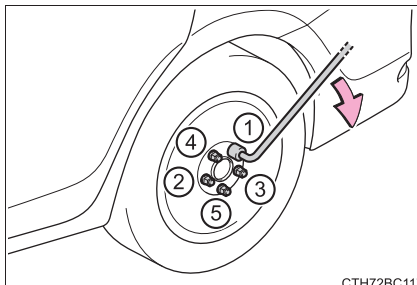

- 5 Vehicles with a full-size spare tire: Reinstall the wheel ornament.

Align the cutout of the wheel ornament with the valve stem as shown.

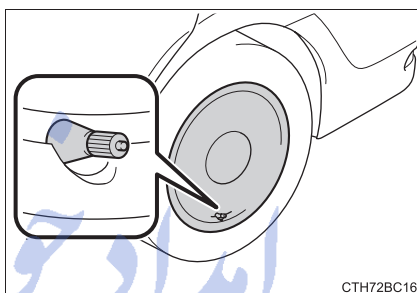

- 6 Stow the flat tire, tire jack and all tools.

تلفن شبانه روزی: ۰۲۱-۸۸۸۶۲۰۸۵

FarmaSOS.com

**■ The full-size spare tire**

- On vehicles with a tire pressure warning system, the full-size spare tire has a "Temporary use only" label on the outer surface of the wheel. Use the full-size spare tire temporarily, and only in an emergency.
- Make sure to check the tire inflation pressure of the full-size spare tire. (→P. 606)

**■ The compact spare tire**

- The compact spare tire is identified by the label "TEMPORARY USE ONLY" on the tire sidewall. Use the compact spare tire temporarily, and only in an emergency.
- Make sure to check the tire inflation pressure of the compact spare tire. (→P. 606)

**■ When the compact spare tire is equipped**

The vehicle becomes lower when driving with the compact spare tire compared to when driving with standard tires.

**■ When using the spare tire**

As the spare tire is not equipped with a tire pressure warning valve and transmitter, low inflation pressure of the spare tire will not be indicated by the tire pressure warning system. Also, if you replace the spare tire after the tire pressure warning light comes on, the light remains on.

**■ If you have a flat front tire on a road covered with snow or ice**

Install the compact spare tire on one of the rear wheels of the vehicle. Perform the following steps and fit tire chains to the front tires:

- 1 Replace a rear tire with the compact spare tire.
- 2 Replace the flat front tire with the tire removed from the rear of the vehicle.
- 3 Fit tire chains to the front tires.

FarmaSOS.com

■ Certification for the jack



**Manufacturer's Declaration of Conformity**

**Manufacturer :**

ARIKAN KRİKO A.Ş  
Organize Sanayi Bölgesi 2.Cd.26110 ESKİŞEHİR / TURKEY

The EU Directives covered by this Declaration

2006 / 42 / EC Machinery Directive

The product covered by this declaration

JACK SUB-ASSY. PANTOGRAPH  
model  
0.8 ton , 1.1 ton

The basis on which conformity is being declared

The product identified above complies with the requirements of  
the Machinery Directive  
Directive above by meeting following standards  
تلفن شبانه روزی: ۰۸۵ ۸۸۶۲۰۸۵

857 – ISO 8720

The technical documentation required to demonstrate that the product  
meets the requirement the Machinery Directive has been compiled by  
the signatory below and is available for inspection by the relevant  
enforcement authorities.  
www.arikan.com

A sample of the product has been tested by the manufacturer

Technical File No :2010-TOYOTA JACK-ISO8720-1

The CE mark was first applied in:2010

Done at Shizuoka , Japan

Ahmet ARIKAN  
General Manager

Signature :

Date of Issue : 24.08.2010

 **WARNING****■ When using the compact spare tire**

- Remember that the compact spare tire provided is specifically designed for use with your vehicle. Do not use your compact spare tire on another vehicle.
- Do not use more than one compact spare tires simultaneously.
- Replace the compact spare tire with a standard tire as soon as possible.
- Avoid sudden acceleration, abrupt steering, sudden braking and shifting operations that cause sudden engine braking.

**■ When the compact spare tire is attached**

The vehicle speed may not be correctly detected, and the following systems may not operate correctly:

- ABS & Brake assist
- VSC
- TRC
- Automatic High Beam (if equipped)
- Cruise control (if equipped)
- EPS
- PCS (if equipped)
- LDA (Lane Departure Alert) (if equipped)

**■ Speed limit when using the compact spare tire**

Do not drive at speeds in excess of 80 km/h (50 mph) when a compact spare tire is installed on the vehicle.

The compact spare tire is not designed for driving at high speeds. Failure to observe this precaution may lead to an accident causing death or serious injury.

**■ After using the tools and jack**

Before driving, make sure all the tools and jack are securely in place in their storage location to reduce the possibility of personal injury during a collision or sudden braking.

 NOTICE

■ **Be careful when driving over bumps with the compact spare tire installed on the vehicle.**

The vehicle becomes lower when driving with the compact spare tire compared to when driving with standard tires. Be careful when driving over uneven road surfaces.

■ **Driving with tire chains and the compact spare tire**

Do not fit tire chains to the compact spare tire.  
Tire chains may damage the vehicle body and adversely affect driving performance.

■ **When replacing the tires**

When removing or fitting the wheels, tires or the tire pressure warning valve and transmitter, contact any authorized Toyota dealer or repairer, or another duly qualified and equipped professional as the tire pressure warning valve and transmitter may be damaged if not handled correctly.

■ **To avoid damage to the tire pressure warning valves and transmitters**

When a tire is repaired with liquid sealants, the tire pressure warning valve and transmitter may not operate properly. If a liquid sealant is used, contact any authorized Toyota dealer or repairer, or another duly qualified and equipped professional or other qualified service shop as soon as possible. Make sure to replace the tire pressure warning valve and transmitter when replacing the tire. (→P. 461)

تلفن شبانه روزی: ۰۲۱ ۸۸۸۶۲۰۸۵

FarmaSOS.com

## If the engine will not start

If the engine will not start even though correct starting procedures are being followed (→P. 196, 199), consider each of the following points:

### The engine will not start even though the starter motor operates normally.

One of the following may be the cause of the problem:

- There may not be sufficient fuel in the vehicle's tank.  
Refuel the vehicle.
- The engine may be flooded.  
Try to restart the engine again following correct starting procedures.  
(→P. 196, 199)
- There may be a malfunction in the engine immobilizer system.  
(→P. 77)

### The starter motor turns over slowly, the interior lights and headlights are dim, or the horn does not sound or sounds at a low volume.

One of the following may be the cause of the problem:

- The battery may be discharged. (→P. 578)
- The battery terminal connections may be loose or corroded.

### The starter motor does not turn over (vehicles with a smart entry & start system)

The engine starting system may be malfunctioning due to an electrical problem such as electronic key battery depletion or a blown fuse. However, an interim measure is available to start the engine.  
(→P. 572)

**The starter motor does not turn over, the interior lights and headlights do not turn on, or the horn does not sound.**

One of the following may be the cause of the problem:

- One or both of the battery terminals may be disconnected.
- The battery may be discharged. (→P. 578)
- There may be a malfunction in the steering lock system.

Contact any authorized Toyota dealer or repairer, or another duly qualified and equipped professional if the problem cannot be repaired, or if repair procedures are unknown.

**Emergency start function (vehicles with a smart entry & start system)**

When the engine does not start, the following steps can be used as an interim measure to start the engine if the engine switch is functioning normally:

- 1 Set the parking brake.
- 2 Shift the shift lever to P (Multidrive) or N (multi-mode manual transmission or manual transmission).
- 3 Turn the engine switch to ACCESSORY mode.
- 4 Press and hold the engine switch for about 15 seconds while depressing the brake pedal and clutch pedal (manual transmission) firmly.

Even if the engine can be started using the above steps, the system may be malfunctioning. Have the vehicle inspected by any authorized Toyota dealer or repairer, or another duly qualified and equipped professional.



## If the shift lever cannot be shifted from P (vehicles with a Multidrive)

If the shift lever cannot be shifted with your foot on the brake pedal, there may be a problem with the shift lock system (a system to prevent accidental operation of the shift lever). Have the vehicle inspected by any authorized Toyota dealer or repairer, or another duly qualified and equipped professional immediately. The following steps may be used as an emergency measure to ensure that the shift lever can be shifted:

- 1 Set the parking brake.
- 2 Vehicles without a smart entry & start system: Turn the engine switch to the "ACC" position.  
Vehicles with a smart entry & start system: Turn the engine switch to ACCESSORY mode.

- 3 Depress the brake pedal.

- 4 Pry the cover up with a flathead screwdriver or equivalent tool.

To prevent damage to the cover, cover the tip of the screwdriver with a rag.

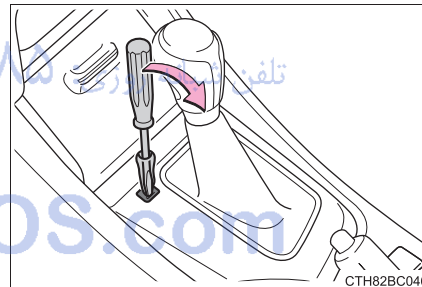

- 5 Press the shift lock override button.

The shift lever can be shifted while the button is pressed.

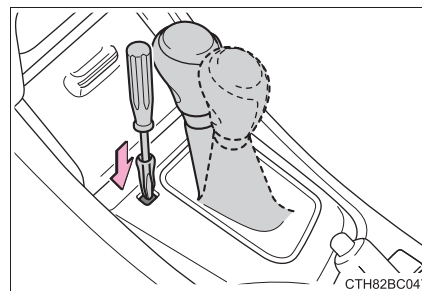

### If the shift lever cannot be shifted (vehicles with a multi-mode manual transmission)

If the shift lever cannot be shifted with your foot on the brake, there may be a problem with the shift lock system (a system to prevent accidental operation of the shift lever). Have the vehicle inspected by any authorized Toyota dealer or repairer, or another duly qualified and equipped professional, immediately. The following steps may be used as an emergency measure to ensure that the shift lever can be shifted.

- 1 Set the parking brake.
- 2 Start the engine.
- 3 Depress the brake pedal.
- 4 Press the shift lock override button with a flathead screwdriver or equivalent.

The shift lever can be shifted while the button is pressed.

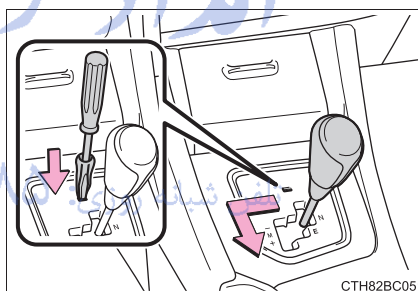

FarmaSOS.com

### If the electronic key does not operate properly (vehicles with a smart entry & start system)

If communication between the electronic key and vehicle is interrupted (→P. 142) or the electronic key cannot be used because the battery is depleted, the smart entry & start system and wireless remote control cannot be used. In such cases, the doors can be opened and the engine can be started by following the procedure below.

#### Locking and unlocking the doors

Use the mechanical key (→P. 118) in order to perform the following operations:

- ① Locks all the doors
- ② Unlocks all the doors

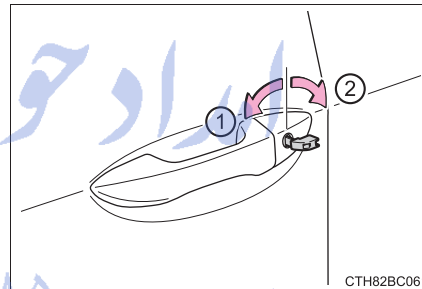

تلفن شبانه روزی: ۰۲۱-۸۸۶۲۰۸۵

FarmaSOS.com

### Starting the engine

- 1 Multidrive: Ensure that the shift lever is in P and depress the brake pedal.

Multi-mode manual transmission: Ensure that the shift lever is in N and depress the brake pedal.

Manual transmission: Shift the shift lever to N and depress the clutch pedal.

- 2 Touch the Toyota emblem side of the electronic key to the engine switch.

When the electronic key is detected, a buzzer sounds and the engine switch will turn to IGNITION ON mode.

When the smart entry & start system is deactivated in customization setting, the engine switch will turn to ACCESSORY mode.

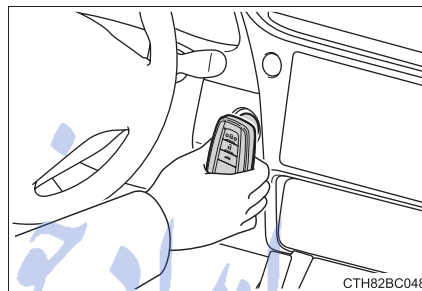

- 3 Vehicles with a drive monitor display: Firmly depress the brake pedal (Multidrive or multi-mode manual transmission) or clutch pedal (manual transmission) and check that the smart entry & start system indicator light (green) turns on.

Vehicles with a multi-information display: Firmly depress the brake pedal (Multidrive or multi-mode manual transmission) or clutch

pedal (manual transmission) and check that  is shown on the multi-information display.

- 4 Press the engine switch.

In the event that the engine still cannot be started, contact any authorized Toyota dealer or repairer, or another duly qualified and equipped professional.

**■ Stopping the engine**

Shift the shift lever to P (Multidrive) or N (manual transmission or multi-mode manual transmission) and press the engine switch as you normally do when stopping the engine.

**■ Replacing the key battery**

As the above procedure is a temporary measure, it is recommended that the electronic key battery be replaced immediately when the battery is depleted. (→P. 480)

**■ Changing engine switch modes**

Release the brake pedal (Multidrive or multi-mode manual transmission) or clutch pedal (manual transmission) and press the engine switch in step 3 above.

The engine does not start and modes will be changed each time the switch is pressed. (→P. 202)

**■ When the electronic key does not work properly**

- Make sure that the smart entry & start system has not been deactivated in the customization setting. If it is off, turn the function on. (Customizable features →P. 611)
- Check if battery-saving mode is set. If it is set, cancel the function. (→P. 141)

تلفن شبانه روزی: ۰۲۱-۸۸۸۶۲۰۸۵

FarmaSOS.com

## If the vehicle battery is discharged

The following procedures may be used to start the engine if the vehicle's battery is discharged.

You can also call any authorized Toyota dealer or repairer, or another duly qualified and equipped professional or a qualified repair shop.

If you have a set of jumper (or booster) cables and a second vehicle with a 12-volt battery, you can jump start your vehicle by following the steps below.

- 1 Open the hood. (→P. 441)
- 2 Vehicles with 1ZR-FAE or 1ND-TV engine, remove the engine cover.

### ► 1ZR-FAE engine

Raise the rear of the engine cover to remove the two rear clips, and then raise the front of the engine cover to remove the two front clips.

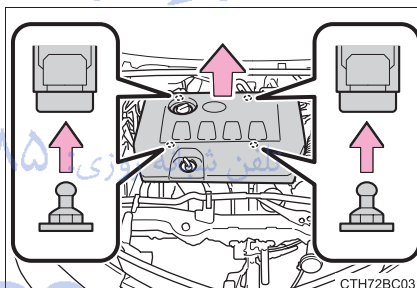

CTH72BC031

### ► 1ND-TV engine

Raise the front of the engine cover to detach it from the clips and then pull the cover to detach it from the brackets on the rear bar as shown in the illustration.

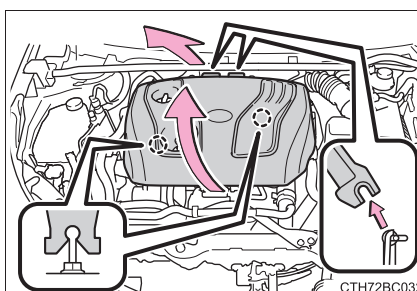

CTH72BC032

- 3 Connect the jumper cables according to the following procedure:
- ▶ 1NR-FE engine

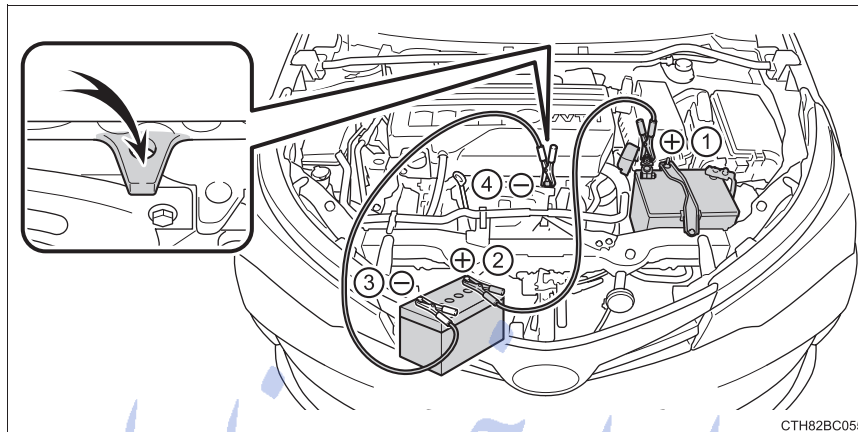

- 1 Connect a positive jumper cable clamp to the positive (+) battery terminal on your vehicle.
- 2 Connect the clamp on the other end of the positive cable to the positive (+) battery terminal on the second vehicle.
- 3 Connect a negative cable clamp to the negative (-) battery terminal on the second vehicle.
- 4 Connect the clamp at the other end of the negative cable to a solid, stationary, unpainted metallic point away from the battery and any moving parts, as shown in the illustration.

FarmaSOS.com

► 1ZR-FAE engine

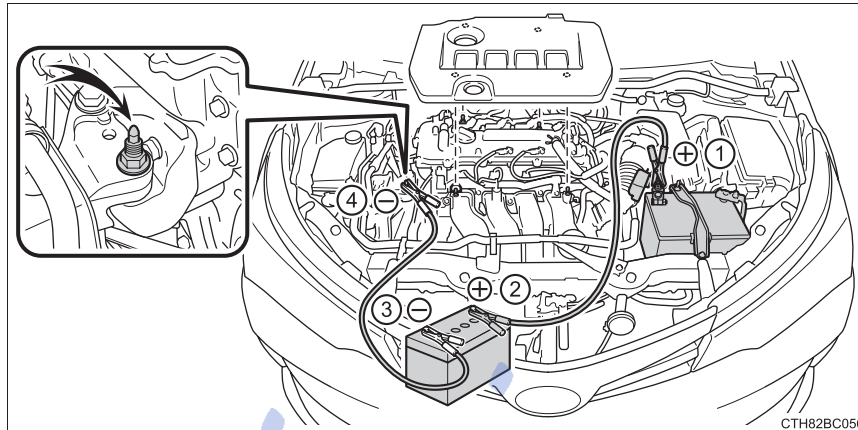

- ① Connect a positive jumper cable clamp to the positive (+) battery terminal on your vehicle.
- ② Connect the clamp on the other end of the positive cable to the positive (+) battery terminal on the second vehicle.
- ③ Connect a negative cable clamp to the negative (-) battery terminal on the second vehicle.
- ④ Connect the clamp at the other end of the negative cable to a solid, stationary, unpainted metallic point away from the battery and any moving parts, as shown in the illustration.

FarmaSOS.com



## ▶ 1ND-TV engine

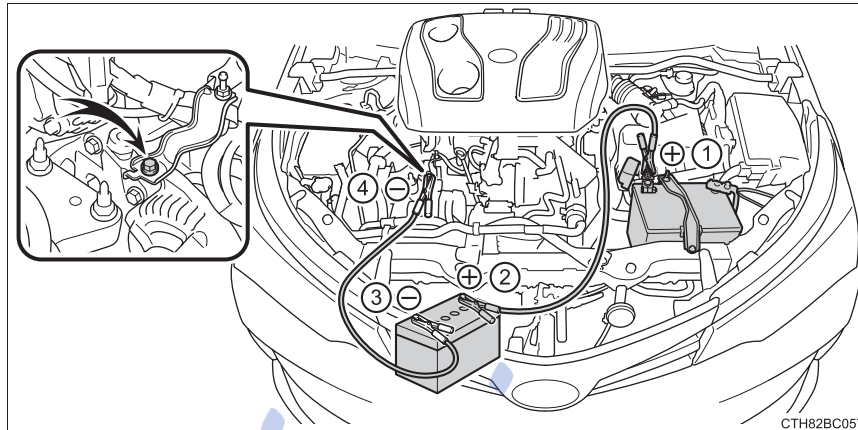

- ① Connect a positive jumper cable clamp to the positive (+) battery terminal on your vehicle.
- ② Connect the clamp on the other end of the positive cable to the positive (+) battery terminal on the second vehicle.
- ③ Connect a negative cable clamp to the negative (-) battery terminal on the second vehicle.
- ④ Connect the clamp at the other end of the negative cable to a solid, stationary, unpainted metallic point away from the battery and any moving parts, as shown in the illustration.
- 4 Start the engine of the second vehicle. Increase the engine speed slightly and maintain at that level for approximately 5 minutes to recharge the battery of your vehicle.
- 5 Vehicles with a smart entry & start system: Open and close any of the doors of your vehicle with the engine switch off.
- 6 Vehicles without a smart entry & start system:
 

Maintain the engine speed of the second vehicle and turn the engine switch to the "ON" position, then start the vehicle's engine.

Vehicles with a smart entry & start system:  
 Maintain the engine speed of the second vehicle and turn the engine switch to IGNITION ON mode, then start the vehicle's engine.

- 7 Once the vehicle's engine has started, remove the jumper cables in the exact reverse order from which they were connected.

Once the engine starts, have the vehicle inspected at any authorized Toyota dealer or repairer, or another duly qualified and equipped professional as soon as possible.

---

■ **Starting the engine when the battery is discharged**

The engine cannot be started by push-starting.

■ **To prevent battery discharge**

- Turn off the headlights and the audio system while the engine is stopped. (Vehicles with a Stop & Start system: except when the engine is stopped by the Stop & Start system.)
- Turn off any unnecessary electrical components when the vehicle is running at a low speed for an extended period, such as in heavy traffic.

■ **Charging the battery**

The electricity stored in the battery will discharge gradually even when the vehicle is not in use, due to natural discharge and the draining effects of certain electrical appliances. If the vehicle is left for a long time, the battery may discharge, and the engine may be unable to start. (The battery recharges automatically during driving.)

■ **When recharging or replacing the battery**

- Vehicles with a smart entry & start system: In some cases, it may not be possible to unlock the doors using the smart entry & start system when the battery is discharged. Use the wireless remote control or the mechanical key to lock or unlock the doors.
- The engine may not start on the first attempt after the battery has recharged but will start normally after the second attempt. This is not a malfunction.
- Vehicles with a Stop & Start system: For a while after the battery terminals have been disconnected and reconnected, for a while after the battery has been replaced, the Stop & Start system may not automatically stop the engine for approximately 5 to 60 minutes.

■ **When exchanging the battery (vehicles with a Stop & Start system)**

Use a battery specified for use with the Stop & Start system and equivalent to a genuine battery. If an unsupported battery is used, Stop & Start system functions may be restricted to protect the battery.

Also, battery performance may decrease and the engine may not be able to restart. Contact any authorized Toyota retailers or Toyota authorized repairers, or any reliable repairers for details.

 WARNING**■ Avoiding battery fires or explosions**

Observe the following precautions to prevent accidentally igniting the flammable gas that may be emitted from the battery:

- Make sure each jumper cable is connected to the correct terminal and that it is not unintentionally in contact with any other than the intended terminal.
- Do not allow the other end of the jumper cable connected to the “+” terminal to come into contact with any other parts or metal surfaces in the area, such as brackets or unpainted metal.
- Do not allow the + and - clamps of the jumper cables to come into contact with each other.
- Do not smoke, use matches, cigarette lighters or allow open flame near the battery.

**■ Battery precautions**

The battery contains poisonous and corrosive acidic electrolyte, while related parts contain lead and lead compounds. Observe the following precautions when handling the battery:

- When working with the battery, always wear safety glasses and take care not to allow any battery fluids (acid) to come into contact with skin, clothing or the vehicle body.
- Do not lean over the battery.
- In the event that battery fluid comes into contact with the skin or eyes, immediately wash the affected area with water and seek medical attention. Place a wet sponge or cloth over the affected area until medical attention can be received.
- Always wash your hands after handling the battery support, terminals, and other battery-related parts.
- Do not allow children near the battery.

 NOTICE**■ When handling jumper cables**

When connecting the jumper cables, ensure that they do not become entangled in the cooling fan or engine drive belt.

## If your vehicle overheats

The following may indicate that your vehicle is overheating.

- Vehicles with a drive monitor display: The high engine coolant temperature warning light (→P. 513) comes on or a loss of power is experienced.  
Vehicles with a multi-information display: The engine coolant temperature gauge (→P. 101) enters the red zone or a loss of power is experienced.
- Steam comes out from under the hood.

### Correction procedures

- 1 Stop the vehicle in a safe place and turn off the air conditioning system, and then stop the engine.
- 2 If you see steam:  
Carefully lift the hood after the steam subsides.  
If you do not see steam:  
Carefully lift the hood.
- 3 After the engine has cooled down sufficiently, inspect the hoses and radiator core (radiator) for any leaks.

- 1 Radiator
- 2 Cooling fan

If a large amount of coolant leaks, immediately contact any authorized Toyota dealer or repairer, or another duly qualified and equipped professional.

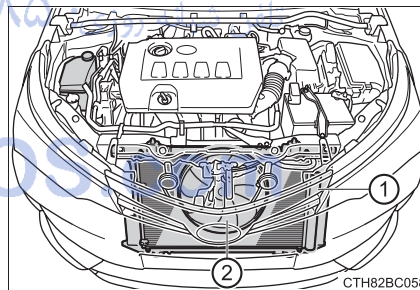

- 4 The coolant level is satisfactory if it is between the “FULL” and “LOW” lines on the reservoir.

- ① Reservoir
- ② “FULL” line
- ③ “LOW” line

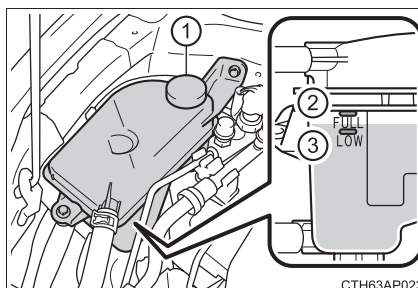

- 5 Add engine coolant if necessary.

Water can be used in an emergency if engine coolant is unavailable.

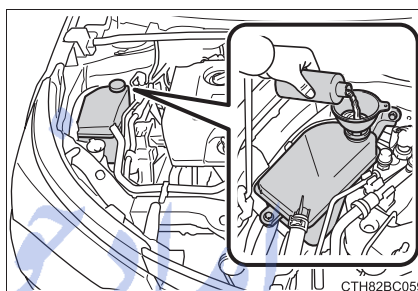

- 6 Start the engine and turn the air conditioning system on to check that the radiator cooling fan operate and to check for coolant leaks from the radiator or hoses.

The fan operate when the air conditioning system is turned on immediately after a cold start. Confirm that the fan is operating by checking the fan sound and air flow. If it is difficult to check these, turn the air conditioning system on and off repeatedly. (The fan may not operate in freezing temperatures.)

- 7 If the fan is not operating:

Stop the engine immediately and contact any authorized Toyota dealer or repairer, or another duly qualified and equipped professional.

If the fan is operating:

Have the vehicle inspected at the nearest authorized Toyota dealer or repairer, or another duly qualified and equipped professional, as soon as possible.

 WARNING**■ When inspecting under the hood of your vehicle**

Observe the following precautions.

Failure to do so may result in serious injury such as burns.

- If steam is seen coming from under the hood, do not open the hood until the steam has subsided. The engine compartment may be very hot.
- Keep hands and clothing (especially a tie, a scarf or a muffler) away from the fan and belts.
- Do not loosen the coolant reservoir cap while the engine and radiator are hot.

 NOTICE**■ When adding engine coolant**

Add coolant slowly after the engine has cooled down sufficiently. Adding cool coolant to a hot engine too quickly can cause damage to the engine.

**■ To prevent damage to the cooling system**

Observe the following precautions:

- Avoid contaminating the coolant with foreign matter (such as sand or dust etc.).
- Do not use any coolant additives.

FarmaSOS.com

## If you run out of fuel and the engine stalls (diesel engine)

### If you run out of fuel and the engine dies:

- 1 Refuel your vehicle.
- 2 Operate the priming pump until you feel more resistance to bleed the fuel system.

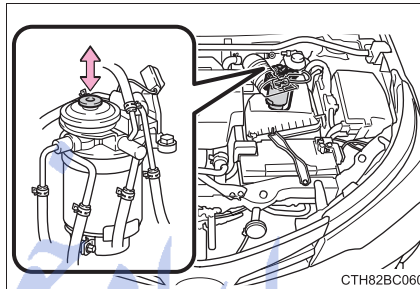

- 3 Start the engine. (→P. 196, 199)

If the engine does not start after the above steps have been performed, wait for 10 seconds and try step 2 and 3 again. If the engine still does not start, contact any authorized Toyota dealer or repairer, or another duly qualified and equipped professional.

After starting the engine, depress the accelerator pedal lightly until the engine runs smoothly.

#### ⚠ NOTICE

##### ■ When restarting the engine

- Do not crank the engine before refueling and operating the priming pump. This may damage the engine and fuel system.
- Vehicles without a smart entry & start system: Do not crank for more than 30 seconds at a time. This may overheat the starter and wiring system.

## If the vehicle becomes stuck

Carry out the following procedures if the tires spin or the vehicle becomes stuck in mud, dirt or snow:

- 1 Stop the engine. Set the parking brake and shift the shift lever to P (Multidrive) or N (manual transmission and multi-mode manual transmission).
- 2 Remove the mud, snow or sand from around the front wheels.
- 3 Place wood, stones or some other material under the front wheels to help provide traction.
- 4 Restart the engine.
- 5 Shift the shift lever to D or R (Multidrive) or 1 or R (manual transmission and multi-mode manual transmission) and release the parking brake. Then, while exercising caution, depress the accelerator pedal.

تلفن شبانه روزی: ۰۲۱-۸۸۶۲۰۸۵

FarmaSOS.com



### ■ When it is difficult to free the vehicle

Press  to turn off TRC.

\*1: Vehicles with a drive monitor display

\*2: Vehicles with a multi-information display

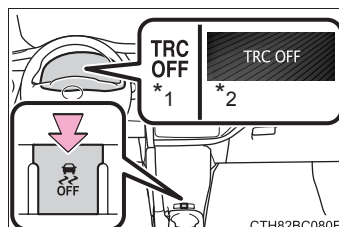

### ⚠ WARNING

#### ■ When attempting to free a stuck vehicle

If you choose to push the vehicle back and forth to free it, make sure the surrounding area is clear to avoid striking other vehicles, objects or people. The vehicle may also lunge forward or lunge back suddenly as it becomes free. Use extreme caution.

#### ■ When shifting the shift lever

Be careful not to shift the shift lever with the accelerator pedal depressed. This may lead to unexpected rapid acceleration of the vehicle that may cause an accident resulting in death or serious injury.

### ⚠ NOTICE

#### ■ To avoid damaging the transmission and other components

- Avoid spinning the front wheels and depressing the accelerator pedal more than necessary.
- If the vehicle remains stuck even after these procedures are performed, the vehicle may require towing to be freed.

امداد خودرو فارما

تلفن شبانه روزی: ۰۲۱-۸۸۸۶۲۰۸۵

FarmaSOS.com

## Vehicle specifications

## 9

**9-1. Specifications**

Maintenance data (fuel, oil level, etc.).....	592
Fuel information.....	609

**9-2. Customization**

Customizable features.....	611
----------------------------	-----

**9-3. Initialization**

Items to initialize.....	618
--------------------------	-----

امداد خودرو فارما

تلفن شبانه روزی: ۰۲۱-۸۸۸۶۲۰۸۵

FarmaSOS.com

## Maintenance data (fuel, oil level, etc.)

### Dimensions and weights

Overall length		4620 mm (181.9 in.)
Overall width		1775 mm (69.9 in.)
Overall height*1		1465 mm (57.7 in.) 1485 mm (58.5 in.)*2
Wheelbase		2700 mm (106.3 in.)
Tread	Front	1535 mm (60.4 in.)*3 1525 mm (60.0 in.)*4 1515 mm (59.6 in.)*5
	Rear	1535 mm (60.4 in.)*3 1520 mm (59.8 in.)*4 1510 mm (59.4 in.)*5
Gross vehicle mass		► 1NR-FE engine 1735 kg (3826 lb.) ► 1ZR-FAE engine 1775 kg (3913 lb.) ► 1ND-TV engine 1795 kg (3957 lb.)
Maximum permissible axle capacity	Front	1020 kg (2249 lb.)
	Rear	915 kg (2017 lb.)
Drawbar load		55 kg (121 lb.)
Towing capacity	With brake	► 1NR-FE and 1ND-TV engines 1000 kg (2205 lb.) ► 1ZR-FAE engine 1300 kg (2867 lb.)
	Without brake	450 kg (992 lb.)

\*1: Unladen vehicles

\*2: Vehicles with raised vehicle height

\*3: Vehicles with 195/65R15 tires

\*4: Vehicles with 205/55R16 tires

\*5: Vehicles with 215/45R17 tires

**Vehicle identification****■ Vehicle identification number**

The vehicle identification number (VIN) is the legal identifier for your vehicle. This is the primary identification number for your Toyota. It is used in registering the ownership of your vehicle.

This number is stamped under the right-hand front seat.

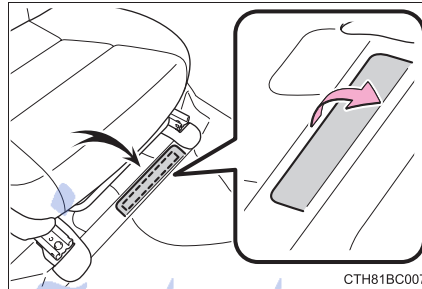

This number is also on the manufacturer's label.

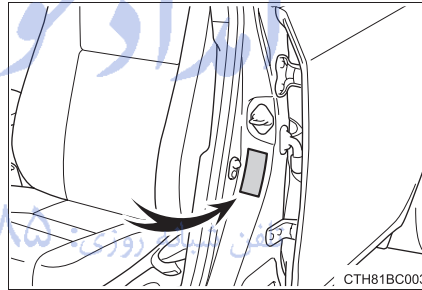

FarmaSOS.com

■ **Engine number**

The engine number is stamped on the engine block as shown.

▶ 1NR-FE engine

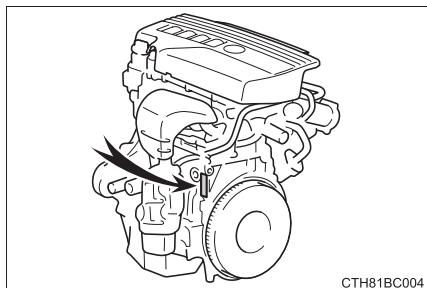

▶ 1ZR-FAE engine

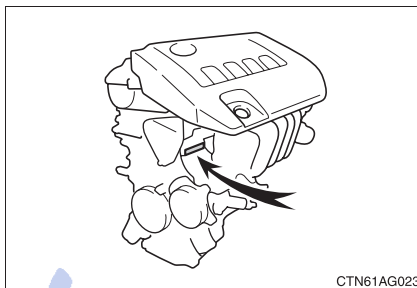

▶ 1ND-TV engine

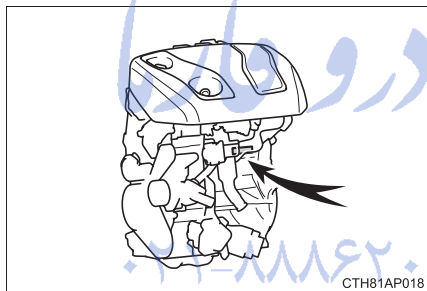

FarmaSOS.com

**Engine**

## ▶ Gasoline engine

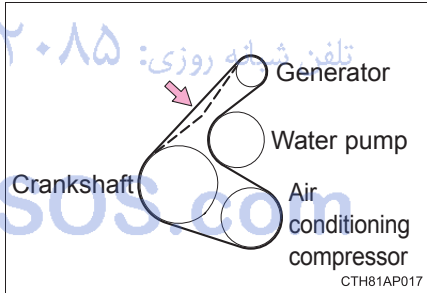
Model	1NR-FE, 1ZR-FAE
Type	4-cylinder in line, 4-cycle, gasoline
Bore and stroke	▶ 1NR-FE engine 72.5 × 80.5 mm (2.85 × 3.17 in.) ▶ 1ZR-FAE engine 80.5 × 78.5 mm (3.17 × 3.09 in.)
Displacement	▶ 1NR-FE engine 1329 cm <sup>3</sup> (81.1 cu.in.) ▶ 1ZR-FAE engine 1598 cm <sup>3</sup> (97.5 cu.in.)
Valve clearance	Automatic adjustment
Drive belt tension	▶ 1NR-FE engine Automatic adjustment ▶ 1ZR-FAE engine 7.6 — 10.0 mm (0.30 — 0.39 in.)*  *: Drive belt deflection with 98 N (10 kgf, 22 lbf) thumb force (used belt)

## ► Diesel engine

Model	1ND-TV
Type	4-cylinder in line, 4-cycle, diesel (with turbo-charger)
Bore and stroke	73 × 81.5 mm (2.87 × 3.21 in.)
Displacement	1364 cm <sup>3</sup> (83.2 cu.in.)
Valve clearance (engine cold)	Intake: 0.11 — 0.17 mm (0.004 — 0.007 in.) Exhaust: 0.14 — 0.20 mm (0.006 — 0.008 in.)
Drive belt tension	Automatic adjustment

## ⚠ NOTICE

## ■ Drive belt type (1ND-TV engine)

The high strength drive belt is used for the generator side drive belt. When replacing the drive belt, use Toyota genuine drive belt or equivalent high strength drive belt. If the high strength drive belt is not used, durability of the belt may become less than expected. The high strength drive belt is a belt with Aramid core which has higher strength compared to usually available belts with PET or PEN core.

تلفن شبانه روزی: ۰۲۱-۸۸۸۶۲۰۸۵

FarmaSOS.com



**Fuel**

## ► Gasoline engine

Fuel type	EU area: Unleaded gasoline conforming to European standard EN228 only Except EU area: Unleaded gasoline only
Research Octane Number	95 or higher
Fuel tank capacity (Reference)	55 L (14.5 gal., 12.1 Imp. gal.)

## ► Diesel engine

Fuel type	EU area: Diesel fuel conforming to European standard EN590 Except EU area: Diesel fuel that contains 50 ppm or less of sulfur
Cetane number	48 or higher
Fuel tank capacity (Reference)	55 L (14.5 gal., 12.1 Imp. gal.)

FarmaSOS.com

**Lubrication system**

Oil capacity (Drain and refill — reference*) With filter	<ul style="list-style-type: none"> <li>▶ 1NR-FE engine 3.4 L (3.6 qt., 3.0 Imp. qt.)</li> <li>▶ 1ZR-FAE engine 4.2 L (4.4 qt., 3.7 Imp. qt.)</li> <li>▶ 1ND-TV engine (for Turkey) 3.9 L (4.1 qt., 3.4 Imp. qt.)</li> <li>▶ 1ND-TV engine (except for Turkey) 3.7 L (3.9 qt., 3.3 Imp. qt.)</li> </ul>
Without filter	<ul style="list-style-type: none"> <li>▶ 1NR-FE engine 3.2 L (3.4 qt., 2.8 Imp. qt.)</li> <li>▶ 1ZR-FAE engine 3.9 L (4.1 qt., 3.4 Imp. qt.)</li> <li>▶ 1ND-TV engine (for Turkey) 3.5 L (3.7 qt., 3.1 Imp. qt.)</li> <li>▶ 1ND-TV engine (except for Turkey) 3.3 L (3.5 qt., 2.9 Imp. qt.)</li> </ul>

\*: The engine oil capacity is a reference quantity to be used when changing the engine oil. Warm up and turn off the engine, wait more than 5 minutes, and check the oil level on the dipstick.

**■ Engine oil selection**

## ▶ Gasoline engine

“Toyota Genuine Motor Oil” is used in your Toyota vehicle. Toyota recommends the use of approved “Toyota Genuine Motor Oil”. Another motor oil of matching quality can also be used.

Oil grade:

0W-20, 5W-30 and 10W-30:

API grade SL “Energy-Conserving”, SM “Energy-Conserving” or SN “Resource-Conserving”; or ILSAC multigrade engine oil

15W-40:

API grade SL, SM or SN multigrade engine oil

**Recommended viscosity (SAE):**

SAE 0W-20 is filled into your Toyota vehicle at manufacturing, and the best choice for good fuel economy and good starting in cold weather.

If SAE 0W-20 oil is not available, SAE 5W-30 oil may be used. However, it should be replaced with SAE 0W-20 at the next oil change.

If you use SAE 10W-30 or a higher viscosity engine oil in extremely low temperatures, the engine may become difficult to start, so SAE 0W-20 or 5W-30 engine oil is recommended.

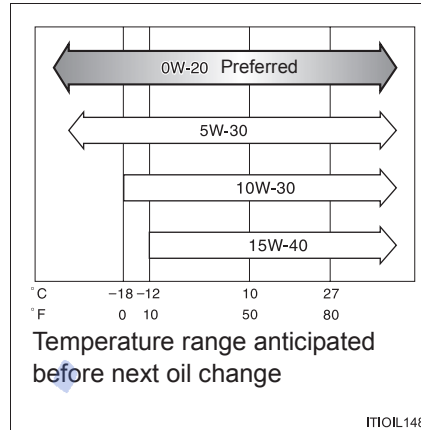
**Oil viscosity (0W-20 is explained here as an example):**

- The 0W in 0W-20 indicates the characteristic of the oil which allows cold startability. Oils with a lower value before the W allow for easier starting of the engine in cold weather.
- The 20 in 0W-20 indicates the viscosity characteristic of the oil when the oil is at high temperature. An oil with a higher viscosity (one with a higher value) may be better suited if the vehicle is operated at high speeds, or under extreme load conditions.

How to read oil container labels:

Either or both API registered marks are added to some oil containers to help you select the oil you should use.

① API Service Symbol

Top portion: "API SERVICE SN" means the oil quality designation by American Petroleum Institute (API).

Center portion: "SAE 0W-20" means the SAE viscosity grade.

Lower portion: "Resource-Conserving" means that the oil has fuel-saving and environmental protection capabilities.

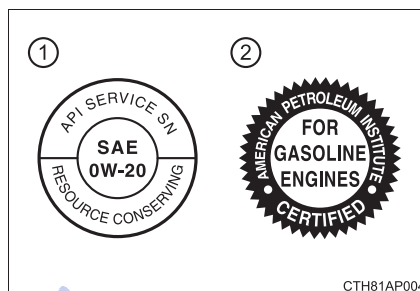

② ILSAC Certification Mark

The International Lubricant Specification Advisory Committee (ILSAC) Certification Mark is displayed on the front of the container.

تلفن شبانه روزی: ۰۲۱-۸۸۸۶۲۰۸۵

FarmaSOS.com

► Diesel engine

“Toyota Genuine Motor Oil” is used in your Toyota vehicle. Toyota recommends the use of approved “Toyota Genuine Motor Oil”. Another motor oil of matching quality can also be used

Oil grade: ACEA C2

 NOTICE

Using engine oil other than ACEA C2 may damage the catalytic converter.

Recommended viscosity (SAE):

SAE 0W-30 is filled into your Toyota vehicle at manufacturing, and the best choice for good fuel economy and good starting in cold weather.

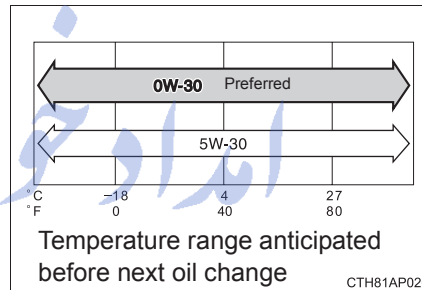

Oil viscosity (0W-30 is explained here as an example):

- The 0W in 0W-30 indicates the characteristic of the oil which allows cold startability. Oils with a lower value before the W allow for easier starting of the engine in cold weather.
- The 30 in 0W-30 indicates the viscosity characteristic of the oil when the oil is at high temperature. An oil with a higher viscosity (one with a higher value) may be better suited if the vehicle is operated at high speeds, or under extreme load conditions.

**Cooling system**

Capacity	1NR-FE engine	4.7 L (5.0 qt., 4.1 Imp. qt.)
	1ZR-FAE engine	▶ Vehicles with a Multidrive 5.8 L (6.1 qt., 5.1 Imp. qt.)
		▶ Vehicles with a manual transmission 5.6 L (5.9 qt., 4.9 Imp. qt.)
1ND-TV engine	▶ Without power heater 5.6 L (5.9 qt., 4.9 Imp. qt.)	
	▶ With power heater 6.0 L (6.3 qt., 5.3 Imp. qt.)	
Coolant type	Use either of the following. <ul style="list-style-type: none"> <li>• “Toyota Super Long Life Coolant”</li> <li>• Similar high-quality ethylene glycol-based non-silicate, non-amine, non-nitrite, and non-borate coolant with long-life hybrid organic acid technology</li> </ul> Do not use plain water alone.	

**Ignition system (gasoline engine)**

Spark plug	تلفن شبانه روزی: ۰۸۵-۸۸۶۲۰۸۵-۲۱	
Make	▶ 1NR-FE engine	DENSO SC16HR11
	▶ 1ZR-FAE engine	DENSO SC20HR11 DENSO SC16HR11
Gap	1.1 mm (0.043 in.)	

 NOTICE**■ Iridium-tipped spark plugs**

Use only iridium-tipped spark plugs. Do not adjust the spark plug gap.

**Electrical system**

Battery	
Open voltage at 20°C (68°F):	12.3 V or more If the voltage is lower than the standard value, charge the battery. (Voltage is checked 20 minutes after the engine and all lights are turned off.)
Charging rates	5 A max.

**Multidrive**

Fluid capacity*	7.5 L (7.9 qt., 6.6 Imp. qt.)
Fluid type	Toyota Genuine CVTF FE

\*: The fluid capacity is a reference quantity.  
If replacement is necessary, contact any authorized Toyota dealer or repairer, or another duly qualified and equipped professional.

 NOTICE

 **Multidrive fluid type**

Using Multidrive fluid other than “Toyota Genuine CVTF FE” may cause deterioration in shift quality, locking up of your transmission accompanied by vibration and, ultimately, damage to the vehicle’s transmission.

FarmaSOS.com

**Manual transaxle**

Gear oil capacity (Reference)	2.4 L (2.5 qt., 2.1 Imp. qt.)
Gear oil type	"TOYOTA Genuine Manual Transmission Gear Oil LV GL-4 75W" or equivalent

 NOTICE**Manual transaxle gear oil**

- Be aware that depending on the particular characteristics of the gear oil used or the operating conditions, the idle sound, shift feeling and/or fuel efficiency may be different or affected, and damage to the transaxle may occur. Toyota recommends using "TOYOTA Genuine Manual Transmission Gear Oil LV GL-4 75W" to achieve optimal performance.
- Your Toyota vehicle is filled with "TOYOTA Genuine Manual Transmission Gear Oil LV GL-4 75W" at the factory. Use Toyota approved "TOYOTA Genuine Manual Transmission Gear Oil LV GL-4 75W" or an equivalent oil of matching quality that satisfies the above specifications. Please contact any authorized Toyota dealer or repairer, or another duly qualified and equipped professional for further details.

تلفن شبانه روزی: ۰۲۱-۸۸۸۶۲۰۸۵

FarmaSOS.com



**Clutch**

Pedal free play	5 — 15 mm (0.2 — 0.6 in.)
Fluid type	SAE J1703 or FMVSS No.116 DOT 3 or SAE J1704 or FMVSS No.116 DOT 4

**Brakes**

Pedal clearance* <sup>1</sup> Left-hand drive vehicles Right-hand drive vehicles	69 mm (2.71 in.) Min. 78 mm (3.07 in.) Min.
Pedal free play	1 — 6 mm (0.04 — 0.24 in.)
Parking brake lever travel* <sup>2</sup>	6 — 8 clicks
Fluid type	SAE J1704 or FMVSS No.116 DOT 4

\*1: Minimum pedal clearance when depressed with a force of 300 N (30.6 kgf, 67.4 lbf) while the engine is running

\*2: Parking brake lever travel when pulled up with a force of 200 N (20.4 kgf, 45.0 lbf)

تلفن شبانه روزی: ۰۲۱-۸۸۶۲۰۸۵

FarmaSOS.com

**Steering**

Free play	Less than 30 mm (1.2 in.)
-----------	---------------------------

**Tires and wheels**

## ► 15-inch tires

Tire size	195/65R15 91H		
Tire inflation pressure (Recommended cold tire inflation pressure)	Vehicle speed	Front wheel kPa (kgf/cm <sup>2</sup> or bar, psi)	Rear wheel kPa (kgf/cm <sup>2</sup> or bar, psi)
	More than 160 km/h (100 mph)	Type A*: 260 (2.6, 38) Type B*: 270 (2.7, 39)	Type A*: 260 (2.6, 38) Type B*: 270 (2.7, 39)
	160 km/h (100 mph) or less	Type A*: 230 (2.3, 33) Type B*: 240 (2.4, 35)	Type A*: 230 (2.3, 33) Type B*: 240 (2.4, 35)
Wheel size	15 × 6 J		
Wheel nut torque	103 N•m (10.5 kgf•m, 76 ft•lbf)		

\*: The tire inflation pressure is specified on the tire-loading information label.  
(→P. 473)

FarmaSOS.com

## ► 16-inch and 17-inch tires

Tire size	205/55R16 91V, 215/45R17 87W		
Tire inflation pressure (Recommended cold tire inflation pressure)	Vehicle speed	Front wheel kPa (kgf/cm <sup>2</sup> or bar, psi)	Rear wheel kPa (kgf/cm <sup>2</sup> or bar, psi)
	More than 160 km/h (100 mph)	260 (2.6, 38)	260 (2.6, 38)
	160 km/h (100 mph) or less	230 (2.3, 33)	230 (2.3, 33)
Wheel size	16 × 6 1/2 J (16-inch tires), 17 × 7 J (17-inch tires)		
Wheel nut torque	103 N•m (10.5 kgf•m, 76 ft•lbf)		

## ► Compact spare tire

Tire size	T125/70D17 98M
Tire inflation pressure (Recommended cold tire inflation pressure)	420 kPa (4.2 kgf/cm <sup>2</sup> or bar, 60 psi)
Wheel size	17 × 4 T
Wheel nut torque	103 N•m (10.5 kgf•m, 76 ft•lbf)

## ■ When towing a trailer

Add 20.0 kPa (0.2 kgf/cm<sup>2</sup> or bar, 3 psi) to the recommended tire inflation pressure and drive at speeds below 100 km/h (62 mph).

**Light bulbs**

	Light Bulbs	W	Type
Exterior	Headlights (bulb type)		
	Low beam	55	A
	High beam	60	B
	Front fog lights*	19	C
	Front turn signal lights	21	D
	Side turn signal lights	5	D
	Rear fog light (bulb type)	21	E
	Rear turn signal lights	21	D
	Stop/tail lights (bulb type)	21/5	E
	Tail lights (bulb type)	5	E
Interior	Back-up lights	16	E
	Licence plate lights	5	E
	Vanity lights*	5	F
	Front interior light/personal lights	8	E
	Rear interior light	8	F
	Trunk light	3.8	E

A: H11 halogen bulbs

B: HB3 halogen bulbs

C: H16 halogen bulbs

D: Wedge base bulbs (amber)

E: Wedge base bulbs (clear)

F: Double end bulbs

\*: If equipped

## Fuel information

### ▶ Gasoline engine

#### EU area:

You must only use unleaded gasoline conforming to European standard EN228.

Select unleaded gasoline with a Research Octane Number of 95 or higher for optimum engine performance.

#### Except EU area:

You must only use unleaded gasoline.

Select unleaded gasoline with a Research Octane Number of 95 or higher for optimum engine performance.

### ▶ Diesel engine

#### EU area:

You must only use diesel fuel conforming to European standard EN590.

#### Except EU area:

You must only use diesel fuel that contains 50 ppm or less of sulfur with a cetane number of 48 or higher.

### ■ Use of ethanol blended gasoline in a gasoline engine

Toyota allows the use of ethanol blended gasoline where the ethanol content is up to 10%. Make sure that the ethanol blended gasoline to be used has a Research Octane Number that follows the above.

### ■ If you plan to drive in foreign countries (diesel engine)

Low sulfur diesel fuel may not be available, so please check the availability with your distributor.

### ■ If your engine knocks

- Consult any authorized Toyota dealer or repairer, or another duly qualified and equipped professional.
- You may occasionally notice light knocking for a short time while accelerating or driving uphill. This is normal and there is no need for concern.

 NOTICE**■ Notice on fuel quality**

- Do not use improper fuels. If improper fuels are used, the engine will be damaged.
- Gasoline engine: Do not use leaded gasoline. Leaded gasoline will cause the three-way catalytic converter to lose its effectiveness and the emission control system to function improperly.
- Diesel engine: Do not use a fuel that contains more than 50 ppm of sulfur. Use of such a high sulfur fuel may damage the engine.
- Gasoline engine (EU area): Bioethanol fuel sold under names such as “E50” or “E85” and fuel containing a large amount of ethanol should not be used. The use of these fuels will damage the vehicle’s fuel system. In case of any doubt, ask any authorized Toyota dealer or repairer, or another duly qualified and equipped professional.
- Gasoline engine (except EU area): Bioethanol fuel sold under names such as “E50” or “E85” and fuel containing a large amount of ethanol should not be used. Your vehicle can use gasoline mixed with 10% max ethanol. The use of fuel with more than 10% ethanol content (E10) will damage the vehicle’s fuel system. You must ensure that refueling is carried out only from a source where fuel specification and quality can be guaranteed. In case of any doubt, ask any authorized Toyota dealer or repairer, or another duly qualified and equipped professional.
- Diesel engine (EU area): FAME (Fatty Acid Methyl Ester) fuel sold under names such as “B30” or “B100” and fuel containing a large amount of FAME should not be used. The use of these fuels will damage the vehicle’s fuel system. In case of any doubt, ask any authorized Toyota dealer or repairer, or another duly qualified and equipped professional.
- Diesel engine (except EU area): FAME (Fatty Acid Methyl Ester) fuel sold under names such as “B30” or “B100” and fuel containing a large amount of FAME should not be used. Your vehicle can use diesel mixed with 5% max biodiesel FAME (B5). The use of fuel with more than 5% FAME content (B5) will damage the vehicle’s fuel system. You must ensure that refueling is carried out only from a source where fuel specification and quality can be guaranteed. In case of any doubt, ask any authorized Toyota dealer or repairer, or another duly qualified and equipped professional.
- Gasoline engine: Do not use the methanol blended gasoline such as M15, M85, M100. The use of gasoline containing methanol may cause engine damage or failure.

## Customizable features

Your vehicle includes a variety of electronic features that can be personalized to your preferences. The settings of these features can be changed using the meter control switches, on the navigation/multimedia system screen or at any authorized Toyota dealer or repairer, or another duly qualified and equipped professional.

### Customizing vehicle features

#### ■ Changing on the navigation/multimedia system screen (vehicles with a navigation/multimedia system)

- 1 Press the "SETUP" button.
- 2 Touch "Vehicle" on the "Setup" screen.  
Select the desired item.

Various settings can be changed. Refer to the list of settings that can be changed for details.

#### ■ Changing using the meter control switches (vehicles with a multi-information display)

→P. 104

### Customizable features

Some function settings are changed simultaneously with other functions when customized. Contact any authorized Toyota dealer or repairer, or another duly qualified and equipped professional for further details.

- ① Settings that can be changed on the navigation/multimedia system screen (vehicles with a navigation/multimedia system)
- ② Settings that can be changed using the meter control switches (vehicles with a multi-information display)
- ③ Settings that can be changed by any authorized Toyota dealer or repairer, or another duly qualified and equipped professional

Definition of symbols: O = Available, — = Not available

**■ Gauges, meters and multi-information display\*1 (→P. 92, 101)**

Function*2	Default setting	Customized setting	①	②	③
Language*3	English	*4	—	○	—
Units*3	km (L/100 km)	km (km/L)	○	○	—
		miles (MPG)	○	○	—
	°C	°F	○	○	—
Eco Driving Indicator Light*5	On (Self-lighting)	Off	—	○	—
Drive information 1	Current fuel consumption (gauge display)	*6	—	○	—
	Average fuel economy (after reset)				
Drive information 2	Distance (driving range)	*6	—	○	—
	Average vehicle speed (after reset)				
Drive information 3*5	Stop & Start system operation time (after start)	*6	—	○	—
	Stop & Start system operation time (after reset)				
Pop-up display*5	On	Off	—	○	—



- \*1: Vehicles with a multi-information display
- \*2: For details about each function: →P. 107
- \*3: The default setting varies according to country.
- \*4: German, French, Spanish, Italian, Portuguese, Dutch, Swedish, Norwegian, Danish, Russian, Finnish, Greek, Polish, Ukrainian, Turkish, Hungarian, Czech, Slovak, Romanian
- \*5: If equipped
- \*6: 2 of the following items: current fuel consumption (gauge display), current fuel consumption (numerical display), average fuel economy (after reset), average fuel economy (after start), average fuel economy (after refuel), Stop & Start system operation time (after reset)<sup>\*5</sup>, Stop & Start system operation time (after start)<sup>\*5</sup>, average vehicle speed (after reset), average vehicle speed (after start), elapsed time (after reset), elapsed time (after start), distance (driving range), distance (after start), blank.

■ **Smart entry & start system\* and wireless remote control**  
(→P. 127, 133, 138)

Function	Default setting	Customized setting	①	②	③
Operation signal (Emergency flashers)	On	Off	○	—	○
Time elapsed before automatic door lock function is activated if door is not opened after being unlocked	30 seconds	60 seconds			
		120 seconds	—	—	○
Open door warning buzzer*	On	Off	—	—	○

\*: If equipped

### ■ Smart entry & start system\* (→P. 127, 133, 138)

Function	Default setting	Customized setting	①	②	③
Smart entry & start system	On	Off	○	—	○
Number of consecutive door lock operations	2 times	As many as desired	—	—	○

\*: If equipped

### ■ Wireless remote control (→P. 116, 127, 133)

Function	Default setting	Customized setting	①	②	③
Wireless remote control	On	Off	—	—	○
Unlocking function	All the doors and trunk	All the doors	—	—	○
Trunk unlocking operation*	Press and hold (short)	One short press	—	—	○
		Push twice			
		Press and hold (long)			
		Off			

\*: If equipped

### ■ Turn signal lever (→P. 222)

Function	Default setting	Customized setting	①	②	③
The number of times the turn signal lights flash automatically when the turn signal lever is moved to the first position during a lane change	3	5	—	—	○
		7			
		Off			

### ■ Automatic light control system\* (→P. 224)

Function	Default setting	Customized setting	①	②	③
Adjust the sensitivity of the ambient light sensor	Level 3	Levels 1 to 5	0	—	0

\*: If equipped

### ■ Follow me home system (→P. 226)

Function	Default setting	Customized setting	①	②	③
Time elapsed before headlights automatically turn off	30 seconds	60 seconds			
		90 seconds	—	—	0
		120 seconds			

### ■ LDA (Lane Departure Alert)\* (→P. 259)

Function	Default setting	Customized setting	①	②	③
LDA warning sensitivity	High	Standard	—	0	—

\*: If equipped

### ■ RSA (Road Sign Assist)\* (→P. 268)

Function	Default setting	Customized setting	①	②	③
RSA system	On	Off	—	0	—
Notification method of excessive speed	Only display	Display and buzzer		0	
		Off			
Notification methods other than excessive speed	Only display	Display and buzzer		0	
		Off			
Notification level of excessive speed	2 km/h (1 mph)	10 km/h (5 mph)		0	
		5 km/h (3 mph)			

\*: If equipped

### ■ Stop & Start system\* (→P. 274)

Function	Default setting	Customized setting	①	②	③
Change the Stop & Start system duration when the A/C is on	Normal	Long	—	○	—

\*: If equipped

### ■ Toyota parking assist-sensor\* (→P. 293)

Function	Default setting	Customized setting	①	②	③
Toyota parking assist-sensor system	On	Off	—	○	—

\*: If equipped

### ■ Automatic air conditioning system\* (→P. 399)

Function	Default setting	Customized setting	①	②	③
Switching between outside air and recirculated air mode linked to "AUTO" switch operation	On	Off	○	—	○
A/C auto switch operation	On	Off	—	—	○

\*: If equipped

### ■ Illumination (→P. 413)

Function	Default setting	Customized setting	①	②	③
Interior light illumination control*	On	Off	O	—	O
Time elapsed before the interior lights turn off	15 seconds	7.5 seconds	O*	—	O
		30 seconds			
Operation after the engine switch is turned off	On	Off	—	—	O
Operation when the doors are unlocked	On	Off	—	—	O
Operation when you approach the vehicle with the electronic key on your person*	On	Off	—	—	O

\*: If equipped

### ■ Vehicle customization

When the doors remain closed after unlocking the doors and the timer activated automatic door lock function activates, signals will be generated in accordance with the operational signal (emergency flashers) function setting.

#### ⚠ WARNING

#### ■ During customization

As the engine needs to be running during customization, ensure that the vehicle is parked in a place with adequate ventilation. In a closed area such as a garage, exhaust gases including harmful carbon monoxide (CO) may collect and enter the vehicle. This may lead to death or a serious health hazard.

#### ⚠ NOTICE

#### ■ During customization

To prevent battery discharge, ensure that the engine is running while customizing features.

## Items to initialize

The following item must be initialized for normal system operation after such cases as the 12-volt battery being reconnected, or maintenance being performed on the vehicle:

Item	When to initialize	Reference
Engine oil maintenance data*	After changing the engine oil	P. 450
Tire pressure warning system*	<ul style="list-style-type: none"> <li>• When changing the tire size</li> <li>• When changing the tire inflation pressure by changing traveling speed or load weight, etc.</li> </ul>	P. 462

\*: If equipped

امداد خودرو فارما  
تلفن شبانه روزی: ۰۲۱-۸۸۸۶۲۰۸۵

FarmaSOS.com

## Index

What to do if... (Troubleshooting).....	620
Alphabetical index.....	626

امداد خودرو فارما

تلفن شبانه روزی: ۰۲۱-۸۸۸۶۲۰۸۵

FarmaSOS.com

## What to do if... (Troubleshooting)

**If you have a problem, check the following before contacting any authorized Toyota dealer or repairer, or another duly qualified and equipped professional.**

### The doors cannot be locked, unlocked, opened or closed



#### You lose your keys

- If you lose your keys or mechanical keys, new genuine keys or mechanical keys can be made by any authorized Toyota dealer or repairer, or another duly qualified and equipped professional. (→P. 118)
- If you lose your keys or electronic keys, the risk of vehicle theft increases significantly. Contact any authorized Toyota dealer or repairer, or another duly qualified and equipped professional immediately. (→P. 126)



#### The doors cannot be locked or unlocked

- Is the key battery weak or depleted? (→P. 480)
- Vehicles with a smart entry & start system:  
Is the engine switch in IGNITION ON mode?  
When locking the doors, turn the engine switch off. (→P. 202)
- Vehicles with a smart entry & start system:  
Is the electronic key left inside the vehicle?  
When locking the doors, make sure that you have the electronic key on your person.
- The function may not operate properly due to the condition of the radio wave. (→P. 132, 142)



**The rear door cannot be opened**

- Is the child-protector lock set?  
The rear door cannot be opened from inside the vehicle when the lock is set. Open the rear door from outside and then unlock the child-protector lock. (→P. 131)

**The trunk lid is closed with the electronic key left inside (vehicles with a smart entry & start system)**

- The function to prevent the electronic key from being left inside the trunk will operate and you can open the trunk as usual. Take the key out from the trunk. (→P. 133)

**If you think something is wrong****The engine does not start (vehicles without a smart entry & start system)**

- Vehicles with a manual transmission:  
Do you turn the key with the clutch pedal depressed firmly? (→P. 196)
- Vehicles with a Multidrive:  
Is the shift lever in P? (→P. 196)
- Is the steering wheel unlocked? (→P. 197)
- Is the battery discharged? (→P. 578)

FarmaSOS.com



### The engine does not start (vehicles with a smart entry & start system)

- Except vehicles with a manual transmission:  
Did you press the engine switch while firmly depressing the brake pedal?  
(→P. 199)
- Vehicles with a manual transmission:  
Did you press the engine switch while firmly depressing the clutch pedal?  
(→P. 199)
- Vehicles with a Multidrive:  
Is the shift lever in P? (→P. 205)
- Is the electronic key anywhere detectable inside the vehicle? (→P. 139)
- Is the steering wheel unlocked? (→P. 206)
- Is the electronic key battery weak or depleted?  
In this case, the engine can be started in a temporary way. (→P. 576)
- Is the battery discharged? (→P. 578)



### The shift lever cannot be shifted from P even if you depress the brake pedal (vehicles with a Multidrive)

- Vehicles without a smart entry & start system: *تلفن شبانه روزی: ۰۲۱-۸۸۶۲۸۸۰۰*  
Is the engine switch in the "ON" position?  
If you cannot release the shift lever by depressing the brake pedal with the engine switch in the "ON" position. (→P. 573)
- Vehicles with a smart entry & start system: *www.iran48.com*  
Is the engine switch in IGNITION ON mode?  
If you cannot release the shift lever by depressing the brake pedal with the engine switch in IGNITION ON mode. (→P. 573)

**The steering wheel cannot be turned after the engine is stopped**

- Vehicles without a smart entry & start system:  
It is locked to prevent theft of the vehicle if the key is pulled from the engine switch. (→P. 197)
- Vehicles with a smart entry & start system:  
It is locked automatically to prevent theft of the vehicle. (→P. 205)

**The windows do not open or close by operating the power window switches**

- Is the window lock switch pressed?  
The power window except for the one at the driver's seat cannot be operated if the window lock switch is pressed. (→P. 169)

**The engine switch is turned off automatically (vehicles with a smart entry & start system)**

- The auto power off function will be operated if the vehicle is left in ACCESSORY or IGNITION ON mode (the engine is not running) for a period of time. (→P. 205)

تلفن شبانه روزی: ۰۲۱-۸۸۶۲۰۸۵

FarmaSOS.com



**A warning buzzer sounds during driving**

- The seat belt reminder light is flashing  
Are the driver and the front passenger wearing the seat belts? (→P. 517)
  - The brake system warning light is on  
Is the parking brake released? (→P. 223)
- Depending on the situation, other types of warning buzzer may also sound. (→P. 513, 526)



**A warning buzzer sounds when leaving the vehicle  
(vehicles with a smart entry & start system)**

- Is the electronic key left inside the vehicle?  
Vehicles with a multi-information display: Check the message on the multi-information display. (→P. 526)



**A warning light turns on  
(vehicles with a drive monitor display)**

- When a warning light turns on, refer to P. 513.



**A warning light turns on or a warning message or indicator is displayed (vehicles with a multi-information display)**

- When a warning light turns on or a warning message or indicator is displayed, refer to P. 513, 526.

FarmaSOS.com

**When a problem has occurred****If you have a flat tire**

- Vehicles with an emergency tire puncture repair kit:  
Stop the vehicle in a safe place and repair the flat tire temporarily with the emergency tire puncture repair kit. (→P. 532)
- Vehicles with a spare tire:  
Stop the vehicle in a safe place and replace the flat tire with the spare tire. (→P. 555)

**The vehicle becomes stuck**

- Try the procedure for when the vehicle becomes stuck in mud, dirt, or snow. (→P. 588)

تلفن شبانه روزی: ۰۲۱-۸۸۸۶۲۰۸۵

FarmaSOS.com

## Alphabetical index

### A

- A/C**..... 392, 399  
 Air conditioning filter..... 478
- ABS**  
**(Anti-lock Brake System)**..... 314  
 Function ..... 314  
 Warning light..... 515
- Air conditioning filter** ..... 478
- Air conditioning system** ..... 392, 399  
 Air conditioning filter..... 478
- Airbag manual on-off system** ..... 55
- Airbags** ..... 43  
 Airbag manual on-off system ..... 55  
 Airbag operating conditions ..... 50  
 Airbag precautions for your child ..... 45  
 Airbag warning light ..... 514  
 Correct driving posture..... 36  
 Curtain shield airbag operating conditions ..... 50  
 Curtain shield airbag precautions ..... 47  
 General airbag precautions..... 45  
 Locations of airbags ..... 43  
 Modification and disposal of airbags..... 49  
 Side airbag operating conditions ..... 50  
 Side airbag precautions ..... 45  
 Side and curtain shield airbags operating conditions ..... 50  
 Side and curtain shield airbags precautions ..... 45  
 SRS airbags..... 43
- Anchor brackets** ..... 67
- Antennas (smart entry & start system)** ..... 138
- Anti-lock Brake System (ABS)** ..... 314  
 Function ..... 314  
 Warning light..... 515
- Armrest**..... 425
- Assist grips** ..... 426
- Audio input** ..... 361
- Audio system** ..... 328  
 Antenna ..... 337  
 Audio input..... 361  
 AUX port/USB port ..... 331  
 Bluetooth® audio..... 362  
 CD player..... 338  
 iPod..... 346  
 MP3/WMA disc ..... 338  
 Optimal use..... 332  
 Portable music player ..... 361  
 Radio ..... 334  
 Steering wheel audio switch ..... 330  
 USB memory ..... 354
- Audio visual input** ..... 361
- Automatic light control system**..... 225
- AUX port**..... 361
- Auxiliary boxes** ..... 420

**B**

<b>Back-up lights</b>	
Replacing light bulb.....	496
Wattage.....	608
<b>Battery</b> .....	<b>454</b>
Checking .....	454
If the vehicle has discharged battery.....	578
Preparing and checking before winter.....	323
Warning light.....	513
<b>Bluetooth®</b>	
Audio system .....	379
Hands-free system (for cellular phone).....	382
<b>Bottle holders</b> .....	<b>418</b>
<b>Brake</b>	
Fluid .....	605
Parking brake.....	223
Warning light.....	513
<b>Brake assist</b> .....	<b>314</b>
<b>Break-in tips</b> .....	<b>178</b>
<b>Brightness control</b>	
Meter light control .....	97, 107

**C**

<b>Care</b> .....	<b>428, 432</b>
Aluminum wheels.....	429
Exterior .....	428
Interior.....	432
Seat belts.....	433
<b>CD player</b> .....	<b>338</b>
<b>Chains</b> .....	<b>324</b>
<b>Child restraint system</b> .....	<b>58</b>
Baby seats, definition.....	59
Baby seats, installation .....	68
Child seats, definition.....	59
Child seats, installation .....	68
Installing CRS with ISOFIX rigid anchors.....	71
Installing CRS with seat belts .....	68
Installing CRS with top strap...	72
Junior seats, definition .....	59
Junior seats, installation .....	70

FarmaSOS.com

**Child safety ..... 57**  
 Airbag precautions ..... 45  
 Battery precautions ..... 456, 583  
 Child restraint system ..... 58  
 How your child should wear  
     the seat belt ..... 40  
 Installing child restraints ..... 67  
 Power window lock switch ... 169  
 Power window precautions ... 172  
 Rear door child-protectors ... 131  
 Removed electronic key  
     battery precautions ..... 482  
 Seat belt precautions ..... 42  
 Seat heater precautions ..... 411  
 Trunk precautions ..... 136  
**Child-protectors ..... 131**  
**Cleaning ..... 428, 432**  
     Aluminum wheels ..... 429  
     Exterior ..... 428  
     Interior ..... 432  
     Seat belts ..... 433  
**Clock ..... 423**  
**Coat hook ..... 425**  
**Condenser ..... 453**  
**Console box ..... 417**  
**Cooling system**  
     Engine overheating ..... 584  
**Cruise control ..... 286**  
**Cup holders ..... 419**  
**Curtain shield airbags ..... 43**  
**Customizable features ..... 611**

**D**

**Daytime running light system ..... 227**  
**Defogger**  
     Outside rear view mirrors ..... 394, 403  
     Rear window ..... 394, 403  
**Dimensions ..... 592**  
**Display**  
     Drive monitor display ..... 92  
     Multi-information display ..... 101  
     Trip information ..... 96, 103  
     Warning message ..... 526  
**Do-it-yourself maintenance .... 438**  
**Door lock**  
     Doors ..... 127  
     Smart entry & start system ... 138  
     Wireless remote control ..... 127, 134  
**Doors ..... 127**  
     Door lock ..... 127  
     Door windows ..... 169  
     Open door warning buzzer ... 139  
     Open door warning light ..... 517  
     Outside rear view mirrors ..... 166  
     Rear door child-protector ..... 131  
**DPF**  
     Diesel Particulate Filter system ..... 313  
     Warning light ..... 518  
**Driving ..... 174**  
     Break-in tips ..... 178  
     Correct posture ..... 36  
     Procedures ..... 174  
     Winter drive tips ..... 323



## E

- Eco Driving**  
**Indicator** ..... 99, 109
- Electric Power Steering (EPS)** ..... 314  
 Function ..... 314  
 Warning light ..... 515
- Electronic key** ..... 116  
 Battery-saving function ..... 141  
 If the electronic key does not operate properly ..... 575  
 Replacing the battery ..... 480
- Emergency, in case of**  
 If a warning message or indicator is displayed ..... 526  
 If the battery is discharged ..... 578  
 If the electronic key does not operate properly ..... 575  
 If the engine will not start ..... 571  
 If the shift lever cannot be shifted ..... 574  
 If the shift lever cannot be shifted from P ..... 573  
 If the warning buzzer sounds ..... 513  
 If the warning light turns on ..... 513  
 If you have a flat tire ..... 532, 555  
 If you think something is wrong ..... 511  
 If your vehicle becomes stuck ..... 588  
 If your vehicle has to be stopped in an emergency ... 503  
 If your vehicle needs to be towed ..... 505  
 If your vehicle overheats ..... 584
- Emergency brake signal** ..... 315
- Emergency flashers** ..... 502
- Emergency tire puncture repair kit** ..... 532
- Engine** ..... 595  
 Compartment ..... 444  
 Engine switch ..... 196, 199  
 Hood ..... 441  
 How to start the engine ..... 196, 199  
 Identification number ..... 594  
 If the engine will not start ..... 571  
 Ignition switch (engine switch) ..... 196, 199  
 Overheating ..... 584
- Engine coolant** ..... 452  
 Capacity ..... 602  
 Checking ..... 452  
 Preparing and checking before winter ..... 323
- Engine coolant temperature gauge** ..... 101
- Engine immobilizer system** ..... 77
- Engine oil** ..... 447  
 Capacity ..... 598  
 Checking ..... 447  
 Oil level warning light ..... 517  
 Oil pressure warning light ..... 513  
 Preparing and checking before winter ..... 323
- Engine switch** ..... 196, 199
- EPS (Electric Power Steering)** ..... 314  
 Function ..... 314  
 Warning light ..... 515

**F**

**Flat tire**

- Vehicles with a spare tire ..... 555
- Vehicles with an emergency  
tire puncture repair kit ..... 532

**Floor mats ..... 34**

**Fluid**

- Brake ..... 605
- Multidrive ..... 603
- Washer ..... 457

**Fog lights ..... 230**

- Replacing light bulbs ..... 488
- Switch ..... 230
- Wattage ..... 608

**Follow me home system ..... 226**

**Front fog lights ..... 230**

- Replacing light bulbs ..... 492
- Switch ..... 230
- Wattage ..... 608

**Front interior light ..... 414**

**Front position lights ..... 224**

- Light switch ..... 224
- Replacing light bulbs ..... 500

**Front seats ..... 155**

- Adjustment ..... 155
- Cleaning ..... 432
- Correct driving posture ..... 36
- Head restraints ..... 159
- Seat heaters ..... 411

**Front turn signal lights ..... 222**

- Replacing light bulbs ..... 494
- Turn signal lever ..... 222
- Wattage ..... 608

**Fuel ..... 237**

- Capacity ..... 597
- Fuel gauge ..... 92
- Fuel pump shut off system ..... 512
- Information ..... 609
- Refueling ..... 237
- Type ..... 597, 609
- Warning light ..... 517

**Fuel door ..... 237**

**Fuel filler door ..... 237**

**Fuel filter ..... 458**

**Fuel pump shut off system ..... 512**

**Fuses ..... 483**

**G**

**Gauges ..... 92, 101**

**Gear Shift Indicator ..... 215, 219**

**Glove box ..... 417**

**H**

- Hands-free system**
- (for cellular phone)**..... 382
- Head restraints**..... 159
- Headlights** ..... 224
  - Follow me home system ..... 226
  - Light switch ..... 224
  - Replacing light bulbs..... 490, 491
  - Wattage..... 608
- Heaters**
  - Outside rear view mirrors ..... 394, 403
  - Seat heaters..... 411
- Hill-start assist control**..... 314, 321
- Hood**..... 441
- Hooks**
  - Coat hook..... 425
  - Grocery bag hook ..... 422
  - Retaining hooks (floor mat)..... 34
- Horn** ..... 161

**I**

- Identification** ..... 593
  - Engine..... 594
  - Vehicle..... 593
- Ignition switch**
  - (engine switch)** ..... 196, 199
- Illuminated entry system**..... 415
- Immobilizer system** ..... 77
- Indicators**..... 89
- Initialization**
  - Power windows ..... 171
  - Tire pressure warning system..... 461
- Inside rear view mirror** ..... 163
- Intercooler** ..... 453
- Interior lights**..... 413
- ISOFIX rigid anchors** ..... 67

**J**

- Jack**
  - Positioning the jack..... 443
  - Vehicle-equipped jack... 534, 556
- Jack handle**..... 534, 556
- Jam protection function**
  - Power window..... 170

**K**

- Keyless entry** ..... 138
  - Smart entry & start system ... 138
  - Wireless remote control..... 127, 134
- Keys**..... 116
  - Battery-saving function ..... 141
  - Electronic key ..... 116
  - Engine switch..... 196, 199
  - If the electronic key does not operate properly ..... 575
  - Key number plate..... 116
  - Keyless entry ..... 127, 133
  - Mechanical key ..... 118
  - Replacing the battery ..... 480
  - Warning buzzer..... 139
  - Wireless remote control key ..... 117
- Knee airbags**..... 43

**L**

**Lever**  
 Auxiliary catch lever ..... 441  
 Hood lock release lever ..... 441  
 Shift lever ..... 209, 213, 218  
 Turn signal lever ..... 222  
 Wiper lever ..... 232

**License plate lights ..... 224**  
 Light switch ..... 224  
 Replacing light bulbs ..... 497  
 Wattage ..... 608

**Light bulbs**  
 Replacing ..... 488  
 Wattage ..... 608

**Lights**  
 Fog light switch ..... 230  
 Follow me home system ..... 226  
 Front interior light ..... 414  
 Headlight switch ..... 224  
 Illuminated entry system ..... 415  
 Interior lights list ..... 413  
 Personal lights ..... 414  
 Rear interior light ..... 415  
 Replacing light bulbs ..... 490  
 Trunk light ..... 135  
 Turn signal lever ..... 222  
 Vanity lights ..... 414  
 Wattage ..... 608

**Lock steering column ..... 197, 206**

**M**

**Maintenance**  
 Do-it-yourself maintenance ... 438  
 Maintenance data ..... 592  
 Maintenance requirements ... 435

**Malfunction indicator lamp ..... 514**

**Manual air conditioning system ..... 392**

**Manual headlight leveling dial ..... 227**

**Manual transmission**  
 Gear Shift Indicator ..... 219  
 Manual transmission ..... 218

**Master warning light ..... 518**

**Meter ..... 92, 101**  
 Indicators ..... 89  
 Meter light control ..... 97, 107  
 Meters ..... 92, 101  
 Multi-information display ..... 101  
 Warning lights ..... 87

**Meter light control ..... 97, 107**

**Mirrors**  
 Inside rear view mirror ..... 163  
 Outside rear view mirror defoggers ..... 394, 403  
 Outside rear view mirrors ..... 166  
 Vanity mirrors ..... 423

<b>MP3 disc</b> .....	<b>338</b>
<b>Multi-information display</b> .....	<b>101</b>
Drive information .....	105
Language .....	108
LDA (Lane Departure Alert) .....	261
PCS (Pre-Crash Safety system) .....	246, 249
RSA (Road Sign Assist) .....	269
Settings .....	107
Stop & Start system .....	281
Warning message .....	526
<b>Multi-mode manual transmission</b>	
Easy (E) mode .....	215
Easy sports (Es) mode .....	214
If the shift lever cannot be shifted .....	574
Manual (M) mode .....	214
Multi-mode manual transmission .....	213
<b>Multidrive</b> .....	<b>209</b>
If the shift lever cannot be shifted from P .....	573
Manual (M) mode .....	211
Sport mode .....	210

## O

<b>Odometer</b> .....	<b>96, 103</b>
<b>Oil</b>	
Engine oil .....	598
<b>Opener</b>	
Hood .....	441
Trunk .....	133
<b>Outside rear view mirrors</b> .....	<b>166</b>
Adjusting and folding .....	166
Outside rear view mirror defoggers .....	394, 403
<b>Outside temperature display</b> .....	<b>92</b>
<b>Overheating, Engine</b> .....	<b>584</b>

## P

<b>Paddle shift switches</b> .....	<b>214, 215</b>
<b>Parking assist sensors</b> .....	<b>293</b>
<b>Parking brake</b> .....	<b>223</b>
Operation .....	223
Parking brake engaged warning buzzer .....	223, 513
<b>Personal lights</b> .....	<b>414</b>
<b>Power heater</b> .....	<b>409</b>
<b>Power outlets</b> .....	<b>424</b>
<b>Power steering</b> .....	<b>314</b>
Warning light .....	515
<b>Power windows</b> .....	<b>169</b>
Jam protection function .....	170
Operation .....	169
Window lock switch .....	169

**R**

**Radiator** ..... 453  
**Radio** ..... 334  
**Radio Data System (RDS)** ..... 336  
**Rear fog light**..... 230  
     Replacing light bulb..... 496  
     Switch ..... 230  
     Wattage..... 608  
**Rear interior light**..... 414  
**Rear seat**  
     Folding down..... 156  
**Rear turn signal lights** ..... 222  
     Replacing light bulbs ..... 495  
     Turn signal lever ..... 222  
     Wattage..... 608  
**Rear view mirror**  
     Inside rear view mirror ..... 163  
     Outside rear view mirrors..... 166  
**Rear view monitor system\***  
**Rear window**  
     defogger ..... 394, 403  
**Refueling** ..... 237  
     Capacity ..... 597  
     Fuel types ..... 597, 609  
     Opening the fuel tank cap ..... 239  
**Replacing**  
     Electronic key battery..... 480  
     Fuses ..... 483  
     Light bulbs..... 488  
     Tires ..... 555

**S**

**Seat belt reminder light**..... 517  
**Seat belts**..... 38  
     Adjusting the seat belt ..... 39  
     Child restraint system  
         installation ..... 68  
     Cleaning and maintaining  
         the seat belt..... 433  
     Emergency Locking Retractor  
         (ELR) ..... 40  
     How to wear your seat belt ..... 38  
     How your child should wear  
         the seat belt..... 40  
     Pregnant women, proper  
         seat belt use ..... 41  
     Reminder light and buzzer... 517  
     Seat belt pretensioners..... 39  
     SRS warning light ..... 514  
**Seat heaters** ..... 411  
**Seats** ..... 155  
     Adjustment..... 155  
     Adjustment precautions ..... 155  
     Child seats/child restraint  
         system installation ..... 67  
     Cleaning..... 432  
     Head restraints ..... 159  
     Properly sitting in the seat ..... 36  
     Seat heaters ..... 411

- Sensor**
- Automatic headlight system ..... 227
  - Inside rear view mirror ..... 164
  - Rain-sensing windshield wipers ..... 235
  - Toyota parking assist-sensor ..... 293
- Shift lever ..... 209, 213, 218**
- If the shift lever cannot be shifted ..... 574
  - If the shift lever cannot be shifted from P ..... 573
  - Manual transmission ..... 218
  - Multidrive ..... 209
  - Multi-mode manual transmission ..... 213
- Shift lock system ..... 573, 574**
- Side airbags ..... 43**
- Side mirrors ..... 166**
- Adjusting and folding ..... 166
- Side turn signal lights ..... 222**
- Replacing light bulbs ..... 498
  - Turn signal lever ..... 222
  - Wattage ..... 608
- Simple IPA ..... 299**
- Smart entry & start system ..... 138**
- Antenna location ..... 138
  - Entry functions ..... 127, 133
  - Starting the engine ..... 199
- Snow tires ..... 325**
- Spare tire ..... 555**
- Inflation pressure ..... 606
  - Storage location ..... 556
- Spark plug ..... 602**
- Specifications ..... 592**
- Speech command system\***
- Speed limiter ..... 290**
- Speedometer ..... 92, 101**
- Sport mode ..... 210**
- Steering lock**
- Column lock release ..... 197, 206
- Steering wheel ..... 161**
- Adjustment ..... 161
  - Audio switches ..... 330
- Stop & Start cancel switch ..... 275**
- Stop & Start system ..... 274**
- Stop lights**
- Emergency brake signal ..... 315
  - Replacing light bulbs ..... 495
- Storage feature ..... 416**
- Stuck**
- If the vehicle becomes stuck ..... 588
- Sun visors ..... 423**

\*: Refer to "Navigation and multimedia system Owner's manual"

**Switches**

Airbag manual on-off switch.....	55	Paddle shift switches ....	214, 215
Audio remote control switches.....	330	Power door lock switch .....	130
Cruise control switch .....	286	Power heater switch .....	409
“DISP” switch .....	96	Power window switches.....	169
Door lock switches .....	130	Rear window and outside rear view mirror defoggers switch .....	394, 403
Emergency flashers switch ...	502	Seat heater switches .....	411
Engine switch.....	196, 199	“SPORT” switch .....	210
“Es” switch .....	214	Stop & Start cancel switch ...	274
Fog light switch .....	230	Telephone switches*.....	367
Ignition switch .....	196, 199	Tire pressure warning reset switch .....	462
Light switches .....	224	Toyota parking assist-sensor switch .....	294
Outside rear view mirror switches.....	166	“TRIP” switch .....	103
		Trunk opener switch .....	134
		VSC OFF switch .....	315
		Window lock switch.....	169
		Windshield wiper and washer switch.....	232
		Windshield wiper de-icer switch .....	395, 404

FarmaSOS.com



## T

<b>Tachometer</b> .....	92, 101
<b>Tail lights</b> .....	224
Light switch .....	224
Replacing light bulbs .....	495
Wattage .....	608
<b>Telephone switches*</b> .....	367
<b>Theft deterrent system</b>	
Engine immobilizer system .....	77
<b>Tire inflation pressure</b> .....	473
Maintenance data .....	606
<b>Tire pressure warning system</b> .....	461
Function .....	461
Initializing .....	462
Installing tire pressure warning valves and transmitters .....	461
Registering ID codes .....	463
Tire pressure warning reset switch .....	462
Warning light .....	519

<b>Tires</b> .....	460
Chains .....	324
Checking .....	460
Emergency tire puncture repair kit .....	532
If you have a flat tire .....	532, 555
Inflation pressure .....	606
Replacing .....	555
Rotating tires .....	461
Size .....	606
Snow tires .....	325
Spare tire .....	555
Tire pressure warning system .....	461
Warning light .....	519
<b>Tools</b> .....	534, 556
<b>Top strap</b> .....	72
<b>Towing</b> .....	505
Emergency towing .....	505
Towing capacity .....	592
Towing eyelet .....	507
Trailer towing .....	188
<b>Toyota parking assist-sensor</b> .....	293
Function .....	293

\*: For vehicles with navigation/multimedia system, refer to the "Navigation and multimedia system Owner's manual"

**Traction Control (TRC)** ..... 314  
**Trailer towing** ..... 188  
**Transmission** ..... 209, 213, 218  
**TRC (Traction Control)** ..... 314  
**Trip information** ..... 96, 103  
**Trip meters** ..... 96, 103  
**Trunk** ..... 133  
     Smart entry & start  
         system ..... 133  
     Trunk features ..... 422  
     Trunk handle ..... 135  
     Trunk light ..... 135  
     Trunk opener ..... 133  
     Wireless remote control ..... 134  
**Trunk light**  
     Trunk light ..... 135  
     Wattage ..... 608  
**Turn signal lights** ..... 222  
     Replacing light bulbs ..... 494, 495  
     Turn signal lever ..... 222  
     Wattage ..... 608

**U**

**USB port** ..... 331

**V**

**Vanity lights** ..... 423  
     Wattage ..... 608  
**Vanity mirrors** ..... 423  
**Vehicle identification  
 number** ..... 593  
**Vehicle Stability Control  
 (VSC)** ..... 314  
**VSC (Vehicle Stability  
 Control)** ..... 314

تلفن شبانه روزی: ۰۲۱-۸۸۶۲۰۸۵

FarmaSOS.com

## W

- Warning buzzers** ..... 513
- Brake system ..... 513
  - Clutch ..... 514
  - Downshifting ..... 212, 216
  - Key reminder ..... 197
  - Open door ..... 517
  - Open trunk ..... 517
  - Seat belt reminder ..... 517
  - Toyota parking assist-sensor ..... 293
- Warning lights** ..... 87
- ABS ..... 515
  - Brake system ..... 513
  - Charging system ..... 513
  - Clutch ..... 514
  - Cruise control ..... 516
  - Electric power steering ..... 515
  - Fuel filter ..... 516
  - High engine coolant temperature ..... 513
  - Low engine oil level ..... 517
  - Low engine oil pressure ..... 513
  - Low fuel level ..... 517
  - Low windshield washer fluid ..... 517
  - Malfunction indicator lamp ..... 514
  - Master warning light ..... 518
  - Multi-mode manual transmission ..... 514
  - Open door ..... 517
  - Seat belt reminder light ..... 517
  - Slip indicator ..... 515
  - SRS ..... 514
  - Tire pressure ..... 519
- Warning messages** ..... 526
- Washer** ..... 232
- Checking ..... 457
  - Preparing and checking before winter ..... 323
  - Switch ..... 232
- Washing and waxing** ..... 428
- Weight** ..... 592
- Wheels** ..... 475
- Replacing ..... 475
  - Size ..... 606
- Window glasses** ..... 169
- Window lock switch** ..... 169
- Windows** ..... 169
- Power windows ..... 169
  - Rear window defogger ..... 394, 403
- Windshield wiper de-icer** ..... 395, 404
- Windshield wipers** ..... 232
- Intermittent wiper with interval adjuster ..... 232
  - Rain-sensing windshield wipers ..... 233
- Winter driving tips** ..... 323
- Wireless remote control key** ..... 117
- Battery-Saving Function ..... 141
  - Locking/Unlocking ..... 127, 134
  - Replacing the battery ..... 480
- WMA disc** ..... 338

### GAS STATION INFORMATION

Auxiliary catch lever P. 441	Trunk opener P. 133	Fuel filler door P. 239
Hood lock release lever P. 441	Fuel filler door opener P. 239	Tire inflation pressure P. 606
<small>CTHPIBC126</small>		
Fuel tank capacity (Reference)	55 L (14.5 gal., 12.1 Imp. gal.)	
Fuel type	P. 597, 609	
Cold tire inflation pressure	P. 606	
Engine oil capacity (Drain and refill — reference)	P. 598	
Engine oil type	"Toyota Genuine Motor Oil" or equivalent P. 598	