

TABLE OF CONTENTS

1	Before driving	Adjusting and operating features such as door locks, mirrors, and steering column.
2	When driving	Driving, stopping and safe-driving information.
3	Interior features	Air conditioning and audio systems, as well as other interior features for a comfortable driving experience.
4	Maintenance and care	Cleaning and protecting your vehicle, performing do-it-yourself maintenance, and maintenance information.
5	When trouble arises	What to do if the vehicle needs to be towed, gets a flat tire, or is involved in an accident.
6	Vehicle specifications	Detailed vehicle information.
	Index	Alphabetical listing of information contained in this manual.

For vehicles with a navigation system, refer to the “Navigation System Owner’s Manual” for information regarding the equipment listed below.

- Navigation system
- Air conditioning
- Hands-free system (for cellular phone)
- Toyota parking assist monitor
- Rear view monitor system
- Rear seat entertainment system
- Audio/video system
- Toyota parking assist-sensor
- Wide view front & side monitor

1 Before driving

1-1. Key information

Keys 34

1-2. Opening, closing and locking the doors

Smart entry & start system 39
 Wireless remote control 66
 Side doors 74
 Back door 81
 Glass hatch 88

1-3. Adjustable components (seats, mirrors, steering wheel)

Front seats 93
 Rear seats 97
 Driving position memory (driver’s seat) 115
 Head restraints 119
 Seat belts 122
 Steering wheel 129
 Inside rear view mirror 132
 Outside rear view mirrors 134

1-4. Opening and closing the windows and moon roof

Power windows 137
 Moon roof 141

1-5. Refueling

Opening the fuel tank cap 146

1-6. Theft deterrent system

Engine immobilizer system 152
 Double locking system 158
 Alarm 160

1-7. Safety information

Correct driving posture 168
 SRS airbags 170
 Child restraint systems 185
 Installing child restraints 197
 Airbag manual on-off system 213

2 When driving

2-1. Driving procedures

Driving the vehicle	218
Engine (ignition) switch (vehicles without a smart entry & start system).....	235
Engine (ignition) switch (vehicles with a smart entry & start system).....	239
Automatic transmission.....	249
Manual transmission.....	258
Turn signal lever	263
Parking brake.....	264
Horn	265

2-2. Instrument cluster

Gauges and meters	266
Indicators and warning lights	270
Multi-information display (Non-Optitron type meters)	276
Multi-information display (Optitron type meters).....	282
Multi-information display (Accessory meters).....	292

2-3. Operating the lights and wipers

Headlight switch	300
Fog light switch	312
Windshield wipers and washer	314
Rear window wiper and washer	320
Headlight cleaner switch	322

2-4. Using other driving systems

Cruise control	324
Dynamic radar cruise control	328
Toyota parking assist-sensor.....	345
Rear view monitor system (vehicles with an accessory meter)	356
Wide view front & side monitor (vehicles with an accessory meter)	361
Driving assist systems.....	373
PCS (Pre-Crash Safety system)	380
Diesel Particulate Filter system (diesel engine only).....	389

2-5. Driving information

Cargo and luggage.....	392
Winter driving tips.....	396
Trailer towing.....	400

1

2

3

4

5

6

3 Interior features

3-1. Using the air conditioning system and defogger

Front manual air conditioning system 418

Front automatic air conditioning system 425

Rear manual air conditioning system 435

Rear automatic air conditioning system 438

Heater idle up switch 442

Power heater 443

Rear window defogger switch 444

Windshield wiper de-icer 447

3-2. Using the audio system

Audio system types 449

Using the radio 453

Using the CD player 458

Playing MP3 and WMA discs 468

Operating an iPod 477

Operating a USB memory 486

Optimal use of the audio system 496

Using the AUX port 499

Using the steering wheel audio switches 501

3-3. Using the Bluetooth® audio system

Bluetooth® audio system 504

Using the Bluetooth® audio system 511

Operating a Bluetooth® enabled portable player 514

Setting up a Bluetooth® enabled portable player 518

Bluetooth® audio system setup 522

3-4. Using the hands-free system (for mobile phone)

Hands-free system (for mobile phone) 523

Using the hands-free system (for mobile phone) 532

Making a phone call 539

Setting a mobile phone 543

Security and system setup 546

Using the phone book 551

3-5. Using the interior lights

Interior lights list 557

- Personal/interior light main switch 558
- Personal/interior lights 559
- Lounge illumination control switches 560

3-6. Using the storage features

List of storage features	562
• Glove box	563
• Card holder	564
• Console box	565
• Bottle holders/door pockets	567
• Cup holders	569
• Auxiliary boxes	573

3-7. Other interior features

Cool box	576
Sun visors	579
Vanity mirror	580
Clock	581
Outside temperature display	582
Ashtray	584
Conversation mirror	585
Power outlet	586
Seat heaters	590
Armrest	593
Coat hooks	594
Assist grips	595
Floor mat	596
Luggage compartment features	598

4 Maintenance and care

4-1. Maintenance and care

Cleaning and protecting the vehicle exterior	606
Cleaning and protecting the vehicle interior	610

4-2. Maintenance

Maintenance requirements	613
-----------------------------------	-----

4-3. Do-it-yourself maintenance

Do-it-yourself service precautions	617
Hood	622
Engine compartment	623
Tires	645
Tire inflation pressure	649
Wheels	652
Air conditioning filter	654
Wireless remote control/electronic key battery	656
Checking and replacing fuses	661
Light bulbs	675

5 When trouble arises

5-1. Essential information

Emergency flashers	692
If your vehicle needs to be towed	694
If you think something is wrong	701
Fuel pump shut off system (gasoline engine only)	702

5-2. Steps to take in an emergency

If a warning light turns on or a warning buzzer sounds... 703

If a warning message is displayed 718

If you have a flat tire (vehicles with a standard spare tire) 743

If you have a flat tire (vehicles with an emergency tire puncture repair kit)..... 765

If the engine will not start..... 786

If the shift lever cannot be shifted from P 789

If you lose your keys/wireless remote control transmitter..... 790

If the electronic key does not operate properly 791

If the vehicle battery is discharged 795

If your vehicle overheats..... 803

If you run out of fuel and the engine stalls (diesel engine only) 806

If the vehicle becomes stuck 807

If your vehicle has to be stopped in an emergency 809

6 Vehicle specifications

6-1. Specifications

Maintenance data (fuel, oil level, etc.) 812

Fuel information 844

6-2. Customization

Customizable features 849

6-3. Initialization

Items to initialize..... 862

Index

Abbreviation list 864

Alphabetical index 865

What to do if... 875

امداد خودرو فارما

تلفن شبانه روزی: ۰۲۱-۸۸۸۶۲۰۸۵

FarmaSOS.com

1

2

3

4

5

6

Pictorial index

Exterior

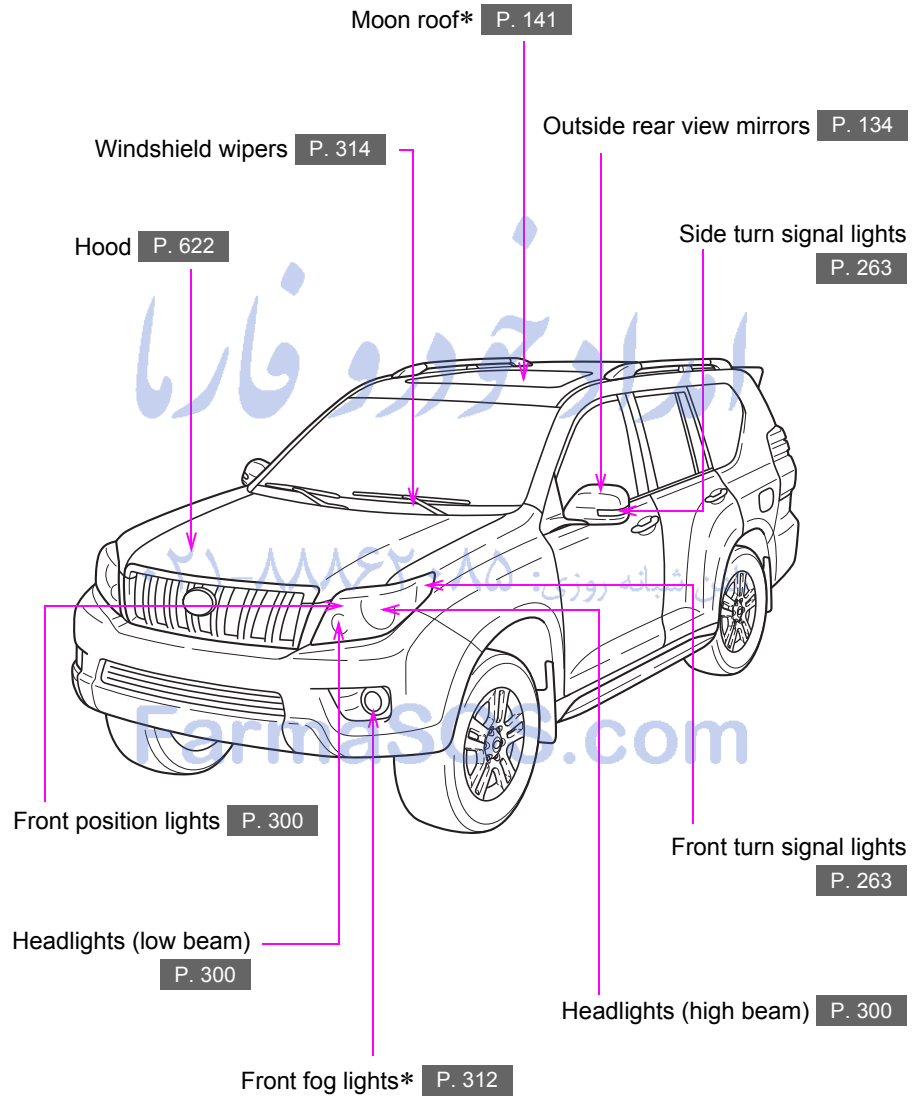

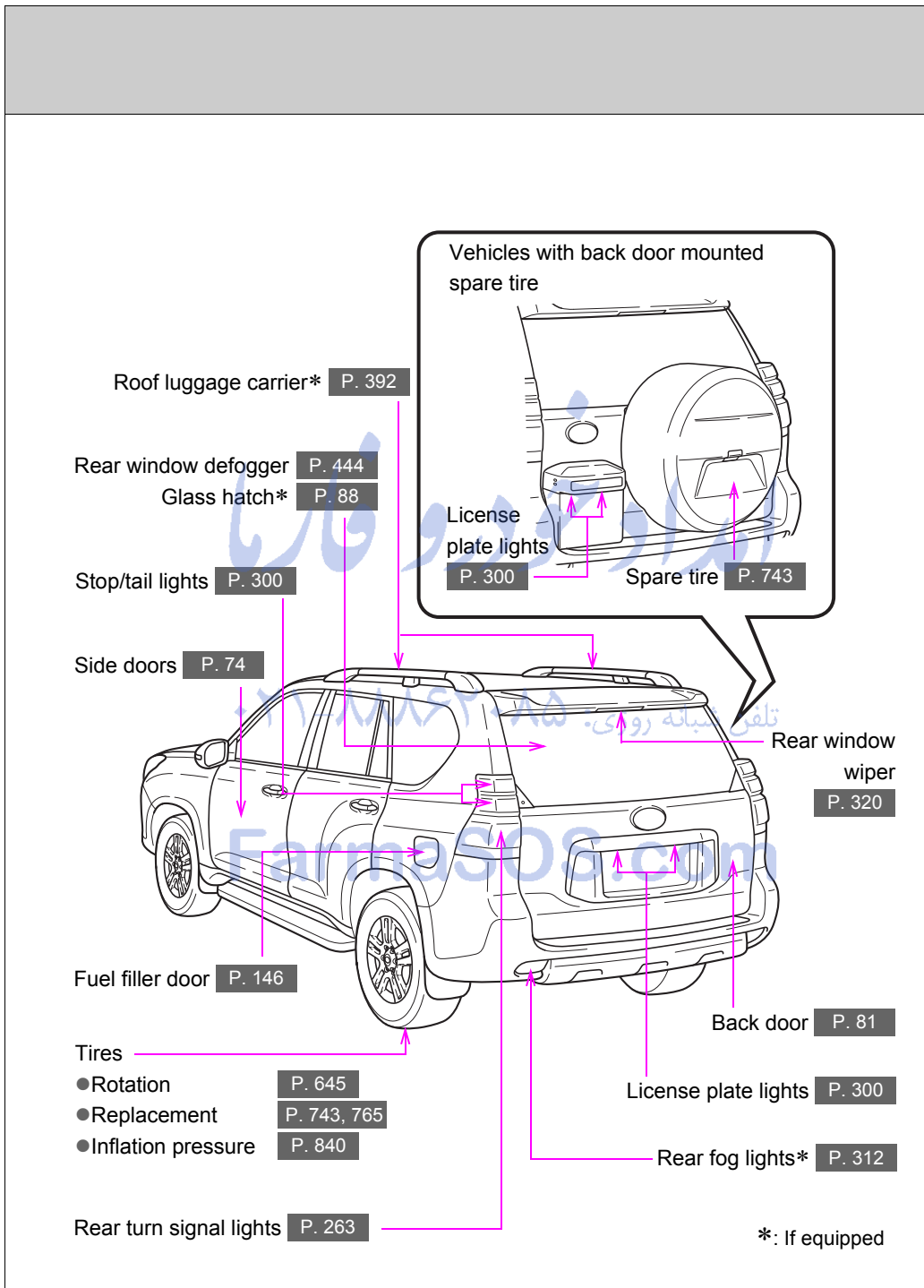

Pictorial index

Interior (Left-hand drive vehicles)

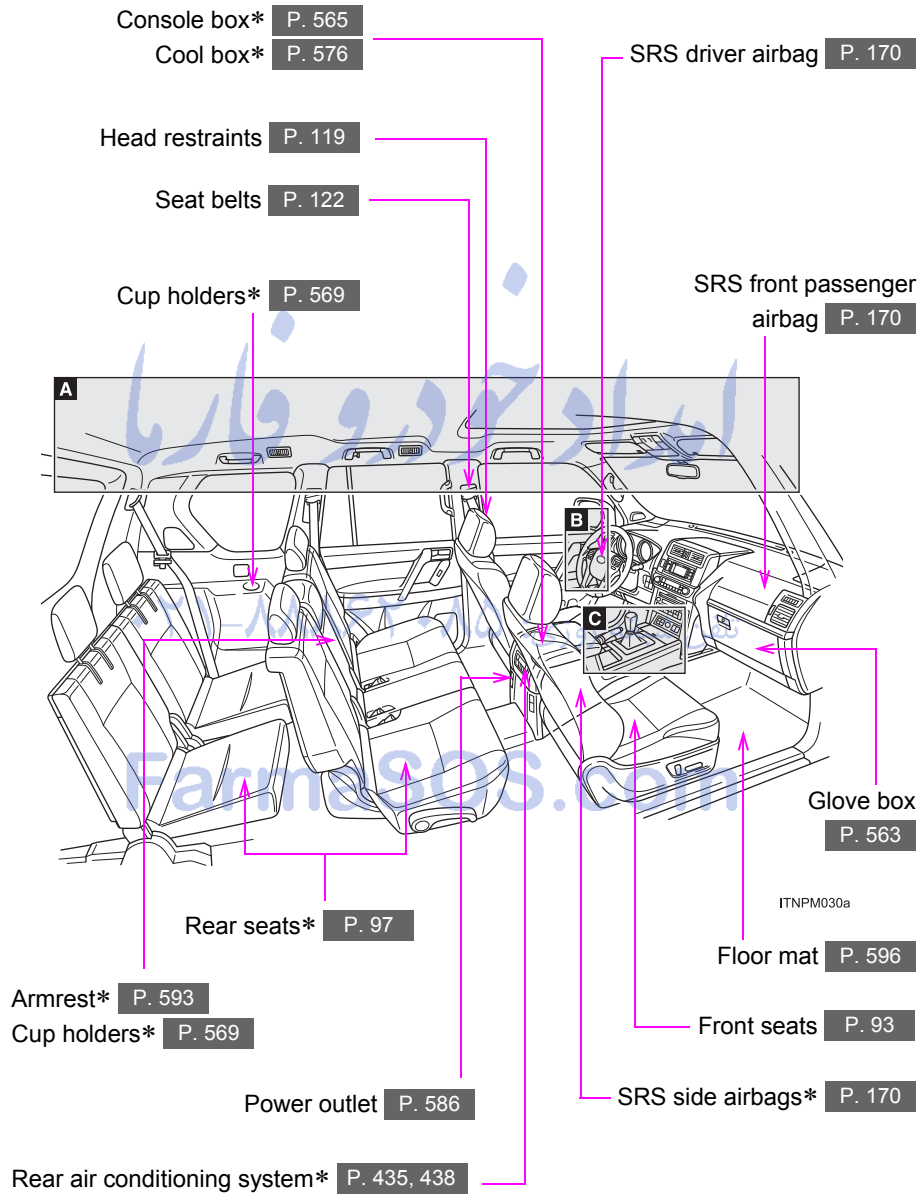

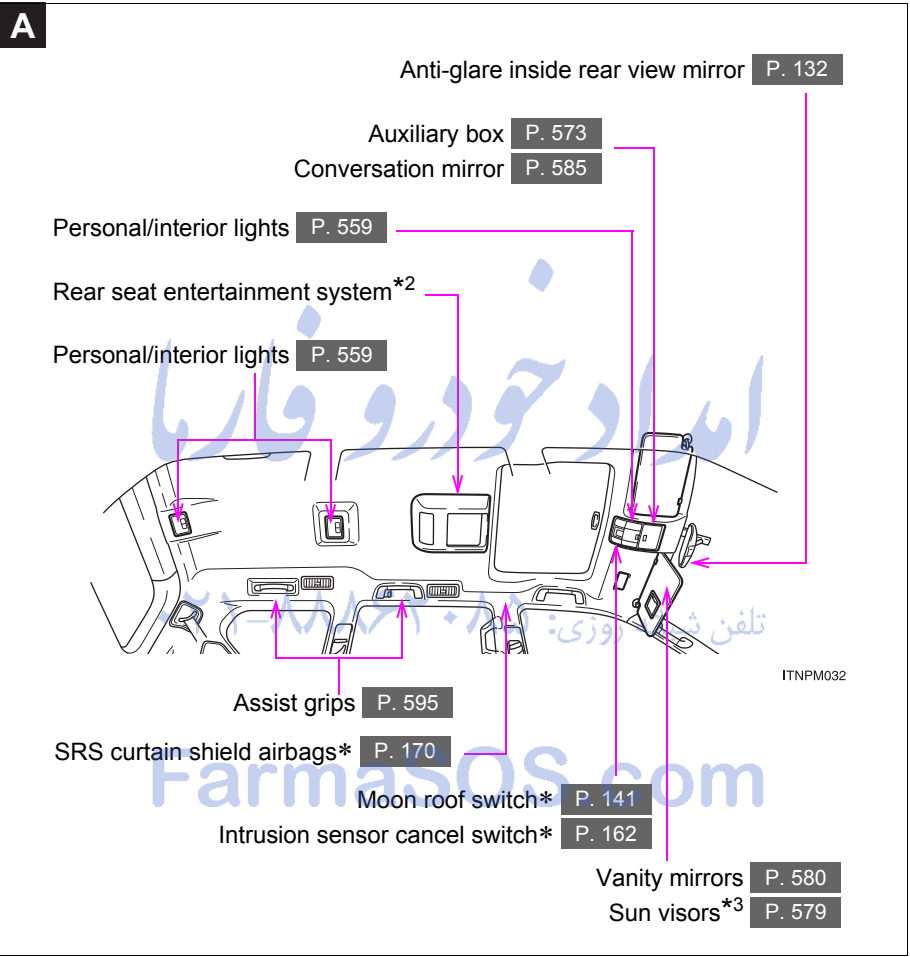

*: If equipped

*²: Refer to the "Navigation System Owner's Manual".

*³: NEVER use a rearward facing child restraint on a seat protected by an ACTIVE AIRBAG in front of it, DEATH or SERIOUS INJURY to the CHILD can occur. (→P. 209)



B

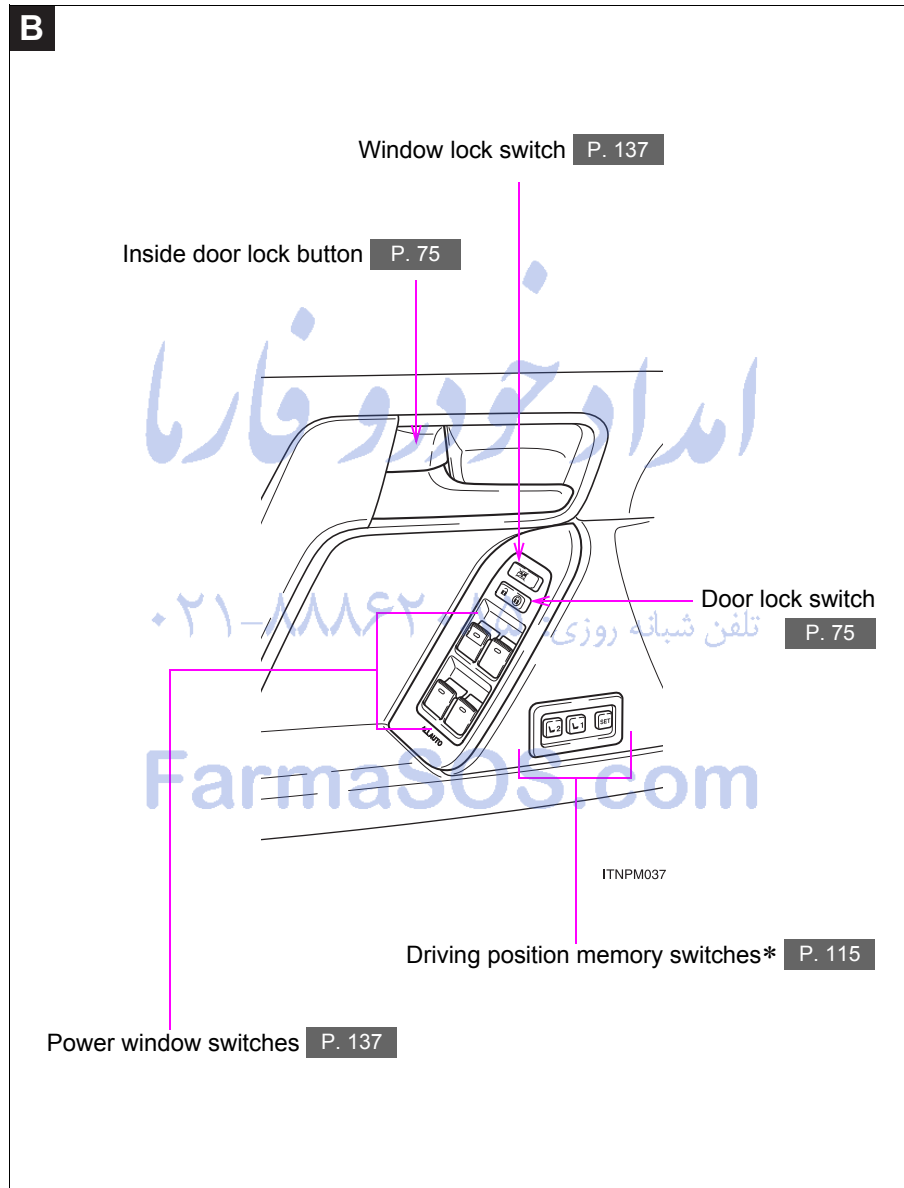

C

Vehicles with an automatic transmission

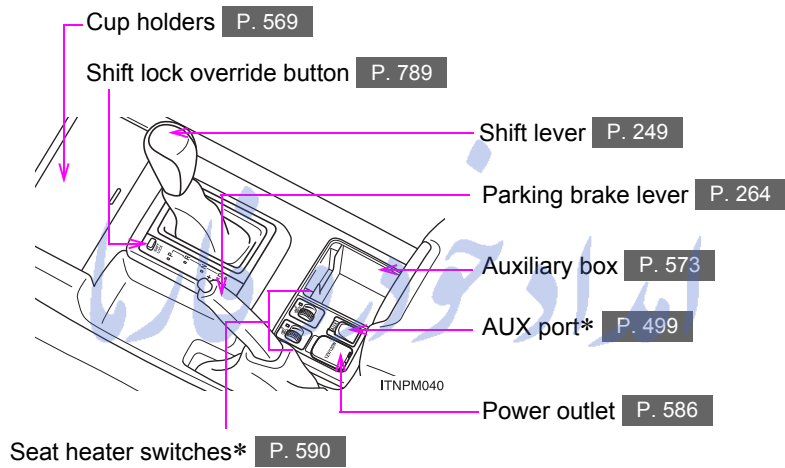

Vehicles with a manual transmission

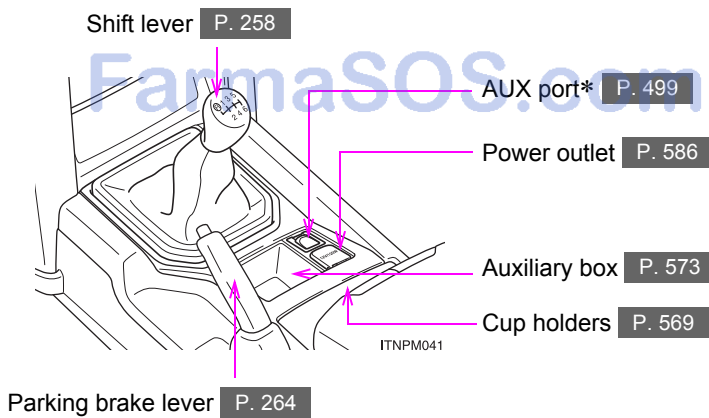

*: If equipped

Pictorial index

Instrument panel (Left-hand drive vehicles)

Windshield wipers and washer switch P. 314

Rear window wiper and washer switch P. 320

Gauge and meters P. 266

Headlight switch P. 300

Turn signal lever P. 263

Fog light switch* P. 312

Emergency flasher switch P. 692

Accessory meter* P. 292

Audio system* P. 449

Navigation system*²

Audio system**² P. 449

Auxiliary box* P. 573

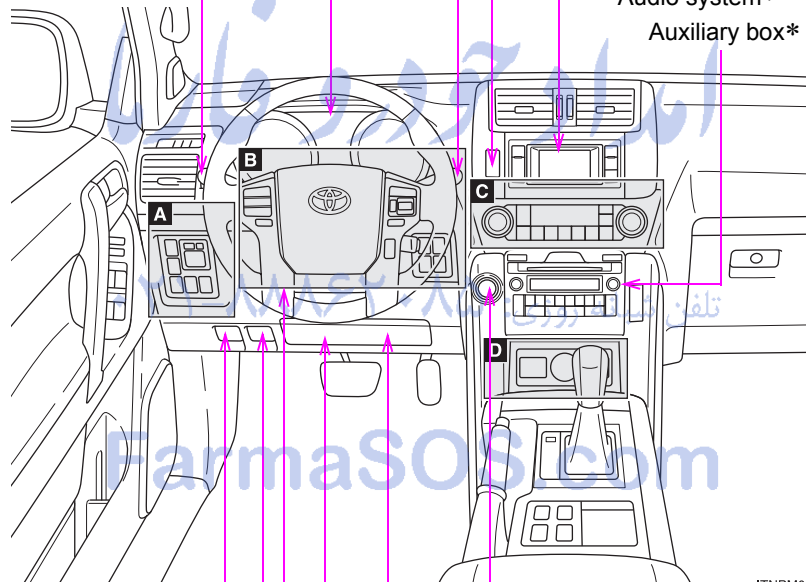

Fuel filler door opener

P. 146

Hood release lever

P. 622

Engine (ignition) switch (vehicles with a smart entry & start system) P. 239

SRS driver knee airbag* P. 170

Pre-crash braking off switch* P. 381

Tilt and telescopic steering control switch* P. 129

Tilt and telescopic steering lock release lever* P. 129

ITNPM026

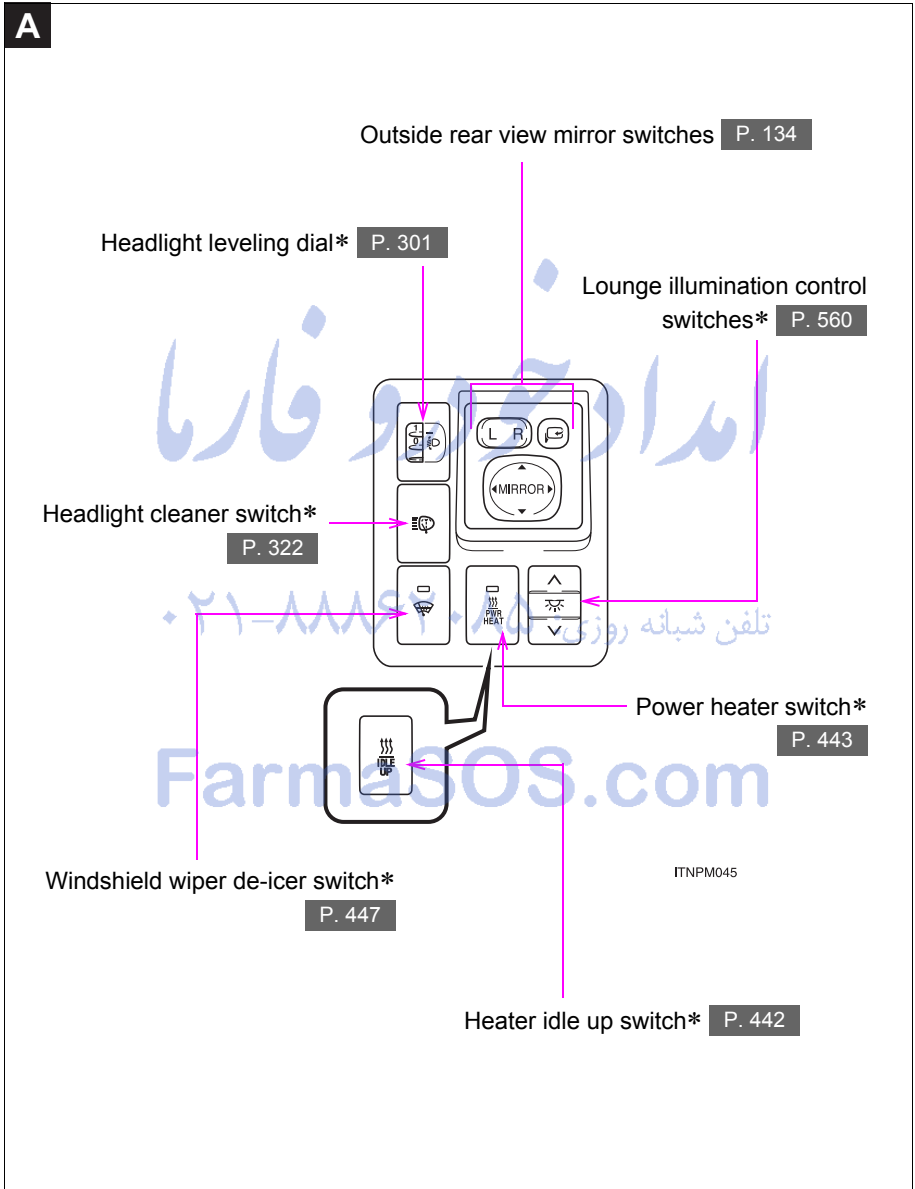

*: If equipped

*2: Refer to the "Navigation System Owner's Manual".

Pictorial index

Instrument panel (Left-hand drive vehicles)

B

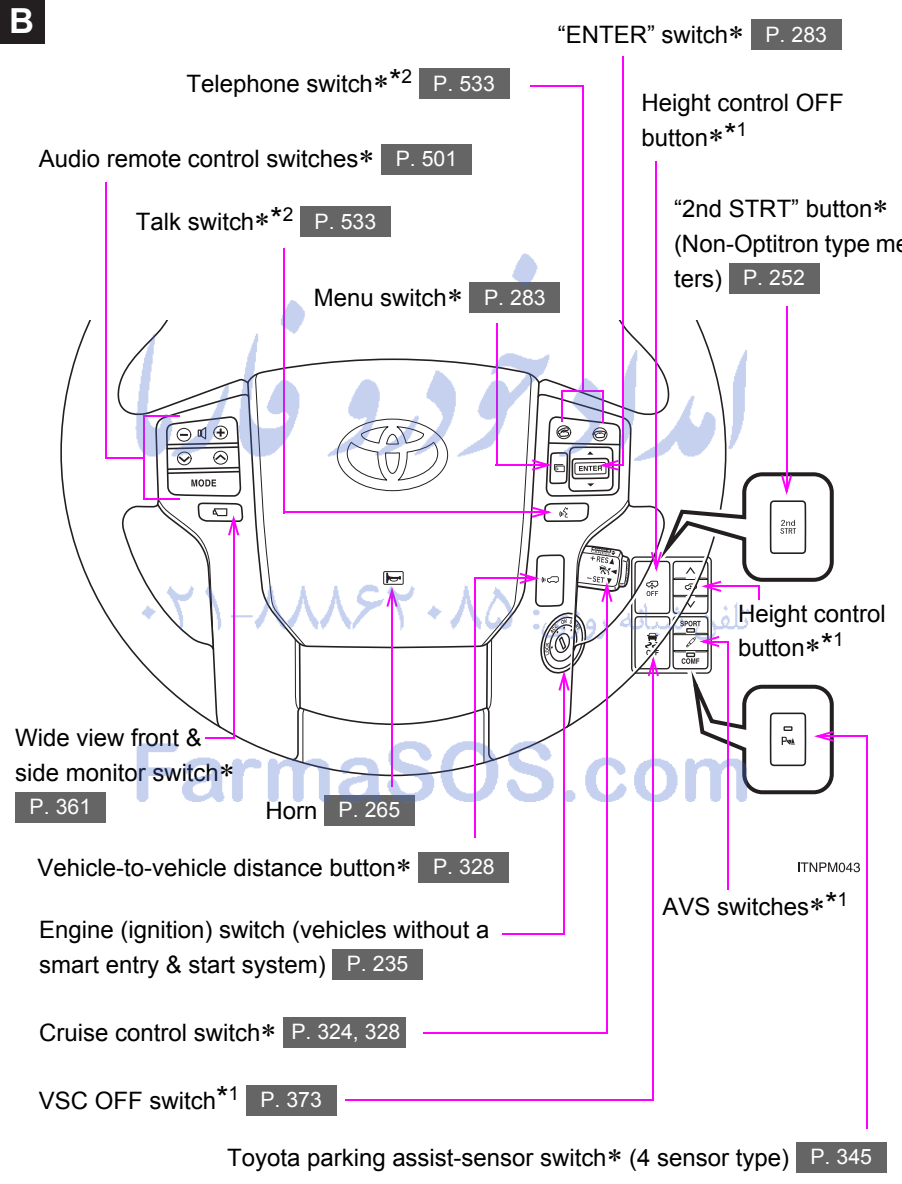

C

Vehicles with a front manual air conditioning system

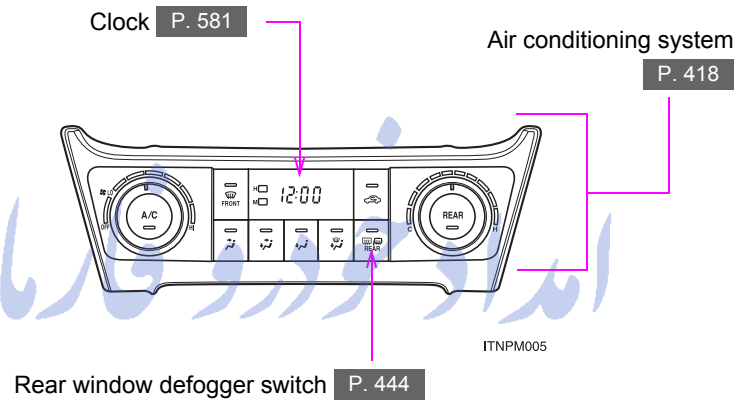

Vehicles with a front automatic air conditioning system

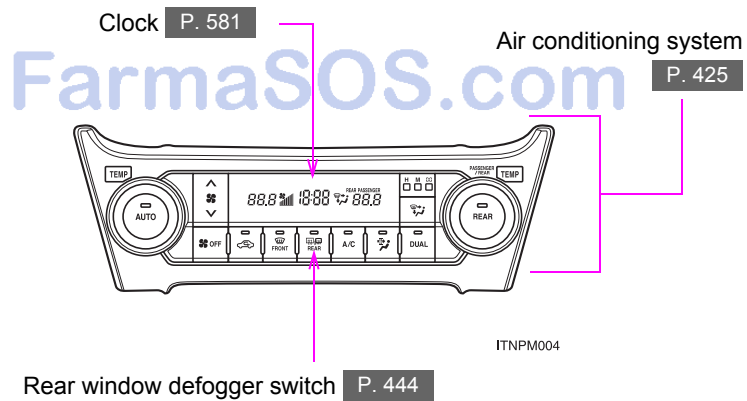

- *: If equipped
- *1: Refer to the "Off-road Driving Owner's Manual".
- *2: Refer to the "Navigation System Owner's Manual".

D

Vehicles with a standard type automatic transmission or 5-speed manual transmission

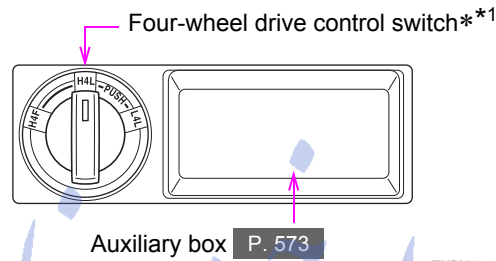

Vehicles with a multi-mode type automatic transmission

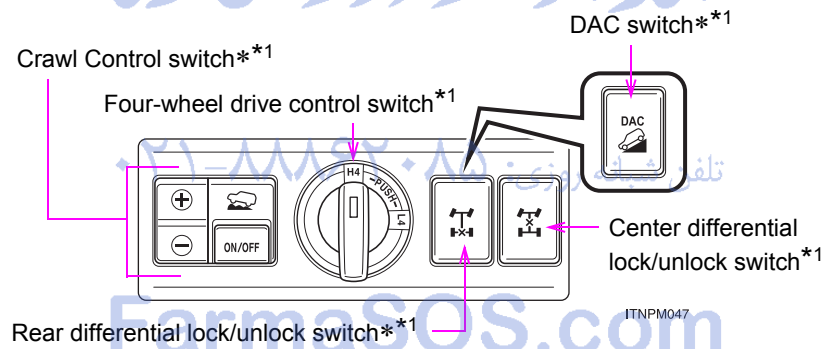

Vehicles with a 6-speed manual transmission

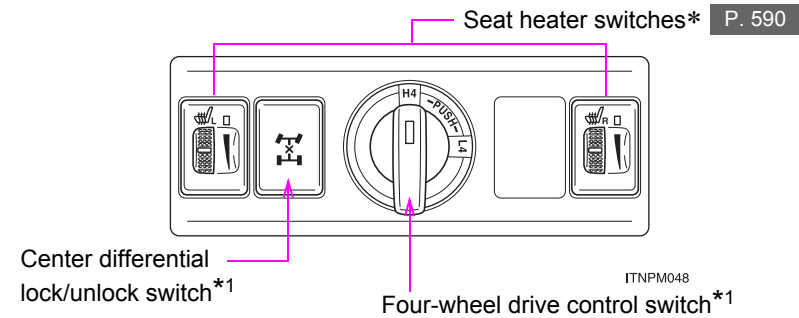

Pictorial index

Interior (Right-hand drive vehicles)

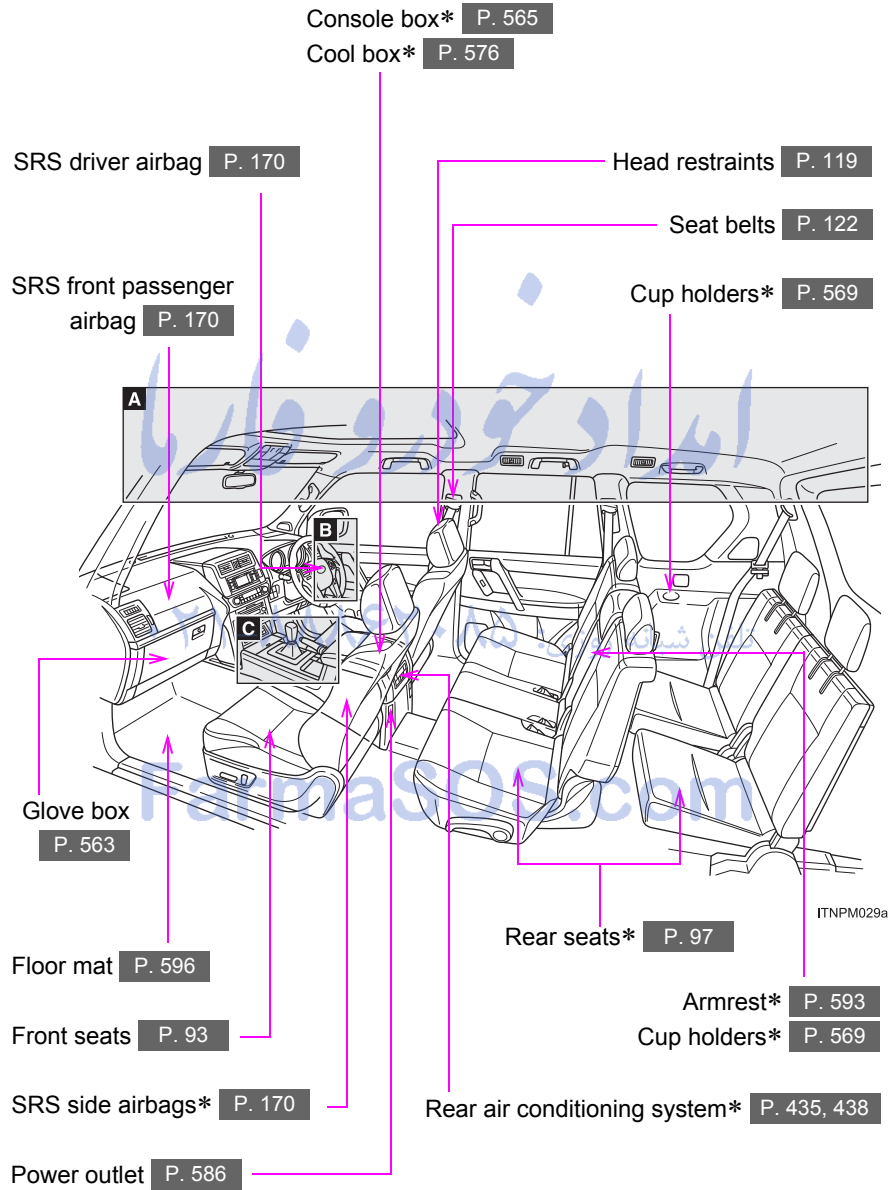

*: If equipped

*1: Refer to the "Off-road Driving Owner's Manual".

Pictorial index

Interior (Right-hand drive vehicles)

A

Anti-glare inside rear view mirror P. 132

Auxiliary box P. 573

Conversation mirror P. 585

Personal/interior lights P. 559

Rear seat entertainment system*²

Personal/interior lights P. 559

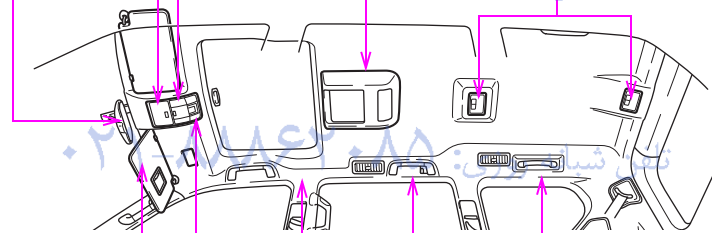

ITNPM031

Assist grips P. 595

SRS curtain shield airbags* P. 170

Moon roof switch* P. 141

Intrusion sensor and tilt sensor cancel switch* P. 162

Vanity mirrors P. 580

Sun visors*³ P. 579

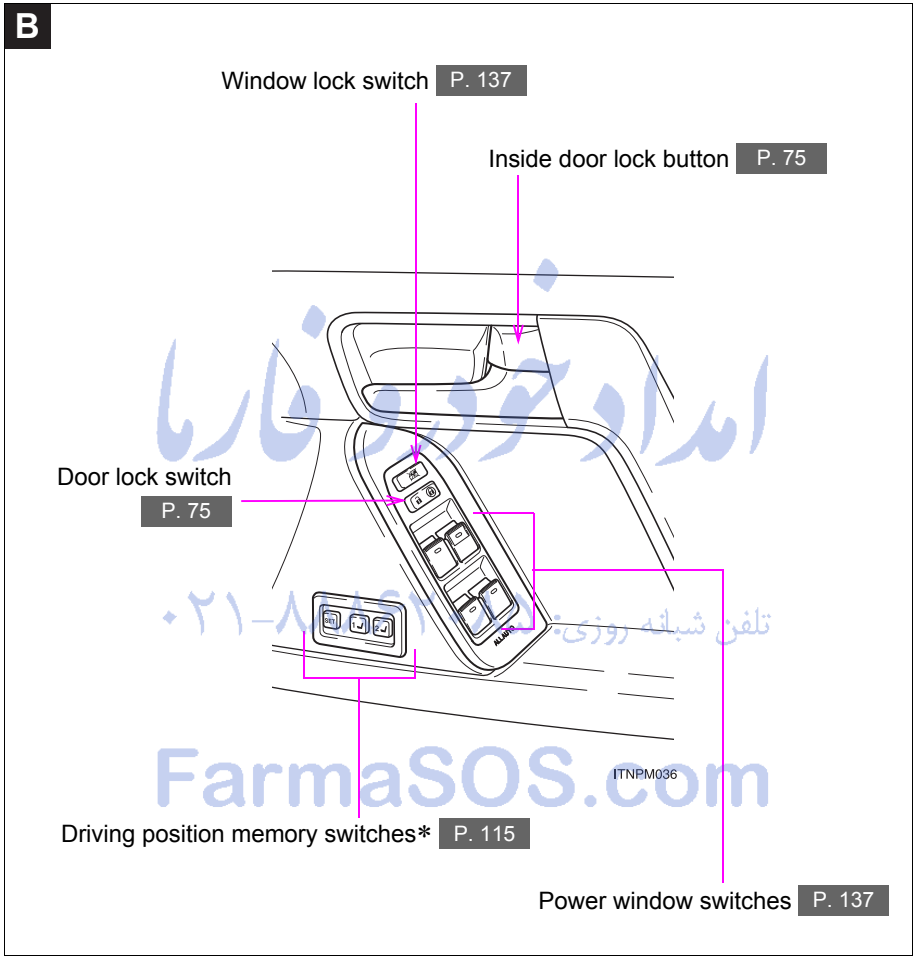

- *: If equipped
- *2: Refer to the "Navigation System Owner's Manual".
- *3: NEVER use a rearward facing child restraint on a seat protected by an ACTIVE AIRBAG in front of it, DEATH or SERIOUS INJURY to the CHILD can occur. (→P. 209)



C

Vehicles with an automatic transmission

AUX port* P. 499

Auxiliary box
P. 573

Shift lever P. 249

Cup holders P. 569

Shift lock override
button P. 789

Parking brake lever P. 264

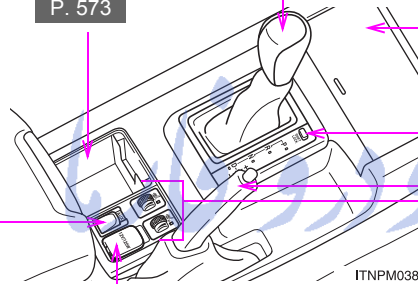

Power outlet P. 586

Seat heater switches* P. 590

Vehicles with a manual transmission

Power outlet P. 586

Shift lever P. 258

AUX port* P. 499

Parking brake lever P. 264

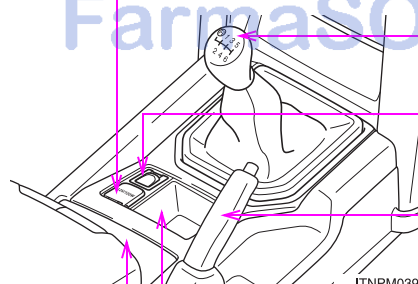

Cup holders P. 569

Auxiliary box P. 573

Pictorial index

Instrument panel (Right-hand drive vehicles)

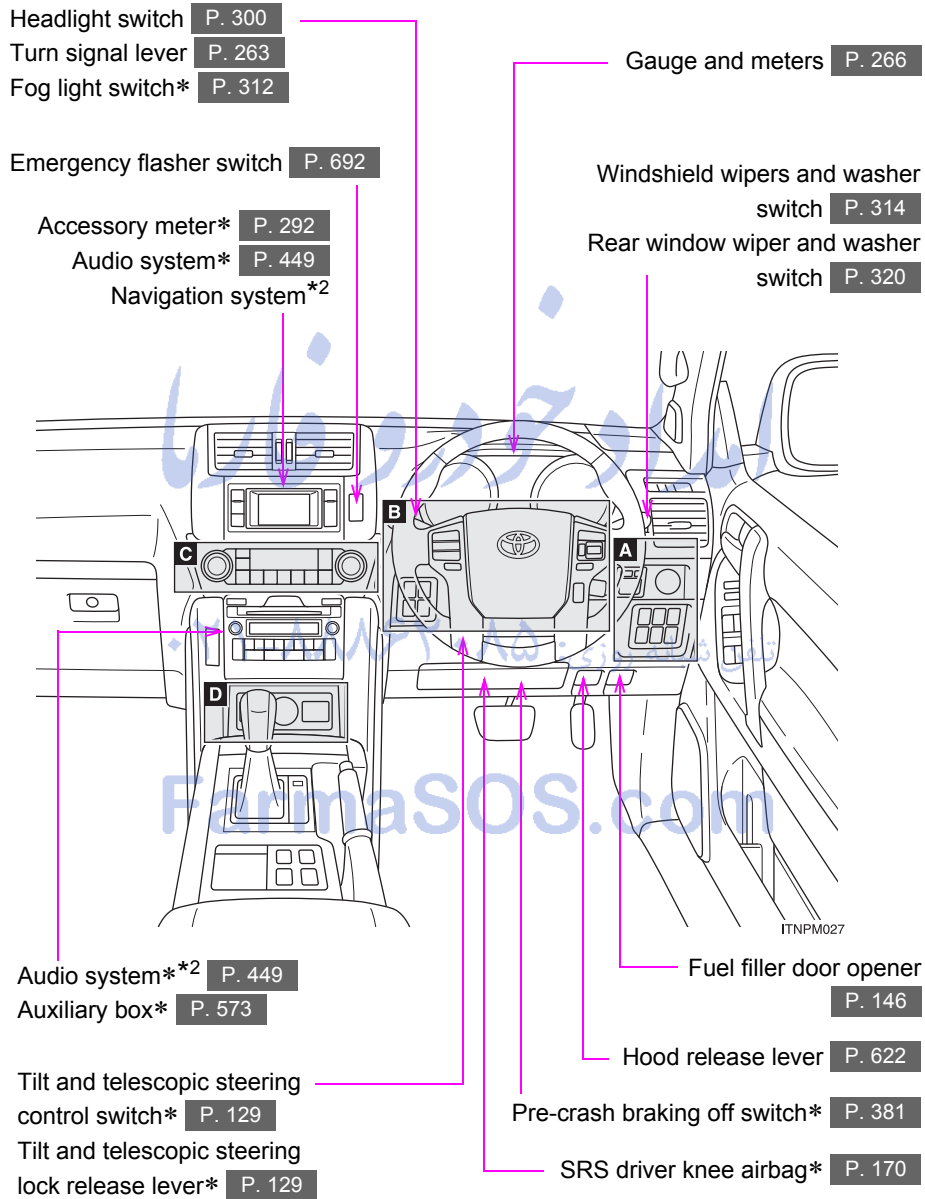

*: If equipped

*²: Refer to the "Navigation System Owner's Manual".

A

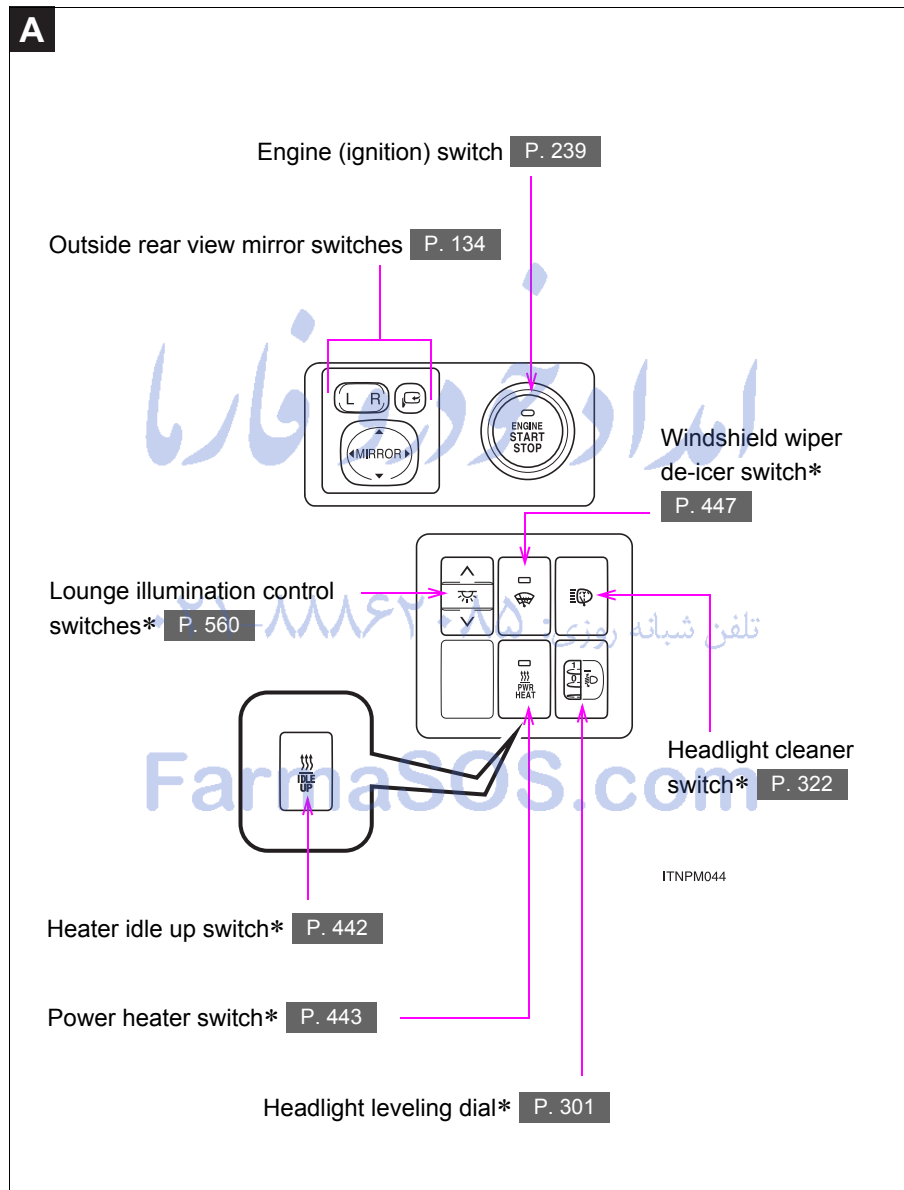

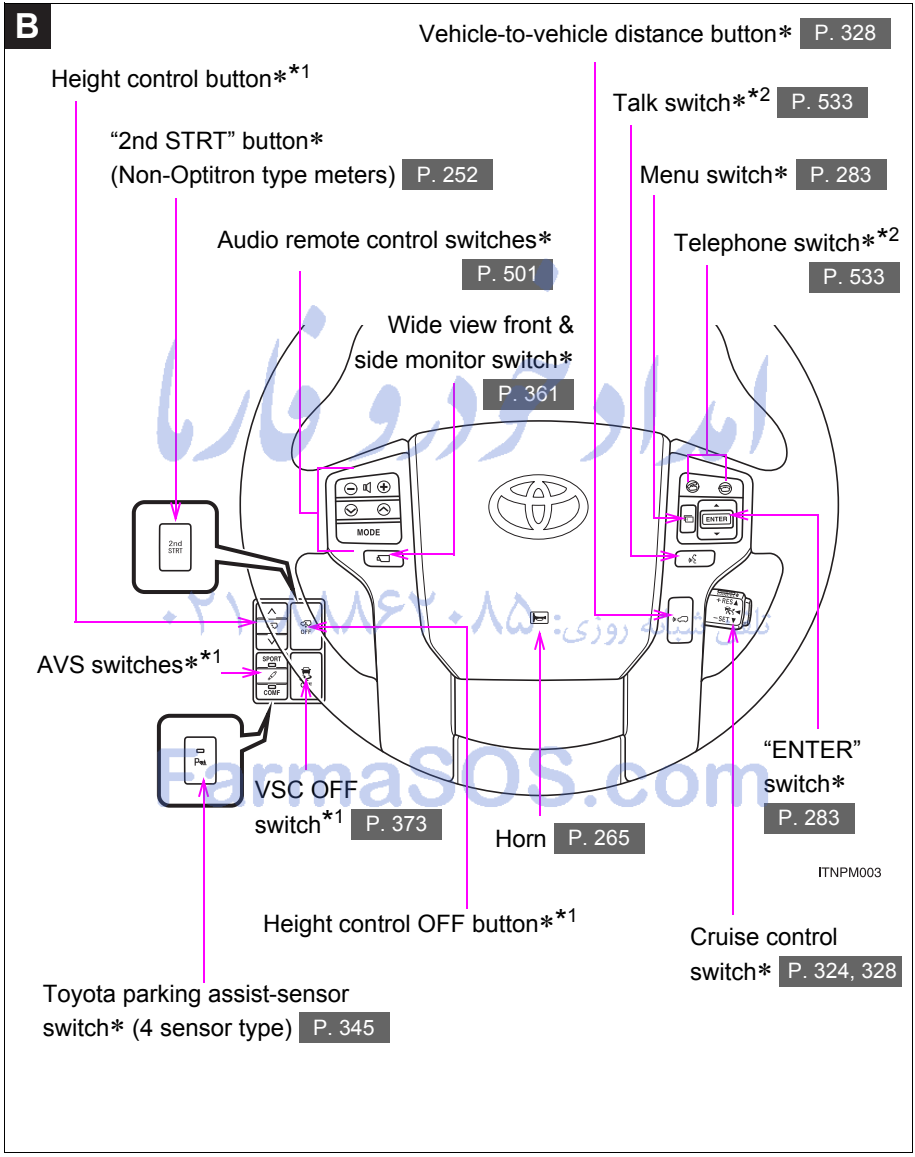

*: If equipped
 *1: Refer to the "Off-road Driving Owner's Manual".
 *2: Refer to the "Navigation System Owner's Manual".

C

Vehicles with a front manual air conditioning system

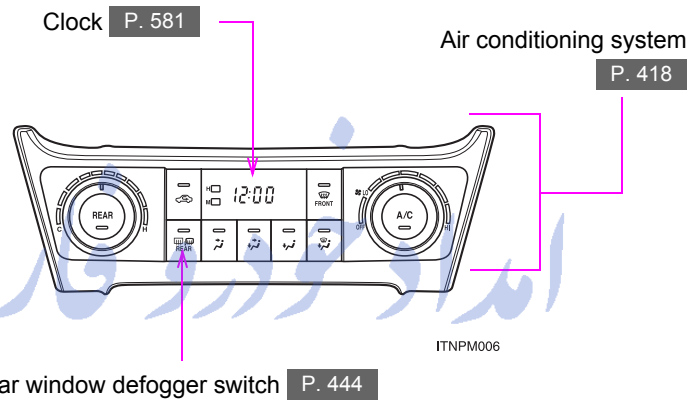

Vehicles with a front automatic air conditioning system

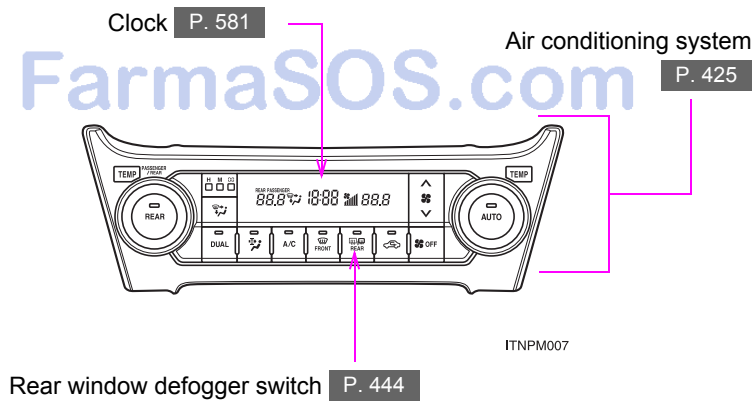

D

Vehicles with a multi-mode type automatic transmission

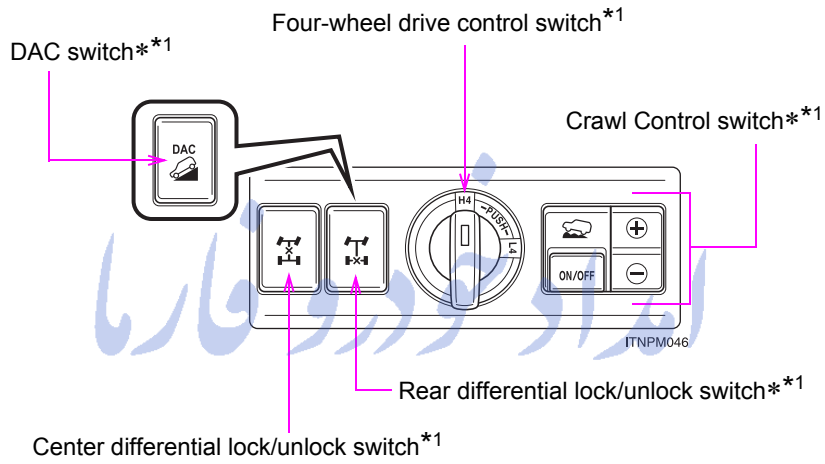

Vehicles with a 6-speed manual transmission تلفن شبانه روزی: ۰۲۱-۸۸۸۶۲۰۸۸

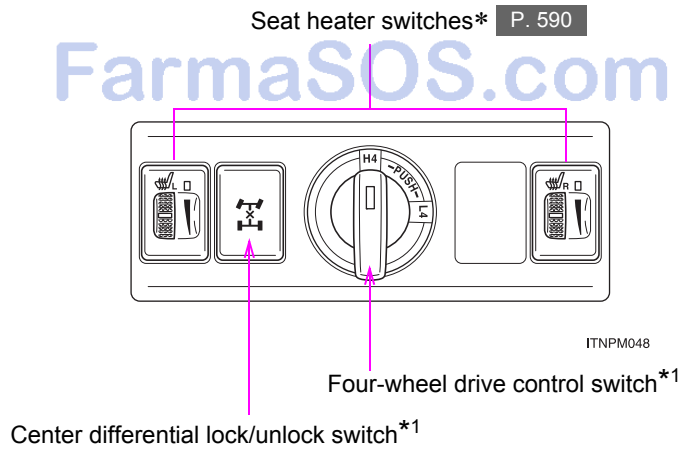

*: If equipped

*¹: Refer to the "Off-road Driving Owner's Manual".

For your information

Main Owners Manual

Please note that this manual applies to all models and all equipment, including options. Therefore, you may find some explanations for equipment not installed on your vehicle.

All specifications provided in this manual are current at the time of printing. However, because of the Toyota policy of continual product improvement, we reserve the right to make changes at any time without notice.

Depending on specifications, the vehicle shown in the illustrations may differ from your vehicle in terms of equipment.

Accessories, spare parts and modification of your Toyota

Both genuine Toyota and a wide variety of other spare parts and accessories for Toyota vehicles are currently available on the market. Should it be determined that any of the genuine Toyota parts or accessories supplied with the vehicle need to be replaced, Toyota recommends that genuine Toyota parts or accessories, be used to replace them. Other parts or accessories of matching quality can also be used. Toyota cannot accept any liability or guarantee spare parts and accessories which are not genuine Toyota products, nor for replacement or installation involving such parts. In addition, damage or performance problems resulting from the use of non-genuine Toyota spare parts or accessories may not be covered under warranty.

Installation of an RF-transmitter system

As the installation of an RF-transmitter system in your vehicle could affect electronic systems such as the multi-port fuel injection system/sequential multi-port fuel injection system, cruise control system, anti-lock brake system, SRS airbag system and seat belt pretensioner system, be sure to check with any authorized Toyota dealer or repairer, or another duly qualified and equipped professional for precautionary measures or special instructions regarding installation.

Further information regarding frequency bands, power levels, antenna positions and installation provisions for the installation of RF-transmitters, is available on request at any authorized Toyota dealer or repairer, or another duly qualified and equipped professional.

Scrapping of your Toyota

The SRS airbag and seat belt pretensioner devices in your Toyota contain explosive chemicals. If the vehicle is scrapped with the airbags and seat belt pretensioners left as they are, this may cause an accident such as fire. Be sure to have the systems of the SRS airbag and seat belt pretensioner removed and disposed of by a qualified service shop or by any authorized Toyota dealer or repairer, or another duly qualified and equipped professional, before you scrap your vehicle.

FarmaSOS.com



Your vehicle contains batteries and/or accumulators. Do not discard them into the environment but cooperate with separate collection (Directive 2006/66/EC).

⚠ CAUTION

■ **General precautions while driving**

Driving under the influence: Never drive your vehicle when under the influence of alcohol or drugs that have impaired your ability to operate your vehicle. Alcohol and certain drugs delay reaction time, impair judgment and reduce coordination, which could lead to an accident that could result in death or serious injury.

Defensive driving: Always drive defensively. Anticipate mistakes that other drivers or pedestrians might make and be ready to avoid accidents.

Driver distraction: Always give your full attention to driving. Anything that distracts the driver, such as adjusting controls, talking on a cellular phone or reading can result in a collision with resulting death or serious injury to you, your occupants or others.

 CAUTION

■ **General precaution regarding children's safety**

Never leave children unattended in the vehicle, and never allow children to have or use the key.

Children may be able to start the vehicle or shift the vehicle into neutral. There is also a danger that children may injure themselves by playing with the windows, the moon roof, or other features of the vehicle. In addition, heat build-up or extremely cold temperatures inside the vehicle can be fatal to children.

امداد خودرو فارما

تلفن شبانه روزی: ۰۲۱-۸۸۸۶۲۰۸۵

FarmaSOS.com

Symbols used throughout this manual

Cautions & Notices

CAUTION

This is a warning against something which, if ignored, may cause death or serious injury to people. You are informed about what you must or must not do in order to reduce the risk of death or serious injury to yourself and others.

NOTICE

This is a warning against something which, if ignored, may cause damage to the vehicle or its equipment. You are informed about what you must or must not do in order to avoid or reduce the risk of damage to your Toyota and its equipment.

Symbols used in illustrations



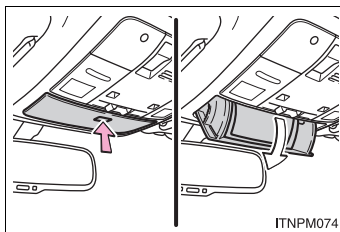

Safety symbol

The symbol of a circle with a slash through it means “Do not”, “Do not do this”, or “Do not let this happen”.



Arrows indicating operations

-  Indicates the action (pushing, turning, etc.) used to operate switches and other devices.
-  Indicates the outcome of an operation (e.g. a lid opens).

Before driving

1

1-1. Key information		1-4. Opening and closing the windows and moon roof	
Keys.....	34	Power windows.....	137
1-2. Opening, closing and locking the doors		Moon roof.....	141
Smart entry & start system	39	1-5. Refueling	
Wireless remote control.....	66	Opening the fuel tank cap.....	146
Side doors	74	1-6. Theft deterrent system	
Back door	81	Engine immobilizer system	152
Glass hatch.....	88	Double locking system	158
1-3. Adjustable components (seats, mirrors, steering wheel)		Alarm	160
Front seats.....	93	1-7. Safety information	
Rear seats	97	Correct driving posture.....	168
Driving position memory (driver's seat).....	115	SRS airbags.....	170
Head restraints	119	Child restraint systems	185
Seat belts.....	122	Installing child restraints.....	197
Steering wheel.....	129	Airbag manual on-off system	213
Inside rear view mirror	132		
Outside rear view mirrors	134		

1-1. Key information

Keys

The following keys are provided with the vehicle.

Vehicles with wireless remote control transmitter

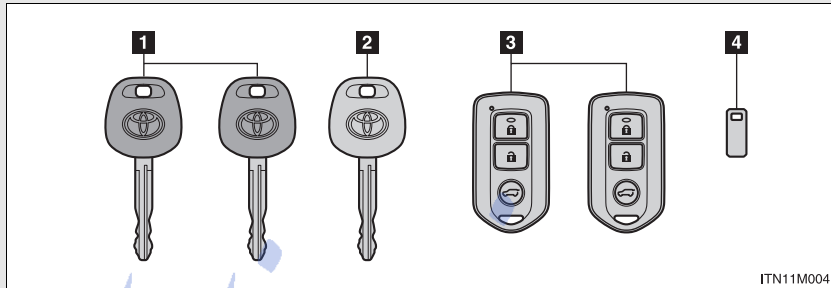

1 Master keys

2 Valet key

3 Wireless remote controls

Operating the wireless remote control function (→P. 66)

4 Key number plate

تلفن شبانه روزی: ۰۲۱-۸۸۸۶۲۰۸۵

FarmaSOS.com

Vehicles without a smart entry & start system

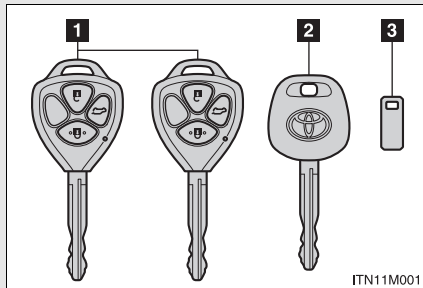

1 Master keys

Operating the wireless remote control function (→P. 66)

2 Valet key

3 Key number plate

Vehicles with a smart entry & start system

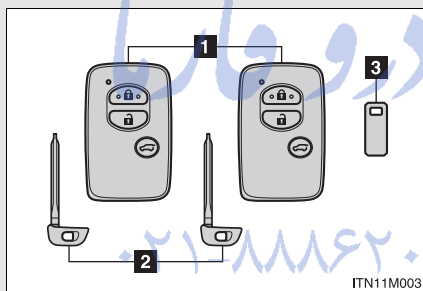

1 Electronic keys

- Operating the smart entry & start system (→P. 39)
- Operating the wireless remote control function (→P. 66)

2 Mechanical keys

3 Key number plate

1

Before driving

FarmaSOS.com

Using the mechanical key (vehicles with a smart entry & start system)

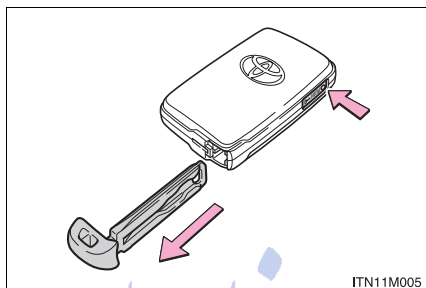

To take out the mechanical key, push the release button and take the key out.

After using the mechanical key, store it in the electronic key. Carry the mechanical key together with the electronic key. If the electronic key battery depleted or the entry function does not operate properly, you will need the mechanical key. (→P. 791)

■ **When required to leave the vehicle's key to the vehicle with a parking attendant**

Lock the glove box as circumstances demand. (→P. 563)

Vehicles without a smart entry & start system

Carry the master key for your own use and provide the attendant with the valet key.

Vehicles with a smart entry & start system

Remove the mechanical key for your own use and provide the attendant with the electronic key only.

■ Key number plate

Keep the plate in a safe place such as your wallet, not in the vehicle. In the event that a key (without a smart entry & start system) or mechanical key (with a smart entry & start system) is lost, a new key can be made by any authorized Toyota dealer or repairer, or another duly qualified and equipped professional using the key number plate. (→P. 790)

■ When riding in an aircraft

When bringing a key with wireless remote control function onto an aircraft, make sure you do not press any buttons on the key while inside the aircraft cabin. If you are carrying the key in your bag etc., ensure that the buttons are not likely to be pressed accidentally. Pressing a button may cause the key to emit radio waves that could interfere with the operation of the aircraft.

1

Before driving

⚠ NOTICE

■ To prevent key damage

Observe the following:

- Do not drop the keys, subject them to strong shocks or bend them.
- Do not expose the keys to high temperatures for a long period of time.
- Do not get the keys wet or wash them in an ultrasonic washer etc.
- Do not attach metallic or magnetic materials to the keys or place the keys close to such materials.
- Do not disassemble the keys.
- Do not attach a sticker or anything else to the surface of the electronic key.
- Do not place the keys near objects that produce magnetic fields, such as TVs, audio systems, induction cookers, or medical electrical equipment, such as low-frequency therapy equipment.

 NOTICE

■ **Carrying the electronic key on your person**

Carry the electronic key 10 cm (3.9 in.) or more away from electric appliances that are turned on. Radio waves emitted from electric appliances within 10 cm (3.9 in.) of the electronic key may interfere with the key, causing the key to not function properly.

■ **In case of a smart entry & start system malfunction or other key-related problems**

Take your vehicle with all the electronic keys provided with your vehicle to any authorized Toyota dealer or repairer, or another duly qualified and equipped professional.

■ **When a vehicle key is lost**

If the key remains lost, the risk of vehicle theft increases significantly. Visit any authorized Toyota dealer or repairer, or another duly qualified and equipped professional immediately with all remaining keys that was provided with your vehicle.

تلفن شبانه روزی: ۰۲۱-۸۸۶۲۰۸۵

FarmaSOS.com

1-2. Opening, closing and locking the doors Smart entry & start system*

The following operations can be performed simply by carrying the electronic key on your person, for example in your pocket.
(The driver should always carry the electronic key.)

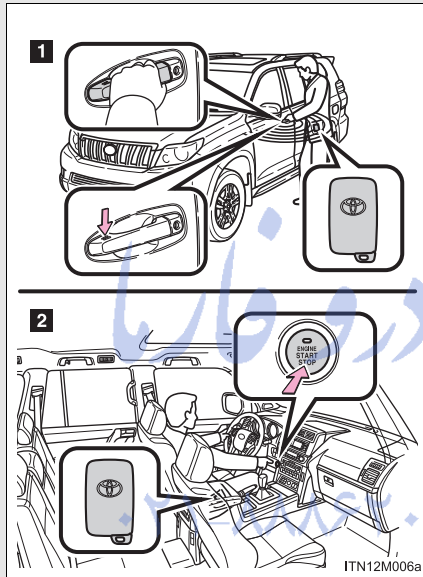

- 1 Locks and unlocks the doors (→P. 41)
- 2 Starts the engine (→P. 239)

1

Before driving

FarmaSOS.com

*: If equipped

1-2. Opening, closing and locking the doors

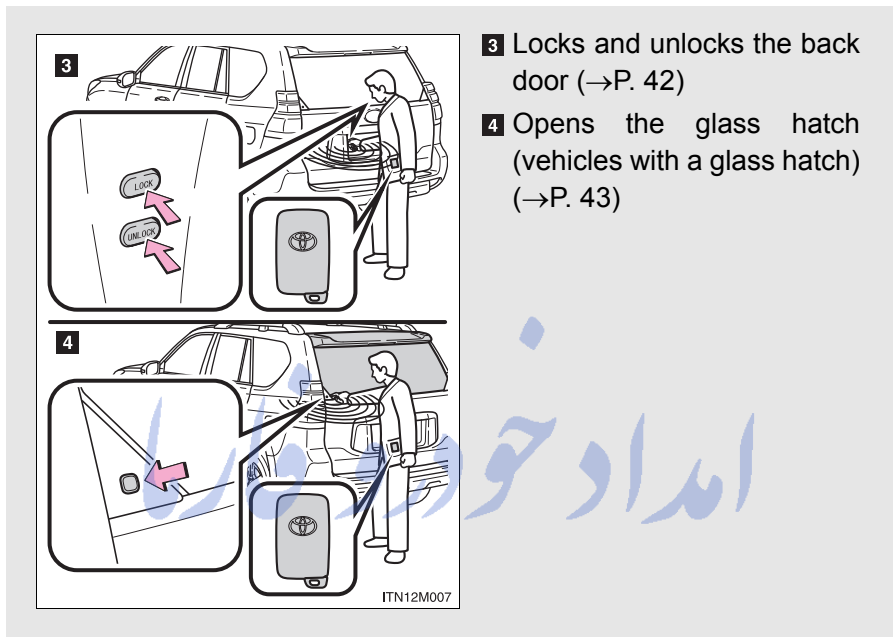

تلفن شبانه روزی: ۰۲۱-۸۸۶۲۰۸۵

FarmaSOS.com

1-2. Opening, closing and locking the doors

Unlocking and locking the doors (front door handles only)

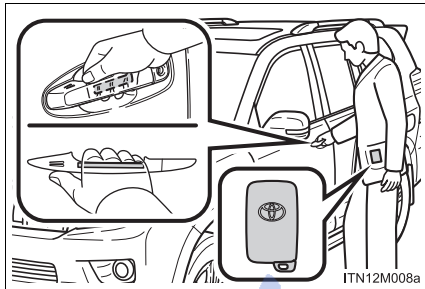

Grip the handle to unlock the doors.

Make sure to touch the sensor on the back of the handle.

The doors cannot be unlocked for 3 seconds after the doors are locked.

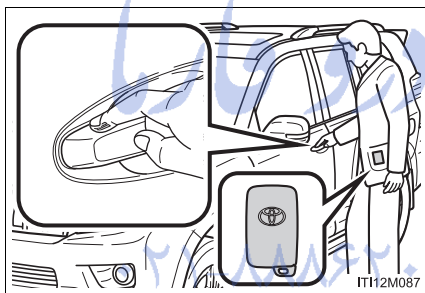

Touch the lock sensor (the indentation on the upper or lower part of the door handle) to lock the doors.

1

Before driving

تلفن شبانه روزی: ۰۲۱۳۳۳۳۳۳۳۳

FarmaSOS.com

Unlocking and locking the back door

Vehicles with back door mounted spare tire

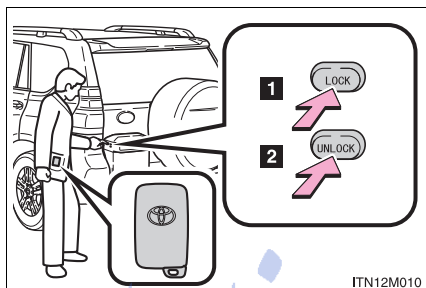

- 1** Locks the all doors
- 2** Unlocks the all doors

The doors cannot be unlocked for 3 seconds after the doors are locked.

Vehicles without back door mounted spare tire

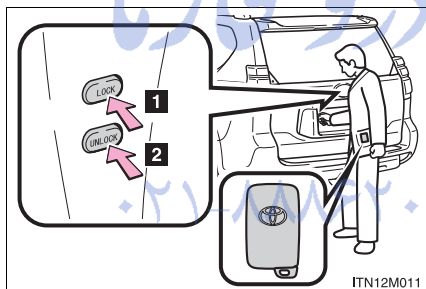

- 1** Locks the all doors
- 2** Unlocks the all doors

The doors cannot be unlocked for 3 seconds after the doors are locked.

تلفن شبانه روزی: ۰۲۱-۸۵۰۰۰۰۰۰۰۰

FarmaSOS.com

Opening the glass hatch

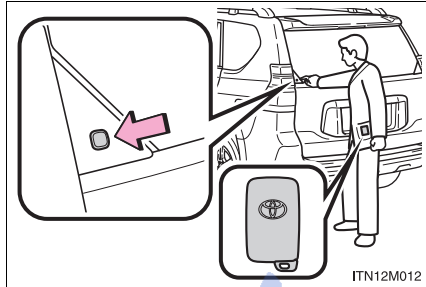

Press the button to open the glass hatch. The glass hatch will pop up.

The glass hatch can be opened only when the back door is closed.

1

Before driving

Antenna location and effective range

■ Antenna location

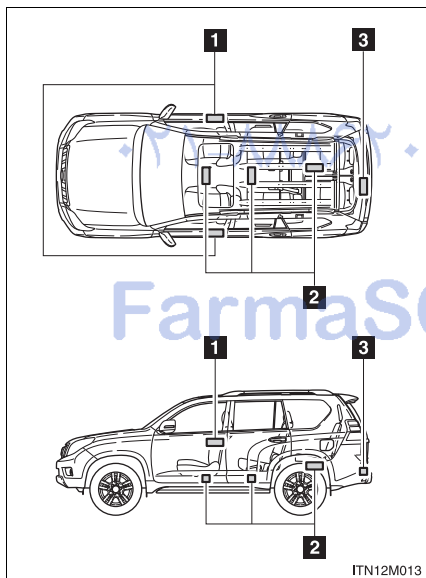

- 1 Antennas outside cabin
- 2 Antennas inside cabin
- 3 Antenna outside luggage compartment

1-2. Opening, closing and locking the doors

■ Effective range (areas within which the electronic key is detected)

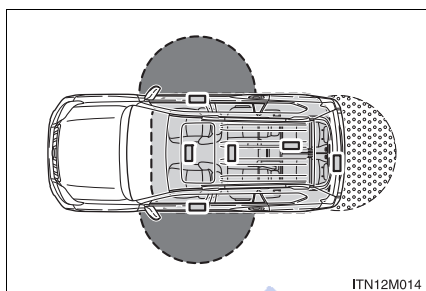

- When locking or unlocking the doors

The system can be operated when the electronic key is within about 0.7 m (2.3 ft.) of either of the outside front door handle.

- When starting the engine or changing “ENGINE START STOP” switch modes

The system can be operated when the electronic key is inside the vehicle.

Vehicles for U.K.: The system may not operate when the back door or the glass hatch are open, even if the electronic key is in the rear of the vehicle.

- When opening the glass hatch (if equipped) and locking or unlocking the back door.

This system can be operated when the electronic key is within about 0.7 m (2.3 ft.) of the back door handle.

■ **Operation signals**

A buzzer* sounds and the emergency flashers flash to indicate that the doors have been locked/unlocked. (Locked: once; Unlocked: twice)

*:For Kazakhstan, Azerbaijan and Georgia

■ **When the door cannot be locked by the lock sensor on the upper part of the door handle**

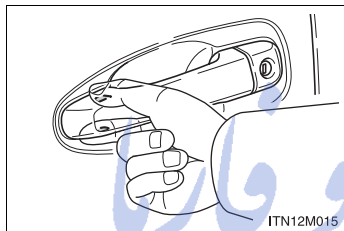

Touch both lock sensors on the upper and lower part of the door handle simultaneously.

1

Before driving

تلفن شبانه روزی: ۰۲۱-۸۸۶۲۰۸۵

FarmaSOS.com

1-2. Opening, closing and locking the doors

■ Alarms and warning indicators

A combination of exterior and interior alarms as well as warning lights and warning messages shown on the multi-information display is used to prevent theft of the vehicle and accidents resulting from erroneous operation.

- When any warning lights come on
Take appropriate measures depending on which warning light comes on. (→P. 712)
- When a warning message is shown on the multi-information display
Take appropriate measures in response to the warning message on the multi-information display. (→P. 730)

Alarm	Situation	Correction procedure
Interior alarm pings once and exterior alarm sounds once for 5 seconds*1	An attempt was made to lock the doors using the entry function while the electronic key was still inside the passenger compartment	Retrieve the electronic key from the passenger compartment and lock the doors again
	An attempt was made to exit the vehicle and lock the doors without first turning the "ENGINE START STOP" switch OFF	Turn the "ENGINE START STOP" switch OFF and lock the doors again
Exterior alarm sounds once for 5 seconds	An attempt was made to lock the vehicle while a door is open	Close all of the doors and lock the doors again
	An attempt was made to close the glass hatch while the electronic key was still inside the passenger compartment	Open the glass hatch again and retrieve the electronic key from the passenger compartment

1-2. Opening, closing and locking the doors

Alarm	Situation	Correction procedure
Interior alarm pings continuously	The "ENGINE START STOP" switch was turned to ACCESSORY mode while the driver's door was open (or the driver's door was opened while the "ENGINE START STOP" switch was in ACCESSORY mode)	Turn the "ENGINE START STOP" switch OFF and close the driver's door
Interior alarm sounds continuously*1	When the "ENGINE START STOP" switch is in IGNITION ON or ACCESSORY mode, an attempt was made to open the door and exit the vehicle, and the shift lever was not in "P"	Shift the shift lever to "P" and turn the "ENGINE START STOP" switch OFF
Interior and exterior alarms sound continuously*1	When the "ENGINE START STOP" switch is in IGNITION ON or ACCESSORY mode, the driver's door was closed after the key was carried outside the vehicle, and the shift lever not in "P"	Shift the shift lever to "P", turn the "ENGINE START STOP" switch OFF and close the driver's door again

1

Before driving

1-2. Opening, closing and locking the doors

Alarm	Situation	Correction procedure
Interior alarm pings once*1	The electronic key has a low battery	Replace the electronic key battery
	An attempt was made to start the engine without the electronic key being present, or the electronic key was not functioning normally	Start the engine with the electronic key present*2
Interior alarm pings once and exterior alarm sounds 3 times*1	The driver's door was closed after the key was carried outside the vehicle, and the "ENGINE START STOP" switch was not turned OFF	Turn the "ENGINE START STOP" switch OFF and close the driver's door again
	An occupant carried the electronic key outside the vehicle and closed the door while the "ENGINE START STOP" switch was not OFF	Bring the electronic key back into the vehicle

*1: A message will be shown on the multi-information display in the instrument cluster.

*2: If the engine does not start when the electronic key is inside the vehicle, the electronic key battery may be depleted or there may be difficulties receiving signal from the key. (→P. 792)

■ **Security feature**





If a door is not opened within approximately 30 seconds after the vehicle is unlocked, the security feature automatically locks the vehicle again.

■ **Switching the door unlock function**

It is possible to set which doors the entry function unlocks.

STEP 1 Turn the “ENGINE START STOP” switch OFF.

STEP 2 Cancel the intrusion sensor and tilt sensor of the alarm system to prevent unintended triggering of the alarm during the setting change. (→P. 162)

STEP 3 When the indicator on the key surface is turned off, press and hold  or  (if equipped) for approximately 5 seconds while pressing  or  on the key.

The setting changes each time an operation is performed, as shown below. (When changing the setting continuously, release the buttons, wait for at least 5 seconds, and repeat **STEP 3**.)

1

Before driving

تلفن شبانه روزی: ۰۲۱-۸۸۶۲۰۸۵

FarmaSOS.com

1-2. Opening, closing and locking the doors

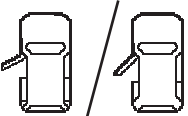
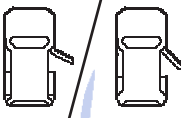
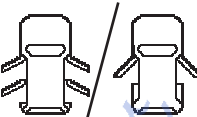
Multi-information display	Unlocking function	Beep
 (Left-hand drive vehicles)	Hold the driver's door handle to unlock only the driver's door.	Exterior: Beeps three times Interior: Pings once
 (Right-hand drive vehicles)	Hold the front passenger's door handle to unlock all doors.	
	Hold either door handle to unlock all doors.	Exterior: Beeps twice Interior: Pings once

STEP 4 Vehicles with alarm system: Unlock the doors using the wireless remote control and open one of the doors.

If a door is not opened within 30 seconds after  is pressed, the doors will be locked again and the alarm will automatically be set. In case that the alarm is triggered, immediately stop the alarm. (→P. 160)

■ Battery-saving function

In the following circumstances, the entry function is disabled in order to prevent the vehicle battery from discharging and the electronic key battery from depleting.

- When the entry function has not been used for 5 days or more
- When the electronic key has been left within approximately 2 m (6 ft.) of the vehicle for 10 minutes or more
- If the entry function has not been used for 14 days or more, the vehicle cannot be unlocked by a door other than the driver's door. To unlock the vehicle, grip the driver's door handle or use the wireless remote control or the mechanical key.

The system will resume operation when:

- The vehicle is locked using the lock sensor when carrying the electronic key on your person.
- The vehicle is locked/unlocked using the wireless remote control. (→P. 66)
- The vehicle is locked/unlocked using the mechanical key. (→P. 791)

■ Conditions affecting operation

The smart entry & start system uses weak radio waves. In the following situations, the communication between the electronic key and the vehicle may be affected, preventing the smart entry & start system, wireless remote control and immobilizer system from operating properly.

(Ways of coping: →P. 791)

1-2. Opening, closing and locking the doors

- When the electronic key battery is depleted
- Near a TV tower, electric power plant, gas station, radio station, large display, airport or other facility that generates strong radio waves or electrical noise
- When carrying a portable radio, cellular phone, cordless phone or other wireless communication devices
- When the electronic key is in contact with, or is covered by the following metallic objects
 - Cards to which aluminum foil is attached
 - Cigarette boxes that have aluminum foil inside
 - Metallic wallets or bags
 - Coins
 - Hand warmers made of metal
 - Media such as CDs and DVDs
- When multiple electronic keys are in the vicinity
- When another wireless key (that emits radio waves) is being used nearby
- When carrying the electronic key together with the following devices that emit radio waves
 - Another vehicle's electronic key or a wireless key that emits radio waves
 - Personal computers or personal digital assistants (PDAs)
 - Digital audio players
 - Portable game systems
- If window tint with a metallic content or metallic objects are attached to the rear window

■ **Note for the entry function**

- Even when the electronic key is within the effective range (detection areas), the system may not operate properly in the following cases:
 - The electronic key is too close to the window or outside door handle, near the ground, or in a high place when the doors are locked or unlocked.
 - The electronic key is near the ground or in a high place, or too close to the rear bumper center when the glass hatch is opened.
 - The electronic key is on the instrument panel, luggage cover or floor, or in the glove box.
- Do not leave the electronic key on top of the instrument panel or near the door pockets when exiting the vehicle. Depending on the radio wave reception conditions, it may be detected by the antenna outside the cabin and the door will become lockable from the outside, possibly trapping the electronic key inside the vehicle.
- As long as the electronic key is within the effective range, the doors may be locked or unlocked by anyone. However, only the doors detecting the electronic key can be used to unlock the vehicle.
- The doors may lock or unlock if the electronic key is within the effective range and a large amount of water splashes on the door handle, such as in the rain or in a car wash. The doors will automatically be locked after approximately 30 seconds if a door is not opened and closed.
- If the wireless remote control is used to lock the doors when the electronic key is near the vehicle, there is a possibility that the door may not be unlocked by the entry function. (Use the wireless remote control to unlock the doors.)

1-2. Opening, closing and locking the doors

■ Note for locking the doors

- Touching the door lock sensor while wearing gloves may delay or prevent lock operation. Remove the gloves and touch the lock sensor again.
- If the door handle becomes wet while the electronic key is within the effective range, the door may lock and unlock repeatedly. Place the key in a position 2 m (6 ft.) or more separate from the vehicle while the vehicle is being washed. (Take care to ensure that the key is not stolen.)
- If the electronic key is inside the vehicle and a door handle becomes wet during a car wash, a message may be shown on the multi-information display and a buzzer will sound outside the vehicle. To turn off the alarm, lock all the doors.
- The lock sensor may not work properly if it comes into contact with ice, snow, mud, etc. Clean the lock sensor and attempt to operate it again, or use the lock sensor on the lower part of the door handle.
- Fingernails may scrape against the door during operation of the door handle.

Be careful not to injure fingernails or damage the surface of the door.

تلفن شبانه روزی: ۰۲۱-۸۸۶۲۰۸۵

FarmaSOS.com

■ **Note for the unlocking function**

- Gripping the door handle when wearing a glove may not unlock the door.
- A sudden approach to the effective range of door handle may prevent the doors from being unlocked. In this case, return the door handle to the original position and check that the doors unlock before pulling the door handle again.
- If there is another electronic key in the detection area, it may take slightly longer to unlock the doors after the door handle is gripped.

■ **When the vehicle is not driven for extended periods**

- To prevent theft of the vehicle, do not leave the electronic key within 2 m (6 ft.) of the vehicle.
- The smart entry & start system can be deactivated in advance. (→P. 849)

■ **To operate the system properly**

Make sure to carry the electronic key when operating the system. Do not get the electronic key too close to the vehicle when operating the system from the outside of the vehicle.

Depending on the position and holding condition of the electronic key, the key may not be detected correctly and the system may not operate properly. (The alarm may go off accidentally, or the door lock prevention may not function.)

■ **If the smart entry & start system does not operate properly**

- Locking and unlocking the doors: Use the mechanical key. (→P. 791)
- Starting the engine: →P. 792

1-2. Opening, closing and locking the doors

■ Electronic key battery depletion

- The standard battery life is 1 to 2 years.
- If the battery becomes low, an alarm will sound in the cabin when the engine stops. (→P. 46)
- As the electronic key always receives radio waves, the battery will become depleted even if the electronic key is not used. The following symptoms indicate that the electronic key battery may be depleted. Replace the battery when necessary. (→P. 656)
 - The smart entry & start system or the wireless remote control does not operate.
 - The detection area becomes smaller.
 - The LED indicator on the key surface does not turn on.
- To avoid serious deterioration, do not leave the electronic key within 1 m (3 ft.) of the following electrical appliances that produce a magnetic field:
 - TVs
 - Personal computers
 - Cellular phones, cordless phones and battery chargers
 - Recharging cellular phones or cordless phones
 - Induction cookers
 - Table lamps

■ When the electronic key battery is fully depleted

→P. 656

■ Customization

Settings (e.g. smart entry & start system) can be changed.
(Customizable features →P. 849)

■ Certification for the smart entry & start system

Hereby, Toyota Motor Corporation, declares that this TMLF8-15 is in compliance with the essential requirements and other relevant provisions of Directive 1999/5/EC.

1

Before driving

TOYOTA

TOYOTA MOTOR CORPORATION

1, TOYOTA-CHO, TOYOTA, AICHI, 471-8571 (Head Office)
or 471-8572 (Research & Development Group) JAPAN
TEL.: +81-565-28-2121

R&TTE Declaration of Conformity

We,

Manufacturer's Name: TOYOTA MOTOR CORPORATION
Manufacturer's Address: 1, Toyota -cho, Toyota, Aichi, 471-8572, Japan

hereby declare under our sole responsibility that the product:

Product Name: LF Oscillator

Product Model: TMLF8-15

to which this declaration relates is in conformity with the essential requirements and other relevant requirements of the R&TTE Directive (1999/5/EC). The product is compliant with the following standards and/or other normative documents:

- Health & safety requirements: EN60950-1
- EMC requirements EN 301 489-01 & EN 301 489-03
- Effective uses of radio spectrum: EN 300 330-2

Supplementary Information:

* CE mark	
* Member states intended for use	EU and EFTA

Date: September 18, 2008

Signature: Takaaki Enomoto
Takaaki Enomoto

1-2. Opening, closing and locking the doors

Hereby, Toyota Motor Corporation, declares that this TMLF8-15 is in compliance with the essential requirements and other relevant provisions of Directive 1999/5/EC.
Toyota Motor Corporation vakuuttaa täten että TMLF8-15 tyyppinen laite on direktiivin 1999/5/EY oleellisten vaatimusten ja sitä koskevien direktiivin muiden ehtojen mukainen.
Hierbij verklaart Toyota Motor Corporation dat het toestel TMLF8-15 in overeenstemming is met de essentiële eisen en de andere relevante bepalingen van richtlijn 1999/5/EG.
Par la présente Toyota Motor Corporation déclare que l'appareil TMLF8-15 est conforme aux exigences essentielles et aux autres dispositions pertinentes de la directive 1999/5/CE.
Härmed intygar Toyota Motor Corporation att denna TMLF8-15 står i överensstämmelse med de väsentliga egenskapskrav och övriga relevanta bestämmelser som framgår av direktiv 1999/5/EG.
Undertegnede Toyota Motor Corporation erklærer herved, at følgende udstyr TMLF8-15 overholder de væsentlige krav og øvrige relevante krav i direktiv 1999/5/EF.
Hiermit erklärt Toyota Motor Corporation, dass sich das Gerät TMLF8-15 in Übereinstimmung mit den grundlegenden Anforderungen und den übrigen einschlägigen Bestimmungen der Richtlinie 1999/5/EG befindet.
ΜΕ ΤΗΝ ΠΑΡΟΥΣΑ Toyota Motor Corporation ΔΗΛΩΝΕΙ ΟΤΙ ΤΜΛF8-15 ΣΥΜΜΟΡΦΩΝΕΤΑΙ ΠΡΟΣ ΤΙΣ ΟΥΣΙΩΔΕΙΣ ΑΠΑΙΤΗΣΕΙΣ ΚΑΙ ΤΙΣ ΛΟΙΠΕΣ ΣΧΕΤΙΚΕΣ ΔΙΑΤΑΞΕΙΣ ΤΗΣ ΟΔΗΓΙΑΣ 1999/5/ΕΚ.
Con la presente Toyota Motor Corporation dichiara che questo TMLF8-15 è conforme ai requisiti essenziali ed alle altre disposizioni pertinenti stabilite dalla direttiva 1999/5/CE.
Por medio de la presente Toyota Motor Corporation declara que el TMLF8-15 cumple con los requisitos esenciales y cualesquiera otras disposiciones aplicables o exigibles de la Directiva 1999/5/CE.
Toyota Motor Corporation declara que este TMLF8-15 está conforme com os requisitos essenciais e outras disposições da Directiva 1999/5/CE.
Hawnhekk, Toyota Motor Corporation, jiddikjara li dan TMLF8-15 jikkonforma mal-htigijiet essenzjali u ma provvedimenti oħrajn rilevanti li hemm fid-Direttiva 1999/5/EC.

1-2. Opening, closing and locking the doors

Käesolevaga kinnitab Toyota Motor Corporation seadme TMLF8-15 vastavust direktiivi 1999/5/EÜ põhinõuetele ja nimetatud direktiivist tulenevatele teistele asjakohastele sätetele.
Alulírott, Toyota Motor Corporation nyilatkozom, hogy a TMLF8-15 megfelel a vonatkozó alapvető követelményeknek és az 1999/5/EC irányelv egyéb előírásainak.
Toyota Motor Corporation týmto vyhlasuje, že TMLF8-15 spĺňa základné požiadavky a všetky príslušné ustanovenia Smernice 1999/5/ES.
Toyota Motor Corporation tímto prohlašuje, že tento TMLF8-15 je ve shodě se základními požadavky a dalšími příslušnými ustanoveními směrnice 1999/5/ES.
Toyota Motor Corporation izjavlja, da je ta TMLF8-15 v skladu z bistvenimi zahtevami in ostalimi relevantnimi določili direktive 1999/5/ES.
Šiuo Toyota Motor Corporation deklaruoja, kad šis TMLF8-15 atitinka esminius reikalavimus ir kitas 1999/5/EB Direktyvos nuostatas.
Ar šo Toyota Motor Corporation deklārē, ka TMLF8-15 atbilst Direktīvas 1999/5/EK būtiskajām prasībām un citiem ar to saistītajiem noteikumiem.
Niniejszym Toyota Motor Corporation oświadcza, że TMLF8-15 jest zgodny z zasadniczymi wymogami oraz pozostałymi stosownymi postanowieniami Dyrektywy 1999/5/EC.
Hér með lýsir Toyota Motor Corporation yfir því að TMLF8-15 er í samræmi við grunnkröfur og aðrar kröfur, sem gerðar eru í tilskipun 1999/5/EC.
Toyota Motor Corporation erklærer herved at utstyret TMLF8-15 er i samsvar med de grunnleggende krav og øvrige relevante krav i direktiv 1999/5/EF.
Ovim, Toyota Motor Corporation, izjavljuje da ovaj TMLF8-15 je usklađen sa bitnim zahtjevima i drugim relevantnim odredbama Direktive 1999/5/EC.

1

Before driving

1-2. Opening, closing and locking the doors

Hereby, Tokai Rika Co., Ltd., declares that this Electronic Key, model B74EA, is in compliance with the essential requirements and other relevant provisions of Directive 1999/5/EC.

TOKAI RIKA

R&TTE Declaration of Conformity

We,

Manufacturer's Name: Tokai Rika Co., Ltd.
Manufacturer's Address: 280, Toyota 3-chome, Oguchi-cho, Niwa-gun, Aichi-ken,
480-0195, Japan

hereby declare under our sole responsibility that the product:

Product Name: Electronic Key
Product Model: B74EA

to which this declaration relates is in conformity with the essential requirements and other relevant requirements of the R&TTE Directive (1999/5/EC). The product is compliant with the following standards and/or other normative documents:

Safety: EN60950-1
EMC: EN301 489-1 & -3
Spectrum: EN300 220-2, EN300 330-2

Supplementary information:

* CE mark	
* Member states intended for use	EU and EFTA
* Member states with restrictive use	None

Date:

8 January 2008

Signature:

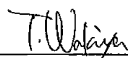

Position of the signatory:

Tadashi Wakiya
General Manager,
Electronics Engineering Div.

Ovim, Tokai Rika Co., Ltd., izjavljuje da ovaj B74EA je usklađen sa bitnim zahtjevima i drugim relevantnim odredbama Direktive 1999/5/EC.

Hereby, Tokai Rika Co., Ltd., declares that this Tuner, model B72UA, is in compliance with the essential requirements and other relevant provisions of Directive 1999/5/EC.

TOKAI RIKA

1

Before driving

R&TTE Declaration of Conformity

We,

Manufacturer's Name: Tokai Rika Co., Ltd.
 Manufacturer's Address: 280, Toyota 3-chome, Oguchi-cho, Niwa-gun, Aichi-ken,
 480-0195, Japan

hereby declare under our sole responsibility that the product:

Product Name: Tuner
 Product Model: B72UA

to which this declaration relates is in conformity with the essential requirements and other relevant requirements of the R&TTE Directive (1999/5/EC). The product is compliant with the following standards and/or other normative documents:

Safety: EN60950-1
 EMC: EN301 489-1 & -3
 Spectrum: EN300 220-2

Supplementary information:

* CE mark	
* Member states intended for use	EU and EFTA
* Member states with restrictive use	None

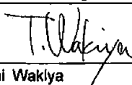
Date: 8 January 2008
 Signature: 
 Position of the signatory: Tadashi Wakiya
 General Manager,
 Electronics Engineering Div.

Ovim, Tokai Rika Co., Ltd., izjavljuje da ovaj B72UA je usklađen sa bitnim zahtjevima i drugim relevantnim odredbama Direktive 1999/5/EC.

1-2. Opening, closing and locking the doors

Hereby, Toyota Motor Corporation, declares that this TMIMB-2 is in compliance with the essential requirements and other relevant provisions of Directive 1999/5/EC.

TOYOTA

TOYOTA MOTOR CORPORATION

1, TOYOTA-CHO, TOYOTA, AICHI, 471-8571 (Head Office)
or 471-8572 (Research & Development Group), JAPAN
TEL: +81-665-28-2121

R&TTE Declaration of Conformity

We,

Manufacturer's Name: TOYOTA MOTOR CORPORATION
Manufacturer's Address: 1, Toyota -cho, Toyota, Aichi, 471-8572, Japan

hereby declare under our sole responsibility that the product:

Product Name: Immobilizer

Product Model: TMIMB-2

to which this declaration relates is in conformity with the essential requirements and other relevant requirements of the R&TTE Directive (1999/5/EC). The product is compliant with the following standards and/or other normative documents:

-Health & safety requirements: EN60950-1
-EMC requirements: EN 301 489-01 & EN 301 489-03
-Effective uses of radio spectrum: EN 300 330-2

Supplementary information:

* CE mark	
* Member states Intended for use	EU and EFTA

Date: January 21, 2008

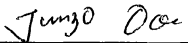
Signature: 
Junzo Ooe

1-2. Opening, closing and locking the doors

Hereby, Toyota Motor Corporation, declares that this TMIMB-2 is in compliance with the essential requirements and other relevant provisions of Directive 1999/5/EC.
Toyota Motor Corporation vakuuttaa täten että TMIMB-2 tyyppinen laite on direktiivin 1999/5/EY oleellisten vaatimusten ja sitä koskevien direktiivin muiden ehtojen mukainen.
Hierbij verklaart Toyota Motor Corporation dat het toestel TMIMB-2 in overeenstemming is met de essentiële eisen en de andere relevante bepalingen van richtlijn 1999/5/EG.
Par la présente Toyota Motor Corporation déclare que l'appareil TMIMB-2 est conforme aux exigences essentielles et aux autres dispositions pertinentes de la directive 1999/5/CE.
Härmed intygar Toyota Motor Corporation att denna TMIMB-2 står i överensstämmelse med de väsentliga egenskapskrav och övriga relevanta bestämmelser som framgår av direktiv 1999/5/EG.
Undertegnede Toyota Motor Corporation erklærer herved, at følgende udstyr TMIMB-2 overholder de væsentlige krav og øvrige relevante krav i direktiv 1999/5/EF.
Hiermit erklärt Toyota Motor Corporation, dass sich das Gerät TMIMB-2 in Übereinstimmung mit den grundlegenden Anforderungen und den übrigen einschlägigen Bestimmungen der Richtlinie 1999/5/EG befindet.
ΜΕ ΤΗΝ ΠΑΡΟΥΣΑ Toyota Motor Corporation ΔΗΛΩΝΕΙ ΟΤΙ ΤΜΙΜΒ-2 ΣΥΜΜΟΡΦΩΝΕΤΑΙ ΠΡΟΣ ΤΙΣ ΟΥΣΙΩΔΕΙΣ ΑΠΑΙΤΗΣΕΙΣ ΚΑΙ ΤΙΣ ΛΟΙΠΕΣ ΣΧΕΤΙΚΕΣ ΔΙΑΤΑΞΕΙΣ ΤΗΣ ΟΔΗΓΙΑΣ 1999/5/ΕΚ.
Con la presente Toyota Motor Corporation dichiara che questo TMIMB-2 è conforme ai requisiti essenziali ed alle altre disposizioni pertinenti stabilite dalla direttiva 1999/5/CE.
Por medio de la presente Toyota Motor Corporation declara que el TMIMB-2 cumple con los requisitos esenciales y cualesquiera otras disposiciones aplicables o exigibles de la Directiva 1999/5/CE.
Toyota Motor Corporation declara que este TMIMB-2 está conforme com os requisitos essenciais e outras disposições da Directiva 1999/5/CE.
Hawnhekk, Toyota Motor Corporation, jiddikjara li dan TMIMB-2 jikkonforma mal-htigijiet essenzjali u ma provvedimenti oħrajn rilevanti li hemm fid-Direttiva 1999/5/EC.

1

Before driving

1-2. Opening, closing and locking the doors

<p>Käesolevaga kinnitab Toyota Motor Corporation seadme TMIMB-2 vastavust direktiivi 1999/5/EÜ põhinõuetele ja nimetatud direktiivist tulenevatele teistele asjakohastele sätetele.</p>
<p>Alulírott, Toyota Motor Corporation nyilatkozom, hogy a TMIMB-2 megfelel a vonatkozó alapvető követelményeknek és az 1999/5/EC irányelv egyéb előírásainak.</p>
<p>Toyota Motor Corporation týmto vyhlasuje, že TMIMB-2 spĺňa základné požiadavky a všetky príslušné ustanovenia Smernice 1999/5/ES.</p>
<p>Toyota Motor Corporation tímto prohlašuje, že tento TMIMB-2 je ve shodě se základními požadavky a dalšími příslušnými ustanoveními směrnice 1999/5/ES.</p>
<p>Toyota Motor Corporation izjavlja, da je ta TMIMB-2 v skladu z bistvenimi zahtevami in ostalimi relevantnimi določili direktive 1999/5/ES.</p>
<p>Šiuo Toyota Motor Corporation deklaruoja, kad šis TMIMB-2 atitinka esminius reikalavimus ir kitas 1999/5/EB Direktyvos nuostatas.</p>
<p>Ar šo Toyota Motor Corporation deklarē, ka TMIMB-2 atbilst Direktīvas 1999/5/EK būtiskajām prasībām un citiem ar to saistītajiem noteikumiem.</p>
<p>Niniejszym Toyota Motor Corporation oświadcza, że TMIMB-2 jest zgodny z zasadniczymi wymogami oraz pozostałymi stosownymi postanowieniami Dyrektywy 1999/5/EC.</p>
<p>Hér með lýsir Toyota Motor Corporation yfir því að TMIMB-2 er í samræmi við grunnkröfur og aðrar kröfur, sem gerðar eru í tilskipun 1999/5/EC.</p>
<p>Toyota Motor Corporation erklærer herved at utstyret TMIMB-2 er i samsvar med de grunnleggende krav og øvrige relevante krav i direktiv 1999/5/EF.</p>
<p>Ovim, Toyota Motor Corporation, izjavljuje da ovaj TMIMB-2 je usklađen sa bitnim zahtjevima i drugim relevantnim odredbama Direktive 1999/5/EC.</p>

 CAUTION

■ **Caution regarding interference with electronic devices**

- People with implanted pacemakers or cardiac defibrillators should maintain a reasonable distance between themselves and the smart entry & start system antennas. (→P. 44)

The radio waves may affect the operation of such devices. If necessary, the entry function can be disabled. Ask any authorized Toyota dealer or repairer, or another duly qualified and equipped professional for details, such as the frequency of radio waves and timing of emitting the radio waves. Then, consult your doctor to see if you should disable the entry function.

- User of any electrical medical device other than implanted pacemakers and implanted cardiac defibrillators should consult the manufacturer of the device for information about its operation under the influence of radio waves.

Radio waves could have unexpected effects on the operation of such medical devices.

Ask any authorized Toyota dealer or repairer, or another duly qualified and equipped professional for details on disabling the entry function.

1

Before driving

FarmaSOS.com

1-2. Opening, closing and locking the doors Wireless remote control

The wireless remote control can be used to lock and unlock the vehicle.

Vehicles with wireless remote control transmitter

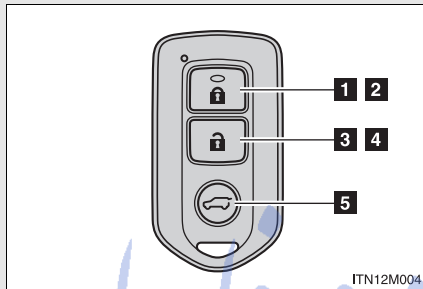

- 1** Locks all the doors
- 2** Closes the windows and moon roof (press and hold)*
- 3** Unlocks all the doors
- 4** Opens the windows and moon roof (press and hold)*
- 5** Opens the glass hatch (press and hold)

The glass hatch can be opened only when the back door is closed.

*: This setting must be customized at any authorized Toyota dealer or repairer, or another duly qualified and equipped professional.

FarmaSOS.com

Vehicles without a smart entry & start system (type A)

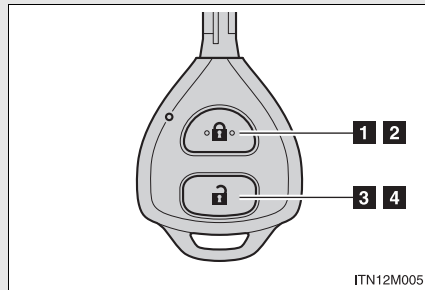

- 1 Locks all the doors
- 2 Closes the windows and moon roof (press and hold)*
- 3 Unlocks all the doors
- 4 Opens the windows and moon roof (press and hold)*

*: This setting must be customized at any authorized Toyota dealer or repairer, or another duly qualified and equipped professional.

Vehicles without a smart entry & start system (type B)

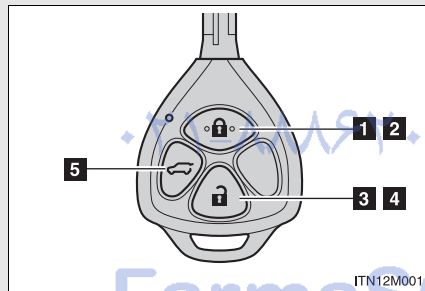

- 1 Locks all the doors
- 2 Closes the windows and moon roof (press and hold)*
- 3 Unlocks all the doors
- 4 Opens the windows and moon roof (press and hold)*
- 5 Opens the glass hatch (press and hold)

The glass hatch can be opened only when the back door is closed.

*: This setting must be customized at any authorized Toyota dealer or repairer, or another duly qualified and equipped professional.

1

Before driving

Vehicles with a smart entry & start system

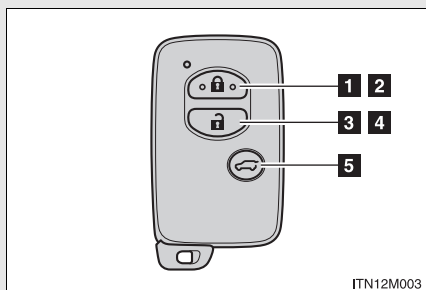

- 1** Locks all the doors
- 2** Closes the windows and moon roof (press and hold)*
- 3** Unlocks all the doors
- 4** Opens the windows and moon roof (press and hold)*
- 5** Opens the glass hatch (press and hold) (vehicles with a glass hatch)

The glass hatch can be opened only when the back door is closed.

*: This setting must be customized at any authorized Toyota dealer or repairer, or another duly qualified and equipped professional.

FarmaSOS.com

■ Operation signals

Doors: A buzzer* sounds and the emergency flashers flash to indicate that the doors have been locked/unlocked. (Locked: Once; Unlocked: Twice)

Windows and moon roof: A buzzer* sounds to indicate that the windows and moon roof are operating.

Glass hatch: A buzzer* sounds once to indicate that the glass hatch have been opened.

*: For Ukraine (2TR-FE engines), Kazakhstan, Azerbaijan and Georgia

■ Door lock buzzer

If an attempt to lock the doors is made when a door is not fully closed, a buzzer sounds continuously for 5 seconds. Fully close the door to stop the buzzer, and lock the vehicle once more.

■ Security feature

If a door is not opened within approximately 30 seconds after the vehicle is unlocked, the security feature automatically locks the vehicle again.

■ Alarm (if equipped)

Using the wireless remote control to lock the doors will set the alarm system.

(→P. 160) * ۲۱-۸۸۶۲۰۸۵ تلفن شبانه روزی

FarmaSOS.com

1-2. Opening, closing and locking the doors

■ Conditions affecting operation

Vehicles without a smart entry & start system

The wireless remote control function may not operate normally in the following situations:

- Near a TV tower, radio station, electric power plant, airport or other facility that generates strong radio waves
- When carrying a portable radio, cellular phone or other wireless communication device
- When multiple wireless keys are in the vicinity
- When the wireless key is in contact with, or is covered by a metallic object
- When a wireless key (that emits radio waves) is being used nearby
- When the wireless key has been left near an electrical appliance such as a personal computer

Vehicles with a smart entry & start system

→P. 51

■ If the wireless remote control does not operate properly (vehicles with a smart entry & start system)

Locking and unlocking the doors: Use the mechanical key. (→P. 791)

FarmaSOS.com

■ **Key battery depletion**

Vehicles without a smart entry & start system

If the wireless remote control function does not operate, the battery may be depleted. Replace the battery when necessary. (→P. 656)

Vehicles with a smart entry & start system

→P. 56

■ **When the electronic key battery is fully depleted**

→P. 656

■ **Customization**

Settings (e.g. wireless remote control system) can be changed.
(Customizable features →P. 849)

■ **Certification for wireless remote control**

Hereby, DENSO CORPORATION declares that this 12BBY/13BDD is in compliance with the essential requirements and other relevant provisions of Directive 1999/5/EC.

1

Before driving

تلفن شبانه روزی: ۰۲۱-۸۸۶۲۰۸۵

FarmaSOS.com

1-2. Opening, closing and locking the doors

Hereby, Tokai Rika Co., Ltd., declares that this Electronic Key, model B74EA, is in compliance with the essential requirements and other relevant provisions of Directive 1999/5/EC.

TOKAI RIKA

R&TTE Declaration of Conformity

We,

Manufacturer's Name: Tokai Rika Co., Ltd.
Manufacturer's Address: 280, Toyota 3-chome, Oguchi-cho, Niwa-gun, Aichi-ken,
480-0195, Japan

hereby declare under our sole responsibility that the product:

Product Name: Electronic Key
Product Model: B74EA

to which this declaration relates is in conformity with the essential requirements and other relevant requirements of the R&TTE Directive (1999/5/EC). The product is compliant with the following standards and/or other normative documents:

Safety: EN60950-1
EMC: EN301 489-1 & -3
Spectrum: EN300 220-2, EN300 330-2

Supplementary information:

* CE mark	
* Member states intended for use	EU and EFTA
* Member states with restrictive use	None

Date:

8 January 2008

Signature:

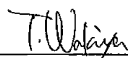

Position of the signatory:

Tadashi Wakiya
General Manager,
Electronics Engineering Div.

Ovim, Tokai Rika Co., Ltd., izjavljuje da ovaj B74EA je usklađen sa bitnim zahtjevima i drugim relevantnim odredbama Direktive 1999/5/EC.

 CAUTION

■ **When closing the windows or moon roof using wireless remote control**

Observe the following precautions. Failing to do so may result in death or serious injury.

- Check to make sure that all passengers do not have any part of their body in a position where it could be caught when a window or moon roof is being operated.
- To prevent inadvertent power windows and moon roof operation, never let a small child have and use the wireless remote control.

■ **Jam protection function**

- Never try jamming any part of your body to activate the jam protection function intentionally.
- The jam protection function may not work if something gets caught just before the window or moon roof fully closes.

1

Before driving

تلفن شبانه روزی: ۰۲۱-۸۸۶۲۰۸۵

FarmaSOS.com

1-2. Opening, closing and locking the doors

Side doors

The vehicle can be locked and unlocked using the entry function, wireless remote control, key or door lock switch.

■ Entry function (if equipped)

→P. 41

■ Wireless remote control

→P. 66

■ Key

Turning the key operates the doors as follows:

Vehicles without a smart entry & start system

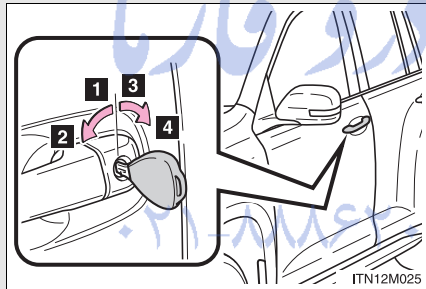

- 1 Locks all the doors
- 2 Closes the windows and moon roof (turn and hold)*
- 3 Unlocks all the doors
- 4 Open the windows and moon roof (turn and hold)*

*: This setting must be customized at any authorized Toyota dealer or repairer, or another duly qualified and equipped professional.

Vehicles with a smart entry & start system

The doors can also be locked and unlocked with the mechanical key. (→P. 791)

■ Door lock switch

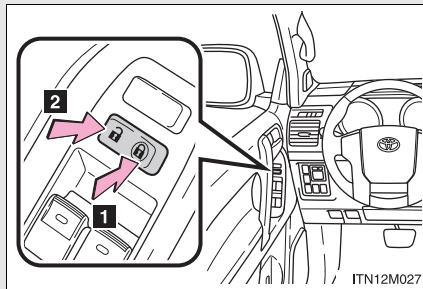

- 1 Locks all the doors
- 2 Unlocks all the doors

■ Inside lock button

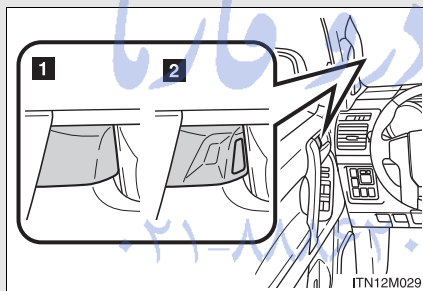

- 1 Locks the door
- 2 Unlocks the door

The driver's door and front passenger's door* can be opened by pulling the inside handle even if the lock button is in the lock position.

*: Except for Ukraine (2TR-FE engines), Kazakhstan, Azerbaijan and Georgia

1

Before driving

1-2. Opening, closing and locking the doors

Locking the front door from the outside without a key

STEP 1 Move the inside lock button to the lock position.

STEP 2 Close the door.

Vehicles without a smart entry & start system

The door cannot be locked if the key is in the engine switch.

Vehicles with a smart entry & start system

The door cannot be locked if the “ENGINE START STOP” switch is in ACCESSORY or IGNITION ON mode, or the electronic key is left inside the vehicle.

The key may not be detected correctly and the door may be locked.

Rear door child-protector lock

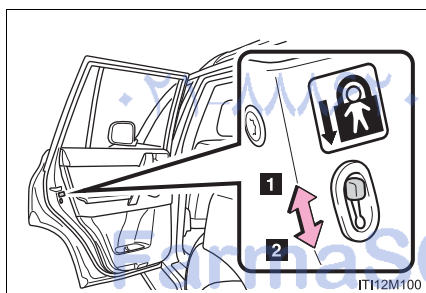

The door cannot be opened from inside the vehicle when the lock is set.

1 Unlock

2 Lock

These locks can be set to prevent children from opening the rear doors. Push down on each rear door switch to lock both rear doors.

Automatic door locking and unlocking systems (if equipped)

The following functions can be set or canceled:

Function	Operation
Shift position linked door locking function *1	Shifting the shift lever out of P locks all the doors.
Shift position linked door unlocking function *1	Shifting the shift lever to P unlocks all the doors.
Speed linked door locking function *1, 2	All the doors are locked when the vehicle speed is approximately 20 km/h (12 mph) or higher.
Driver's door linked door unlocking function *1, 2	All the doors are unlocked when the driver's door is opened within 43 seconds after turning the "ENGINE START STOP" switch off.

*1: GRJ150L-GKAEKW, KDJ150R-GKAEYW, KDJ150L-GKAEYW, KDJ155R-GJAEYW and KDJ155L-GJAEYW models*3

*2: KDJ150R-GKFEYW, KDJ150L-GKFEYW, KDJ155R-GJFEYW and KDJ155L-GJFEYW models*3

*3: The model code is indicated on the manufacturer's label. (→P. 815)

1

Before driving

FarmaSOS.com



1-2. Opening, closing and locking the doors

■ Setting and canceling the functions

To switch between setting and canceling, follow the procedure below.

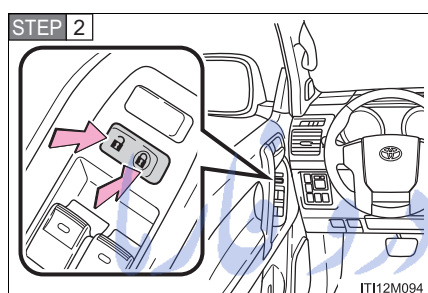
STEP 1 Close all the doors and turn the “ENGINE START STOP” switch to IGNITION ON mode. (Perform step 2 within 20 seconds.)



Shift the shift lever to P or N, and press and hold the driver's door lock switch ( or ) for approximately 5 seconds and then release.





The shift lever and switch positions corresponding to the desired function to be set are shown in the following table.

Use the same procedure to cancel the function.

تلفن شبانه روزی: ۰۲۱-۸۸۶۲۰۸۵

FarmaSOS.com

1-2. Opening, closing and locking the doors

Function	Shift lever position	Driver's door lock switch position
Shift position linked door locking function ^{*1}	P	
Shift position linked door unlocking function ^{*1}		
Speed linked door locking function ^{*1, 2}	N	
Driver's door linked door unlocking function ^{*1, 2}		

1

Before driving

*1: GRJ150L-GKAEKW, KDJ150R-GKAEYW, KDJ150L-GKAEYW, KDJ155R-GJAEYW and KDJ155L-GJAEYW models^{*3}

*2: KDJ150R-GKFEYW, KDJ150L-GKFEYW, KDJ155R-GJFEYW and KDJ155L-GJFEYW models^{*3}

*3: The model code is indicated on the manufacturer's label. (→P. 815)

When the setting or canceling operation is complete, all the doors are locked and then unlocked.

تلفن شبانه روزی: ۰۲۱-۸۸۶۲۰۸۵

FarmaSOS.com

■ **Impact detection door lock release system (if equipped)**

In the event that the vehicle is subject to a strong impact, all the doors are unlocked. Depending on the force of the impact or the type of accident, however, the system may not operate.

■ **Using the mechanical key (vehicles with a smart entry & start system)**

The doors can also be locked and unlocked with the mechanical key.
(→P. 791)

■ **Customization**

Settings (e.g. unlocking function using a key) can be changed.
(Customizable features →P. 849)

 **CAUTION**

■ **To prevent an accident**

Observe the following precautions while driving the vehicle.
Failing to do so may result in a door opening and an occupant falling out, resulting in death or serious injury.

- Always use a seat belt.
- Ensure that all the doors are properly closed.
- Do not pull the inside handle of the doors while driving.
The doors may be opened and the passengers are thrown out of the vehicle and it may result in death or serious injury.
Be especially careful for the front doors, as the doors may be opened even if the inside lock buttons are in locked position.
- Set the rear door child-protector locks when children are seated in the second seat.

1-2. Opening, closing and locking the doors

Back door

The back door can be locked/unlocked and opened the following procedures.

■ Locking and unlocking the back door

Entry function (if equipped)

→P. 42

Wireless remote control

→P. 66

Door lock switch

→P. 75

Inside lock button (vehicles with longitudinal type third seats)

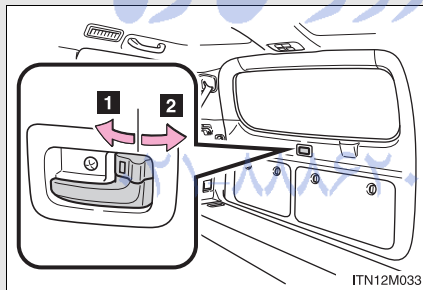

1 Locks the door

2 Unlocks the door

1

Before driving

FarmaSOS.com

■ Opening the back door from outside the vehicle

Vehicles with back door mounted spare tire

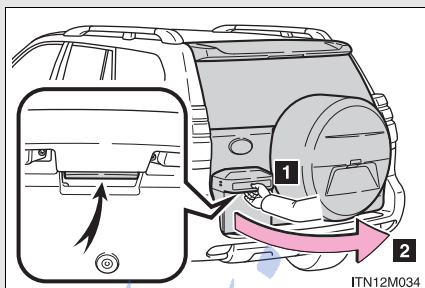

- 1 Pull the handle
- 2 Open the back door

The back door can be kept open at a desired position.

Vehicles without back door mounted spare tire

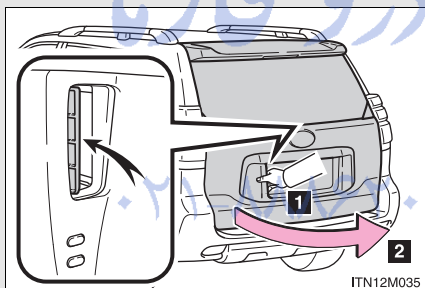

- 1 Pull the handle
- 2 Open the back door

The back door can be kept open at a desired position.

■ Keeping the back door open

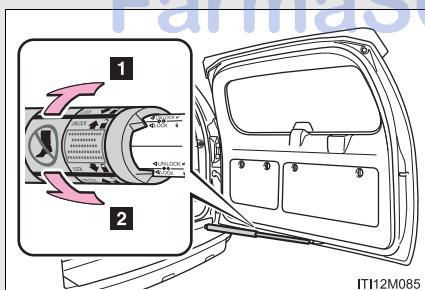

- 1 Unlocks the back door stopper
- 2 Locks the back door stopper

The back door stopper can only be operated when the back door is fully open.

When closing the back door, check that the back door stopper is unlocked.

Back door child-protector lock (vehicles with longitudinal type third seats)

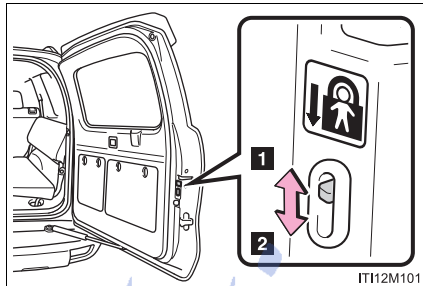

The door cannot be opened from inside the vehicle when the lock is set.

- 1** Unlock
- 2** Lock

This lock can be set to prevent children from opening the back door. Push down on back door switch to lock back door.

1

Before driving

Rear step bumper

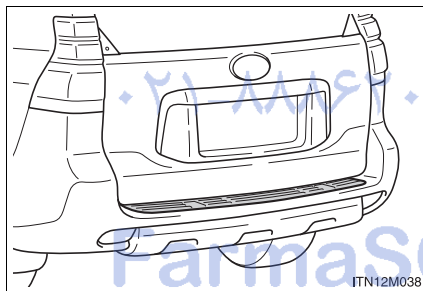

The rear step bumper is for rear end protection and easier step-up loading.

 CAUTION

■ **While driving**

- Keep the back door closed while driving.
If the back door is left open, it may hit near-by objects while driving or luggage may be unexpectedly thrown out, causing an accident.
In addition, exhaust gases may enter the vehicle, causing death or a serious health hazard. Make sure to close the back door before driving.
- Before driving the vehicle, make sure that the back door is fully closed. If the back door is not fully closed, it may open unexpectedly while driving, causing an accident.
- Never let anyone sit in the luggage compartment. In the event of sudden braking, sudden swerving or a collision, they are susceptible to death or serious injury.

■ **When children are in the vehicle**

Observe the following precautions.

Failure to do so may result in death or serious injury.

- Do not leave children alone in the luggage compartment.
If a child is accidentally locked in the luggage compartment, they could have heat exhaustion.
- Do not allow a child to open or close the back door.
Doing so may cause the back door to operate unexpectedly, or cause the child's hands, head, or neck to be caught by the closing back door.

⚠ CAUTION

■ Operating the back door

Observe the following precautions.

Failure to do so may cause parts of the body to be caught, resulting in serious injury.

- When opening or closing the back door, thoroughly check to make sure the surrounding area is safe.
- If anyone is in the vicinity, make sure they are safe and let them know that the back door is about to open or close.
- Use caution when opening or closing the back door in windy weather as it may move abruptly in strong wind.

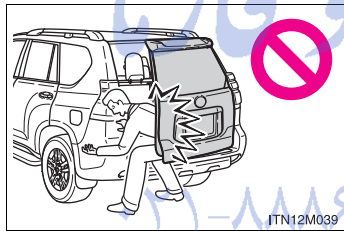

- The back door may close if the back door stopper is not locked (specifically, when using the luggage compartment with the back door kept open at your desired position). It is more difficult to open or close the back door on an incline than on a level surface, so beware of the back door unexpectedly opening or closing by itself. Make sure that the back door stopper is locked and secure when using the luggage compartment.

FarmaSOS.com

1-2. Opening, closing and locking the doors

CAUTION

■ Operating the back door

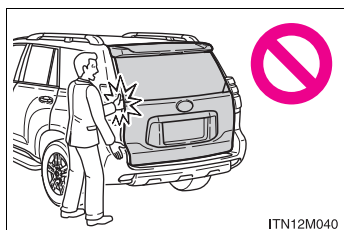

- When closing the back door, take extra care to prevent your fingers etc. from being caught.
- When closing the back door, make sure to press it lightly on its outer surface. If the back door handle is used to fully close the back door, it may result in hands or arms being caught.
- Do not pull on the back door damper stay to close the back door, and do not hang on the back door damper stay. Doing so may cause hands to be caught or the back door damper stay to break, causing an accident.
- Do not attach any accessories other than genuine Toyota parts to the back door. Such additional weight on the back door may cause the back door to fall closed again after it is opened.

تلفن شبانه روری: ۰۲۱-۸۸۶۲۰۸۵
FarmaSOS.com

 NOTICE

■ **Back door damper stay**

The back door is equipped with damper stay that hold the back door in place.

Observe the following precautions.

Failure to do so may cause damage to the back door damper stay, resulting in malfunction.

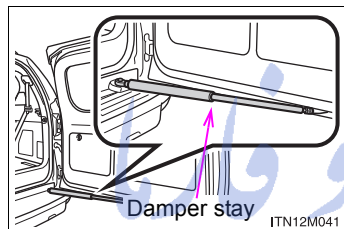

- Do not attach any accessories other than genuine Toyota parts to the back door.
- Do not lean against, climb on or place luggage on the damper stay, or apply lateral forces to it.

1

Before driving

تلفن شبانه روزی: ۰۲۱-۸۸۶۲۰۸۵

FarmaSOS.com

1-2. Opening, closing and locking the doors

Glass hatch*

The glass hatch can be opened using the glass hatch opener or wireless remote control.

■ **Entry function (vehicles with a smart entry & start system)**

→P. 43

■ **Wireless remote control**

→P. 66

■ **Glass hatch opener**

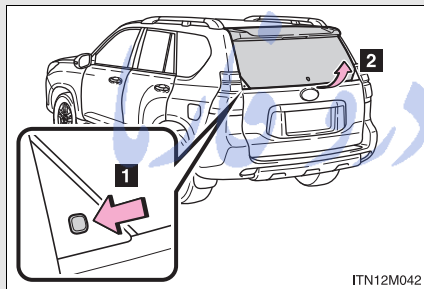

1 Press the button to pop up the glass hatch.

2 Raise

The glass hatch can be opened only when the back door is closed.

The glass hatch cannot be opened when the back door is locked. Unlock the back door to open the glass hatch. (→P. 81)

FarmaSOS.com

*: If equipped

■ **When opening the glass hatch**

- Open the glass hatch slowly and carefully.
- Use the glass hatch opener when the back door is closed.

■ **Opening the glass hatch while the rear window wiper is in operation**

Rear window wiper operation will stop moving. Operation will recommence after the glass hatch has been closed.

■ **Function to prevent the glass hatch being locked with the electronic key inside (vehicles with a smart entry & start system)**

- When all doors are being locked, closing the glass hatch with the electronic key left inside the luggage compartment will sound an alarm. In this case, the glass hatch can be opened using the entry function.
- Even when the spare electronic key is put in the luggage compartment with all the doors locked, the key confinement prevention function can be activated so the glass hatch can be opened. In order to prevent theft, take all electronic keys with you when leaving the vehicle.
- Even when the electronic key is put in the luggage compartment with all the doors are locked, the key may not be detected depending on the places and the surrounding radio wave conditions. In this case, the key confinement prevention function cannot be activated, causing the doors to lock when the glass hatch is closed. Make sure to check where the key is before closing the glass hatch.

■ **After closing the glass hatch**

Check that the glass hatch is firmly closed. If it is not firmly closed, the rear window wiper and washer will not operate correctly.

 CAUTION

■ **While driving**

- Keep the glass hatch closed while driving.
If the glass hatch is left open, it may hit near-by objects while driving or luggage may be unexpectedly thrown out, causing an accident.
In addition, exhaust gases may enter the vehicle, causing death or a serious health hazard. Make sure to close the glass hatch before driving.
- Before driving the vehicle, make sure that the glass hatch is fully closed. If the glass hatch is not fully closed, it may open unexpectedly while driving, causing an accident.

■ **When children are in the vehicle**

Do not allow a child to open or close the glass hatch.
Doing so may cause the glass hatch to operate unexpectedly, or cause the child's hands, head, or neck to be caught by the closing glass hatch.

■ **Operating the glass hatch**

Observe the following precautions.
Failure to do so may cause parts of the body to be caught, resulting in serious injury.

- Remove any heavy loads, such as snow and ice, from the glass hatch before opening it. Failure to do so may cause the glass hatch fall closed again after it is opened.
- When opening or closing the glass hatch, thoroughly check to make sure the surrounding area is safe.
- If anyone is in the vicinity, make sure they are safe and let them know that the glass hatch is about to open or close.
- Use caution when opening or closing the glass hatch in windy weather as it may move abruptly in strong wind.

CAUTION

■ **Operating the glass hatch**

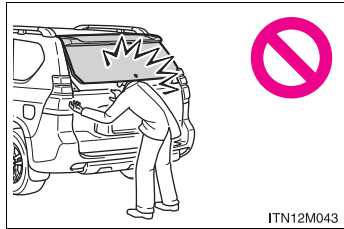

- The glass hatch may fall if it is not opened fully. It is more difficult to open or close the glass hatch on an incline than on a level surface, so beware of the glass hatch unexpectedly opening or closing by itself. Make sure that the glass hatch is fully open and secure when using the luggage compartment.

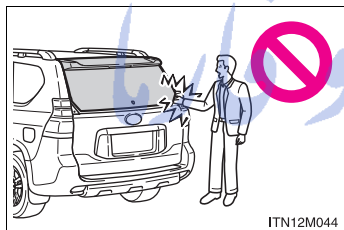

- When closing the glass hatch, take extra care to prevent your fingers etc. from being caught.
- When closing the glass hatch, make sure to press it lightly on its outer surface.

- Do not pull on the glass hatch damper stay to close the glass hatch, and do not hang on the glass hatch damper stay. *تلفن شبانه روزی*
Doing so may cause hands to be caught or the glass hatch damper stay to break, causing an accident.
- Do not attach any accessories other than genuine Toyota parts to the glass hatch. Such additional weight on the glass hatch may cause the glass hatch to fall closed again after it is opened.

 NOTICE

■ **Glass hatch damper stays**

The glass hatch is equipped with damper stays that hold the glass hatch in place.

Observe the following precautions.

Failure to do so may cause damage to the glass hatch damper stay, resulting in malfunction.

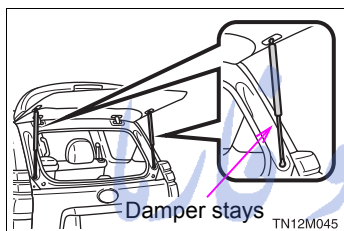

- Do not attach any foreign objects, such as strikers, plastic sheets, or adhesives to the damper stay rod.
- Do not touch the damper stay rod with gloves or other fabric items.
- Do not attach any accessories other than genuine Toyota parts to the glass hatch.
- Do not place your hand or foot on the damper stay or apply lateral forces to it.

تلفن شبانه روزی: ۰۲۱-۸۸۶۲۰۸۵

FarmaSOS.com

1-3. Adjustable components (seats, mirrors, steering wheel) Front seats

Manual seat

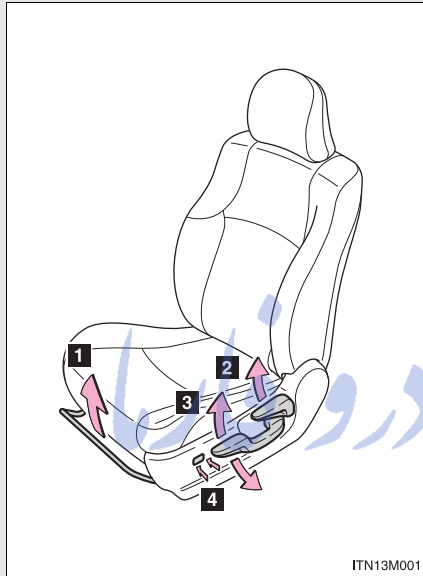

- 1 Seat position adjustment lever
- 2 Seatback angle adjustment lever
- 3 Vertical height adjustment lever (driver's side only)
- 4 Lumbar support adjustment switch (driver's side only)

1

Before driving

امداد خودرو
تلفن شبانه روزی: ۰۲۱-۸۸۸۶۲۰۸۵
FarmaSOS.com

1-3. Adjustable components (seats, mirrors, steering wheel)

Power seat

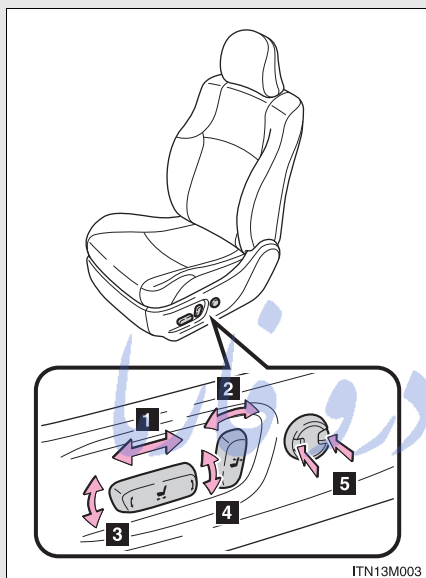

- 1** Seat position adjustment switch
- 2** Seatback angle adjustment switch
- 3** Seat cushion (front) angle adjustment switch (driver's side only)
- 4** Vertical height adjustment switch (driver's side only)
- 5** Lumbar support adjustment switch (driver's side only)

Active head restraints

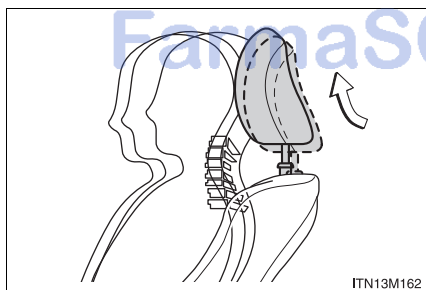

When the occupant's lower back presses against the seatback during a rear-end collision, the head restraint moves slightly forward and upward to help reduce the risk of whiplash on the seat occupant.

Moving a front passenger's seat for second seat access (3-door models)

■ **Getting in the vehicle**

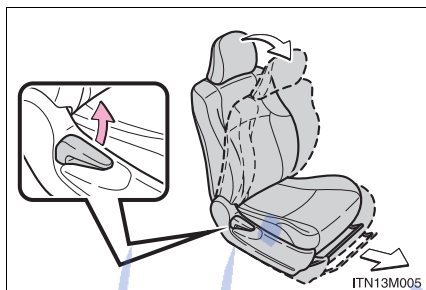

Pull the seatback angle adjustment lever and fold down the seatback. The seat will slide forward.

Move the seat to the front-most position

■ **Getting out of the vehicle**

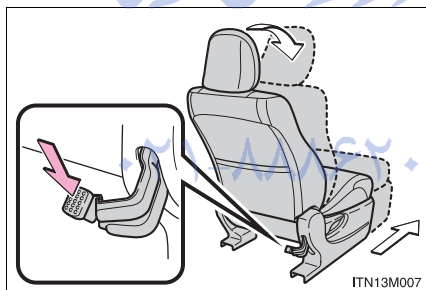

Depress the release pedal and fold down the seatback. The seat will slide forward.

Move the seat to the front-most position

Make sure that no passenger is seated on the front passenger seat before depressing the release pedal.

■ **After passengers have entered/exited the vehicle**

Lift up the seatback and slide the seat backward until it locks.

1

Before driving

■ Active head restraints

Even small forces applied to the seatback may cause the head restraint to move. Pushing up a locked head restraint forcibly may appear the head restraint inner structure. These do not indicate problems.

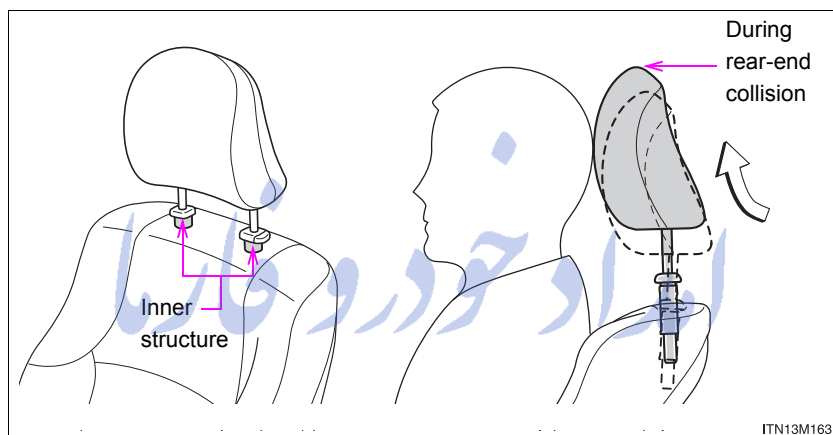

⚠ CAUTION

■ Seat adjustment

- To reduce the risk of sliding under the lap belt during a collision, do not recline the seat more than necessary. If the seat is too reclined, the lap belt may slide past the hips and apply restraint forces directly to the abdomen, or your neck may contact the shoulder belt, increasing the risk of death or serious injury in the event of an accident. Adjustments should not be made while driving as the seat may unexpectedly move and cause the driver to lose control of the vehicle.
- After adjusting the seat, make sure that the seat is locked in position. (manual seat only)

1-3. Adjustable components (seats, mirrors, steering wheel) Rear seats*

Second seats (3-door models)

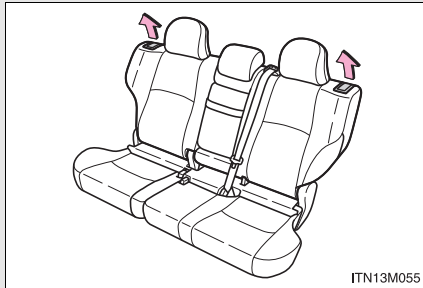

Seatback angle adjustment lever

Second seats (5-door models without third seats and vehicles with longitudinal type seats)

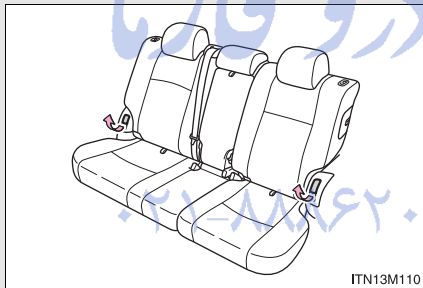

Seatback angle adjustment lever

Second seats (5-door models with third manual/power seats)

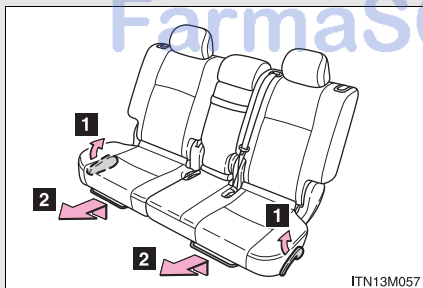

1 Seatback angle adjustment lever

2 Seat position adjustment lever

1

Before driving

*: If equipped

1-3. Adjustable components (seats, mirrors, steering wheel)

Third seats (longitudinal type seat)

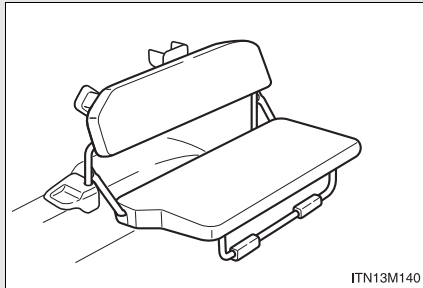

Third seats (manual seat)

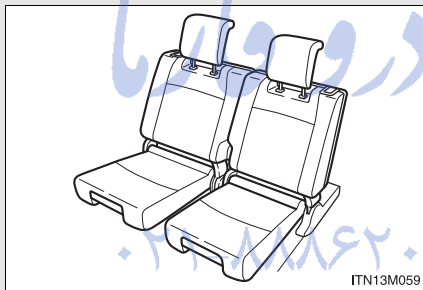

Third seats (power seat)

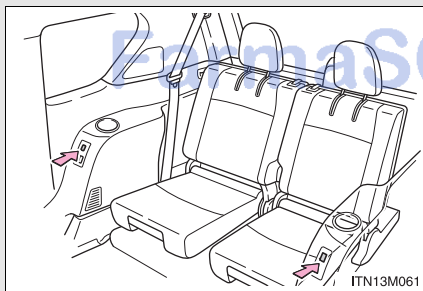

Seatback angle adjustment switch

Moving a second seat for third seat access (5-door models with third manual/power seats)

- **Getting in the vehicle (right side only [left-hand drive vehicles] or left side only [right-hand drive vehicles])**

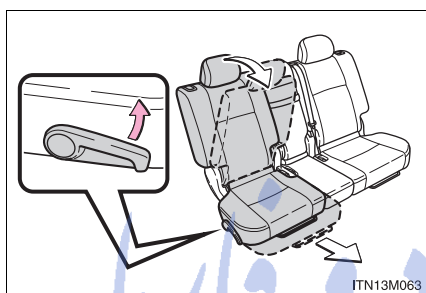

Pull the seatback angle adjustment lever and fold down the seatback. The seat will slide forward.

Move the seat to the front-most position

- **Getting out of the vehicle**

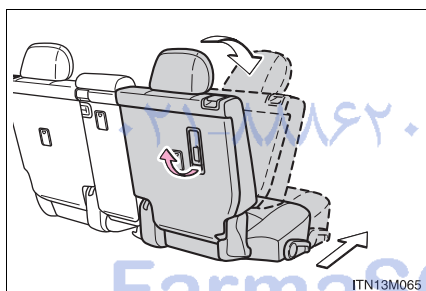

Pull the release lever and fold down the seatback. The seat will slide forward.

Move the seat to the front-most position

Make sure that no passenger is seated on the second seat before pulling the release lever.

- **After passengers have entered/exited the vehicle**

Lift up the seatback and slide the seat backward until it locks.

1

Before driving

Tumbling the second seats (3-door models)

■ Before tumbling the second seats

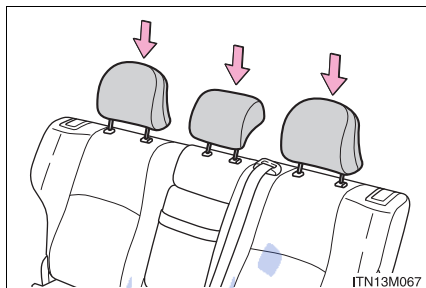

Lower the head restraints to the lowest position.

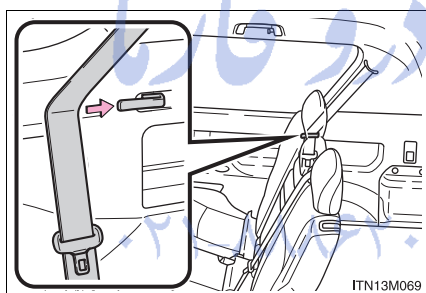

Use the seat belt hangers to prevent the belts from being tangled.

FarmaSOS.com

■ **Tumbling the second seats**

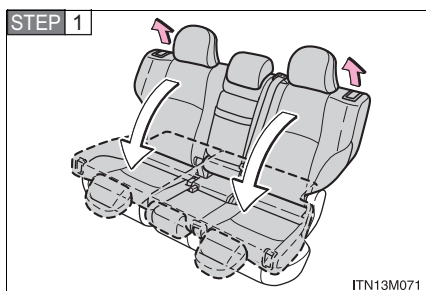

Pull the seatback angle lever and fold them down.

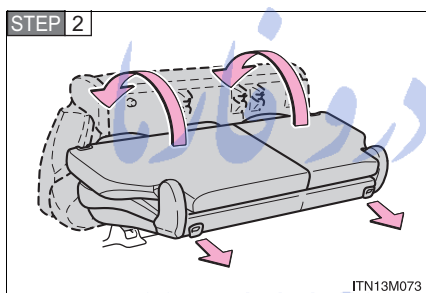

Pull the seat lock release lever on the back and swing the whole seat up and forward.

■ **Returning the second seats**

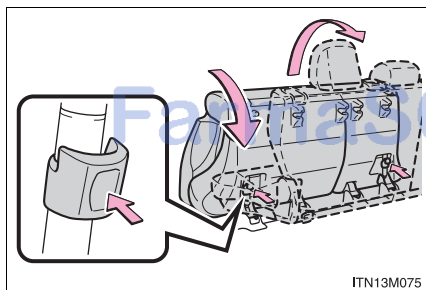

Push the knob to unlock the seat, swing the whole seat down and swing the seatback up.

1

Before driving

Folding down the second seatbacks (5-door models without third seats and vehicles with longitudinal type seats)

■ **Before folding down the second seatbacks**

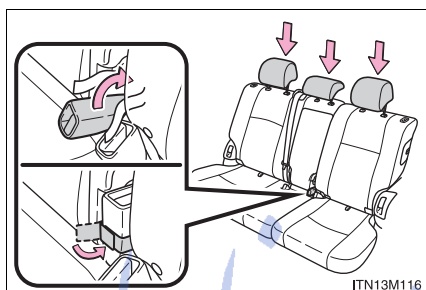

Stow the center seat belt buckle with the hook-and-loop fastener and lower the head restraints to the lowest position.

■ **Folding down second seatbacks**

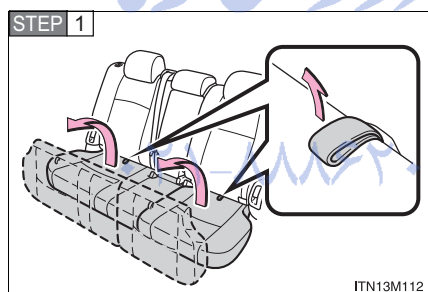

Swing the bottom cushion up by pulling the lock release strap.

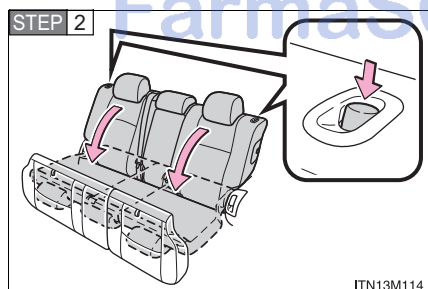

Push the seatback lock release button and fold them down.

To return the second seatbacks to their original positions, lift them up until they lock.

Folding down the second seatbacks (5-door models with third manual/power seats)

■ **Before folding down the second seatbacks**

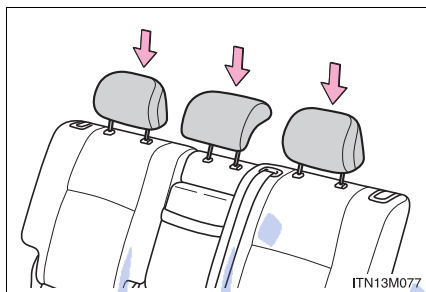

Lower the head restraints to the lowest position.

■ **Folding down second seatbacks**

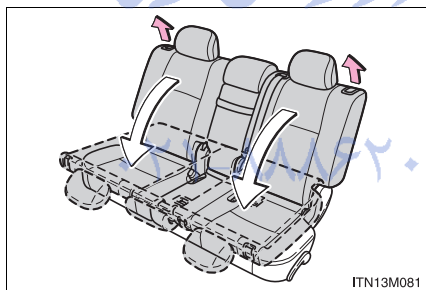

Pull the seatback lock release lever and fold them down.

To return the second seatbacks to their original positions, lift them up until they lock.

1

Before driving

FarmaSOS.com

■ **Folding down second center seatback only (5-door models)**

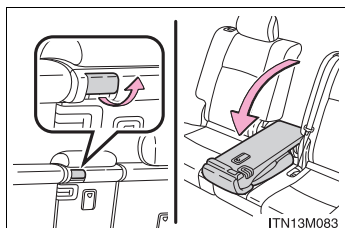

Pull the center seatback lock release lever behind the seatback and fold it down.

To return the center seatback to its original position, lift it up until it locks.

■ **If you cannot raise the second seatback**

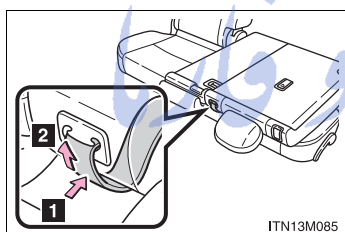

Release the seat belt lock by:

- 1 Pushing on the lower front edge of the seatback to slacken the seat belt.
- 2 Let the seat belt retract a little.

تلفن شبانه روزی: ۰۲۱-۸۸۶۲۰۸۵

FarmaSOS.com

Fold down the third seats (longitudinal type seat)

■ Folding the third seats

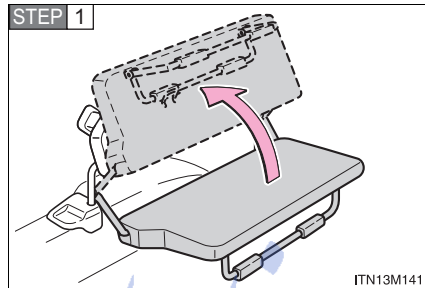

Swing the seat cushion fully up.

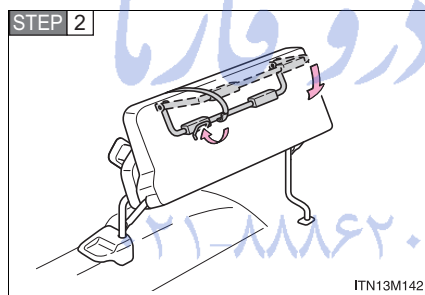

Take the holding strap of its pocket on the back of the seat-back and secure the seat hooking the strap onto the hook in the back of the seat cushion.

■ Returning the third seats

Reverse the steps above.

1

Before driving

FarmaSOS.com

Folding down the third seats (manual seat)

■ Before folding down the third seats

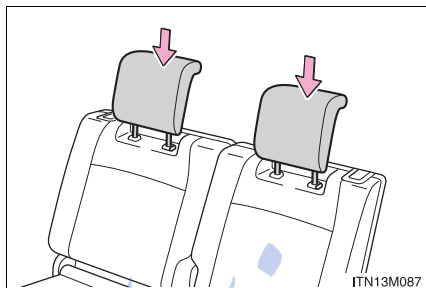

Lower the head restraints to the lowest position.

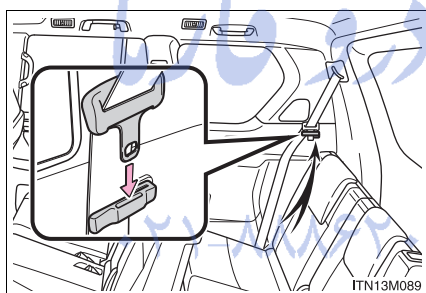

Use the seat belt hangers to prevent the belts from being tangled.

تلفن شبانه روزی: ۸۵

FarmaSOS.com

■ **Folding down the third seats**

From back door side

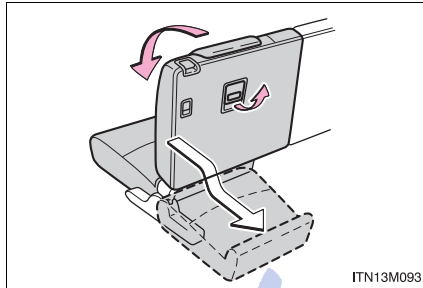

Pull the seat cushion/seatback lock release lever and fold seat-back down.

The seat cushion is stowed automatically.

From rear door side

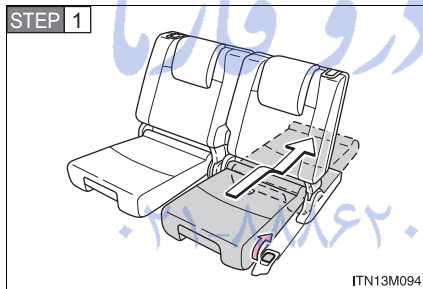

Pull the seat cushion lock release lever.

The seat cushion is stowed automatically.

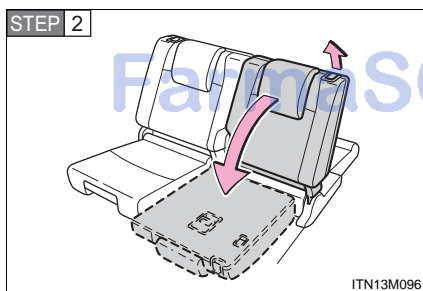

Pull the seatback lock release lever and fold them down.

1

Before driving

1-3. Adjustable components (seats, mirrors, steering wheel)

■ Returning the third seats

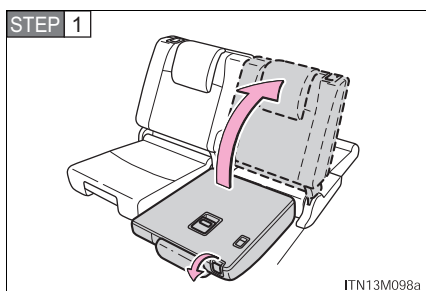

While inside the vehicle, unlock the seatbacks by pulling the lock release lever, and lift them up until they lock.

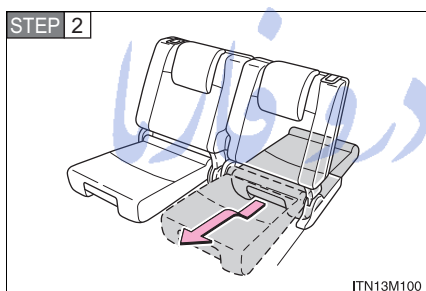

Pull the grip and carry the seat cushions out.

تلفن شبانه روزی: ۰۲۱-۸۸۶۲۰۸۵

FarmaSOS.com

Folding down the third seats (power seat)

Left-hand drive vehicles

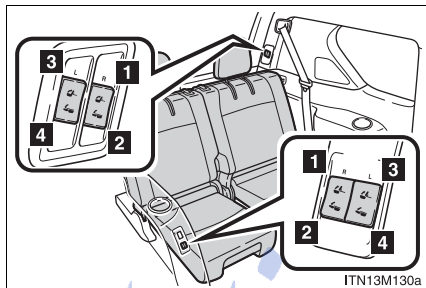

- 1 R: Right seat return switch
- 2 R: Right seat fold switch
- 3 L: Left seat return switch
- 4 L: Left seat fold switch

The switches can be operated from both the rear door side and the back door side.

Right-hand drive vehicles

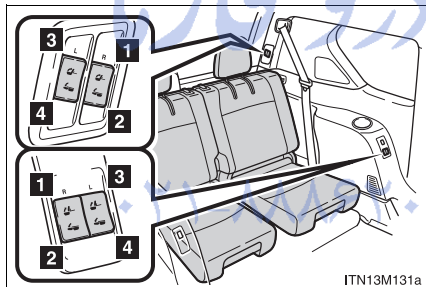

- 1 R: Right seat return switch
- 2 R: Right seat fold switch
- 3 L: Left seat return switch
- 4 L: Left seat fold switch

The switches can be operated from both the rear door side and the back door side.

1

Before driving

1-3. Adjustable components (seats, mirrors, steering wheel)

■ Before folding down the third seats

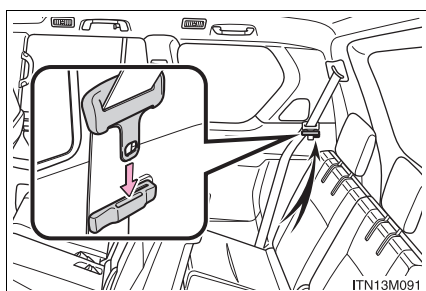

Use the seat belt hangers to prevent the belts from being tangled.

■ Folding down the third seats

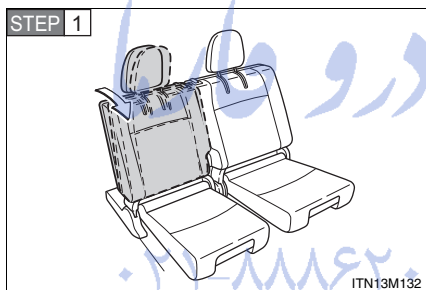

Press and hold . Two beeps sound and the seatback will rise.

When operating is completed, two beeps sound again.

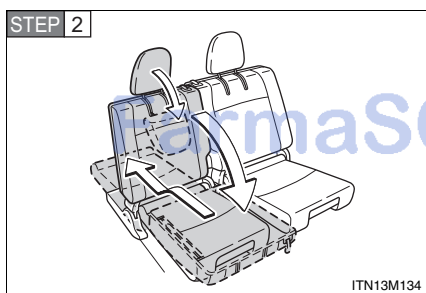



Press and hold  again.

Two beeps sound, the head restraints will fold forward, and the seat will be stowed.

When operating is completed, two beeps sound again.

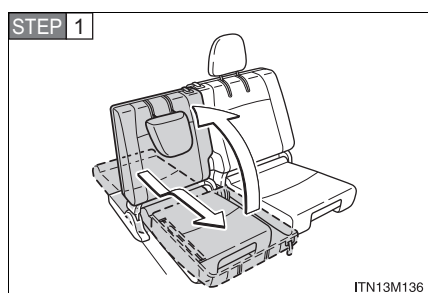
■ Returning the third seats



Press and hold . Two beeps sound and seatback and seat cushion begin to move. When operating is completed, two beeps sound again.

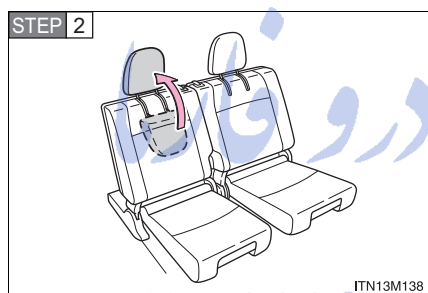

Lift the head restraints up until they lock.

1

Before driving

■ The third power seats can be operated when

- The “ENGINE START STOP” switch is off.
- The shift lever is in P position (vehicles with an automatic transmission) or the parking brake is applied (vehicles with a manual transmission) with the “ENGINE START STOP” switch in IGNITION ON mode.

■ During third power seat stowing operation

Do not remove your hand from the switch until the operation stops automatically. If you remove your hand from the switch, the operation will stop and the buzzer will sound continuously. The buzzer will stop when the switch is pressed again.

■ **Enlarging the luggage compartment (vehicles with third power seats)**

The third seat can be used for sitting when it is in the position shown in **STEP 2** of the folding down the third seats. (→P. 109)

This can be convenient for enlarging the luggage compartment, for instance when the luggage is against the back of the seatback.

■ **If the warning buzzer sounds continuously (vehicles with third power seats)**

If there is an abnormality in the system, the warning buzzer will sound continuously while the “ENGINE START STOP” switch is in IGNITION ON mode. In this case, perform the following operations:



STEP 1 Press and hold  to return the seat.

STEP 2 Press and hold  to stow the seat.

For each step, wait until the seat movement stops automatically and the two beeps sound twice before removing your hand from the switch.

If the warning buzzer does not stop even after performing the above procedure correctly, perform the following operations:

STEP 3 Press and hold  on the rear door side.

STEP 4 While holding , press forward on  5 times within 10 seconds and keep holding  until 3 beeps sound. The beep will then sound continuously again.

STEP 5 Repeat **STEP 1** and **STEP 2**.

 CAUTION

■ **When folding the seatbacks down**

Observe the following precautions. Failure to do so may result in death or serious injury.

- Do not fold the seatbacks down while driving.
- Stop the vehicle on level ground, set the parking brake and shift the shift lever to P (automatic transmission) or 1 (manual transmission).
- Do not allow anyone to sit on a folded seatback or in the luggage compartment while driving.
- Do not allow children to enter the luggage compartment.

■ **Seat adjustment**

- To reduce the risk of sliding under the lap belt during a collision, do not recline the seat more than necessary.

If the seat is too reclined, the lap belt may slide past the hips and apply restraint forces directly to the abdomen, or your neck may contact the shoulder belt, increasing the risk of death or serious injury in the event of an accident.

Adjustments should not be made while driving as the seat may unexpectedly move and cause the driver to lose control of the vehicle.

- Be careful not to get hands or feet pinched between the rear console box and the second seat when folding down the rear seatback.

1

Before driving

FarmaSOS.com

1-3. Adjustable components (seats, mirrors, steering wheel)

CAUTION

■ When stowing the third seats

Observe the following precautions. Failure to do so may result in death or serious injury.

- Check that there is no luggage and that there are no other people around the seat before stowing operation.
- Conduct the procedure slowly and carefully (vehicles with manual third seats).
- Do not insert hands or feet into the moving parts of the seat.
- Do not allow children to operate the seat.
- Do not use the seat if only the seat cushion has been stowed (vehicles with manual third seats).

■ After returning the seatbacks to the upright position

Observe the following precautions. Failure to do so may result in death or serious injury.

- Make sure the seatback is securely locked by pushing it forward and rearward on the top.
- Check that the seat belts are not twisted or caught in the seatback.

NOTICE

■ When returning the third seat (vehicles with a luggage cover)

If the luggage cover is installed in the luggage compartment, make sure you remove it before returning the third seat. (→P. 603) The luggage cover may be damaged by the seat.

1-3. Adjustable components (seats, mirrors, steering wheel) Driving position memory (driver's seat)*

Your preferred driving position (the position of the driver's seat and steering wheel) can be memorized and recalled with the touch of a button. It is also possible to set this function to activate automatically when the driver's door is unlocked. (vehicles with a smart entry & start system)

Two different driving positions can be entered into memory.

■ Entering a position to memory

STEP 1 Vehicles with an automatic transmission

Check that the shift lever is in P.

Vehicles with a manual transmission

Check that the parking brake is set.

STEP 2 Vehicles without a smart entry & start system

Turn the engine switch to the "ON" position.

Vehicles with a smart entry & start system

Turn the "ENGINE START STOP" switch to IGNITION ON mode.

STEP 3 Adjust the driver's seat and steering wheel to the desired positions.

1

Before driving

FarmaSOS.com

*: If equipped

1-3. Adjustable components (seats, mirrors, steering wheel)

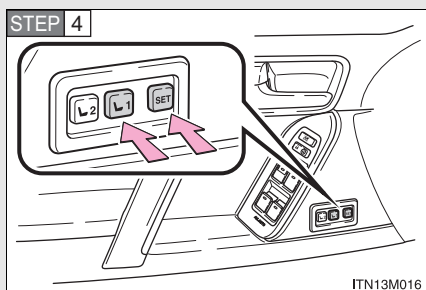

While pressing the “SET” button, or within 3 seconds after the “SET” button is pressed, press button 1 or 2 until the signal beeps.

If the selected button has already been preset, the previously recorded position will be overwritten.

■ Recalling the memorized position

STEP 1 Vehicles with an automatic transmission

Check that the shift lever is in P.

Vehicles with a manual transmission

Check that the parking brake is set.

STEP 2 Vehicles without a smart entry & start system

Turn the engine switch to the “ON” position.

Vehicles with a smart entry & start system

Turn the “ENGINE START STOP” switch to IGNITION ON mode.

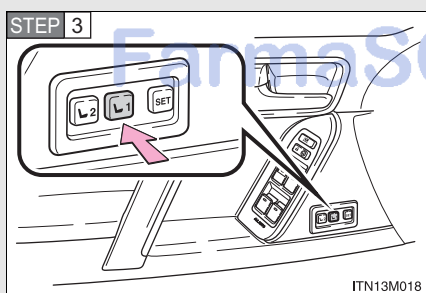

Press button 1 or 2 to recall the desired position.

**Linking driving position memory with door unlock operation
(vehicles with a smart entry & start system)**

Record your driving position to button 1 or 2 before performing the following:

Carry only the key to which you want to link the driving position. If 2 or more keys are in the vehicle, the driving position cannot be linked properly.

STEP 1 Turn the “ENGINE START STOP” switch IGNITION ON mode and close the driver’s door.

Vehicles with an automatic transmission

Check that the shift lever is in P.

Vehicles with a manual transmission

Check that the parking brake is set.

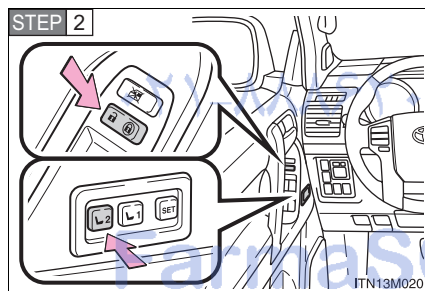

While pressing the desired button (1 or 2), press the driver’s door lock switches (either lock or unlock) until the signal beeps.

The driving position is recalled when the driver’s door is unlocked using the entry function or wireless remote control and the driver’s door is opened.

1

Before driving

■ **Operating the driving position memory after turning the engine off**

Vehicles without a smart entry & start system

Memorized positions (except the steering wheel position) can be activated up to 180 seconds after the driver's door is opened and another 60 seconds after it is closed again, even if the key is removed from the engine switch.

Vehicles with a smart entry & start system

Memorized positions (except the steering wheel position) can be activated up to 180 seconds after the driver's door is opened and another 60 seconds after it is closed again, even after turning the "ENGINE START STOP" switch off.

■ **Canceling the linked door unlock operation**

STEP 1 Turn the "ENGINE START STOP" switch IGNITION ON mode and close the driver's door.

STEP 2 While pressing "SET" button, press driver's door lock switches (either lock or unlock) until the signal beeps.

■ **Stopping seat position operation part-way through**

Perform any of the following operations:

- Press the "SET" button.
- Press button 1 or 2.
- Adjust the seat using the switches (only cancels seat position recall).

⚠ CAUTION

■ **Seat adjustment caution**

Take care during seat adjustment so that the seat does not strike the rear passenger or squeeze your body against the steering wheel.

1-3. Adjustable components (seats, mirrors, steering wheel) Head restraints

Front, second and third manual seats (if equipped)

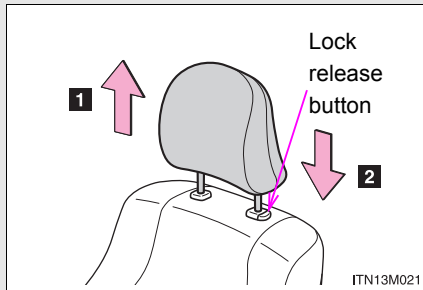

Vertical adjustment

1 Up

Pull the head restraints up.

2 Down

Push the head restraint down while pushing the lock release button.

Third power seats (if equipped)

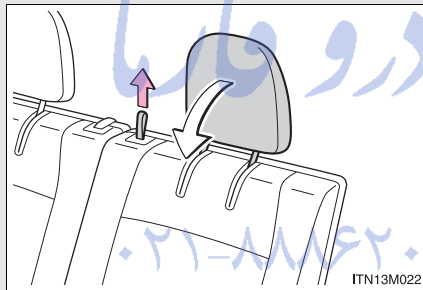

To fold

Pull the lock release strap to fold the head restraint.

To return the head restraints, lift them up until they lock.

1

Before driving

FarmaSOS.com

■ **Removing the head restraints (front, second and third manual seats)**

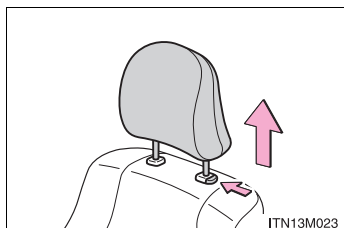

Pull the head restraint up while pressing the lock release button.

■ **Adjusting the height of the head restraints**

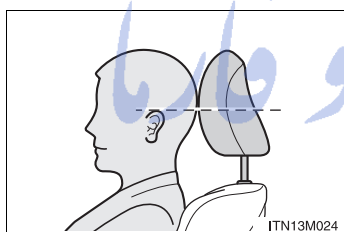

Make sure that the head restraints are adjusted so that the center of the head restraint is closest to the top of your ears.

■ **Using the second center, second outer (5-door models without third seats and vehicles with longitudinal type seats) and third manual seat head restraints.**

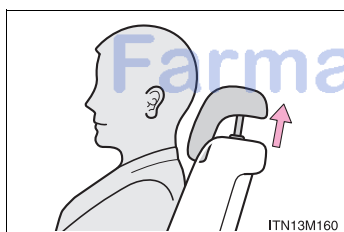

Always raise the head restraint one level from the stowed position when using.

1-3. Adjustable components (seats, mirrors, steering wheel)

■ Using the third power seats

Always lift the head restraints up until they lock when using.

■ Installing the head restraints

STEP 1 Align the head restraint with the installation holes.

STEP 2 Push down the head restraint to the lock position.

1

Before driving

⚠ CAUTION

■ Head restraint precautions

Observe the following precautions regarding the head restraints. Failure to do so may result in death or serious injury.

- Use the head restraints designed for each respective seat.
- Adjust the head restraints to the correct position at all times.
- After adjusting the head restraints, push down on them and make sure they are locked in position.
- Do not drive with the head restraints removed.

تلفن شبانه روزی: ۰۲۱-۸۸۶۲۰۸۵

FarmaSOS.com

1-3. Adjustable components (seats, mirrors, steering wheel) Seat belts

Make sure that all occupants are wearing their seat belts before driving the vehicle.

■ Correct use of the seat belts

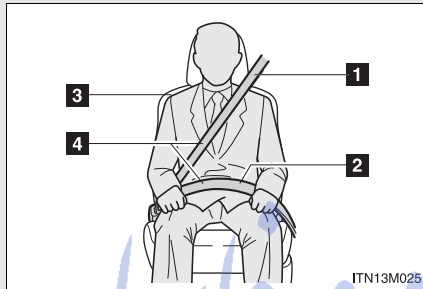

- 1 Extend the shoulder belt so that it comes fully over the shoulder, but does not come into contact with the neck or slide off the shoulder.
- 2 Position the lap belt as low as possible over the hips.
- 3 Adjust the position of the seatback. Sit up straight and well back in the seat.
- 4 Do not twist the seat belt.

تلفن شبانه روزی: ۰۲۱-۸۸۶۲۰۸۵

FarmaSOS.com

■ **Fastening and releasing the seat belt**

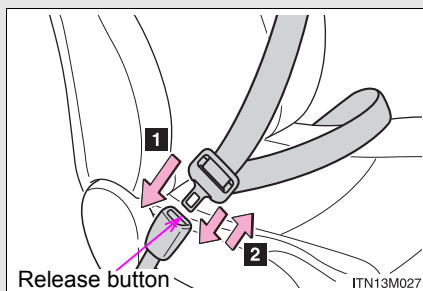

- 1** To fasten the seat belt, push the plate into the buckle until a click sound is heard.
- 2** To release the seat belt, press the release button.

■ **Adjusting the seat belt shoulder anchor height (front and outer second [5-door models] seats)**

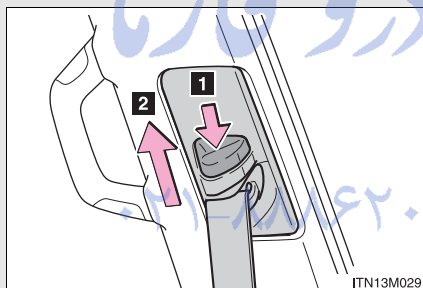

- 1** Push the seat belt shoulder anchor down while pressing the release button.
- 2** Push the seat belt shoulder anchor up.

Move the height adjuster up and down as needed until you hear a click.

1

Before driving

FarmaSOS.com

1-3. Adjustable components (seats, mirrors, steering wheel)

Seat belt pretensioners (front seats)

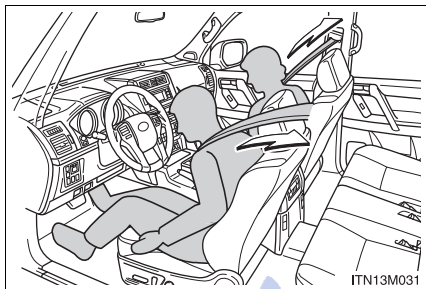

The pretensioner helps the seat belt to quickly restrain the occupant by retracting the seat belt when the vehicle is subjected to certain types of severe frontal collision or side collision (vehicles with SRS side airbags and curtain shield airbags).

The pretensioner may not activate in the event of a minor frontal or side impact, or a rear impact.

Pre-crash seat belts (front seats of vehicles with pre-crash safety system)

If the pre-crash sensor detects that a collision is unavoidable, the pre-crash safety system will retract the seat belt, thus enhancing the effectiveness of the seat belt pretensioner in a crash.

The same will happen if the driver makes an emergency braking or loses control of the vehicle. (→P. 380)

■ **Emergency locking retractor (ELR)**

The retractor will lock the belt during a sudden stop or on impact. It may also lock if you lean forward too quickly. A slow, easy motion will allow the belt to extend so that you can move around fully.

■ **Automatic locking retractor (ALR) (if equipped)**

When an outer second seat passenger's shoulder belt is completely extended and then retracted even slightly, the belt is locked in that position and cannot be extended. This feature is used to hold the child restraint system (CRS) firmly. To free the belt again, fully retract the belt and then pull the belt out once more. (→P. 197)

■ **Pregnant women**

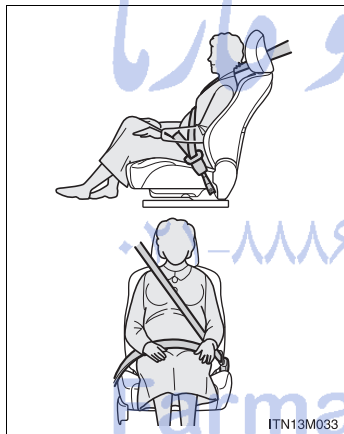

Obtain medical advice and wear the seat belt in the proper way. (→P. 122)

Women who are pregnant should position the lap belt as low as possible over the hips in the same manner as other occupants. Extend the shoulder belt completely over the shoulder and position the belt across the chest. Avoid belt contact over the rounding of the abdominal area.

If the seat belt is not worn properly, not only the pregnant woman, but also the fetus could suffer death or serious injury as a result of sudden braking, sudden swerving or a collision.

1-3. Adjustable components (seats, mirrors, steering wheel)

■ People suffering illness

Obtain medical advice and wear the seat belt in the proper way. (→P. 122)

■ Child seat belt usage

The seat belts of your vehicle were principally designed for persons of adult size.

- Use a child restraint system appropriate for the child, until the child becomes large enough to properly wear the vehicle's seat belt. (→P. 185)
- When the child becomes large enough to properly wear the vehicle's seat belt, follow the instructions on P. 122 regarding seat belt usage.

■ Replacing the belt after the pretensioner has been activated

If the vehicle is involved in multiple collisions, the pretensioner will activate for the first collision, but will not activate for the second or subsequent collisions.

■ Seat belt regulations

If seat belt regulations exist in the country where you reside, please contact any authorized Toyota dealer or repairer, or another duly qualified and equipped professional for seat belt replacement or installation.

تلفن شبانه روزی: ۰۲۱-۸۸۶۲۰۸۵

FarmaSOS.com

 CAUTION

Observe the following precautions to reduce the risk of injury in the event of sudden braking, sudden swerving or an accident.
Failure to do so may cause death or serious injury.

■ **Wearing a seat belt**

- Ensure that all passengers wear a seat belt.
- Always wear a seat belt properly.
- Each seat belt should be used by one person only. Do not use a seat belt for more than one person at once, including children.
- Toyota recommends that children be seated in the rear seat and always use a seat belt and/or an appropriate child restraint system.
- To achieve a proper seating position, do not recline the seat more than necessary. The seat belt is most effective when the occupants are sitting up straight and well back in the seats.
- Do not wear the shoulder belt under your arm.
- Always wear your seat belt low and snug across your hips.

■ **Adjustable shoulder anchor**

Always make sure the shoulder belt is positioned across the center of your shoulder. The belt should be kept away from your neck, but not falling off your shoulder. Failure to do so could reduce the amount of protection in an accident and cause death or serious injuries in the event of a sudden stop, sudden swerve or accident. (→P. 123)

■ **Seat belt pretensioners**

If the pretensioner has activated, the SRS warning light will come on. In that case, the seat belt cannot be used again and must be replaced at any authorized Toyota dealer or repairer, or another duly qualified and equipped professional.

 **CAUTION**

■ **When children are in the vehicle**

Do not allow children to play with the seat belt. If the seat belt becomes twisted around a child's neck, it may lead to choking or other serious injuries that could result in death.

If this occurs and the buckle cannot be unfastened, scissors should be used to cut the belt.

■ **Seat belt damage and wear**

- Do not damage the seat belts by allowing the belt, plate, or buckle to be jammed in the door.
- Inspect the seat belt system periodically. Check for cuts, fraying, and loose parts. Do not use a damaged seat belt until it is replaced. Damaged seat belt cannot protect an occupant from death or serious injury.
- Ensure that the belt and plate are locked and the belt is not twisted. If the seat belt does not function correctly, immediately contact any authorized Toyota dealer or repairer, or another duly qualified and equipped professional.
- Replace the seat assembly, including the belts, if your vehicle has been involved in a serious accident, even if there is no obvious damage.
- Do not attempt to install, remove, modify, disassemble or dispose of the seat belts. Have any necessary repairs carried out by any authorized Toyota dealer or repairer, or another duly qualified and equipped professional. Inappropriate handling of the pretensioner may prevent it from operating properly, resulting in death or serious injury.

1-3. Adjustable components (seats, mirrors, steering wheel) Steering wheel

The steering wheel can be adjusted to a comfortable position.

■ Manual adjustment

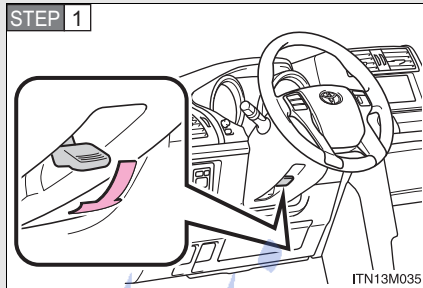

Hold the steering wheel and pull the lever down.

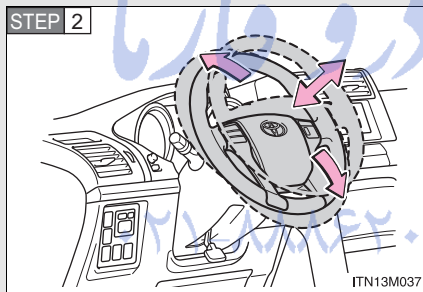

Adjust to the ideal position by moving the steering wheel horizontally and vertically.

After adjustment, pull the lever up to secure the steering wheel.

1

Before driving

FarmaSOS.com

■ Power adjustment

Operating the switch moves the steering wheel in the following directions:

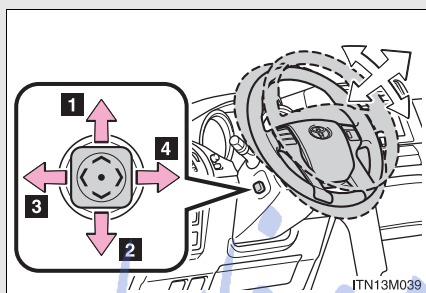

- 1 Up
- 2 Down
- 3 Away from the driver
- 4 Toward the driver

Auto tilt away (power adjustment type)

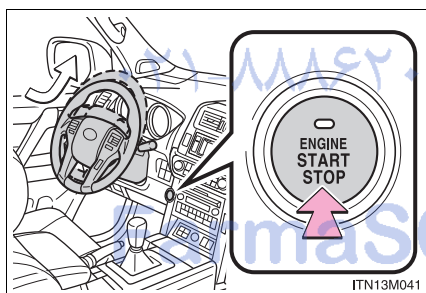

When the “ENGINE START STOP” switch is turned off, the steering wheel returns to its stowed position by moving up and away to enable easier driver entry and exit.

Turning the “ENGINE START STOP” switch to ACCESSORY or IGNITION ON mode will return the steering wheel to the original position.

■ **The power adjustment type steering wheel can be adjusted when**

The “ENGINE START STOP” switch is in ACCESSORY or IGNITION ON mode*.

*: If the driver’s seat belt is fastened, the steering wheel can be adjusted regardless of “ENGINE START STOP” switch mode.

■ **Automatic adjustment of the steering position**

A desired steering position can be entered to memory and recalled automatically by the driving position memory system. (→P. 115)

 **CAUTION**

■ **Caution while driving**

Do not adjust the steering wheel while driving. Doing so may cause the driver to mishandle the vehicle and cause an accident, resulting in death or serious injury.

■ **After adjusting the steering wheel (manual adjustment type)**

Make sure that the steering wheel is securely locked. Otherwise, the steering wheel may move suddenly, possibly causing an accident, and resulting in death or serious injury.

1

Before driving

FarmaSOS.com

1-3. Adjustable components (seats, mirrors, steering wheel) Inside rear view mirror

Glare from the headlights of vehicles behind can be reduced by using the following functions.

Manual anti-glare inside rear view mirror

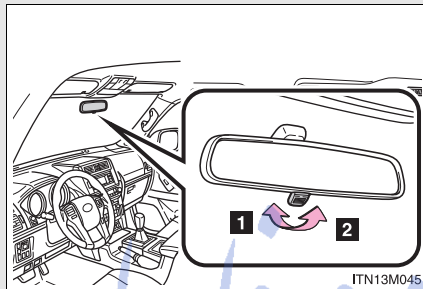

- 1 Normal position
- 2 Anti-glare position

Auto anti-glare inside rear view mirror

In automatic mode, sensors are used to detect the headlights of vehicles behind and the reflected light is automatically reduced.

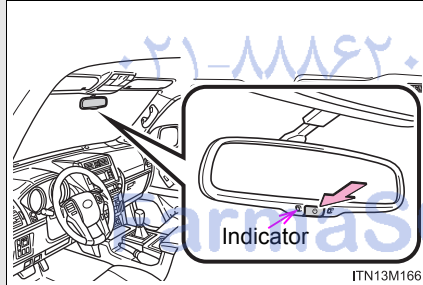

Turns automatic mode on/off

The indicator comes on when automatic mode is turned on.

The mirror will revert to the automatic mode each time the "ENGINE START STOP" switch is turned to IGNITION ON mode.

Adjusting the height of rear view mirror

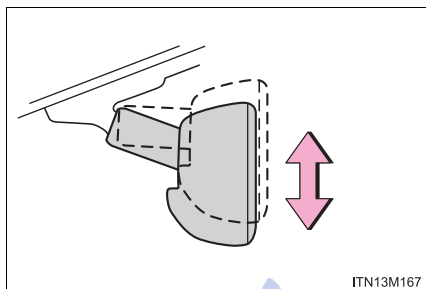

Adjust the height of the rear view mirror by moving it up and down.

1

Before driving

- To prevent sensor error (vehicles with auto anti-glare inside rear view mirror)

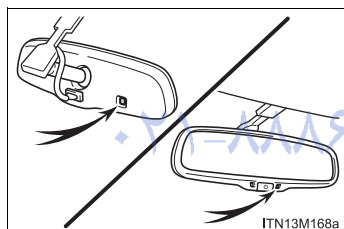

To ensure that the sensors operate properly, do not touch or cover them.

⚠ CAUTION

■ Caution while driving

Do not adjust the position of the mirror while driving. Doing so may lead to mishandling of the vehicle and an accident, resulting in death or serious injury.

1-3. Adjustable components (seats, mirrors, steering wheel) Outside rear view mirrors

Mirror angle can be be adjusted using the switch.

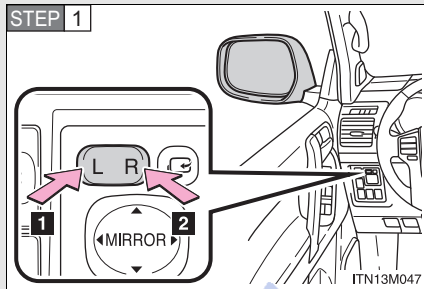

To select a mirror to adjust, press the switch.

- 1 Left
- 2 Right

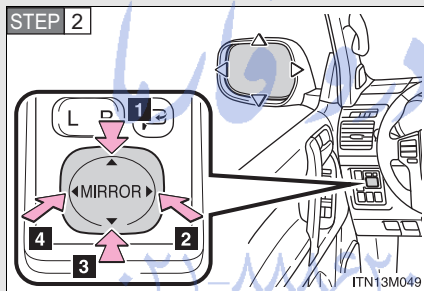

To adjust the mirror, press the switch.

- 1 Up
- 2 Right
- 3 Down
- 4 Left

FarmaSOS.com

Folding the mirrors

Manual type

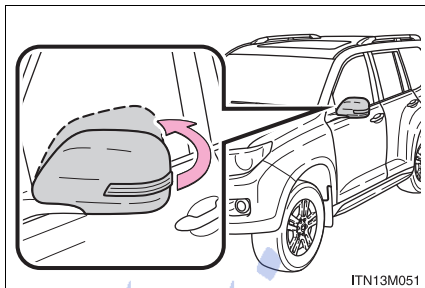

Push the mirror back in the direction of the vehicle's rear.

Auto type

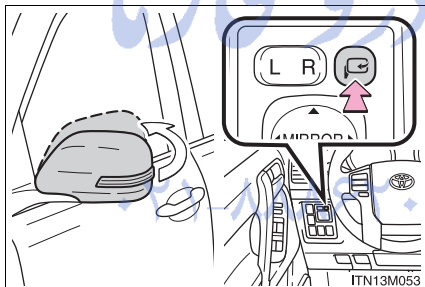

Press the switch to fold the mirrors.

Press it again to extend them to the original position.

1

Before driving

■ Mirror angle can be adjusted when

Vehicles without a smart entry & start system

The engine switch is in the "ACC" or "ON" position.

Vehicles with a smart entry & start system

The "ENGINE START STOP" switch is in ACCESSORY or IGNITION ON mode.

■ When the mirrors are fogged up (vehicles with mirror defoggers)

Turn on the mirror defoggers to defog the mirrors. (→P. 444)

1-3. Adjustable components (seats, mirrors, steering wheel)

CAUTION

■ When driving the vehicle

Observe the following precautions while driving.

Failing to do so may result in loss of control of the vehicle and cause an accident, resulting in death or serious injury.

- Do not adjust the mirrors while driving.
- Do not drive with the mirrors folded.
- Both the driver and passenger side mirrors must be extended and properly adjusted before driving.

■ When a mirror is moving

To avoid personal injury and mirror malfunction, be careful not to get your hand caught by the moving mirror.

■ When the mirror defoggers are operating (vehicles with mirror defoggers)

Do not touch the rear view mirror surfaces, as they can become very hot and burn you.

NOTICE

■ If ice should jam the mirror

Do not operate the control or scrape the mirror face. Use a spray de-icer to free the mirror.

1-4. Opening and closing the windows and moon roof Power windows

The power windows can be opened and closed using the switches.

Operating the switch moves the windows as follows:

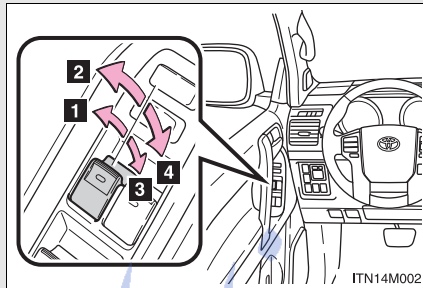

- 1 Closing
- 2 One-touch closing*
- 3 Opening
- 4 One-touch opening*

*: To stop the window partway, operate the switch in the opposite direction.

1

Before driving

Window lock switch

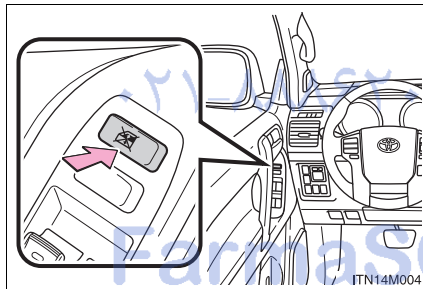

Press the switch down to lock the passenger window switches.

Use this switch to prevent children from accidentally opening or closing a passenger window.

■ **The power windows can be operated when**

Vehicles without a smart entry & start system

The engine switch is in the “ON” position.

Vehicles with a smart entry & start system

The “ENGINE START STOP” switch is in IGNITION ON mode.

■ **Operating the power windows after turning the engine off**

Vehicles without a smart entry & start system

The power windows can be operated for approximately 45 seconds even after the engine switch is turned to the “ACC” or “LOCK” position. They cannot, however, be operated once either front door is opened.

Vehicles with a smart entry & start system

The power windows can be operated for approximately 45 seconds even after the “ENGINE START STOP” switch is turned to ACCESSORY mode or turned off. They cannot, however, be operated once either front door is opened.

■ **Jam protection function**

If an object becomes caught between the window and the window frame, window travel is stopped and the window is opened slightly.

FarmaSOS.com

■ When the power window does not close normally

If the jam protection function is operating abnormally and a window cannot be closed, perform the following operations using the power window switch on the relevant door.

- After stopping the vehicle, the window can be closed by holding the power window switch in the one-touch closing position while the engine switch is in the “ON” position. (vehicles without a smart entry & start system), the “ENGINE START STOP” switch is turned to IGNITION ON mode (vehicles with a smart entry & start system).
- If the window still cannot be closed even by carrying out the operation explained above, initialize the function by performing the following procedure.

STEP 1 Hold the power window switch in the one-touch closing position. Continue holding the switch for a further 6 seconds after the window has closed.

STEP 2 Hold the power window switch in the one-touch opening position. Continue holding the switch for a further 2 seconds after the window has opened completely.

STEP 3 Hold the power window switch in the one-touch closing position once again. Continue holding the switch for a further 2 seconds after the window has closed.

If you release the switch while the window is moving, start again from the beginning. If the window continues to close but then re-open slightly even after performing the above procedure correctly, have the vehicle inspected by any authorized Toyota dealer or repairer, or another duly qualified and equipped professional.

1

Before driving

1-4. Opening and closing the windows and moon roof

■ Door lock linked window operation

The power windows can be opened and closed using the wireless remote control or key if customized at any authorized Toyota dealer or repairer, or another duly qualified and equipped professional. (→P. 66, 74)

■ Customization

Settings (e.g. linked door lock operation) can be changed.
(Customizable features →P. 849)



CAUTION

■ Closing the windows

Observe the following precautions.

Failing to do so may result in death or serious injury.

- Check to make sure that all passengers do not have any part of their body in a position where it could be caught when a window is being operated.
- Do not allow children to operate the power windows.
Closing a power window on someone can cause serious injury, and in some instances, even death.

■ Jam protection function

- Never use any part of your body to intentionally activate the jam protection function.
- The jam protection function may not work if something gets caught just before the window fully closes.

1-4. Opening and closing the windows and moon roof Moon roof*

Use the overhead switches to open and close the moon roof and tilt it up and down.

■ Opening and closing

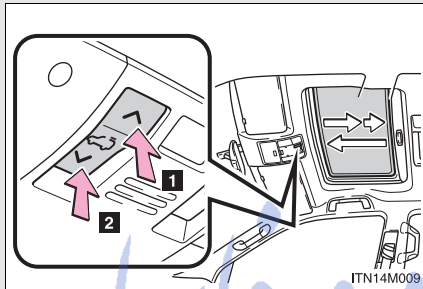

1 Opens the moon roof*

The moon roof stops slightly before the fully open position to reduce wind noise.

Press the switch again to fully open the moon roof.

2 Closes the moon roof*

*:Lightly press either of the moon roof switches to stop the moon roof partway.

■ Tilting up and down

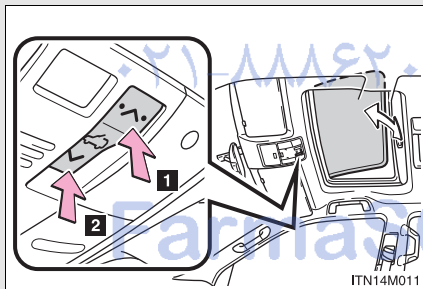

1 Tilts the moon roof up*

2 Tilts the moon roof down*

*:Lightly press either of the moon roof switches to stop the moon roof partway.

1

Before driving

*: If equipped

■ **The moon roof can be operated when**

Vehicles without a smart entry & start system

The engine switch is in the "ON" position.

Vehicles with a smart entry & start system

The "ENGINE START STOP" switch is in IGNITION ON mode.

■ **Operating the moon roof after turning the engine off**

Vehicles without a smart entry & start system

The moon roof can be operated for approximately 45 seconds after the engine switch is turned to the "ACC" or "LOCK" position. It cannot, however, be operated once either front door is opened.

Vehicles with a smart entry & start system

The moon roof can be operated for approximately 45 seconds after the "ENGINE START STOP" switch is turned to ACCESSORY mode or turned off. It cannot, however, be operated once either front door is opened.

■ **Jam protection function**

If an object is detected between the moon roof and the frame while the moon roof is closing or tilting down, travel is stopped and the moon roof opens slightly.

■ **Sunshade**

The sunshade can be opened and closed manually. However, the sunshade will open automatically when the moon roof is opened.

■ **Door lock linked moon roof operation**

The moon roof can be opened and closed using the wireless remote control or key if customized at any authorized Toyota dealer or repairer, or another duly qualified and equipped professional. (→P. 66, 74)

■ Moon roof open reminder function

Vehicles without a smart entry & start system

An alarm will sound when the driver's door is opened with the moon roof not fully closed and the engine switch off.

Vehicles with a smart entry & start system

An alarm will sound when the driver's door is opened with the moon roof not fully closed and the "ENGINE START STOP" switch off.

■ When the moon roof does not close normally

Perform the following procedure:

- If the moon roof closes but then re-opens slightly

STEP 1 Stop the vehicle.

STEP 2 Press and hold "∨" on the  *1

The moon roof will close, re-open and pause for approximately 10 seconds.*2 Then it will close again, tilt up and pause for approximately 1 second. Finally, it will tilt down, open and close.

STEP 3 Check to make sure that the moon roof is completely closed and then release the switch.

- If the moon roof tilts down but then tilts back up

STEP 1 Stop the vehicle.

STEP 2 Press and hold "∧" on the  *1 until the moon roof moves into the tilt up position and stops.

1

Before driving

1-4. Opening and closing the windows and moon roof

STEP 3 Release “^” on the  once and then press and hold “^” on the

 again.*1



The moon roof will pause for approximately 10 seconds in the tilt up position.*2 Then it will adjust slightly and pause for approximately 1 second.

Finally, it will tilt down, open and close.

STEP 4 Check to make sure that the moon roof is completely closed and then release the switch.

*1: If the switch is released at the incorrect time, the procedure will have to be performed again from the beginning.

*2: If the switch is released after the above mentioned 10 second pause, automatic operation will be disabled. In that case, press

and hold “v” on the  or “^” on the  and the moon roof will tilt up and pause for approximately 1 second. Then it will tilt down, open and close. Check to make sure that the moon roof is completely closed and then release the switch.

If the moon roof does not fully close even after performing the above procedure correctly, have the vehicle inspected by any authorized Toyota dealer or repairer, or another duly qualified and equipped professional.

■ Customization

Settings (e.g. linked door lock operation) can be changed.
(Customizable features →P. 849)

 CAUTION

■ **Opening the moon roof**

Observe the following precautions.

Failing to do so may cause death or serious injury.

- Do not allow any passengers to put their hands or heads outside the vehicle while it is moving.
- Do not sit on top of the moon roof.

■ **Closing the moon roof**

Observe the following precautions.

Failing to do so may result in death or serious injury.

- Check to make sure that all passengers do not have any part of their bodies in a position where it could be caught when the moon roof is being operated.
- Do not allow children to operate the moon roof.
Closing the moon roof on someone can cause death or serious injury.

■ **Jam protection function**

- Never use any part of your body to intentionally activate the jam protection function.
- The jam protection function may not work if something gets caught just before the moon roof fully closes.

1

Before driving

FarmaSOS.com

1-5. Refueling

Opening the fuel tank cap

Perform the following steps to open the fuel tank cap.

■ Before refueling the vehicle

Vehicles without a smart entry & start system

Turn the engine switch off and ensure that all the doors and windows are closed.

Vehicles with a smart entry & start system

Turn the "ENGINE START STOP" switch off and ensure that all the doors and windows are closed.

■ Opening the fuel tank cap

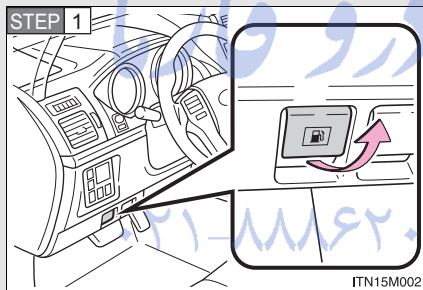

Pull up the opener to open the fuel filler door.

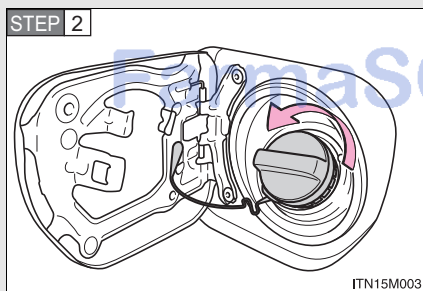

Turn the fuel tank cap slowly to open.

STEP 3

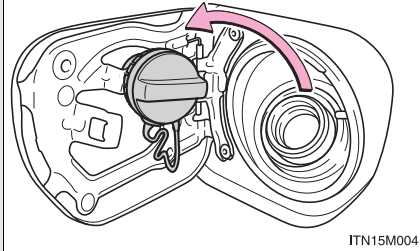

Hang the fuel tank cap on the back of the fuel filler door.

1

Before driving

Closing the fuel tank cap

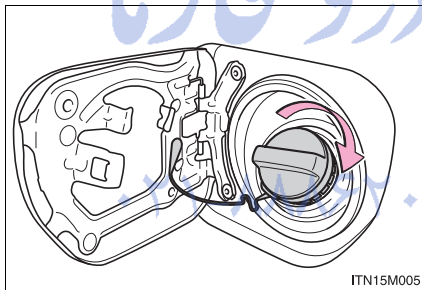

After refueling, turn the fuel tank cap until you hear a click. Once the cap is released, it will turn slightly in the opposite direction.

تلفن شبانه روزی: ۰۸۵

FarmaSOS.com

■ **Fuel types**

1GR-FE engine

EU area:

Your vehicle must use only unleaded gasoline conforming to European standard EN228.

For optimum engine performance, select unleaded gasoline with a Research Octane Number of 95 or higher.

If this premium type cannot be obtained, you can temporarily use unleaded gasoline with a Research Octane Number as low as 91.

Except EU area:

Your vehicle must use only unleaded gasoline.

For optimum engine performance, select unleaded gasoline with a Research Octane Number of 95 or higher.

If this premium type cannot be obtained, you can temporarily use unleaded gasoline with a Research Octane Number as low as 91.

2TR-FE engine

EU area:

Your vehicle must use only unleaded gasoline conforming to European standard EN228.

For optimum engine performance, select unleaded gasoline with a Research Octane Number of 91 or higher.

Except EU area:

Your vehicle must use only unleaded gasoline.

For optimum engine performance, select unleaded gasoline with a Research Octane Number of 91 or higher.

1KD-FTV engine

EU area:

Your vehicle must use only diesel fuel conforming to European standard EN590.

Except EU area:

Without DPF catalytic converter*¹

Your vehicle must use only diesel fuel that contains 350 ppm or less of sulfur and has a cetane number of 48 or higher.

With DPF catalytic converter*²

Your vehicle must use only diesel fuel that contains 50 ppm or less of sulfur and has a cetane number of 48 or higher.

*¹: Vehicles for Russia, Ukraine, Serbia, Montenegro, Macedonia and Croatia or KDJ150L-GKFEY and KDJ150L-GKAEY models*³

*²: KDJ150R-GKFEYW, KDJ150R-GKAEYW, KDJ150L-GKFEYW, KDJ150L-GKAEYW, KDJ155R-GJFEYW, KDJ155R-GJAEYW, KDJ155L-GJFEYW and KDJ155L-GJAEYW models*³ except for Russia, Ukraine, Serbia, Montenegro, Macedonia and Croatia

*³: The model code is indicated on the manufacturer's label. (→P. 815)

■ **Use of ethanol blended gasoline in a gasoline engine (1GR-FE engine)**

Toyota allows the use of ethanol blended gasoline where the ethanol content is up to 10 %. Make sure that the ethanol blended gasoline to be used has a Research octane number that follows the above.

■ **Fuel tank capacity**

Vehicles without sub fuel tank system

Approximately 87 L (23.0 gal., 19.1 Imp.gal.)

Vehicles with sub fuel tank system

Approximately 150 L (39.6 gal., 33.0 Imp.gal)

 CAUTION

■ **When refueling the vehicle**

Observe the following precautions while refueling the vehicle. Failure to do so may result in death or serious injury.

- After exiting the vehicle and before opening the fuel door, touch an unpainted metal surface to discharge any static electricity. It is important to discharge static electricity before refueling because sparks resulting from static electricity can cause fuel vapors to ignite while refueling.
- Always hold the grips on the fuel tank cap and turn it slowly to remove it. A whooshing sound may be heard when the fuel tank cap is loosened. Wait until the sound cannot be heard before fully removing the cap. In hot weather, pressurized fuel may spray out of the filler neck and cause injury.
- Do not allow anyone that has not discharged static electricity from their body to come close to an open fuel tank.
- Do not inhale vaporized fuel.
Fuel contains substances that are harmful if inhaled.
- Do not smoke while refueling the vehicle.
Doing so may cause the fuel to ignite and cause a fire.
- Do not return to the vehicle or touch any person or object that is statically charged.
This may cause static electricity to build up, resulting in a possible ignition hazard.

⚠ CAUTION**■ When refueling**

Securely insert the fuel nozzle into the fuel filler neck. If fuel is added with the nozzle slightly lifted away from the fuel filler neck, the automatic shut off function may not operate, resulting in fuel overflowing from the tank.

■ When replacing the fuel cap

Do not use anything but a genuine Toyota fuel tank cap designed for your vehicle. Doing so may cause a fire or other incident which may result in death or serious injury.

⚠ NOTICE**■ Refueling**

Do not spill fuel during refueling.

Doing so may damage the vehicle, such as causing the emission control systems to operate abnormally or damaging fuel system components or the vehicle's painted surface.

1

Before driving

امداد خودرو فارما
تلفن شبانه روزی: ۰۲۱-۸۸۶۲۰۸۵

FarmaSOS.com

1-6. Theft deterrent system Engine immobilizer system

The vehicle's keys have built-in transponder chips that prevent the engine from starting if a key has not been previously registered in the vehicle's on-board computer.

Never leave the keys inside the vehicle when you leave the vehicle.

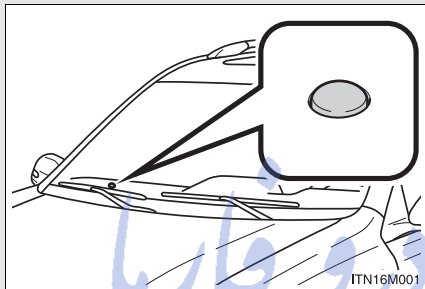

Vehicles without a smart entry & start system

The indicator light flashes after the key has been removed from the engine switch to indicate that the system is operating.

The indicator light stops flashing after the registered key has been inserted into the engine switch to indicate that the system has been canceled.

Vehicles with a smart entry & start system

The indicator light flashes after the "ENGINE START STOP" switch has been turned off to indicate that the system is operating.

The indicator light stops flashing after the "ENGINE START STOP" switch has been turned to ACCESSORY or IGNITION ON mode to indicate that the system has been canceled.

■ **System maintenance**

The vehicle has a maintenance-free type engine immobilizer system.

■ **Conditions that may cause the system to malfunction**

- If the key is in contact with a metallic object
- If the key is in close proximity to or touching a key to the security system (key with a built-in transponder chip) of another vehicle

1

Before driving

امداد خودرو فارما

تلفن شبانه روزی: ۰۲۱-۸۸۸۶۲۰۸۵

FarmaSOS.com

1-6. Theft deterrent system

■ Certification for the engine immobilizer system

Hereby, Tokai Rika Co., Ltd., declares that this RI-33BTY is in compliance with the essential requirements and other relevant provisions of Directive 1999/5/EC.

TOKAI RIKA

R&TTE Declaration of Conformity

We,

Manufacturer's Name: Tokai Rika Co., Ltd.

Manufacturer's Address: 260, Toyota 3-chome, Oguchi-cho, Niwa-gun, Aichi-ken,
480-0195, Japan

hereby declare under our sole responsibility that the product:

Product Name: Immobilizer

Product Model: RI-33BTY

to which this declaration relates is in conformity with the essential requirements and other relevant requirements of the R&TTE Directive (1999/5/EC). The product is compliant with the following standards and/or other normative documents:

Safety: EN60950-1

EMC: EN301 489-1 & -3

Spectrum: EN300 330-2

Supplementary information:

* CE mark	
* Member states intended for use	EU and EFTA
* Member states with restrictive use	None

Date:

6 February 2008

Signature:

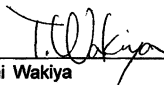

Position of the signatory:

Tadashi Wakiya
General Manager,
Electronics Engineering Div.

Hereby, Tokai Rika Co., Ltd., declares that this RI-33BTY is in compliance with the essential requirements and other relevant provisions of Directive 1999/5/EC.
Tokai Rika Co., Ltd. vakuuttaa täten että RI-33BTY tyyppinen laite on direktiivin 1999/5/EY oleellisten vaatimusten ja sitä koskevien direktiivin muiden ehtojen mukainen.
Hierbij verklaart Tokai Rika Co., Ltd. dat het toestel RI-33BTY in overeenstemming is met de essentiële eisen en de andere relevante bepalingen van richtlijn 1999/5/EG.
Par la présente Tokai Rika Co., Ltd. déclare que l'appareil RI-33BTY est conforme aux exigences essentielles et aux autres dispositions pertinentes de la directive 1999/5/CE.
Härmed intygar Tokai Rika Co., Ltd. att denna RI-33BTY står i överensstämmelse med de väsentliga egenskapskrav och övriga relevanta bestämmelser som framgår av direktiv 1999/5/EG.
Undertegnede Tokai Rika Co., Ltd. erklærer herved, at følgende udstyr RI-33BTY overholder de væsentlige krav og øvrige relevante krav i direktiv 1999/5/EF.
Hiermit erklärt Tokai Rika Co., Ltd., dass sich das Gerät RI-33BTY in Übereinstimmung mit den grundlegenden Anforderungen und den übrigen einschlägigen Bestimmungen der Richtlinie 1999/5/EG befindet.
ΜΕ ΤΗΝ ΠΑΡΟΥΣΑ Tokai Rika Co., Ltd. ΔΗΛΩΝΕΙ ΟΤΙ RI-33BTY ΣΥΜΜΟΡΦΩΝΕΤΑΙ ΠΡΟΣ ΤΙΣ ΟΥΣΙΩΔΕΙΣ ΑΠΑΙΤΗΣΕΙΣ ΚΑΙ ΤΙΣ ΛΟΙΠΕΣ ΣΧΕΤΙΚΕΣ ΔΙΑΤΑΞΕΙΣ ΤΗΣ ΟΔΗΓΙΑΣ 1999/5/ΕΚ.
Con la presente Tokai Rika Co., Ltd. dichiara che questo RI-33BTY è conforme ai requisiti essenziali ed alle altre disposizioni pertinenti stabilite dalla direttiva 1999/5/CE.
Por medio de la presente Tokai Rika Co., Ltd. declara que RI-33BTY cumple con los requisitos esenciales y cualesquiera otras disposiciones aplicables o exigibles de la Directiva 1999/5/CE.
Tokai Rika Co., Ltd. declara que este RI-33BTY está conforme com os requisitos essenciais e outras disposições da Directiva 1999/5/CE.
Hawnhekk, Tokai Rika Co., Ltd., jiddikjara li dan RI-33BTY jikkonforma mal-htigijiet essenzjali u ma provvedimenti oħrajn relevanti li hemm fid-Dirrettiva 1999/5/EC.

1

Before driving

1-6. Theft deterrent system

<p>Käesolevaga kinnitab Tokai Rika Co., Ltd. seadme RI-33BTY vastavust direktiivi 1999/5/EÜ põhinõuetele ja nimetatud direktiivist tulenevatele teistele asjakohastele sätetele.</p>
<p>Alulírott, Tokai Rika Co., Ltd. nyilatkozom, hogy a RI-33BTY megfelel a vonatkozó alapvető követelményeknek és az 1999/5/EC irányelv egyéb előírásainak.</p>
<p>Tokai Rika Co., Ltd. týmto vyhlasuje, že RI-33BTY spĺňa základné požiadavky a všetky príslušné ustanovenia Smernice 1999/5/ES.</p>
<p>Tokai Rika Co., Ltd. tímto prohlašuje, že tento RI-33BTY je ve shodě se základními požadavky a dalšími příslušnými ustanoveními směrnice 1999/5/ES.</p>
<p>Tokai Rika Co., Ltd. izjavlja, da je ta RI-33BTY v skladu z bistvenimi zahtevami in ostalimi relevantnimi določili direktive 1999/5/ES.</p>
<p>Šiuo Tokai Rika Co., Ltd. deklaruoja, kad šis RI-33BTY atitinka esminius reikalavimus ir kitas 1999/5/EB Direktyvos nuostatas.</p>
<p>Ar šo Tokai Rika Co., Ltd. deklarē, ka RI-33BTY atbilst Direktīvas 1999/5/EK būtiskajām prasībām un citiem ar to saistītajiem noteikumiem.</p>
<p>Niniejszym Tokai Rika Co., Ltd. oświadcza, że RI-33BTY jest zgodny z zasadniczymi wymogami oraz pozostałymi stosownymi postanowieniami Dyrektywy 1999/5/EC.</p>
<p>Hér með lýsir Tokai Rika Co., Ltd. yfir því að RI-33BTY er í samræmi við grunnkröfur og aðrar kröfur, sem gerðar eru í tilskipun 1999/5/EC.</p>
<p>Tokai Rika Co., Ltd. erklærer herved at utsyret RI-33BTY er i samsvar med de grunnleggende krav og øvrige relevante krav i direktiv 1999/5/EF.</p>
<p>Ovim, Tokai Rika Co., Ltd., izjavljuje da ovaj RI-33BTY je usklađen sa bitnim zahtjevima i drugim relevantnim odredbama Direktive 1999/5/EC.</p>

 NOTICE

■ **To ensure the system operates correctly**

Do not modify or remove the system. If modified or removed, the proper operation of the system cannot be guaranteed.

1

Before driving

امداد خودرو فارما

تلفن شبانه روزی: ۰۲۱-۸۸۸۶۲۰۸۵

FarmaSOS.com

1-6. Theft deterrent system Double locking system*

Unauthorized access to the vehicle is prevented by disabling the door unlocking function from both the interior and exterior of the vehicle.

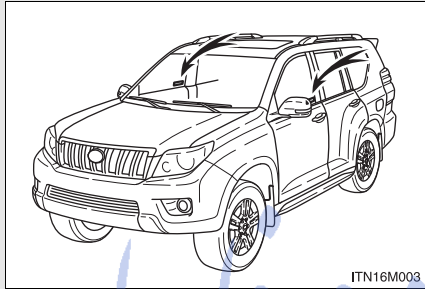

Vehicles employing this system have labels on the window glass of both front doors.

تلفن شبانه روزی: ۰۲۱-۸۸۸۶۲۰۸۵

FarmaSOS.com

*: If equipped

Setting the double locking system

Turn the “ENGINE START STOP” switch off, have all the passengers exit the vehicle and ensure that all the doors are closed.

Using the entry function:

Touch the sensor area on the front outside door handles twice within 5 seconds.

Using the wireless remote control:

Press  twice within 5 seconds.

Canceling the double locking system

Using the entry function:

Hold the outside door handle on the driver's side.

Using the wireless remote control: Press  .

⚠ CAUTION**■ Double locking system precaution**

Never activate the double locking system when there are people in the vehicle, because all the doors cannot be opened from inside the vehicle.

1

Before driving

1-6. Theft deterrent system Alarm*

The system sounds the alarm and flashes lights when forcible entry is detected.

■ Triggering of the alarm

The alarm is triggered in the following situations when the alarm is set:

- A locked door or glass hatch (if equipped) is unlocked or opened in any way other than using the entry function (vehicles with a smart entry & start system) or the wireless remote control. (The doors will lock again automatically.)
- The hood is opened.
- The intrusion sensor detects something moving inside the vehicle. (An intruder gets in the vehicle.) (if equipped)
- The tilt sensor detects a change of vehicle inclination. (vehicles for U.K.)
- The quarter windows (5-door models) or back door window are broken. (if equipped)

FarmaSOS.com

*: If equipped

■ **Setting the alarm system**

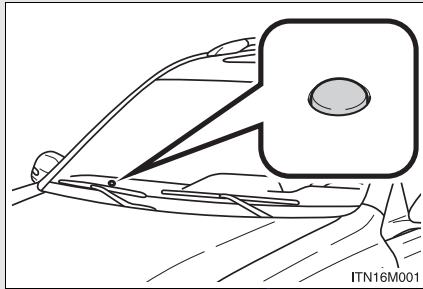

Close the doors, glass hatch and hood, and lock all the doors using the entry function or wireless remote control. The system will be set automatically after 30 seconds.

The indicator light changes from being on to flashing when the system is set.

■ **Deactivating or stopping the alarm**

Do one of the following to deactivate or stop the alarm.

- Unlock the doors using the entry function or the wireless remote control.
- Start the engine. (The alarm will be deactivated or stopped after a few seconds.)

1

Before driving

FarmaSOS.com

Intrusion sensor and tilt sensor (if equipped)

- The intrusion sensor detects an intruder or movement in the vehicle.
- The tilt sensor detects changes in vehicle inclination, such as when the vehicle is towed away.

This system is designed to deter and prevent vehicle theft but does not guarantee absolute security against all intrusions.

The intrusion sensor and tilt sensor can be canceled using the cancel switch.

Canceling the intrusion sensor and tilt sensor

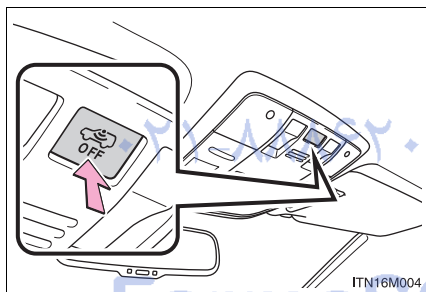

Turn the “ENGINE START STOP” switch off and press the intrusion sensor and tilt sensor cancel switch.

When the system is canceled, the indicator flashes rapidly.

■ System maintenance

The vehicle has a maintenance-free type alarm system.

■ **Items to check before locking the vehicle**

To prevent unexpected triggering of the alarm and vehicle theft, make sure of the following.

- Nobody is in the vehicle.
- The windows and moon roof are closed before the alarm is set.
- No valuables or other personal items are left in the vehicle.

■ **Triggering of the alarm**

The alarm may be triggered in the following situations:
(Stopping the alarm deactivates the alarm system.)

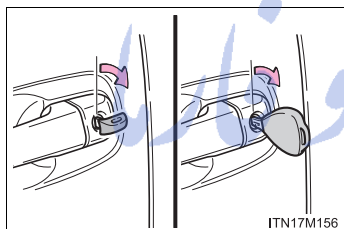

- The doors are unlocked using the key.



- A person inside the vehicle opens a door or hood.

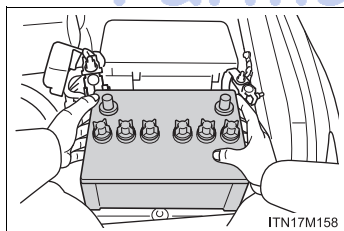

- The battery is disconnected.

1-6. Theft deterrent system

■ Alarm-operated door lock

- When the alarm is operating, the doors are locked automatically to prevent intruders.
- Do not leave the key inside the vehicle when the alarm is operating, and make sure the key is not inside the vehicle when recharging or replacing the battery.

■ Canceling and automatic re-enabling of the intrusion sensor and tilt sensor

- The alarm will still be set even when the intrusion sensor and tilt sensor are canceled.
- After the intrusion sensor and tilt sensor are canceled, pressing the “ENGINE START STOP” switch or unlocking the doors using the entry function or wireless remote control will re-enable the intrusion sensor and tilt sensor.
- When the alarm system is set again, the intrusion sensor and tilt sensor will be set.

تلفن شبانه روزی: ۰۲۱-۸۸۸۶۲۰۸۵

FarmaSOS.com

■ **Intrusion sensor considerations**

The sensor may trigger the alarm in the following situations:



- People or pets are in the vehicle.

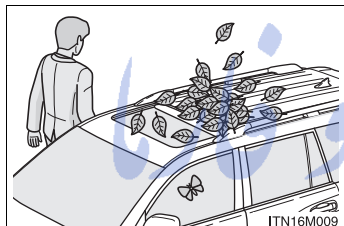

- A window or the moon roof is open. (The sensor may detect the movement of people outside the vehicle and the movement of objects such as leaves and insects entering the vehicle.)

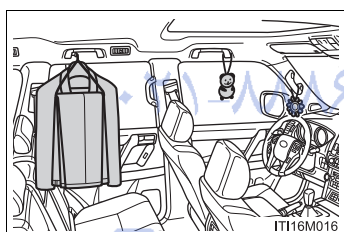

- Unstable items, such as dangling accessories or clothes hanging on the coat hooks, are in the vehicle.

1-6. Theft deterrent system

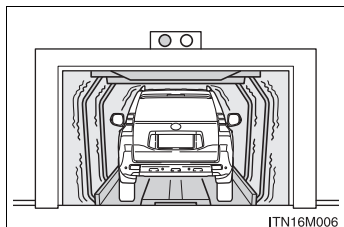

- The vehicle is parked in a place where extreme vibrations or noises occur, such as in a parking garage.

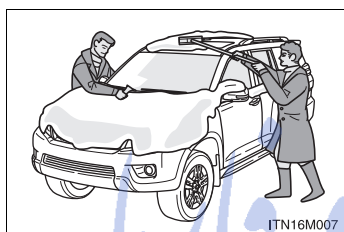

- Ice or snow is removed from the vehicle, causing the vehicle to receive repeated impacts or vibrations.

- The vehicle is inside an automatic or high-pressure car wash.
- The vehicle experiences impacts, such as hail, lightning strikes, and other kinds of repeated impacts or vibrations.

■ Tilt sensor detection considerations

The sensor may trigger the alarm in the following situations:

- The vehicle is transported by a ferry, trailer, train, etc.
- The vehicle is parked in a parking garage.
- The vehicle is inside a car wash that moves the vehicle.
- Any of the tires loses air pressure.
- The vehicle is jacked up.
- An earthquake occurs or the road caves in.
- Cargo is loaded onto or unloaded from the roof luggage carrier.

 NOTICE

■ To ensure the intrusion sensor and tilt sensor functions correctly

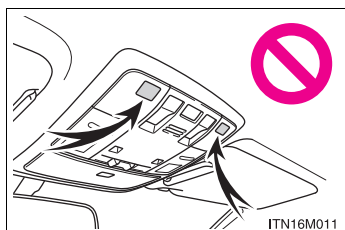

- To ensure that the sensors operate properly, do not touch or cover them.

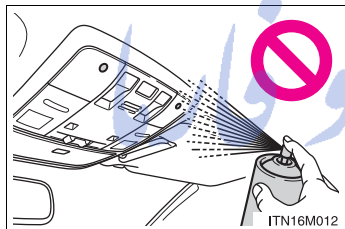

- Do not spray air fresheners or other products directly into the sensor holes.

■ To ensure the system operates correctly

Do not modify or remove the system. If modified or removed, the proper operation of the system cannot be guaranteed.

1-7. Safety information

Correct driving posture

Drive with a good posture as follows:

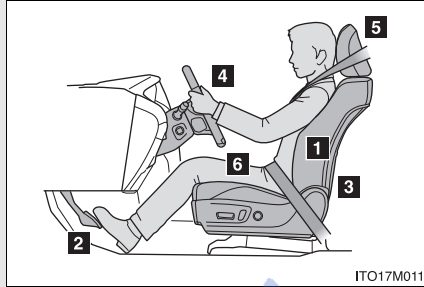

- 1** Sit upright and well back in the seat. (→P. 93)
- 2** Adjust the position of the seat forward or backward to ensure the pedals can be reached and easily depressed to the extent required. (→P. 93)
- 3** Adjust the seatback so that the controls are easily operable.
- 4** Adjust the tilt and telescopic positions of the steering wheel downward so the air-bag is facing your chest. (→P. 129)
- 5** Lock the head restraint in place with the center of the head restraint closest to the top of your ears. (→P. 119)
- 6** Wear the seat belt correctly. (→P. 122)

⚠ CAUTION**■ While driving**

- Do not adjust the position of the driver's seat.
Doing so could cause the driver to lose control of the vehicle.
- Do not place a cushion between the driver or passenger and the seatback.
A cushion may prevent correct posture from being achieved, and reduce the effectiveness of the seat belt and head restraint, increasing the risk of death or serious injury to the driver or passenger.
- Do not place anything under the front seats.
Objects placed under the front seats may become jammed in the seat tracks and stop the seat from locking in place. This may lead to an accident, resulting in death or serious injury. The adjustment mechanism may also be damaged.

■ Adjusting the seat position

- Take care when adjusting the seat position to ensure that other passengers are not injured by the moving seat.
- Do not put your hands under the seat or near the moving parts to avoid injury.
Fingers or hands may become jammed in the seat mechanism.

1

Before driving

FarmaSOS.com

1-7. Safety information

SRS airbags

The SRS airbags inflate when the vehicle is subjected to certain types of severe impacts that may cause significant injury to the occupants. They work together with the seat belts to help reduce the risk of death or serious injury.

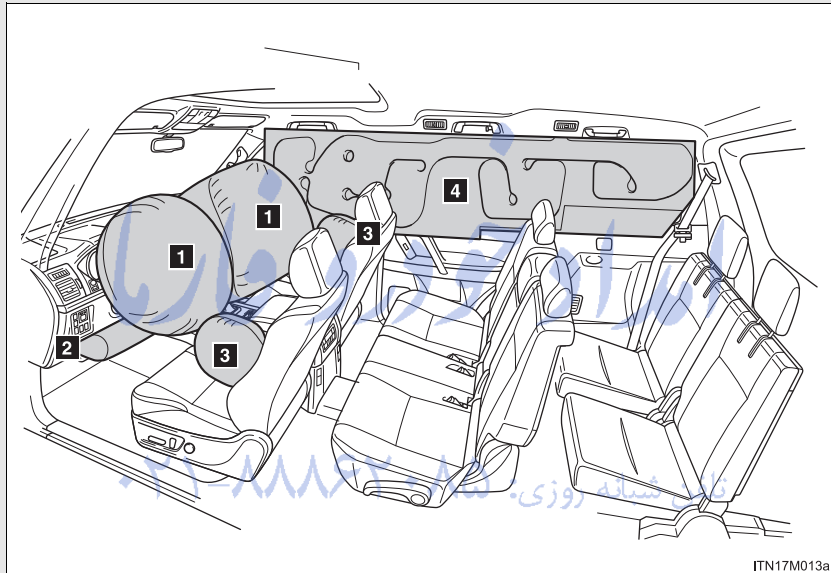

FarmaSOS.com

SRS front airbags

- 1** SRS driver airbag/front passenger airbag
Can help protect the head and chest of the driver and front passenger from impact with interior components
- 2** SRS driver knee airbag (if equipped)
Can help provide driver protection

SRS side and curtain shield airbags

- 3** SRS side airbags (if equipped)
Can help protect the torso of the front seat occupants
- 4** SRS curtain shield airbags (if equipped)
Can help protect primarily the head of occupants in the outer seats

1

Before driving

تلفن شبانه روزی: ۰۲۱-۸۸۸۶۲۰۸۵

FarmaSOS.com

Airbag system components

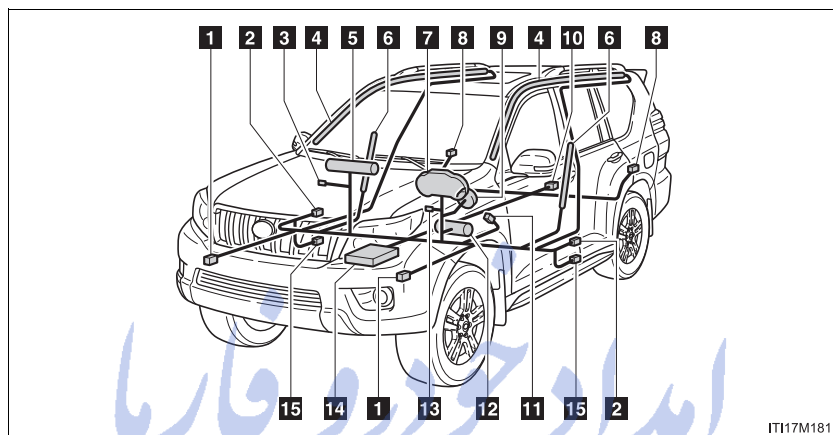

- | | |
|---|--|
| 1 Front airbag sensors | 8 Curtain shield airbag sensors (if equipped) |
| 2 Side and curtain shield airbag sensors (if equipped) | 9 Driver airbag |
| 3 Airbag manual on-off switch (if equipped) | 10 Floor sensor (if equipped) |
| 4 Curtain shield airbags (if equipped) | 11 Driver's seat belt buckle switch |
| 5 Front passenger airbag | 12 Driver knee airbag (if equipped) |
| 6 Side airbags (if equipped) | 13 Airbag manual off indicator (if equipped) |
| 7 SRS warning light | 14 Airbag sensor assembly |
| | 15 Seat belt pretensioners |

The main SRS airbag system components are shown above. The SRS airbag system is controlled by the airbag sensor assembly. As the airbags deploy, a chemical reaction in the inflators quickly fills the airbags with non-toxic gas to help restrain the motion of the occupants.

1

Before driving

■ **If the SRS airbags deploy (inflate)**

- Bruising and slight abrasions may result from contact with a deploying (inflating) SRS airbag.
- A loud noise and white powder will be emitted.

● **Vehicles with SRS curtain shield airbags**

Parts of the airbag module (steering wheel hub, airbag cover and inflator) as well as the front seats, parts of the front, center and rear pillars and roof side rail, may be hot for several minutes. The airbag itself may also be hot.

Vehicles without SRS curtain shield airbags

Parts of the airbag module (steering wheel hub, airbag cover and inflator) as well as the front seats may be hot for several minutes. The airbag itself may also be hot.

- The windshield may crack.

FarmaSOS.com

■ **SRS airbag deployment conditions (SRS front airbags)**

- The SRS front airbag will deploy in the event of an impact that exceeds the set threshold level (the level of force corresponding to an approximately 20 - 30 km/h [12 - 18 mph] frontal collision with a fixed wall that does not move or deform).

However, this threshold velocity will be considerably higher if the vehicle strikes an object, such as a parked vehicle or sign pole, which can move or deform on impact, or if the vehicle is involved in an underride collision (e.g. a collision in which the front of the vehicle “underrides”, or goes under, the bed of a truck, etc.).

- Depending on the type of collision, it is possible that only the seat belt pretensioners will activate.

■ **SRS airbag deployment conditions (SRS side airbags and curtain shield airbags)**

The SRS side and curtain shield airbags will deploy in the event of an impact that exceeds the set threshold level (the level of force corresponding to the impact force produced by an approximately 1500 kg [3307 lb.] vehicle colliding with the vehicle cabin from a direction perpendicular to the vehicle orientation at an approximate speed of 20 - 30 km/h [12 - 18 mph]).

تلفن شبانه روزی: ۰۲۱-۸۸۶۲۰۸۵

FarmaSOS.com

■ **Conditions under which the SRS airbags may deploy (inflate), other than a collision**

The SRS front airbags may also deploy if a serious impact occurs to the underside of your vehicle. Some examples are shown in the illustration.

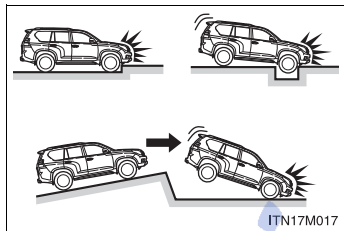

- Hitting a curb, edge of pavement or hard surface
- Falling into or jumping over a deep hole
- Landing hard or falling

■ **Types of collisions that may not deploy the SRS airbags (SRS front airbags)**

The SRS front airbags are generally not designed to inflate if the vehicle is involved in a side or rear collision, if it rolls over, or if it is involved in a low-speed frontal collision. But, whenever a collision of any type causes sufficient forward deceleration of the vehicle, deployment of the SRS front airbags may occur.

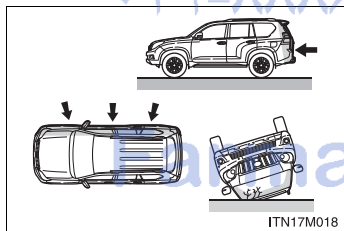

- Collision from the side
- Collision from the rear
- Vehicle rollover

■ **Types of collisions that may not deploy the SRS airbags
(SRS side airbags and curtain shield airbags)**

The SRS side airbag and curtain shield airbag system may not activate if the vehicle is subjected to a collision from the side at certain angles, or a collision to the side of the vehicle body other than the passenger compartment.

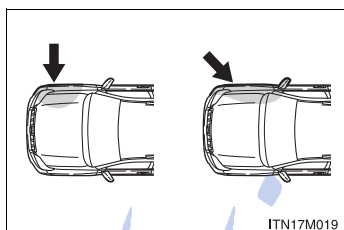

- Collision from the side to the vehicle body other than the passenger compartment
- Collision from the side at an angle

The SRS side airbags and curtain shield airbags are not generally designed to inflate if the vehicle is involved in a frontal or rear collision, if it rolls over, or if it is involved in a low-speed side collision.

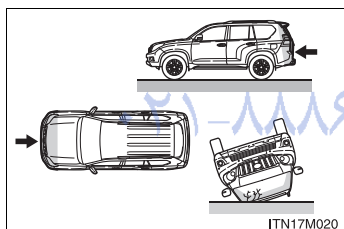

- Collision from the front
- Collision from the rear
- Vehicle rollover

FarmaSOS.com

■ **When to contact any authorized Toyota dealer or repairer, or another duly qualified and equipped professional**

In the following cases, contact any authorized Toyota dealer or repairer, or another duly qualified and equipped professional, as soon as possible.

- Any of the SRS airbags have been inflated.

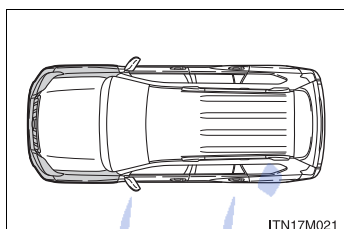

- The front of the vehicle is damaged or deformed, or was involved in an accident that was not severe enough to cause the SRS airbags to inflate.

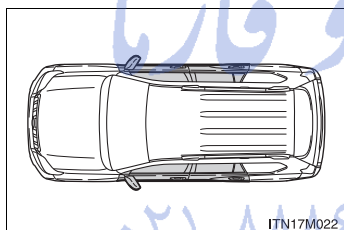

- A portion of a door is damaged or deformed, or the vehicle was involved in an accident that was not severe enough to cause the SRS side airbags and curtain shield airbags to inflate.

1

Before driving

FarmaSOS.com

1-7. Safety information

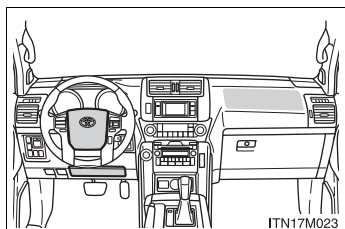

- **Vehicles without an SRS knee airbag**

The pad section of the steering wheel or dashboard near the front passenger airbag is scratched, cracked, or otherwise damaged.

- **Vehicles with an SRS knee airbag**

The pad section of the steering wheel, dashboard near the front passenger airbag cover or lower portion of the instrument panel is scratched, cracked, or otherwise damaged.

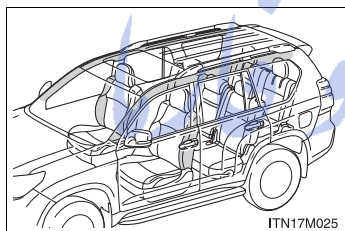

- The surface of the seats with the side airbag is scratched, cracked or otherwise damaged.

- The portion of the front pillars, center pillars, rear pillars or roof side rail garnishes (padding) containing the curtain shield airbags inside is scratched, cracked or otherwise damaged.

تلفن شبانه روزی: ۰۲۱-۸۸۶۲۰۸۵

FarmaSOS.com

⚠ CAUTION**■ SRS airbag precautions**

Observe the following precautions regarding the SRS airbags. Failure to do so may cause death or serious injury.

- The driver and all passengers in the vehicle must wear their seat belts properly.
The SRS airbags are supplemental devices to be used with the seat belts.
- The SRS driver airbag deploys with considerable force, and can cause death or serious injury especially if the driver is very close to the airbag.

Since the risk zone for the driver's airbag is the first 50 - 75 mm (2 - 3 in.) of inflation, placing yourself 250 mm (10 in.) from your driver airbag provides you with a clear margin of safety. This distance is measured from the center of the steering wheel to your breastbone. If you sit less than 250 mm (10 in.) away now, you can change your driving position in several ways:

- Move your seat to the rear as far as you can while still reaching the pedals comfortably.
- Slightly recline the back of the seat. Although vehicle designs vary, many drivers can achieve the 250 mm (10 in.) distance, even with the driver seat all the way forward, simply by reclining the back of the seat somewhat. If reclining the back of your seat makes it hard to see the road, raise yourself by using a firm, non-slippery cushion, or raise the seat if your vehicle has that feature.
- If your steering wheel is adjustable, tilt it downward. This points the airbag toward your chest instead of your head and neck.

The seat should be adjusted as recommended above, while still maintaining control of the foot pedals, steering wheel, and your view of the instrument panel controls.

1

Before driving

⚠ CAUTION

■ SRS airbag precautions

- The SRS front passenger airbag also deploys with considerable force, and can cause death or serious injury especially if the front passenger is very close to the airbag. The front passenger seat should be as far from the airbag as possible with the seatback adjusted, so the front passenger sits upright.
- Improperly seated and/or restrained infants and children can be killed or seriously injured by a deploying airbag. An infant or child who is too small to use a seat belt should be properly secured using a child restraint system. Toyota strongly recommends that all infants and children be placed in the rear seats of the vehicle and properly restrained. The rear seats are safer for infants and children than the front passenger seat. (→P. 185)

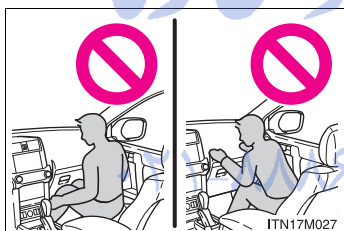

- Do not sit on the edge of the seat or lean against the dashboard.

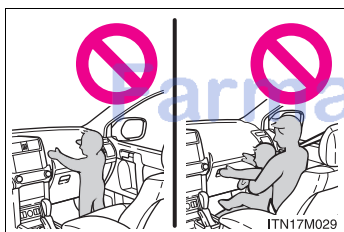

- Do not allow a child to stand in front of the SRS front passenger airbag unit or sit on the knees of a front passenger.
- Do not allow the front seat occupants to hold items on their knees.

CAUTION

SRS airbag precautions

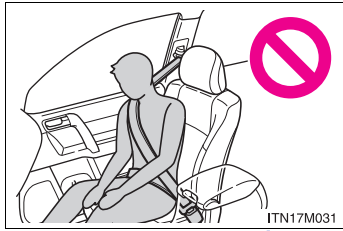

Vehicles without SRS curtain shield airbags

Do not lean against the front door.

Vehicles with SRS curtain shield airbags

Do not lean against the door, the roof side rail or the front, center and rear pillars.

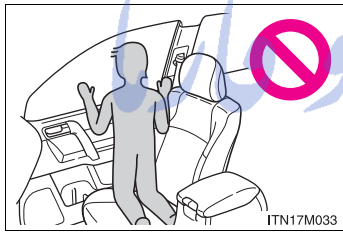

Do not allow anyone to kneel on the passenger seats toward the door or put their head or hands outside the vehicle.

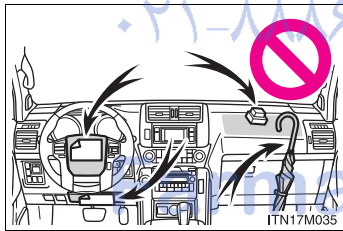

Do not attach anything to or lean anything against areas such as the dashboard, steering wheel pad and lower portion of the instrument panel.

These items can become projectiles when the SRS driver, front passenger and knee airbags deploy.

⚠ CAUTION

■ **SRS airbag precautions**

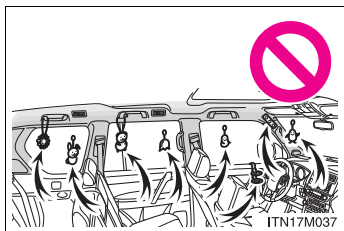

- Do not attach anything to areas such as the door, windshield glass, side door glass, front, center or rear pillars, roof side rail and assist grip. (Except for the speed limit label →P. 781)

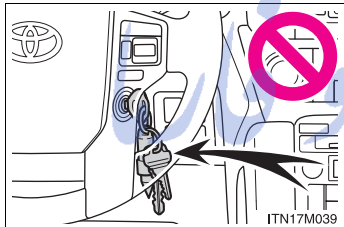

● **Vehicles without a smart entry & start system**

Do not attach any heavy, sharp or hard objects such as keys or accessories to the key. The objects may restrict the SRS knee airbag inflation or be thrust into the driver's seat area by the force of the deploying airbag, thus causing a danger.

- Do not hang coat hangers or other hard objects on the coat hooks. All of these items could become projectiles and may cause death or serious injury, should the SRS curtain shield airbag deploy.
- If the vinyl cover is put on the area where the SRS knee airbag will deploy, be sure to remove it.

⚠ CAUTION**■ SRS airbag precautions**

- Do not use seat accessories which cover the parts where the SRS side airbags inflate as they may interfere with inflation of the airbags. Such accessories may prevent the side airbags from activating correctly, disable the system or cause the side airbags to inflate accidentally, resulting in death or serious injury.
- Do not strike or apply significant levels of force to the area of the SRS airbag components.
Doing so can cause the SRS airbags to malfunction.
- Do not touch any of the component parts immediately after the SRS airbags have deployed (inflated) as they may be hot.
- If breathing becomes difficult after the SRS airbags have deployed, open a door or window to allow fresh air in, or leave the vehicle if it is safe to do so. Wash off any residue as soon as possible to prevent skin irritation.
- If the areas where the SRS airbags are stored, such as the steering wheel pad and front, center and rear pillar garnishes, are damaged or cracked, have them replaced by any authorized Toyota dealer or repairer, or another duly qualified and equipped professional. تلفن شبانه

1

Before driving

FarmaSOS.com

 CAUTION

■ **Modification and disposal of SRS airbag system components**

Do not dispose of your vehicle or perform any of the following modifications without consulting any authorized Toyota dealer or repairer, or another duly qualified and equipped professional. The SRS airbags may malfunction or deploy (inflate) accidentally, causing death or serious injury.

- Installation, removal, disassembly and repair of the SRS airbags
- Repairs, modifications, removal or replacement of the steering wheel, instrument panel, dashboard, seats or seat upholstery, front, center and rear pillars or roof side rail
- Repairs or modifications of the front fender, front bumper, or side of the occupant compartment
- Installation of snow plows, winches, etc. to the front grille (bull bars, kangaroo bar etc.)
- Modifications to the vehicle's suspension system
- Installation of electronic devices such as an RF-transmitter and CD players
- Modifications to your vehicle for a person with a physical disability

FarmaSOS.com

1-7. Safety information

Child restraint systems

Toyota strongly urges the use of child restraint systems.

Points to remember

Studies have shown that installing a child restraint on a rear seat is much safer than installing one to the front passenger seat.

- Choose a child restraint system that suits your vehicle and is appropriate to the age and size of the child.
- For installation details, follow the instructions provided with the child restraint system.
General installation instructions are provided in this manual.
(→P. 197)
- If child restraint system regulations exist in the country where you reside, please contact any authorized Toyota dealer or repairer, or another duly qualified and equipped professional for the child restraint system installation.
- Toyota recommends that you use a child restraint system which conforms to the regulation ECE No.44.

1

Before driving

FarmaSOS.com

Types of child restraints

Child restraint systems are classified into the following 5 groups according to the regulation ECE No.44.

Group 0: Up to 10 kg (22 lb.) (0 - 9 months)

Group 0⁺: Up to 13 kg (28 lb.) (0 - 2 years)

Group I: 9 to 18 kg (20 to 39 lb.) (9 months - 4 years)

Group II: 15 to 25 kg (34 to 55 lb.) (4 years - 7 years)

Group III: 22 to 36 kg (49 to 79 lb.) (6 years - 12 years)

In this owner's manual, the following 3 types of popular child restraint systems that can be secured with the seat belts are explained:

تلفن شبانه روزی: ۰۲۱-۸۸۸۶۲۰۸۵

FarmaSOS.com

Baby seat

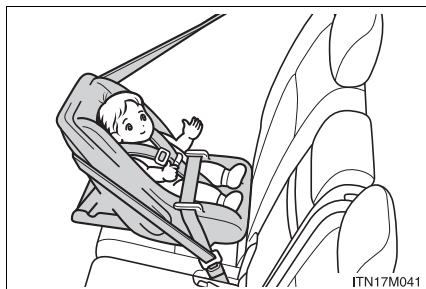

Equal to Group 0 and 0⁺ of ECE No.44

Child seat

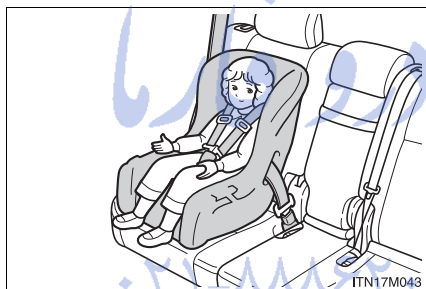

Equal to Group 0⁺ and I of ECE No.44

Junior seat

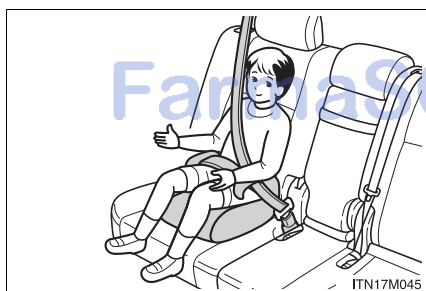

Equal to Group II and III of ECE No.44

1

Before driving

Child restraint system suitability for various seating positions

Information provided in the table shows your child restraint system suitability for various seating positions.

3-door models

Seating position Mass groups	Front passenger seat			Second seat	
	Standard	Airbag manual on-off switch		Outside	Center
		ON	OFF		
0 Up to 10 kg (22 lb.) (0 - 9 months)	X Never put	X Never put	U	U	U
0+ Up to 13 kg (28 lb.) (0 - 2 years)	X Never put	X Never put	U	U	U
I 9 to 18 kg (20 to 39 lb.) (9 months - 4 years)	Rear- facing — X Never put	Rear- facing — X Never put	U	U	U
	Forward- facing — UF*	Forward- facing — UF*			
II, III 15 to 36 kg (34 to 79 lb.) (4 - 12 years)	UF*	UF*	U	U	U

Key of letters inserted in the above table:

U: Suitable for “universal” category child restraint system approved for the use in this mass group.

UF: Suitable for forward-facing “universal” category child restraint system approved for the use in this mass group.

X: Not suitable seat position for children in this mass group.

NOTE:

*: Move the seatback to the most upright position.

The child restraint system mentioned in the table may not be available outside of the EU area.

Other child restraint system which is different from the system mentioned in the table can be used, but the suitability of the systems must be carefully checked with the child restraint system manufacturer concerned and the seller of those seats.

1

Before driving

تلفن شبانه روزی: ۰۲۱-۸۸۶۲۰۸۵

FarmaSOS.com

5-door models

Seating position Mass groups	Front passenger seat			Second seat		Third seat (if equipped)
	Standard	Airbag manual on-off switch		Outside	Center	
		ON	OFF			
0 Up to 10 kg (22 lb.) (0 - 9 months)	X Never put	X Never put	U	U	L1	L1
0+ Up to 13 kg (28 lb.) (0 - 2 years)	X Never put	X Never put	U	U	L1	L1
I 9 to 18 kg (20 to 39 lb.) (9 months - 4 years)	Rear-facing — X Never put	Rear-facing — X Never put	U	U	L2*2	L2*3
	Forward-facing — UF*1	Forward-facing — UF*1				
II, III 15 to 36 kg (34 to 79 lb.) (4 - 12 years)	UF*1	UF*1	U	U	L3*2	L3*4

Key of letters inserted in the above table:

- U: Suitable for “universal” category child restraint system approved for the use in this mass group.
- UF: Suitable for forward-facing “universal” category child restraint system approved for the use in this mass group.
- L1: Suitable for “TOYOTA G0⁺, BABYSAFE PLUS (0 to 13 kg [0 to 28 lb.])” approved for the use in this mass group
- L2: Suitable for “TOYOTA DUO+ (without ISOFIX, 9 to 18 kg [20 to 39 lb.])” approved for the use in this mass group
- L3: Suitable for “TOYOTA KID (15 to 36 kg [34 to 79 lb.])” approved for the use in this mass group
- X: Not suitable seat position for children in this mass group.

NOTE:

- *1: When you use a child restraint system in this position, move the seatback to the most upright position.
- *2: When you use a child restraint system in this position, move the head restraint to the lowest position. *تلفن شبانه روزی:*
- *3: When you use a child restraint system in this position, move the head restraint to the upmost position. (vehicles with third manual seats)
- *4: When you use a child restraint system in this position, remove the head restraint. (vehicles with third manual seats)

The child restraint system mentioned in the table may not be available outside of the EU area.

Other child restraint system which is different from the system mentioned in the table can be used, but the suitability of the systems must be carefully checked with the child restraint system manufacturer concerned and the seller of those seats.

**Child restraint system suitability for various seating positions
(with ISOFIX rigid anchors)**

Information provided in the table shows your child restraint system suitability for various seating positions.

Mass groups	Size class	Fixture	Vehicle ISOFIX positions
			Second seat
			Outside
Carrycot	F	ISO/L1	X
	G	ISO/L2	X
	(1)		X
0 Up to 10 kg (22 lb.) (0 - 9 months)	E	ISO/R1	X
		(1)	X
0+ Up to 13 kg (28 lb.) (0 - 2 years)	E	ISO/R1	X
	D	ISO/R2	X
	C	ISO/R3	X
		(1)	X
I 9 to 18 kg (20 to 39 lb.) (9 months - 4 years)	D	ISO/R2	X
	C	ISO/R3	X
	B	ISO/F2	IUF
	B1	ISO/F2X	IUF
	A	ISO/F3	IUF
		(1)	X
II, III 15 to 36 kg (34 to 79 lb.) (4 - 12 years)		(1)	X

- (1) For the child restraint system which do not carry the ISO/XX size class identification (A to G), for the applicable mass group, the car manufacturer shall indicate the vehicle specific ISOFIX child restraint system(s) recommended for each position

Key of letters inserted in the above table:

IUF: Suitable for ISOFIX forward-facing child restraint systems of universal category approved for use in this mass group

X: ISOFIX position not suitable for ISOFIX child restraint systems in this mass group and/or this size class.

The child restraint system mentioned in the table may not be available outside of the EU area.

Other child restraint systems different from the systems mentioned in the table can be used, but the suitability of the systems must be carefully checked with the child restraint system manufacturer and retailer.

1

Before driving

تلفن شبانه روزی: ۰۲۱-۸۸۶۲۰۸۵

FarmaSOS.com

■ **When installing a child restraint system on the front passenger seat or second seat (5-door models with third manual/power seats)**

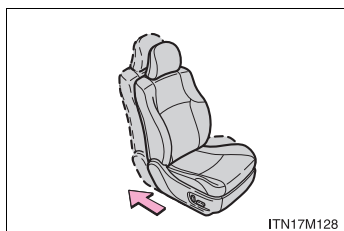

When you have to use a child restraint system, adjust the seat cushion to the fully rearward.

■ **Selecting an appropriate child restraint system**

- Use a child restraint system appropriate for the child until the child becomes large enough to properly wear the vehicle's seat belt.
- If the child is too large for a child restraint system, sit the child on a rear seat and use the vehicle's seat belt. (→P. 122)

تلفن شبانه روزی: ۰۲۱-۸۸۶۲۰۸۵

FarmaSOS.com

⚠ CAUTION**■ Using a child restraint system**

The use of a child restraint system not suitable for the vehicle may not properly secure the infant or child. It may result in death or serious injury (in the event of sudden braking, sudden swerving or an accident).

■ Child restraint precautions

- For effective protection in automobile accidents and sudden stops, a child must be properly restrained, using a seat belt or child restraint system depending on the age and size of the child. Holding a child in your arms is not a substitute for a child restraint system. In an accident, the child can be crushed against the windshield, or between you and the vehicle's interior.
- Toyota strongly urges the use of a proper child restraint system that conforms to the size of the child, installed on the rear seat. According to accident statistics, the child is safer when properly restrained in the rear seat than in the front seat.
- Never install a rear-facing child restraint system on the front passenger seat when the airbag manual on-off switch is on. (→P. 213)
In the event of an accident, the force of the rapid inflation of the front passenger airbag can cause death or serious injury to the child.
- A forward-facing child restraint system may be installed on the front passenger seat only when it is unavoidable. Always move the seat as far back as possible, because the front passenger airbag could inflate with considerable speed and force. Otherwise, the child may be killed or seriously injured.

1

Before driving

 CAUTION

■ **Child restraint precautions**

- Do not allow the child to lean his/her head or any part of his/her body against the door or the area of the seat, front, center and rear pillars or roof side rail from which the SRS side airbags or SRS curtain shield airbags deploy even if the child is seated in the child restraint system. It is dangerous if the SRS side airbags and curtain shield airbags inflate, and the impact could cause death or serious injury to the child.
- Make sure you have complied with all installation instructions provided by the child restraint manufacturer and that the system is properly secured. If it is not secured properly, it may cause death or serious injury to the child in the event of a sudden stop, sudden swerve or an accident.

■ **Child restraint lock function belt precaution**

Do not allow children to play with the child restraint lock function belt. If the belt becomes twisted around a child's neck, it will not be possible to pull the belt out leading to choking or other serious injuries that could result in death. If this occurs and the buckle cannot be unfastened, scissors should be used to cut the belt.

■ **When the child restraint system is not in use**

- Keep the child restraint system properly secured on the seat even if it is not in use. Do not store the child restraint system unsecured in the passenger compartment.
- If it is necessary to detach the child restraint system, remove it from the vehicle or store it securely in the luggage compartment. This will prevent it from injuring passengers in the event of a sudden stop, sudden swerve or an accident.

1-7. Safety information

Installing child restraints

Follow the child restraint system manufacturer's instructions. Firmly secure child restraints to the seats using a seat belt or ISOFIX rigid anchors. Attach the top strap when installing a child restraint.

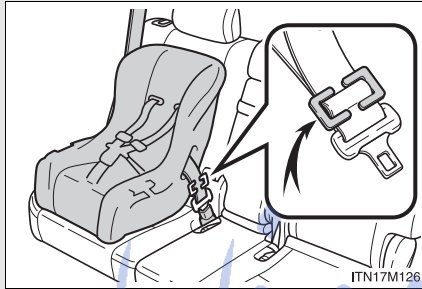

Seat belts (An ELR belt requires a locking clip)

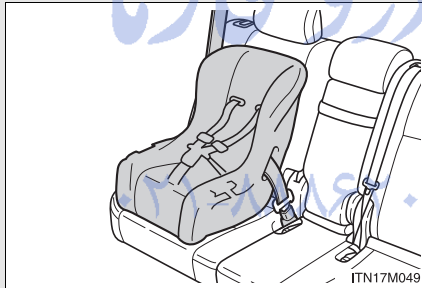

Vehicles for Ukraine, Kazakhstan, Azerbaijan and Georgia: Seat belts equipped with a child restraint locking mechanism (ALR/ELR belts on the outer second seats)

1

Before driving

FarmaSOS.com

1-7. Safety information

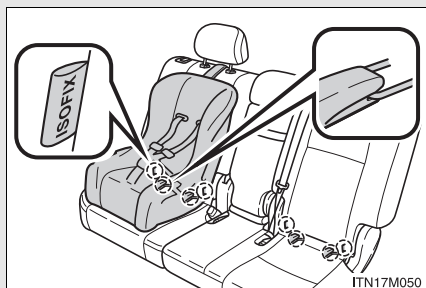

ISOFIX rigid anchors (ISOFIX child restraint system)

Lower anchors are provided for the outer second seats. (Tags displaying the location of the anchors are attached to the seats.)

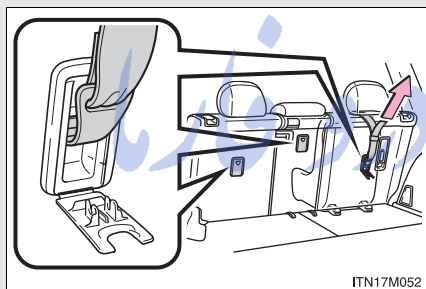

Anchor brackets (for the top strap)

An anchor bracket is provided for each second seat.

تلفن شبانه روزی: ۰۲۱-۸۸۶۲۰۸۵

FarmaSOS.com

Installing child restraints using a seat belt (child restraint lock function belt)

■ **Rear-facing — Baby seat/child seat**

3-door models

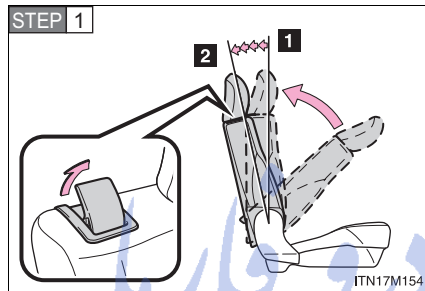

- 1** 1st lock position
- 2** 5th lock position

Fold the seatback forward and then back to the 1st lock position (most upright position) until it locks into place. Adjust the seatback to the 5th lock position.

5-door models

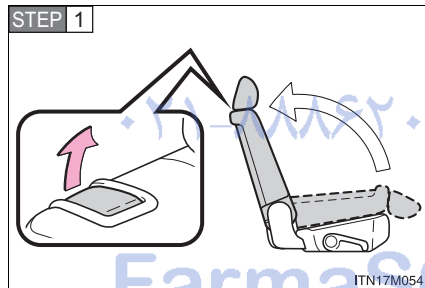

Fold the seatback forward. Then return the seatback and secure it at the first lock position (most upright position). (→P. 97)

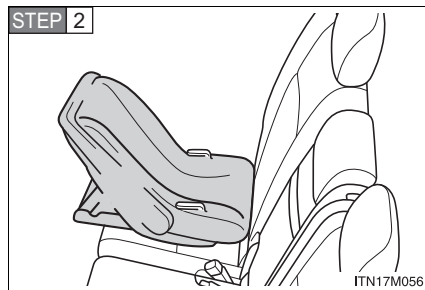

Place the child restraint system on the second seat facing the rear of the vehicle.

1

Before driving

1-7. Safety information

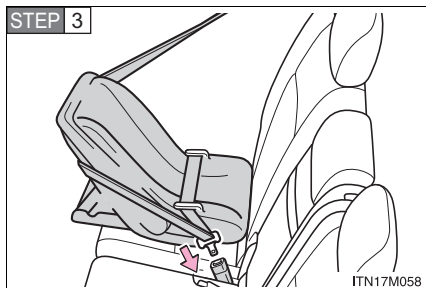

Run the seat belt through the child restraint system and insert the plate into the buckle. Make sure that the belt is not twisted.

■ Forward-facing — Child seat

3-door models

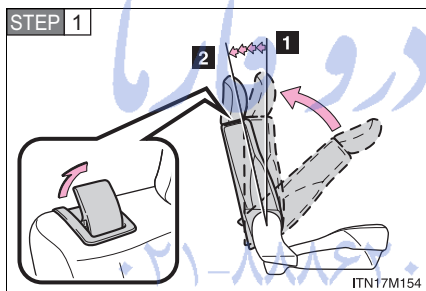

1 1st lock position

2 5th lock position

Fold the seatback forward and then back to the 1st lock position (most upright position) until it locks into place. Adjust the seatback to the 5th lock position.

5-door models

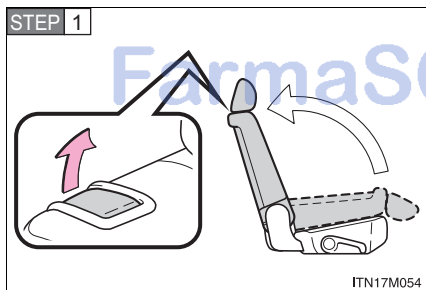

Fold the seatback forward. Then return the seatback and secure it at the first lock position (most upright position). (→P. 97)

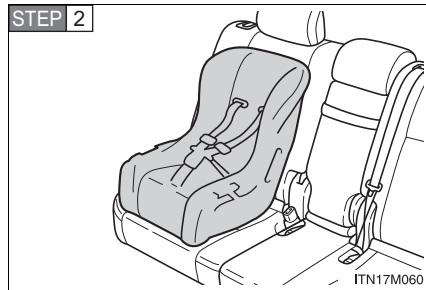

Place the child restraint system on the seat facing the front of the vehicle.

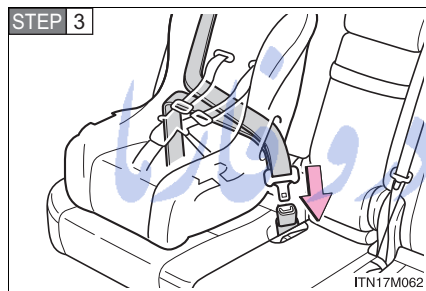

Run the seat belt through the child restraint system and insert the plate into the buckle. Make sure that the belt is not twisted.

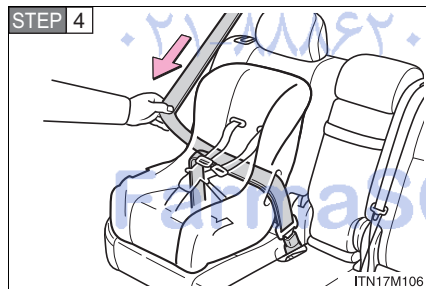

Fully extend the shoulder belt and allow it to retract to put it in lock mode. In lock mode, the belt cannot be extended.

1

Before driving

1-7. Safety information

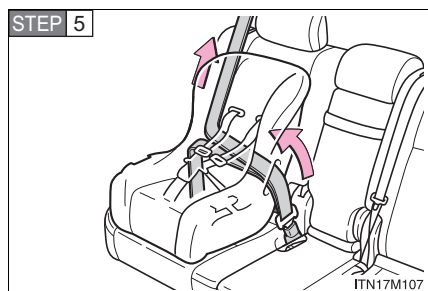

While pushing the child restraint system into the second seat, allow the shoulder belt to retract until the child restraint system is securely in place.

After the shoulder belt has retracted to a point where there is no slack in the belt, pull the belt to check that it cannot be extended.

■ Junior seat

3-door models

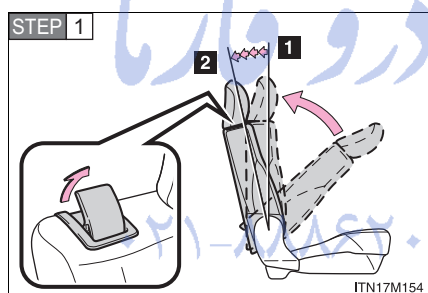

- 1 1st lock position
- 2 5th lock position

Fold the seatback forward and then back to the 1st lock position (most upright position) until it locks into place. Adjust the seatback to the 5th lock position.

5-door models

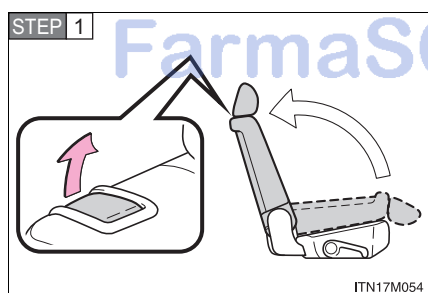

Fold the seatback forward. Then return the seatback and secure it at the first lock position (most upright position).

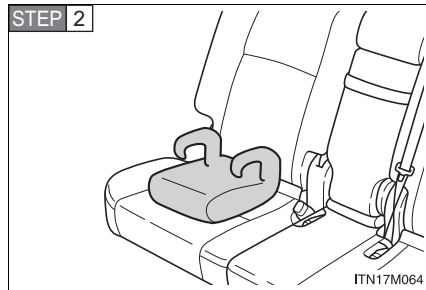

Place the child restraint system on the seat facing the front of the vehicle.

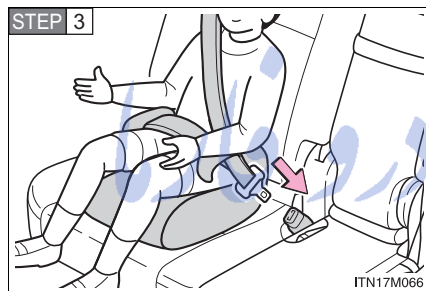

Sit the child in the child restraint system. Fit the seat belt to the child restraint system according to the manufacturer's instructions and insert the plate into the buckle. Make sure that the belt is not twisted.

Check that the shoulder belt is correctly positioned over the child's shoulder, and that the lap belt is as low as possible. (→P. 122)

1

Before driving

FarmaSOS.com

Removing a child restraint installed with a seat belt

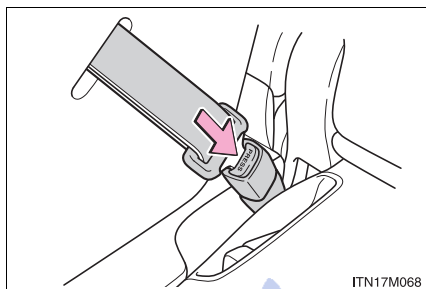

Push the buckle release button and fully retract the seat belt.

Installation with ISOFIX rigid anchors (ISOFIX child restraint system)

3-door models

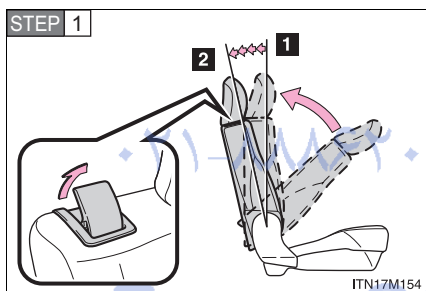

1 1st lock position

2 5th lock position

Fold the seatback forward and then back to the 1st lock position (most upright position) until it locks into place. Adjust the seatback to the 5th lock position.

5-door models

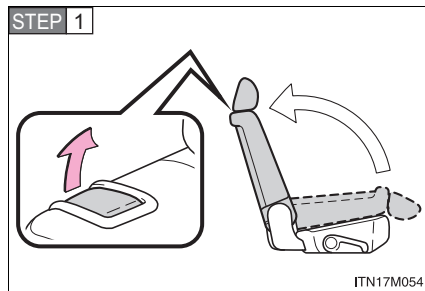

Fold the seatback forward. Then return the seatback and secure it at the first lock position (most upright position).

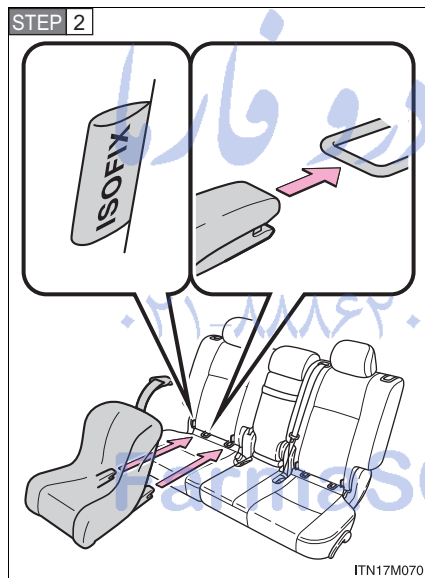

Flip the cover (3-door models and 5-door models with third power/manual seats), and latch the buckles onto the anchors.

If the child restraint has a top strap, the top strap should be latched onto the anchor bracket.

1

Before driving

Child restraint systems with a top strap

STEP 1 Secure the child restraint using a seat belt or ISOFIX rigid anchors, and do the following.

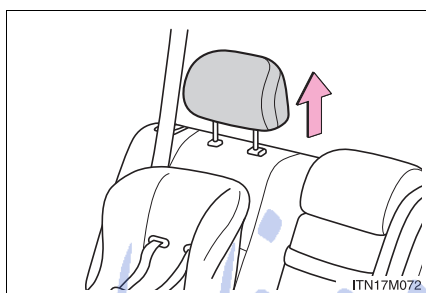

Move the head restraint in place at the upmost position.

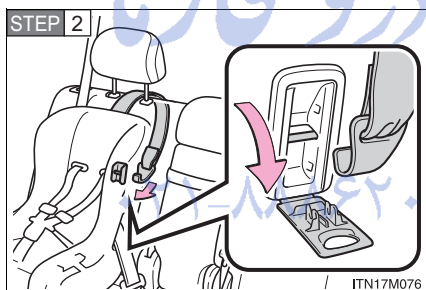

Open the anchor bracket cover, latch the hook onto the anchor bracket and tighten the top strap.

Make sure the top strap is securely latched.

■ When installing a child restraint system in the seat with ELR belt (→P. 197)

You need a locking clip to install the child restraint system. Follow the instructions provided by the manufacturer of the system. If your child restraint system does not provide a locking clip, you can purchase the following item from any authorized Toyota dealer or repairer, or another duly qualified and equipped professional:

Locking clip for child restraint system
(Part No. 73119-22010)

⚠ CAUTION**■ When installing a junior seat**

To prevent the belt from going into ALR lock mode, do not fully extend the shoulder belt. ALR mode causes the belt to tighten only. This could cause injury or discomfort to the child. (→P. 125)

■ When installing a child restraint system

Follow the directions given in the child restraint system installation manual and fix the child restraint system securely in place.

If the child restraint system is not correctly fixed in place, the child or other passengers may be seriously injured or even killed in the event of sudden braking, sudden swerving or an accident.

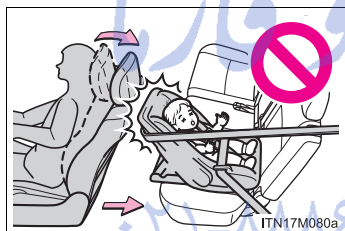

- If the driver's seat interferes with the child restraint system and prevents it from being attached correctly, attach the child restraint system to the right-hand second seat (left-hand drive vehicles) or the left-hand second seat (right-hand drive vehicles).

- Adjust the front passenger seat so that it does not interfere with the child restraint system.

- Child restraint system installed on the third seat should not contact the second seatbacks.

1

Before driving

⚠ CAUTION

■ **When installing a child restraint system**

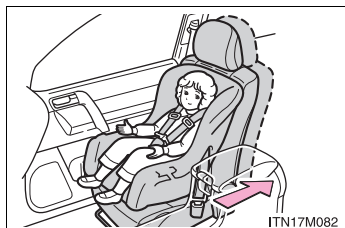

● **Vehicles without an airbag manual on-off switch**

Only put a forward facing child restraint system on the front seat when unavoidable.

● **When installing a forward-facing child restraint system on the front passenger seat, move the seat as far back as possible.**

Failing to do so may result in death or serious injury if the airbags deploy (inflate).

تلفن شبانه روزی: ۰۲۱-۸۸۶۲۰۸۵

FarmaSOS.com

CAUTION

■ **When installing a child restraint system**

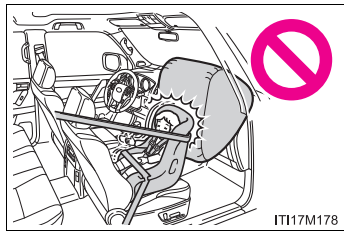

Vehicles without an airbag manual on-off switch

● **Vehicles without an airbag manual on-off switch**

Never install a rear-facing child restraint system on the front passenger seat.

● **Vehicles with an airbag manual on-off switch**

Never install a rear-facing child restraint system on the front passenger seat when the airbag manual on-off switch is on. (→P. 213)

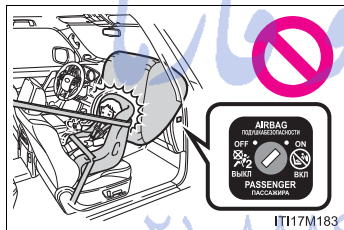

Vehicles with an airbag manual on-off switch

The force of the rapid inflation of the front passenger airbag can cause death or serious injury to children in the event of an accident.

1

Before driving

FarmaSOS.com

⚠ CAUTION

■ **When installing a child restraint system**

● On some models: There is a label(s) on the passenger side sun visor, indicating it is forbidden to attach a rear-facing child restraint system to the front passenger seat. Details of the label are shown in the illustration below.

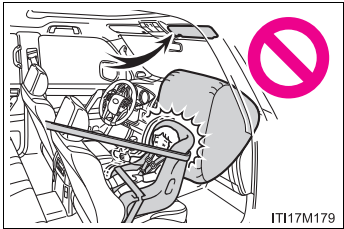

IT117M179

IT117118a

FarmaSOS.com

⚠ CAUTION**■ When installing a child restraint system**

- If child restraint system regulations exist in the country where you reside, please contact any authorized Toyota dealer or repairer, or another duly qualified and equipped professional for the child restraint system installation.
- When installing a child restraint system on the second center seat, adjust both seat cushions to the same position (vehicles with third manual/power seats) and align both seatbacks at the same angle. The seatbacks must be adjusted to the same angle. Otherwise, the child restraint system cannot be securely restrained and this may cause death or serious injuries in a collision.
- When a junior seat is installed, always ensure that the shoulder belt is positioned across the center of the child's shoulder. The belt should be kept away from the child's neck, but not so that it could fall off the child's shoulder. Failing to do so may result in death or serious injury in the event of sudden braking, sudden swerving or an accident.
- Ensure that the belt and plate are securely locked and the seat belt is not twisted.
- Push and pull the child restraint system from side to side and forward to be sure it is secure.
- After securing a child restraint system, never adjust the seat.
- Follow all installation instructions provided by the child restraint system manufacturer.

1

Before driving

⚠ CAUTION

■ **To correctly attach a child restraint system to the anchors**

- When using the lower anchors, be sure that there are no foreign objects around the anchors and that the seat belt is not caught behind the child restraint system. Make sure the child restraint system is securely attached, or it may cause death or serious injury to the child or other passengers in the event of sudden braking, sudden swerving or an accident.

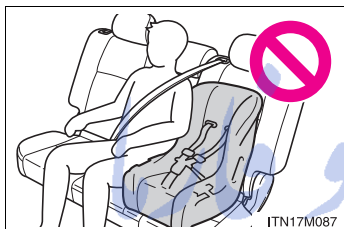

- When using the left side (left-hand drive vehicles) or right side (right-hand drive vehicles) lower anchors for the child restraint system, do not sit in the center seat.

Seat belt function may be impaired, such as being positioned overly high or loose-fitting, which may result in death or serious injury in the event of sudden braking, sudden swerving or an accident.

تلفن شبانه روزی: ۰۲۱-۸۸۶۲۰۸۵

FarmaSOS.com

1-7. Safety information

Airbag manual on-off system*

This system deactivates the front passenger airbag.

Only deactivate the airbag when using a child restraint system on the front passenger seat.

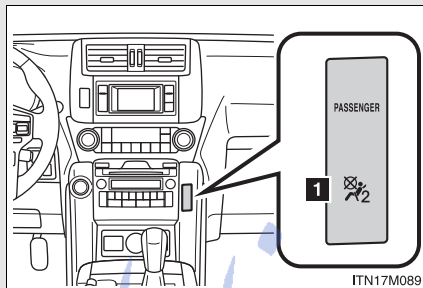

1 Airbag off indicator

This indicator light turns on when the "ENGINE START STOP" switch is in IGNITION ON mode.

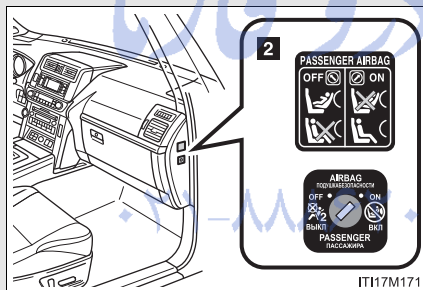

2 Airbag manual on-off switch

1

Before driving

FarmaSOS.com

*: If equipped

Deactivating the front seat passenger airbag

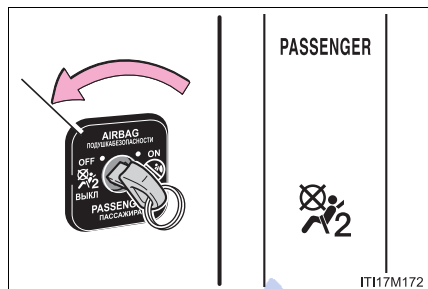

Insert the mechanical key into the cylinder and rotate to the "OFF" position.

The indicator light turns on (only when the "ENGINE START STOP" switch is in IGNITION ON mode).

■ Airbag off indicator

If any of the following problems occur, it is possible that there is a malfunction in the system. Have the vehicle inspected by any authorized Toyota dealer or repairer, or another duly qualified and equipped professional.

- The indicator light does not come on when the airbag manual on-off switch is switched to "OFF".
- The indicator light does not go off when the airbag manual on-off switch is switched to "ON".

FarmaSOS.com

⚠ CAUTION**■ When installing a child restraint system**

For safety reasons, always install the child restraint system in a rear seat. In the event that the rear seat cannot be used, the front seat can be used as long as the airbag manual on-off system is set to "OFF".

If the airbag manual on-off system is left on, the strong impact of the airbag deployment (inflation) may cause serious injury or even death.

■ When a child restraint system is not installed on the front passenger seat

Ensure that the airbag manual on-off system is set to "ON".

If it is left off, the airbag may not deploy in the event of an accident, which may result in serious injury or even death.

1

Before driving

تلفن شبانه روزی: ۰۲۱-۸۸۶۲۰۸۵

FarmaSOS.com

2-1. Driving procedures

Driving the vehicle	218
Engine (ignition) switch (vehicles without a smart entry & start system).....	235
Engine (ignition) switch (vehicles with a smart entry & start system).....	239
Automatic transmission	249
Manual transmission.....	258
Turn signal lever	263
Parking brake.....	264
Horn	265

FarmaSOS.com

<p>2-2. Instrument cluster</p> <p>Gauges and meters 266</p> <p>Indicators and warning lights 270</p> <p>Multi-information display (Non-Optitron type meters) 276</p> <p>Multi-information display (Optitron type meters) 282</p> <p>Multi-information display (Accessory meters)..... 292</p> <p>2-3. Operating the lights and wipers</p> <p>Headlight switch 300</p> <p>Fog light switch 312</p> <p>Windshield wipers and washer 314</p> <p>Rear window wiper and washer 320</p> <p>Headlight cleaner switch 322</p>	<p>2-4. Using other driving systems</p> <p>Cruise control..... 324</p> <p>Dynamic radar cruise control..... 328</p> <p>Toyota parking assist-sensor 345</p> <p>Rear view monitor system (vehicles with an accessory meter) 356</p> <p>Wide view front & side monitor (vehicles with an accessory meter) 361</p> <p>Driving assist systems 373</p> <p>PCS (Pre-Crash Safety system) 380</p> <p>Diesel Particulate Filter system (diesel engine only) 389</p> <p>2-5. Driving information</p> <p>Cargo and luggage 392</p> <p>Winter driving tips 396</p> <p>Trailer towing 400</p>
---	---

For details of equipment related to off-road driving, such as the four-wheel drive system, refer to the “Off-road Driving Owner’s Manual”.

2-1. Driving procedures

Driving the vehicle

The following procedures should be observed to ensure safe driving:

■ Starting the engine

→P. 235, 239

■ Driving

Automatic transmission

STEP 1 With the brake pedal depressed, shift the shift lever to D.
(→P. 249)

STEP 2 Release the parking brake. (→P. 264)

STEP 3 Gradually release the brake pedal and gently depress the accelerator pedal to accelerate the vehicle.

Manual transmission

STEP 1 While depressing the clutch pedal, shift the shift lever to 1.
(→P. 258)

STEP 2 Release the parking brake. (→P. 264)

STEP 3 Gradually release the clutch pedal. At the same time, gently depress the accelerator pedal to accelerate the vehicle.

■ Stopping

Automatic transmission

STEP 1 With the shift lever in D, depress the brake pedal.

STEP 2 If necessary, set the parking brake.

If the vehicle is to be stopped for an extended period of time, shift the shift lever to P or N. (→P. 249)

Manual transmission

STEP 1 While depressing the clutch pedal, depress the brake pedal.

STEP 2 If necessary, set the parking brake.

If the vehicle is to be stopped for an extended period of time, shift the shift lever to N. (→P. 258)

■ **Parking the vehicle**

Automatic transmission

STEP 1 With the shift lever in D, depress the brake pedal.

STEP 2 Set the parking brake. (→P. 264)

STEP 3 Shift the shift lever to P. (→P. 249)

If parking on a hill, block the wheels as needed.

STEP 4 Vehicles without a smart entry & start system

Turn the engine switch to the “LOCK” position to stop the engine.

Vehicles with a smart entry & start system

Press the “ENGINE START STOP” switch to stop the engine.

STEP 5 Lock the door, making sure that you have the key on your person.

2

When driving

Manual transmission

STEP 1 While depressing the clutch pedal, depress the brake pedal.

STEP 2 Set the parking brake. (→P. 264)

STEP 3 Shift the shift lever to N. (→P. 258)

If parking on a hill, shift the shift lever to 1 or R and block the wheels as needed.

STEP 4 **Vehicles without a smart entry & start system**

Turn the engine switch to the “LOCK” position to stop the engine.

Vehicles with a smart entry & start system

Press the “ENGINE START STOP” switch to stop the engine.

STEP 5 Lock the door, making sure that you have the key on your person.

تلفن شبانه روزی: ۰۲۱-۸۸۸۶۲۰۸۵

FarmaSOS.com

Starting off on a steep uphill

Automatic transmission

- STEP 1** Make sure that the parking brake is set and shift the shift lever to D.
- STEP 2** Gently depress the accelerator pedal.
- STEP 3** Release the parking brake.

Manual transmission

- STEP 1** With the parking brake firmly set and the clutch pedal fully depressed, shift the shift lever to 1.
- STEP 2** Lightly depress the accelerator pedal at the same time as gradually releasing the clutch pedal.
- STEP 3** Release the parking brake.

2

When driving

■ Driving in the rain

- Drive carefully when it is raining, because visibility will be reduced, the windows may become fogged-up, and the road will be slippery.
- Drive carefully when it starts to rain, because the road surface will be especially slippery.
- Refrain from high speeds when driving on an expressway in the rain, because there may be a layer of water between the tires and the road surface, preventing the steering and brakes from operating properly.

■ Engine speed while driving

In the following conditions, the engine speed may become high while driving. This is due to automatic up-shifting control or down-shifting implementation to meet driving conditions. It does not indicate sudden acceleration.

- The vehicle is judged to be driving uphill or downhill
- When the accelerator pedal is released

■ **Breaking in your new Toyota**

To extend the life of the vehicle, observing the following precautions is recommended:

- For the first 300 km (200 miles):
Avoid sudden stops.
- For the first 800 km (500 miles):
Do not tow a trailer.
- For the first 1000 km (600 miles):
 - Do not drive at extremely high speeds.
 - Avoid sudden acceleration.
 - Do not drive continuously in the low gears.
 - Do not drive at a constant speed for extended periods.
 - Do not drive slowly with the manual transmission in a high gear.

■ **Drum-in-disc type parking brake system**

Your vehicle has a drum-in-disc type parking brake system.

This type of brake system needs bedding-down of the brake shoes periodically or whenever the parking brake shoes and/or drum are replaced.

Have any authorized Toyota dealer or repairer, or another duly qualified and equipped professional, perform the bedding-down operation.

FarmaSOS.com

■ **Idling time before stopping the engine (diesel engine)**

To prevent damage to the turbocharger, allow the engine to idle immediately after high-speed driving or driving up a hill.

Driving condition		Idling time
Normal city driving		Not necessary
High-speed driving	Constant speed of approx. 80 km/h (50 mph)	Approximately 20 seconds
	Constant speed of approx. 100 km/h (63 mph)	Approximately 1 minute
Steep hill driving or continuous driving at 100 km/h (63 mph) or more (race track driving etc.)		Approximately 2 minutes

■ **Operating your vehicle in a foreign country**

Comply with the relevant vehicle registration laws and confirm the availability of the correct fuel. (→P. 818)

2

When driving

تلفن شبانه روزی: ۰۲۱-۸۸۶۲۰۸۵

FarmaSOS.com

■ **Eco-friendly driving (vehicles with an automatic transmission)**

Vehicles with a non-optitron type meters

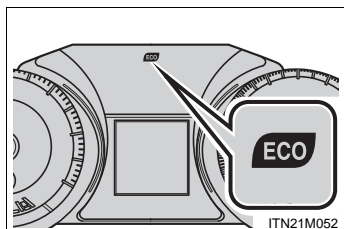

Vehicles with an optitron type meters

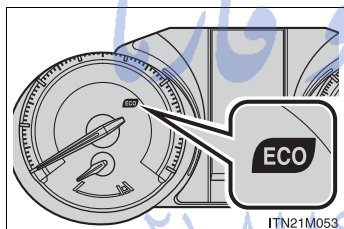

If Eco Driving Indicator Light turns on, it indicates that you are driving at Eco-friendly driving. In case of over-use of the accelerator that cause the vehicle to exceed Zone of Eco driving, Eco Driving Indicator Light will turn off.

Eco Driving Indicator Light will not operate in the following conditions:

- The shift lever is in anything other than D.
- The vehicle is set to second start mode. (→P. 252)
- The vehicle speed is approximately 130 km/h (81 mph) or higher.

⚠ CAUTION

■ **When starting the vehicle**

Always keep your foot on the brake pedal while stopped with the engine running. This prevents the vehicle from creeping.

⚠ CAUTION**■ When driving the vehicle**

- Do not drive if you are unfamiliar with the location of the brake and accelerator pedals to avoid depressing the wrong pedal.
 - Accidentally depressing the accelerator pedal instead of the brake pedal will result in sudden acceleration that may lead to an accident that could result in death or serious injury.
 - When backing up, you may twist your body around, leading to a difficulty in operating the pedals. Make sure to operate the pedals properly.
 - Make sure to keep a correct driving posture even when moving the vehicle only slightly. This allows you to depress the brake and accelerator pedals properly.
 - Depress the brake pedal using your right foot. Depressing the brake pedal using your left foot may delay response in an emergency, resulting in an accident.
- Do not drive the vehicle over or stop the vehicle near flammable materials. The exhaust system and exhaust gases can be extremely hot. These hot parts may cause a fire if there is any flammable material nearby.
- On vehicles with an automatic transmission, do not let the vehicle roll backwards while the shift lever is in a driving position, or roll forward while the shift lever is in R. Doing so may cause the engine to stall or lead to poor brake and steering performance, resulting in an accident or damage to the vehicle.
- If the smell of exhaust is noticed inside the vehicle, open the windows and check that the back door is closed. Large amounts of exhaust in the vehicle can cause driver drowsiness and an accident, resulting in death or a serious health hazard. Have the vehicle inspected by any authorized Toyota dealer or repairer, or another duly qualified and equipped professional immediately.

 CAUTION

■ **When driving the vehicle**

- On vehicles with an automatic transmission, do not shift the shift lever to P while the vehicle is moving.
Doing so can damage the transmission and may result in a loss of vehicle control.
- Do not shift the shift lever to R while the vehicle is moving forward.
Doing so can damage the transmission and may result in a loss of vehicle control.
- Do not shift the shift lever to D (vehicles with an automatic transmission) or 1 (vehicles with a manual transmission) while the vehicle is moving backward.
Doing so can damage the transmission and may result in a loss of vehicle control.
- Moving the shift lever to N while the vehicle is moving will disengage the engine from the transmission. Engine braking is not available when N is selected.
- During normal driving, do not turn off the engine. Turning the engine off while driving will not cause loss of steering or braking control, but the power assist to these systems will be lost. This will make it more difficult to steer and brake, so you should pull over and stop the vehicle as soon as it is safe to do so.
However, in the event of an emergency, such as if it becomes impossible to stop the vehicle in the normal way: →P. 809
- Use engine braking (downshift) to maintain a safe speed when driving down a steep hill.
Using the brakes continuously may cause the brakes to overheat and lose effectiveness. (→P. 251)

⚠ CAUTION**■ When driving the vehicle**

- Do not adjust the positions of the steering wheel, the seat, or the inside or outside rear view mirrors while driving.
Doing so may result in a loss of vehicle control that can cause accidents, resulting in death or serious injury.
- Always check that all passengers' arms, heads or other parts of their body are not outside the vehicle, as this may result in death or serious injury.

■ When driving on slippery road surfaces

- Sudden braking, acceleration and steering may cause tire slippage and reduce your ability to control the vehicle, resulting in an accident.
- Sudden changes in engine speed, such as engine braking caused by up-shifting and down-shifting, may cause the vehicle to skid, resulting in an accident.
- After driving through a puddle, lightly depress the brake pedal to make sure that the brakes are functioning properly. Wet brake pads may prevent the brakes from functioning properly. If the brakes on only one side are wet and not functioning properly, steering control may be affected, resulting in an accident.

■ When shifting the shift lever

On vehicles with an automatic transmission, be careful not to shift the shift lever with the accelerator pedal depressed. Shifting the shift lever to a gear other than P or N may lead to unexpected rapid acceleration of the vehicle that may cause an accident and result in death or serious injury.

 CAUTION

■ **If you hear a squealing or scraping noise (brake pad wear indicators)**

Have the brake pads checked and replaced by any authorized Toyota dealer or repairer, or another duly qualified and equipped professional as soon as possible.

Rotor damage may result if the pads are not replaced when needed.

It is dangerous to drive the vehicle when the wear limits of the brake pads and/or those of the brake discs are exceeded.

■ **When the vehicle is stopped**

- Do not race the engine.

If the vehicle is in any gear other than P (vehicles with an automatic transmission only) or N, the vehicle may accelerate suddenly and unexpectedly, causing an accident.

- Do not leave the vehicle with the engine running for a long time.

If such a situation cannot be avoided, park the vehicle in an open space and check that exhaust fumes do not enter the vehicle interior.

- In order to prevent accidents due to the vehicle rolling away, always keep depressing the brake pedal while the engine is running, and apply the parking brake as necessary.

- If the vehicle is stopped on an incline, in order to prevent accidents caused by the vehicle rolling forward or backward, always depress the brake pedal and securely apply the parking brake as needed.

- Avoid revving or racing the engine.

Running the engine at high speed while the vehicle is stopped may cause the exhaust system to overheat, which could result in a fire if combustible material is nearby.

⚠ CAUTION**■ When the vehicle is parked**

- Do not leave glasses, cigarette lighters, spray cans, or soft drink cans in the vehicle when it is in the sun.
Doing so may result in the following:
 - Gas may leak from a cigarette lighter or spray can, and may lead to a fire.
 - The temperature inside the vehicle may cause the plastic lenses and plastic material of glasses to deform or crack.
 - Soft drink cans may fracture, causing the contents to spray over the interior of the vehicle, and may also cause a short circuit in the vehicle's electrical components.
- Do not leave cigarette lighters in the vehicle. If a cigarette lighter is in a place such as the glove box or on the floor, it may be lit accidentally when luggage is loaded or the seat is adjusted, causing a fire.
- Do not attach adhesive discs to the windshield or windows. Do not place containers such as air fresheners on the instrument panel or dashboard. Adhesive discs or containers may act as lenses, causing a fire in the vehicle.
- Do not leave a door or window open if the curved glass is coated with a metallized film such as a silver-colored one. Reflected sunlight may cause the glass to act as a lens, causing a fire.
- Always apply the parking brake, shift the shift lever to P (vehicles with an automatic transmission only), stop the engine and lock the vehicle.
Do not leave the vehicle unattended while the engine is running.

 CAUTION

■ **When the vehicle is parked**

- Do not touch the exhaust pipes while the engine is running or immediately after turning the engine off. Doing so may cause burns.
- Do not leave the engine running in an area with snow build-up, or where it is snowing. If snowbanks build up around the vehicle while the engine is running, exhaust gases may collect and enter the vehicle. This may lead to death or a serious health hazard.

■ **Exhaust gases**

Exhaust gases include harmful carbon monoxide (CO), which is colorless and odorless. Inhaling exhaust gases may lead to death or a serious health hazard.

- If the vehicle is in a poorly ventilated area, stop the engine. In a closed area, such as a garage, exhaust gases may collect and enter the vehicle. This may lead to death or a serious health hazard.
- The exhaust system should be checked occasionally. If there is a hole or crack caused by corrosion, damage to a joint or abnormal exhaust noise, be sure to have the vehicle inspected and repaired by any authorized Toyota dealer or repairer, or another duly qualified and equipped professional. Failure to do so may allow exhaust gases to enter the vehicle, resulting in death or a serious health hazard.

⚠ CAUTION**■ When taking a nap in the vehicle**

Always turn the engine off. Otherwise, if you accidentally move the shift lever or depress the accelerator pedal, this could cause an accident or fire due to engine overheating. Additionally, if the vehicle is parked in a poorly ventilated area, exhaust gases may collect and enter the vehicle, leading to death or a serious health hazard.

■ When braking

- When the brakes are wet, drive more cautiously.
Braking distance increases when the brakes are wet, and this may cause one side of the vehicle to brake differently than the other side. Also, the parking brake may not securely hold the vehicle.
- If the power brake assist function does not operate, do not follow other vehicles closely and avoid hills or sharp turns that require braking. In this case, braking is still possible, but the brake pedal should be depressed more firmly than usual. Also, the braking distance will increase.
- Do not pump the brake pedal if the engine stalls.
Each push on the brake pedal uses up the reserve for the power-assisted brakes.
- The brake system consists of 2 individual hydraulic systems: If one of the systems fails, the other will still operate. In this case, the brake pedal should be depressed more firmly than usual and the braking distance will increase.
If this happens, do not continue to drive the vehicle. Have your brakes fixed immediately.

2

When driving

 NOTICE

■ **When driving the vehicle**

Automatic transmission

- Do not depress the accelerator and brake pedals at the same time during driving, as this may restrain driving torque.
- Do not use the accelerator pedal or depress the accelerator and brake pedals at the same time to hold the vehicle on a hill.

Manual transmission

- Do not depress the accelerator and brake pedals at the same time during driving, as this may restrain driving torque.
- Do not shift gears unless the clutch pedal is fully depressed. After shifting, do not release the clutch abruptly. Doing so may damage the clutch, transmission and gears.
- Observe the following to prevent the clutch from being damaged.
 - Do not rest your foot on the clutch pedal while driving.
 - Do not use any gears other than the 1st gear when starting off and moving forward.
 - Do not use the clutch to hold the vehicle when stopping on an uphill grade.
- Do not shift the shift lever to R when the vehicle is still moving. Doing so may damage the clutch, transmission and gears.

 NOTICE**■ When parking the vehicle**

On vehicles with an automatic transmission, always shift the shift lever to P. Failure to do so may cause the vehicle to move or the vehicle may accelerate suddenly if the accelerator pedal is accidentally depressed.

■ Avoiding damage to vehicle parts

- Do not turn the steering wheel fully in either direction and hold it there for an extended period of time.
Doing so may damage the power steering pump.
- When driving over bumps in the road, drive as slowly as possible to avoid damaging the wheels, underside of the vehicle, etc.
- Diesel engine only: Make sure to idle the engine immediately after high-speed driving or hill climbing. Stop the engine only after the turbocharger has cooled down.
Failure to do so may cause damage to the turbocharger.

■ If you get a flat tire while driving

A flat or damaged tire may cause the following situations. Hold the steering wheel firmly and gradually depress the brake pedal to slow down the vehicle.

- It may be difficult to control your vehicle.
- The vehicle will make abnormal sounds or vibrations.
- The vehicle will lean abnormally.

Information on what to do in case of a flat tire. (→P. 743, 765)

 NOTICE

■ **When encountering flooded roads**

Do not drive on a road that has flooded after heavy rain etc. Doing so may cause the following serious damage to the vehicle:

- Engine stalling
- Short in electrical components
- Engine damage caused by water immersion

In the event that you drive on a flooded road and the vehicle is flooded, be sure to have any authorized Toyota dealer or repairer, or another duly qualified and equipped professional check the following:

- Brake function
- Changes in quantity and quality of oil and fluid used for the engine, transmission, transfer, differentials, etc.
- Lubricant condition for the propeller shaft, bearings and suspension joints (where possible), and the function of all joints, bearings, etc.

تلفن شبانه روزی: ۰۲۱-۸۸۶۲۰۸۵

FarmaSOS.com

2-1. Driving procedures

Engine (ignition) switch (vehicles without a smart entry & start system)

■ Starting the engine

Automatic transmission

- STEP 1** Check that the parking brake is set.
- STEP 2** Check that the shift lever is set in P.
- STEP 3** Firmly depress the brake pedal.
- STEP 4** Turn the engine switch to the “START” position to start the engine.

Manual transmission

- STEP 1** Check that the parking brake is set.
- STEP 2** Check that the shift lever is set in N.
- STEP 3** Firmly depress the clutch pedal.
- STEP 4** Turn the engine switch to the “START” position to start the engine.

2

When driving

تلفن شبانه روزی: ۰۲۱-۸۸۶۲۰۸۵

FarmaSOS.com

■ Changing the engine switch positions

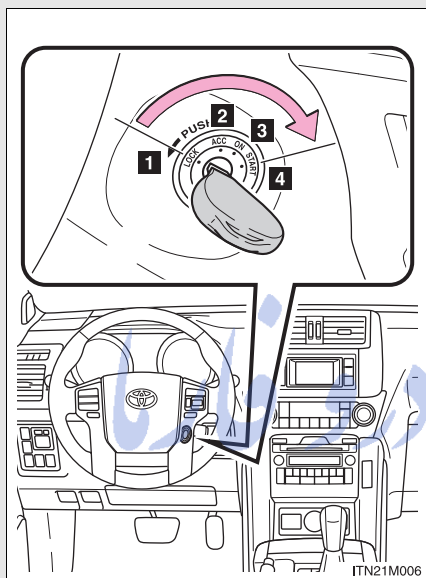

1 “LOCK”

The steering wheel is locked and the key can be removed. (Vehicles with an automatic transmission: The key can be removed only when the shift lever is in P.)

2 “ACC”

Some electrical components such as the audio system can be used.

3 “ON”

All electrical components can be used.

4 “START”

For starting the engine.

FarmaSOS.com

■ Turning the key from “ACC” to “LOCK”

STEP 1 Shift the shift lever to P (automatic transmission) or N (manual transmission). (→P. 249, 258)

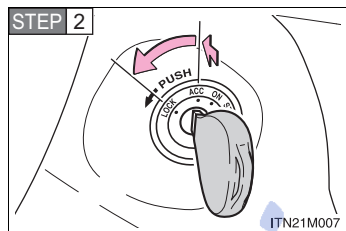

Push in the key and turn to the “LOCK” position.

■ If the engine does not start

The engine immobilizer system may not have been deactivated. (→P. 152)

■ When the steering lock cannot be released

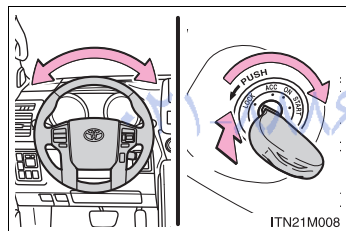

When starting the engine, the engine switch may seem stuck in the “LOCK” position. To free it, turn the key while turning the steering wheel slightly left and right.

■ Key reminder function

A buzzer sounds if the driver’s door is opened while the engine switch is in the “LOCK” or “ACC” position to remind you to remove the key.

 CAUTION

■ **When starting the engine**

Always start the engine while sitting in the driver's seat. Do not depress the accelerator pedal while starting the engine under any circumstances. Doing so may cause an accident resulting in death or serious injury.

■ **Caution when driving**

Do not turn the engine switch to the "LOCK" position while driving. If in an emergency, you must turn the engine off while the vehicle is moving, turn the engine switch only to the "ACC" position to stop the engine. An accident may result if the engine is stopped while driving.

 NOTICE

■ **To prevent battery discharge**

Do not leave the engine switch in the "ACC" or "ON" position for long periods of time without the engine running.

■ **When starting the engine**

- Do not crank the engine for more than 30 seconds at a time. This may overheat the starter and wiring system.
- Do not race a cold engine.
- If the engine becomes difficult to start or stalls frequently, have the engine checked immediately.

2-1. Driving procedures

Engine (ignition) switch (vehicles with a smart entry & start system)

Performing the following operations when carrying the electronic key on your person starts the engine or changes “ENGINE START STOP” switch modes.

■ Location of the “ENGINE START STOP” switch

Left-hand drive vehicles

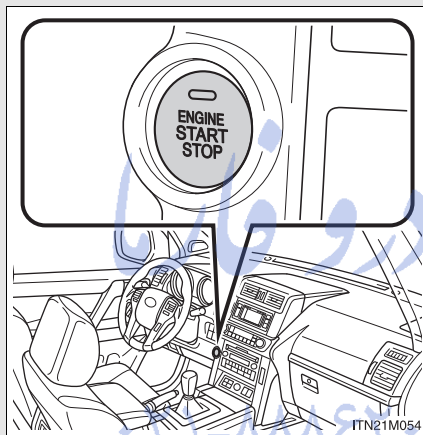

Right-hand drive vehicles

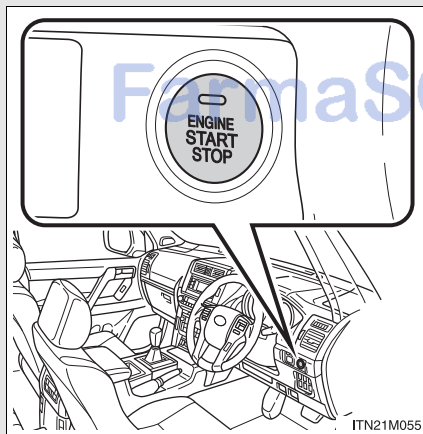

■ Starting the engine

Automatic transmission

STEP 1 Check that the parking brake is set.

STEP 2 Check that the shift lever is set in P.

STEP 3 Firmly depress the brake pedal.

The “ENGINE START STOP” switch indicator will turn green.
If the indicator does not turn green, the engine cannot be started.

STEP 4 Press the “ENGINE START STOP” switch.

The engine will crank until it starts or for up to 30 seconds, whichever is less.

Continue depressing the brake pedal until the engine is completely started.

Diesel engine only: the  indicator turns on. The engine will start after the indicator light goes out.

The engine can be started from any “ENGINE START STOP” switch mode.

تلفن شبانه روزی: ۰۲۱-۸۸۶۲۰۸۵

FarmaSOS.com

Manual transmission

STEP 1 Check that the parking brake is set.

STEP 2 Check that the shift lever is set in N.

STEP 3 Firmly depress the clutch pedal.

The “ENGINE START STOP” switch indicator will turn green.
If the indicator does not turn green, the engine cannot be started.

STEP 4 Press the “ENGINE START STOP” switch.

The engine will crank until it starts or for up to 30 seconds, whichever is less.

Continue depressing the clutch pedal until the engine is completely started.

The  indicator turns on. The engine will start after the indicator light goes out.

The engine can be started from any “ENGINE START STOP” switch mode.

2

When driving

تلفن شبانه روزی: ۰۲۱-۸۸۶۲۰۸۵

FarmaSOS.com

■ **Stopping the engine**

Automatic transmission

- STEP 1 Stop the vehicle.
- STEP 2 Shift the shift lever to P.
- STEP 3 Set the parking brake. (→P. 264)
- STEP 4 Press the “ENGINE START STOP” switch.
- STEP 5 Release the brake pedal and check that the indicator on the “ENGINE START STOP” switch is off.

Manual transmission

- STEP 1 Stop the vehicle.
- STEP 2 Shift the shift lever to N.
- STEP 3 Set the parking brake. (→P. 264)
- STEP 4 Press the “ENGINE START STOP” switch.
- STEP 5 Release the brake pedal and check that the indicator on the “ENGINE START STOP” switch is off.

FarmaSOS.com

■ Changing “ENGINE START STOP” switch modes

Modes can be changed by pressing the “ENGINE START STOP” switch with brake pedal (vehicles with an automatic transmission) or clutch pedal (vehicles with a manual transmission) released. (The mode changes each time the switch is pressed.)

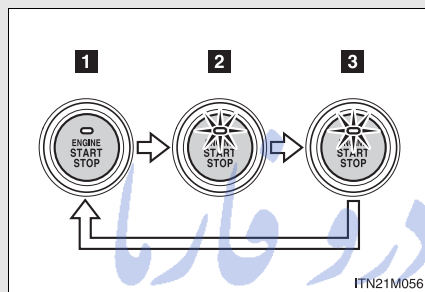

1 Off*

The emergency flashers can be used.

2 ACCESSORY mode

Some electrical components such as the audio system can be used.

The “ENGINE START STOP” switch indicator turns amber.

3 IGNITION ON mode

All electrical components can be used.

The “ENGINE START STOP” switch indicator turns green.

*: If the shift lever is in a position other than P when turning off the engine, the “ENGINE START STOP” switch will be turned to ACCESSORY mode, not to OFF (vehicles with an automatic transmission only).

2

When driving

When stopping the engine with the shift lever in a position other than P (Vehicles with an automatic transmission)

If the engine is stopped with the shift lever in a position other than P, the “ENGINE START STOP” switch will not be turned off but instead be turned to ACCESSORY mode. Perform the following procedure to turn the switch off:

- STEP 1** Check that the parking brake is set.
- STEP 2** Shift the shift lever to P.
- STEP 3** Check that the indicator on the “ENGINE START STOP” switch is illuminated in amber and then press the “ENGINE START STOP” switch once.
- STEP 4** Check that the indicator on the “ENGINE START STOP” switch is off.

تلفن شبانه روزی: ۰۲۱-۸۸۶۲۰۸۵

FarmaSOS.com

■ Auto power off function

Vehicles with an automatic transmission

When the shift lever is in P, if the vehicle is left in ACCESSORY or IGNITION ON mode with the engine not running for more than 20 minutes (ACCESSORY mode) or one hour (IGNITION ON mode), the “ENGINE START STOP” switch will automatically turn off. However, this function cannot entirely prevent battery discharge. Do not leave the vehicle with the “ENGINE START STOP” switch in ACCESSORY or IGNITION ON mode for long periods of time when the engine is not running.

Vehicles with a manual transmission

If the vehicle is left in ACCESSORY or IGNITION ON mode with the engine not running for more than 20 minutes (ACCESSORY mode) or one hour (IGNITION ON mode), the “ENGINE START STOP” switch will automatically turn off. However, this function cannot entirely prevent battery discharge. Do not leave the vehicle with the “ENGINE START STOP” switch in ACCESSORY or IGNITION ON mode for long periods of time when the engine is not running.

■ Operation of the “ENGINE START STOP” switch

When operating the “ENGINE START STOP” switch, one short, firm press is enough. If the switch is pressed improperly, the engine may not start or the “ENGINE START STOP” switch mode may not change. It is not necessary to press and hold the switch.

■ Electronic key battery depletion

→P. 56

■ Conditions affecting operation

→P. 51

■ Note for the entry function

→P. 53

■ **If the engine does not start**

The engine immobilizer system may not have been deactivated. (→P. 152)

■ **Steering lock**

After turning the “ENGINE START STOP” switch off and opening and closing the doors, the steering wheel will be locked due to the steering lock function. Operating the “ENGINE START STOP” switch again automatically cancels the steering lock.

■ **When the steering lock cannot be released**

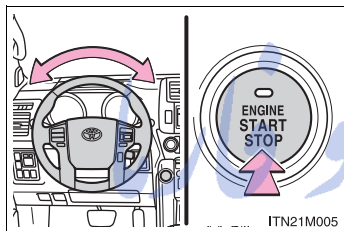

The green indicator light on the “ENGINE START STOP” switch will flash and a message will be shown on the multi-information display. Press the “ENGINE START STOP” switch again while turning the steering wheel left and right.

■ **Steering lock motor overheating prevention**

To prevent the steering lock motor from overheating, the motor may be suspended if the engine is turned on and off repeatedly in a short period of time. In this case, refrain from operating the engine. After about 10 seconds, the steering lock motor will resume functioning.

■ **When the “ENGINE START STOP” switch indicator flashes in amber**

The system may be malfunctioning. Have the vehicle inspected by any authorized Toyota dealer or repairer, or another duly qualified and equipped professional immediately.

■ **If the electronic key battery is depleted**

→P. 656

⚠ CAUTION**■ When starting the engine**

Always start the engine while sitting in the driver's seat. Do not depress the accelerator pedal while starting the engine under any circumstances. Doing so may cause an accident resulting in death or serious injury.

■ Caution while driving

If the vehicle begins to slide due to engine failure or other circumstances, do not lock or open the doors until the vehicle reaches a safe and complete stop. Activation of the steering lock in this circumstance may lead to an accident, resulting in death or serious injury.

■ Stopping the engine in an emergency

If you want to stop the engine in an emergency while driving the vehicle, press and hold the "ENGINE START STOP" switch for more than 2 seconds, or press it briefly 3 times or more in succession.

However, do not touch the "ENGINE START STOP" switch while driving except in an emergency. Turning the engine off while driving will not cause loss of steering or braking control, but the power assist to these systems will be lost. This will make it more difficult to steer and brake, so you should pull over and stop the vehicle as soon as it is safe to do so. تلفن شبانه روزی: 021-88888888

2

When driving

FarmaSOS.com

 NOTICE

■ **To prevent battery discharge**

- Do not leave the “ENGINE START STOP” switch in ACCESSORY or IGNITION ON mode for long periods of time without the engine running.
- If the indicator on the “ENGINE START STOP” switch is illuminated, the “ENGINE START STOP” switch is not off. When exiting the vehicle, always check that the “ENGINE START STOP” switch is off.
- On vehicles with an automatic transmission, do not stop the engine when the shift lever is in a position other than P. If the engine is stopped in another shift lever position, the “ENGINE START STOP” switch will not be turned off but instead be turned to ACCESSORY mode. If the vehicle is left in ACCESSORY mode, battery discharge may occur.

■ **When starting the engine**

- Do not race a cold engine.
- If the engine becomes difficult to start or stalls frequently, have the engine checked immediately.

■ **Symptoms indicating a malfunction with the “ENGINE START STOP” switch**

If the “ENGINE START STOP” seems to be operating somewhat differently than usual, such as the switch sticking slightly, there may be a malfunction. Contact any authorized Toyota dealer or repairer, or another duly qualified and equipped professional.

2-1. Driving procedures

Automatic transmission*

Select a shift position appropriate for the driving conditions.

■ Shifting the shift lever

Standard type

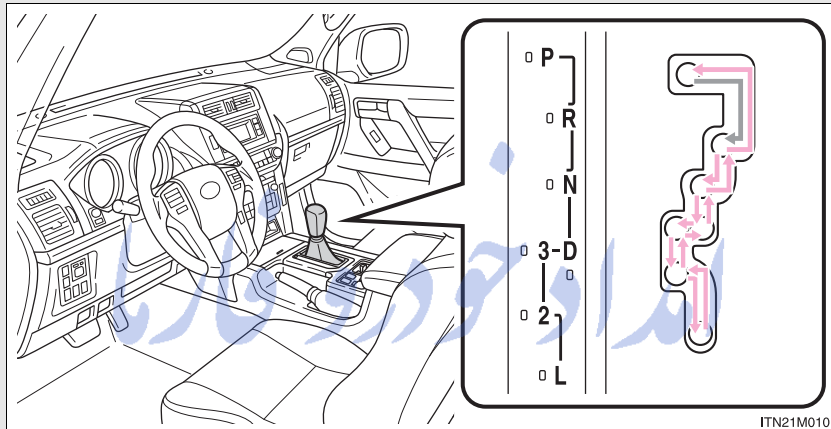

- ← While the engine switch is in the “ON” position, move the shift lever with the brake pedal depressed. *تلفن شبانه ۰۰۰۰۰۰۰۰۰۰*
- When shifting the shift lever between P and D, make sure that the vehicle is completely stopped.

2

When driving

FarmaSOS.com

*: If equipped

Multi-mode type

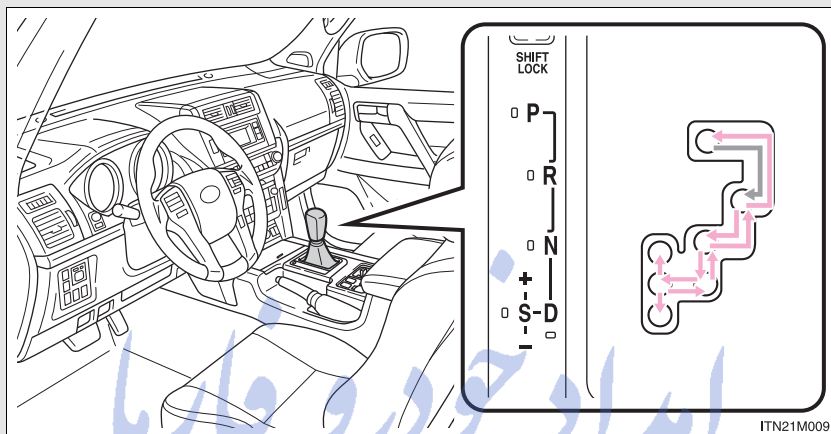

← While the “ENGINE START STOP” switch is in IGNITION ON mode, move the shift lever with the brake pedal depressed.

When shifting the shift lever between P and D, make sure that the vehicle is completely stopped.

FarmaSOS.com

■ Shift position purpose

Shift position	Function	
	Standard type	Multi-mode type
P	Parking the vehicle/starting the engine	
R	Reversing	
N	Neutral	
D	Normal driving* ¹	
S	—	S mode driving* ² (→P. 254)
3	Position for engine braking	—
2	Position for more powerful engine braking	—
L	Position for maximum engine braking	—

*1: Shifting to the D position allows the system to select a gear suitable for the driving conditions. Setting the shift lever to the D position is recommended for normal driving.

*2: Selecting shift ranges using S mode restricts the upper limit of the possible gear ranges, controls engine braking forces, and prevents unnecessary upshifting.

2

When driving

■ **Selecting the second start mode**

Use second start mode for accelerating and driving on slippery road surfaces such as snow.

Non-Optitron type meters

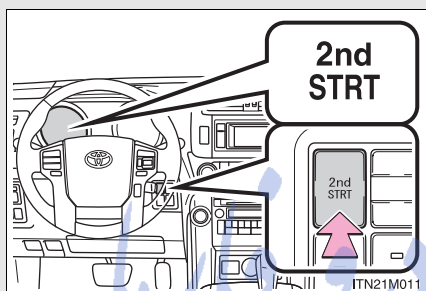

Turn the “2nd STRT” button on.

Press the button again to cancel second start mode.

تلفن شبانه روزی: ۰۲۱-۸۸۶۲۰۸۵

FarmaSOS.com

Optitron type meters

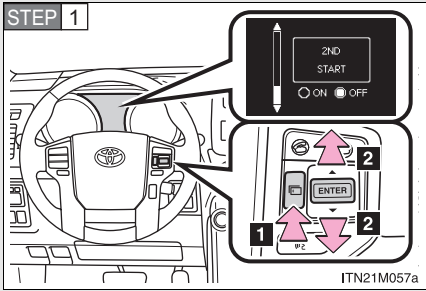

1 Press the menu switch.

The multi-information display will change modes to electronic features control mode.

2 Press the “ENTER” switch upwards or downwards until “2ND START” appears.

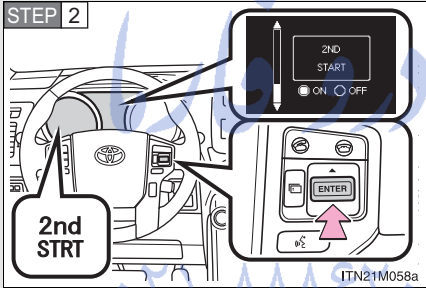

Press the “ENTER” switch to change to “ON”.

The “2nd STRT” indicator will be displayed.

Each pressing of the switch turns second start mode on and off.

Press the menu switch to change to the normal display.

2

When driving

Changing shift ranges in S mode (multi-mode type)

When the shift lever is in the S position, the shift lever can be operated as follows:

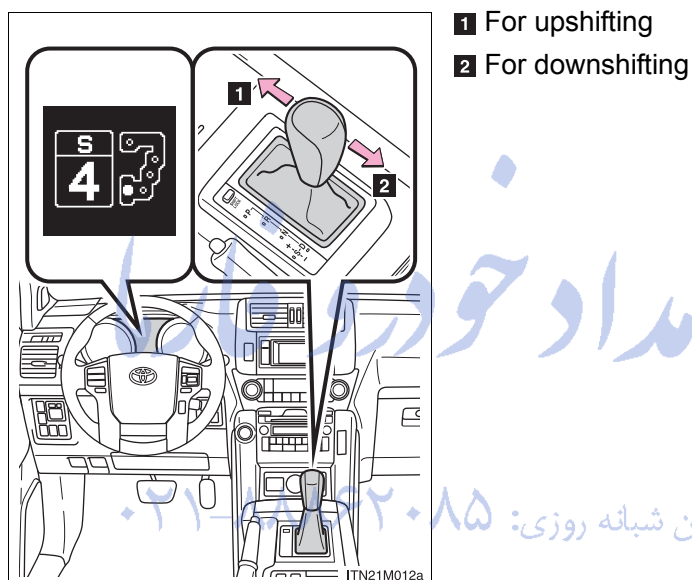

The initial shift range in S mode is set automatically to 4 according to vehicle speed. However, the initial shift range may be set to 3 if AI-SHIFT has operated while the shift lever was in the D position.
(→P. 256)

■ Shift ranges and their functions

- You can choose from 5 level of engine braking force.
- A lower shift range will provide greater engine braking force than a higher shift range, and the engine speed will also increase.

■ Downshifting restrictions (standard type)

The maximum allowable speeds are as follows.

Downshifting	Transfer position	Maximum speed km/h (mph)
3 → 2	H4	105 (65)
	L4	35 (22)
2 → 1	H4	50 (32)
	L4	10 (6)

■ Driving on a downhill

On declines, there may be case where the vehicle shifts down automatically to obtain engine braking. As a result of the downshifting, the engine speed may increase.

■ Second start mode automatic deactivation

Second start mode is automatically deactivated if the engine is turned off after driving in second start mode.

■ **S mode (multi-mode type)**

When the shift range is 4 or lower, holding the shift lever toward “+” sets the shift range to 5.

■ **AI-SHIFT**

AI-SHIFT automatically selects a suitable gear according to driver performance and driving conditions.

AI-SHIFT automatically operates when the shift lever is in the D position. (multi-mode type: Shifting the shift lever to the S position cancels the function.)

■ **When driving with the cruise control or dynamic radar cruise control (multi-mode type)**

Engine braking will not occur in S mode, even when downshifting to 4. (→P. 324, 328)

■ **If the shift lever cannot be shifted from P**

→P. 789

تلفن شبانه روزی: ۰۲۱-۸۸۶۲۰۸۵

FarmaSOS.com

■ **If the “S” indicator does not come on even after shifting the shift lever to S (multi-mode type)**

This may indicate a malfunction in the automatic transmission system. Have the vehicle inspected by any authorized Toyota dealer or repairer, or another duly qualified and equipped professional immediately.

(In this situation, the transmission will operate in the same manner as when the shift lever is in D.)

■ **Downshift restriction warning buzzer (S mode in multi-mode type)**

To help ensure safety and driving performance, downshifting operation may sometimes be restricted. In some circumstances, downshifting may not be possible even when the shift lever is operated. (A buzzer will sound twice.)

 **CAUTION**

■ **When driving on slippery road surfaces**

Do not accelerate or shift gears suddenly.

Sudden changes in engine braking may cause the vehicle to spin or skid, resulting in an accident.

2

When driving

فارفارما
تلفن شبانه روزی: ۰۲۱-۸۸۶۲۰۸۵
FarmaSOS.com

2-1. Driving procedures

Manual transmission*

■ Shifting the shift lever

5-speed transmission

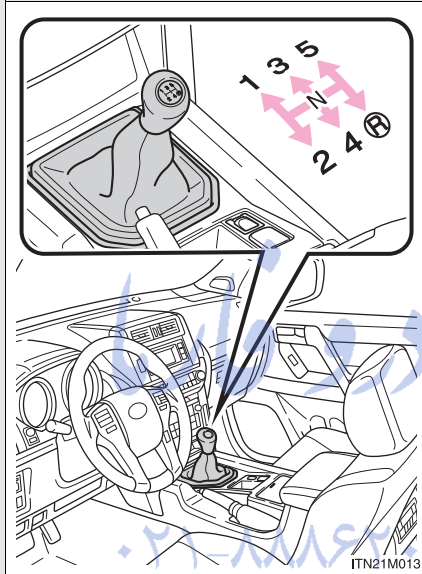

Fully depress the clutch pedal before operating the shift lever, and then release it slowly.

If it is difficult to shift in reverse, shift the shift lever to N, release the clutch pedal momentarily, and then try again.

FarmaSOS.com

*: If equipped

6-speed transmission

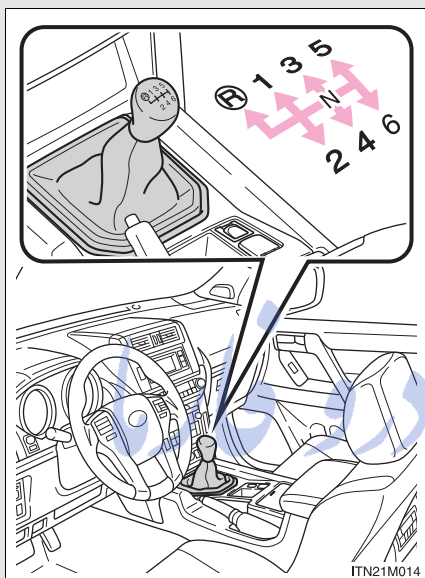

Fully depress the clutch pedal before operating the shift lever, and then release it slowly.

2

When driving

تلفن شبانه روزی: ۰۲۱-۸۸۶۲۰۸۵

FarmaSOS.com

Gear Shift Indicator (if equipped)

The Gear Shift Indicator display is a guide to help the driver achieve improved fuel economy and reduced exhaust emissions within limits of engine performance.

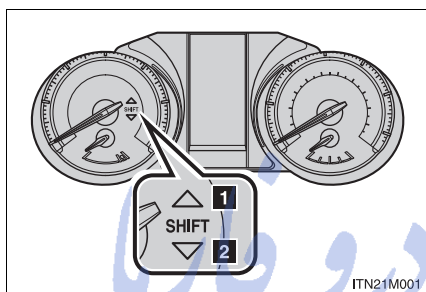

- 1 Upshifting
- 2 Downshifting

■ Gear Shift Indicator display

- The Gear Shift Indicator will not be displayed when the four-wheel drive control switch is in L4.
- The Gear Shift Indicator may not be displayed when your foot is placed on the clutch pedal.

FarmaSOS.com

■ Maximum downshifting speeds

Observe the downshifting speeds in the following table to prevent over-revving the engine.

5-speed transmission

Shift position	Maximum speed (km/h [mph])	
	Transfer position H4	Transfer position L4
1	45 (28)	17 (11)
2	112 (70)	44 (27)
3	119 (74)	46 (29)
4	165 (103)	67 (42)

6-speed transmission (5-door models)

Shift position	Maximum speed (km/h [mph])	
	Transfer position H4	Transfer position L4
1	38 (24)	15 (9)
2	77 (48)	30 (19)
3	105 (65)	41 (25)
4	131 (81)	51 (32)
5	157 (98)	61 (38)

2

When driving

6-speed transmission (3-door models)

Shift position	Maximum speed (km/h [mph])	
	Transfer position H4	Transfer position L4
1	38 (24)	15 (9)
2	102 (63)	40 (25)
3	105 (65)	41 (25)
4	131 (81)	51 (32)
5	157 (98)	61 (38)

■ **Reverse warning buzzer (vehicles with a 6-speed transmission)**

A buzzer will sound to alert the driver if the shift lever is shifted to the R position.

<p>⚠ CAUTION</p>
<p>■ Gear Shift Indicator display</p> <p>Refer to the display while considering actual traffic and road conditions. Failure to exercise judgment may lead to an accident.</p>

FarmaSOS.com

2-1. Driving procedures

Turn signal lever

The turn signal lever can be used to show the following intentions of the driver:

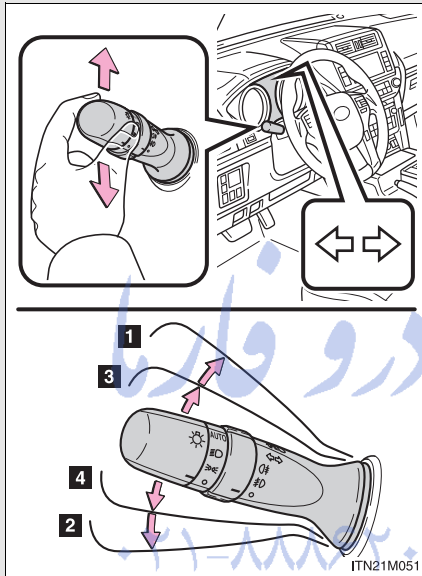

- 1 Right turn
- 2 Left turn
- 3 Lane change to the right (push and hold the lever partway)

The right hand signals will flash until you release the lever.

- 4 Lane change to the left (push and hold the lever partway)

The left hand signals will flash until you release the lever.

2

When driving

■ Turn signals can be operated when

Vehicles without a smart entry & start system

The engine switch is in the "ON" position.

Vehicles with a smart entry & start system

The "ENGINE START STOP" switch is in IGNITION ON mode.

■ If the indicator flashes faster than usual

Check that a light bulb in the front or rear turn signal lights has not burned out.

2-1. Driving procedures

Parking brake

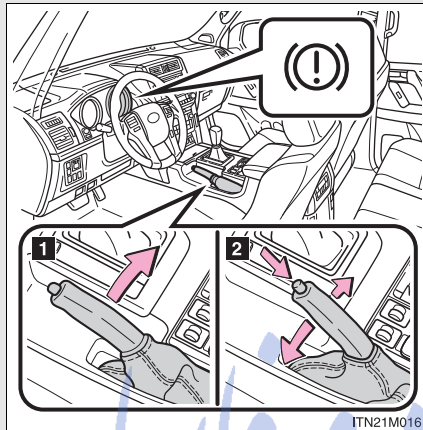

- 1** To set the parking brake, fully pull the parking brake lever while depressing the brake pedal.
- 2** To release the parking brake, slightly raise the lever and lower it completely while pressing the button.

■ Usage in winter time

See “Winter driving tips” for parking brake usage in winter time. (→P. 396)

⚠ NOTICE

■ Before driving

Fully release the parking brake.

Driving the vehicle with the parking brake set will lead to brake components overheating, which may affect braking performance and increase brake wear.

2-1. Driving procedures

Horn

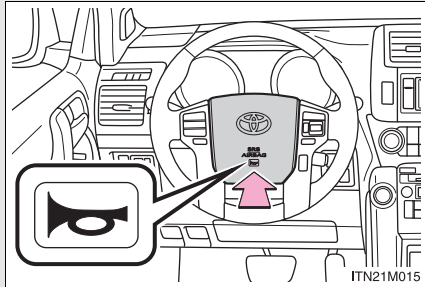

To sound the horn, press on or close to the  mark.

2

When driving

■ After adjusting the steering wheel (vehicles with manual adjustment type steering wheel)

Make sure that the steering wheel is securely locked.

The horn may not sound if the steering wheel is not securely locked.

(→P. 129)

تلفن شبانه روزی: ۰۲۱-۸۸۶۲۰۸۵

FarmaSOS.com

2-2. Instrument cluster Gauges and meters

Non-Optitron type meters

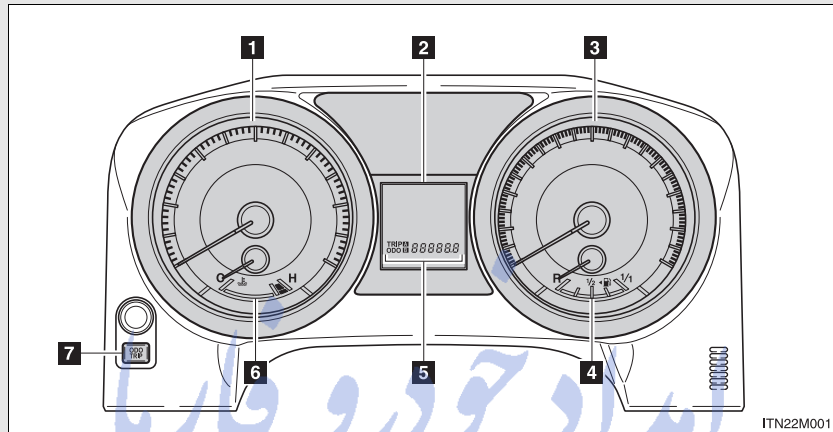

Optitron type meters

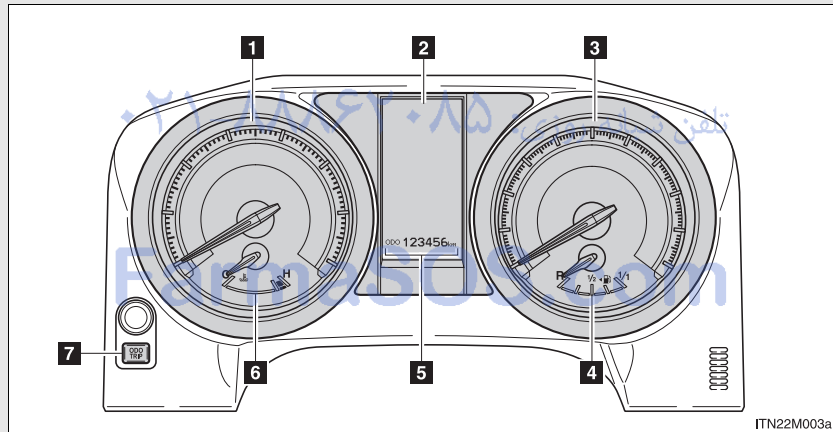

1 Tachometer

Displays the engine speed in revolutions per minute.

2 Multi-information display

→P. 276, 282

3 Speedometer

Displays the vehicle speed.

4 Fuel gauge

Displays the quantity of fuel remaining in the tank.

5 Odometer and trip meter display

Odometer: Displays the total distance the vehicle has been driven.

Trip meter: Displays the distance the vehicle has been driven since the meter was last reset. Trip meters A and B can be used to record and display different distances independently.

6 Engine coolant temperature gauge

Displays the engine coolant temperature.

7 Odometer/trip meter display change button

→P. 268

2

When driving

FarmaSOS.com

Changing the display

Non-Optitron type meter (→P. 276)

Optitron type meter

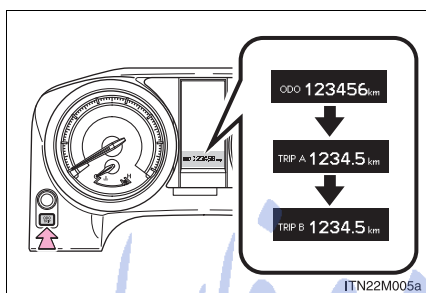

Switches between odometer and trip meter displays. When the trip meter is displayed, pressing and holding the button will reset the trip meter.

Instrument cluster light control

The brightness of the instrument cluster lights can be adjusted by turning the knob.

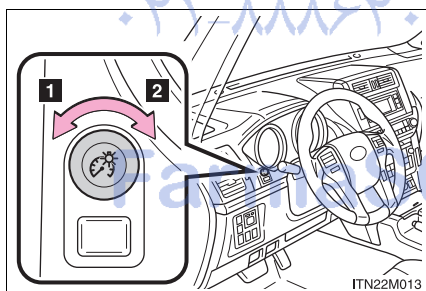

- 1** Darker
- 2** Brighter

■ **The meters and display illuminate when**

Vehicles without a smart entry & start system

The engine switch is in the “ON” position.

Vehicles with a smart entry & start system

The “ENGINE START STOP” switch is in IGNITION ON mode.

■ **The brightness of the instrument cluster lights**

Vehicles with a non-optitron type meter

When the headlight switch is turned to on, the brightness will be reduced slightly.

Vehicles with an optitron type meter

When the headlight switch is turned to on, the brightness will be reduced slightly unless the control dial is turned fully clockwise.

■ **When disconnecting and reconnecting battery terminals**

The trip meter data will be reset.

If the trip meter was displayed last, the ODO screen will be displayed after resetting.

2

When driving



NOTICE

■ **To prevent damage to the engine and its components**

- Do not let the indicator needle of the tachometer enter the red zone, which indicates the maximum engine speed.
- The engine may be overheating if the engine coolant temperature gauge is in the red zone (H). In this case, immediately stop the vehicle in a safe place, and check the engine after it has cooled completely. (→P. 803)

2-2. Instrument cluster Indicators and warning lights

The indicators and warning lights on the instrument cluster and center panel inform the driver of the status of the vehicle's various systems.

Instrument cluster (non-optitron type meters)

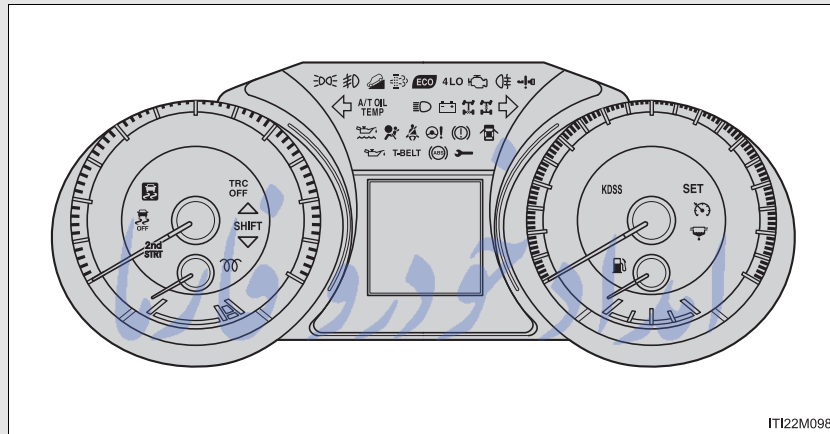

IT122M098

Instrument cluster (optitron type meters)

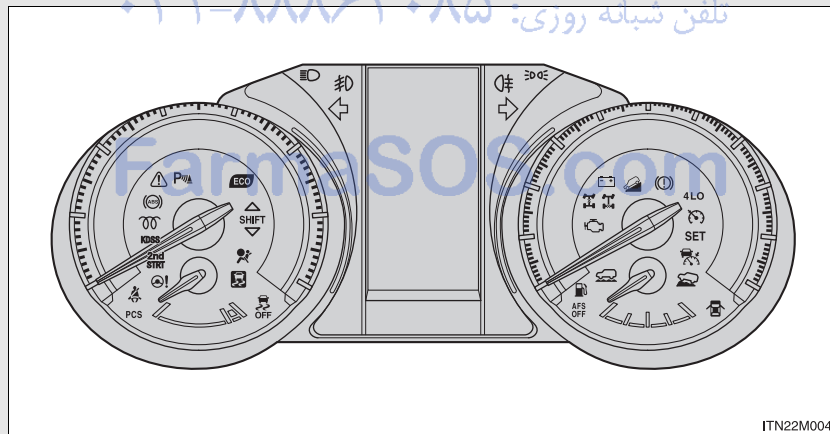

ITN22M004

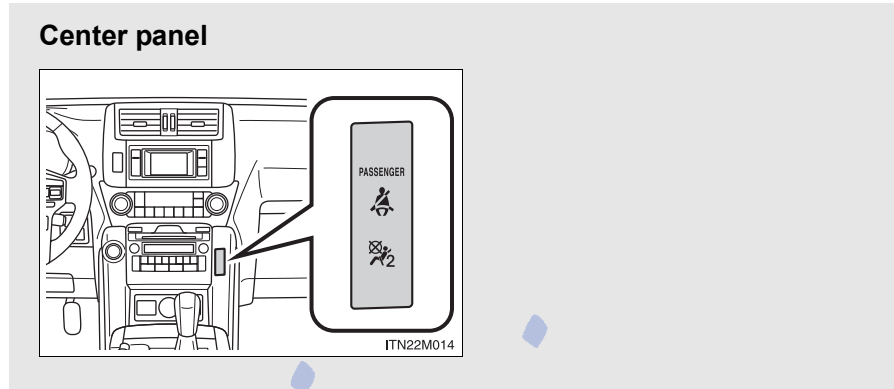

2

When driving

















امداد خودرو فارما











تلفن شبانه روزی: ۰۲۱-۸۸۸۶۲۰۸۵

FarmaSOS.com

■ Indicators

The indicators inform the driver of the operating state of the vehicle's various systems.

	Turn signal indicator (→P. 263)		"SET" indicator (→P. 324, 328)
	Headlight high beam indicator (→P. 300)		Dynamic radar cruise control indicator (→P. 328)
	Tail light indicator (→P. 300)		*1 Slip indicator*2 (→P. 374)
	Front fog light indicator (→P. 312)		*1 VSC OFF indicator*2 (→P. 375)
	Rear fog light indicator (→P. 312)		*1 "TRC OFF" indicator*2 (→P. 375)
	*1 Eco Driving Indicator Light (→P. 280, 289)		Engine preheating indicator (→P. 240)
	*1 Gear Shift Indicator (→P. 260)		Multi-terrain Select indicator*2
	Cruise control indicator (→P. 324, 328)		*1 Crawl Control indicator*2

<p> *1 (if equipped)</p>	<p>Downhill assist control system indicator *2</p>	<p> *1 (if equipped)</p>	<p>Airbag manual off indicator (→P. 213)</p>
<p> (automatic transmission)</p>	<p>Automatic transmission second start indicator (→P. 252)</p>	<p> (if equipped)</p>	<p>Toyota parking assist-sensor indicator (→P. 345)</p>
<p></p>	<p>Low speed four-wheel drive indicator light *2</p>	<p> *1 (if equipped)</p>	<p>“AFS OFF” indicator (→P. 307)</p>
<p> (if equipped)</p>	<p>Rear differential lock indicator *2</p>	<p> *1 (if equipped)</p>	<p>DPF system warning light (→P. 389)</p>
<p> (if equipped)</p>	<p>Center differential lock indicator *2</p>	<p> *1, 3 (if equipped)</p>	<p>Pre-crash safety system warning light (→P. 380)</p>

*1: These lights turn on when the engine switch is turned to the “ON” position (vehicles without a smart entry & start system) or the “ENGINE START STOP” switch is turned to IGNITION ON mode (vehicles with a smart entry & start system) to indicate that a system check is being performed. They will turn off after the engine is started, or after a few seconds. There may be a malfunction in a system if a light does not turn on, or if the lights do not turn off. Have the vehicle inspected by any authorized Toyota dealer or repairer, or another duly qualified and equipped professional.

*2: Refer to the “Off-road Driving Owner’s Manual”

*3: The light turns on when the system is turned off. The light flashes quickly to indicate that the system is operating.

2

When driving

■ **Warning lights**

Warning lights inform the driver of malfunctions in any of the vehicle's systems. (→P. 703)

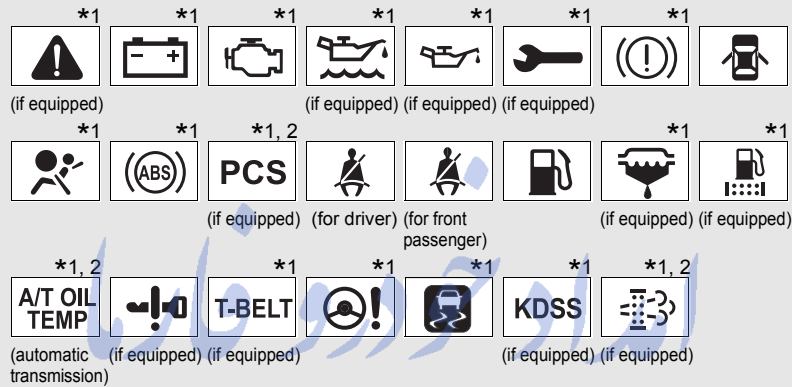

*1: These lights turn on when the engine switch is turned to the “ON” position (vehicles without a smart entry & start system) or the “ENGINE START STOP” switch is turned to IGNITION ON mode (vehicles with a smart entry & start system) to indicate that a system check is being performed. They will turn off after the engine is started, or after a few seconds. There may be a malfunction in a system if a light does not turn on, or if the lights do not turn off. Have the vehicle inspected by any authorized Toyota dealer or repairer, or another duly qualified and equipped professional.

*2: The light flashes to indicate a malfunction.

⚠ CAUTION**■ If a safety system warning light does not turn on**

Should a safety system light such as ABS/Multi Terrain ABS and the SRS warning light not turn on when you start the engine, this could mean that these systems are not available to help protect you in an accident, which could result in death or serious injury. Have the vehicle inspected by any authorized Toyota dealer or repairer, or another duly qualified and equipped professional immediately if this occurs.

2

When driving

امداد خودرو فارما

تلفن شبانه روزی: ۰۲۱-۸۸۸۶۲۰۸۵

FarmaSOS.com

2-2. Instrument cluster

Multi-information display (Non-Optitron type meters)*

The multi-information display presents the driver with a variety of driving-related data including the current outside air temperature.

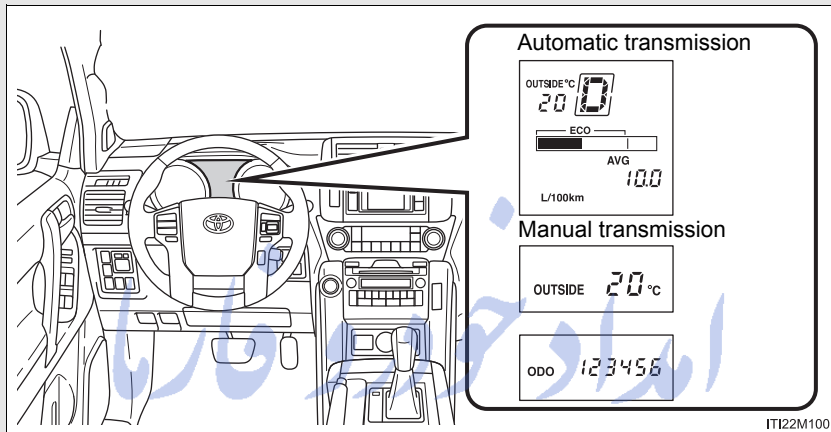

- Outside temperature display (→P. 582)
- Odometer/trip meter display (→P. 277)
- Trip information (→P. 277)

Displays driving range, fuel consumption and other cruising-related information.

- Shift position and shift range (if equipped) (→P. 249)
- Eco Driving Indicator Zone Display (if equipped) (→P. 280)

*: If equipped

Switching the display

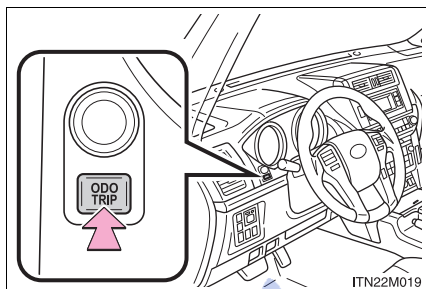

Items displayed can be switched by pressing the “ODO/TRIP” button.

Display items

■ Odometer

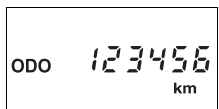

Displays the total distance the vehicle has been driven.

■ Trip meters A and B



Displays the distance the vehicle has been driven since the meter was last reset. Trip meters A and B can be used to record and display different distances independently.



Press the hold the button to reset.

■ Driving range

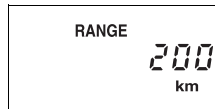

Displays the estimated maximum distance that can be driven with the quantity of fuel remaining

- This distance is computed based on your average fuel consumption. As a result, the actual distance that can be driven may differ from that displayed.
- When only a small amount of fuel is added to the tank, the display may not be updated.

■ Current fuel consumption

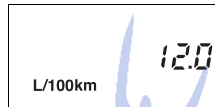

Displays the current rate of fuel consumption

■ Eco Driving Indicator Zone Display* (→P. 280) and average fuel consumption

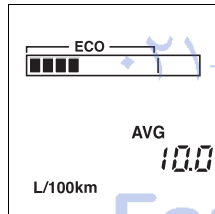

Displays the average fuel consumption since the function was reset

- The function can be reset by pressing the "ODO/TRIP" button for longer than 1 second when the average fuel consumption is displayed.
- Use the displayed average fuel consumption as a reference.

■ Average vehicle speed

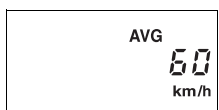

Displays the average vehicle speed since the engine was started or the function was reset

The function can be reset by pressing the “ODO/TRIP” button for longer than 1 second when the average vehicle speed is displayed.

■ Eco Driving Indicator Light setting screen*

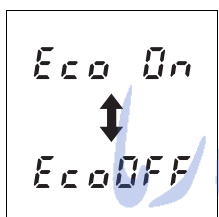

Eco Driving Indicator Light can be set to on or off.

The function can be activated or deactivated by pressing the “ODO/TRIP” button for longer than 1 second when Eco Driving Indicator Light setting screen is displayed.

2

When driving

*: Displayed on vehicles with an automatic transmission only

تلفن شبانه روزی: ۰۲۱-۸۸۶۲۰۸۵

FarmaSOS.com

■ Eco Driving Indicator

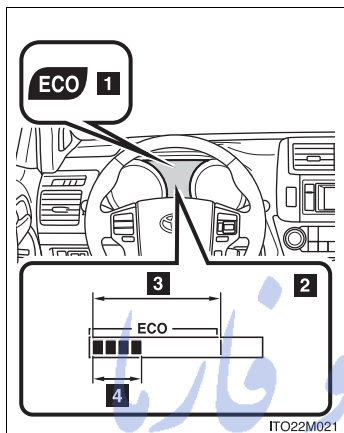

- 1** Eco Driving Indicator Light
During Eco-friendly acceleration (Eco driving), Eco Driving Indicator Light will turn on.
 - 2** Eco Driving Indicator Zone Display
Suggests Zone of Eco driving with current Eco driving ratio based on acceleration.
 - 3** Zone of Eco driving
 - 4** Eco driving ratio based on acceleration
- If the vehicle exceeds Zone of Eco driving, the right side of Eco Driving Indicator Zone Display will blink and Eco Driving Indicator Light will turn off.

Eco Driving Indicator Light will not operate in the following conditions:

- The shift lever is in anything other than D.
- The vehicle is set to second start mode. (→P. 252)
- The vehicle speed is approximately 130 km/h (81 mph) or higher.

■ When disconnecting and reconnecting battery terminals

The following information data will be reset:

- Trip meter
- Average fuel consumption
- Average vehicle speed

If the trip meter was displayed last, the ODO screen will be displayed after resetting.

CAUTION

■ The information display at low temperatures (vehicles with an automatic transmission)

Allow the interior of the vehicle to warm up before using the information display. At extremely low temperatures, the information display monitor may respond slowly, and display changes may be delayed.

For example, there is a lag between the driver's shifting and the new gear number appearing on the display. This lag could cause the driver to down-shift again, causing rapid and excessive engine braking and possibly an accident resulting in death or serious injury.

تلفن شبانه روزی:

NOTICE

■ The multi-information display at low temperatures

Allow the interior of the vehicle to warm up before using the information display. At extremely low temperatures, the information display monitor may respond slowly, and display changes may be delayed.

2

When driving

2-2. Instrument cluster

Multi-information display (Optitron type meters)*

The multi-information display presents the driver with a variety of driving-related data including the current outside air temperature.

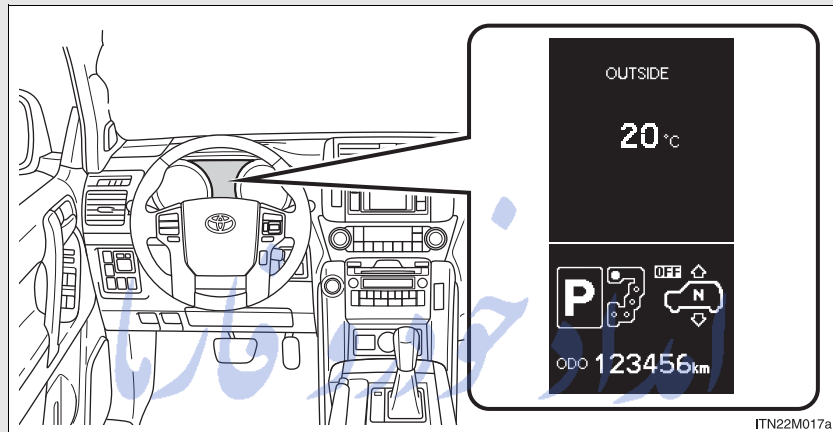

- Trip information contents (→P. 283)
Displays driving range, fuel consumption and other cruising-related information.
- Electronic features control contents (→P. 286)
- Other contents (→P. 287)

FarmaSOS.com

*: If equipped

Switching the display

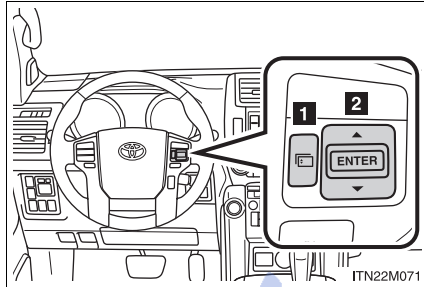

1 Menu switch

Changes modes to electronic features control mode, customization mode or back to normal display mode

2 "ENTER" switch

Changes trip information items. This switch is also used to turn on/off electronic features controls and to change customization settings.

2

When driving

Display items

■ Trip information contents

Trip information items displayed can be switched by pressing the "ENTER" switch upwards or downwards. تلفن شبانه روزی

● Front tire angle



The direction of the front tires is displayed

The tire direction is displayed in 3 stages for both left and right, in accordance with the angle of the tire.

● Driving range



Displays the estimated maximum distance that can be driven with the quantity of fuel remaining

- This distance is computed based on your average fuel consumption. As a result, the actual distance that can be driven may differ from that displayed.
- When only a small amount of fuel is added to the tank, the display may not be updated.

● Average fuel consumption after refueling



Displays the average fuel consumption since the vehicle was last refueled

Use the displayed average fuel consumption as a reference.

● Current fuel consumption تلفن شبانه روزی: ۰۸۵ + ۲۱۸۸۵۲

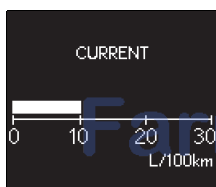

Displays the current rate of fuel consumption

- Average fuel consumption

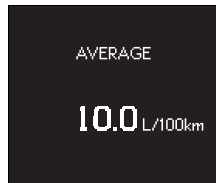

Displays the average fuel consumption since the function was reset

- The function can be reset by pressing the “ENTER” switch for longer than 1 second when the average fuel consumption is displayed.
- Use the displayed average fuel consumption as a reference.

- Average vehicle speed



Displays the average vehicle speed since the engine was started or the function was reset

The function can be reset by pressing the “ENTER” switch for longer than 1 second when the average vehicle speed is displayed.

- Elapsed time

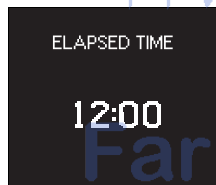

Displays the elapsed time since the function was last reset

The function can be reset by pressing the “ENTER” switch for longer than 1 second when the elapsed time is displayed.

2

When driving

2-2. Instrument cluster

- Outside temperature display

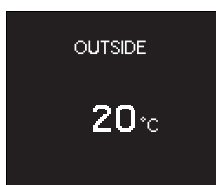

Displays the outside temperature

The temperature range that can be displayed is from -40 °C (-40 °F) to 50 °C (122 °F).

- Display off

A blank screen is displayed

- Eco Driving Indicator Zone Display

→P. 289

- **Electronic features control contents**

- Multi-terrain Select (if equipped)

→Refer to the “Off-road Driving Owner’s Manual”

- Toyota parking assist-sensor (if equipped) (→P. 345)

- AFS (Adaptive Front-lighting System) (if equipped) (→P. 307)

- Second start mode (if equipped) (→P. 252)

FarmaSOS.com

■ Other contents

- Shift position and shift range (if equipped) (→P. 249)
- Rear height control air suspension display (if equipped)
→Refer to the “Off-road Driving Owner’s Manual”
- Multi-terrain Select display (if equipped)
→Refer to the “Off-road Driving Owner’s Manual”
- Toyota parking assist-sensor display* (if equipped) (→P. 345)
- Crawl Control display* (if equipped)
→Refer to the “Off-road Driving Owner’s Manual”
- Dynamic radar cruise control display* (if equipped) (→P. 328)
- Warning messages (→P. 718)

Automatically displayed when a malfunction occurs in one of the vehicles systems

- Customization
تلفن شبانه روزی: ۰۸۵-۸۸۶۲-۸۸۸۱
Settings (e.g. available language) can be changed.
(Customizable features →P. 849)

*: Automatically displayed when the system is used

■ **Electronic features control can be turned on/off when**

“ENGINE START STOP” switch is in IGNITION ON mode.

■ **System check display**

After turning the “ENGINE START STOP” switch to IGNITION ON mode, “TOYOTA” is displayed while system operation is checked. When the system check is complete, the normal screen will return.

■ **Conditions for ending electronic features control**

In the following situations, the electronic features control will end automatically:

- The menu switch is pressed
- Toyota parking assist-sensor starts operating
- The Crawl Control is operated
- The dynamic radar cruise control is operated
- A warning message appears after the electronic features control screen is displayed

تلفن شبانه روزی: ۰۲۱-۸۸۶۲۰۸۵

FarmaSOS.com

■ Eco Driving Indicator

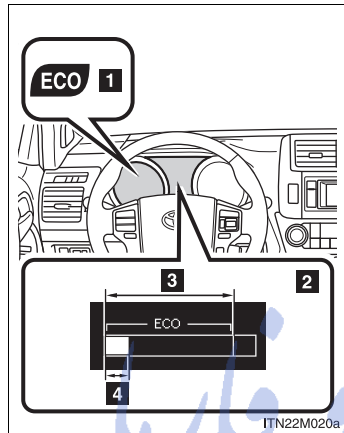

- 1** Eco Driving Indicator Light
During Eco-friendly acceleration (Eco driving), Eco Driving Indicator Light will turn on.
- 2** Eco Driving Indicator Zone Display
Suggests Zone of Eco driving with current Eco driving ratio based on acceleration.
- 3** Zone of Eco driving
- 4** Eco driving ratio based on acceleration
If the vehicle exceeds Zone of Eco driving, the right side of Eco Driving Indicator Zone Display will blink and Eco Driving Indicator Light will turn off.

Eco Driving Indicator Light will not operate in the following conditions:

- The shift lever is in anything other than D.
- The vehicle is set to second start mode. (→P. 252)
- The vehicle speed is approximately 130 km/h (81 mph) or higher.

2

When driving

■ **Outside temperature display**

In the following situations, the correct outside temperature may not be displayed, or the display may take longer than normal to change:

- When the vehicle is stopped, or moving at low speeds (less than 20 km/h [12 mph])
- When the outside temperature has changed suddenly (at the entrance/exit of a garage, tunnel, etc.)

■ **When “-” or “E” is displayed**

The system may be malfunctioning. Take your vehicle to any authorized Toyota dealer or repairer, or another duly qualified and equipped professional.

■ **When disconnecting and reconnecting battery terminals**

The following information data will be reset:

- Average fuel consumption after refueling
- Average fuel consumption
- Average vehicle speed
- Elapsed time

تلفن شبانه روزی: ۰۲۱-۸۸۶۲۰۸۵

FarmaSOS.com

⚠ CAUTION**■ The information display at low temperatures (vehicles with an automatic transmission)**

Allow the interior of the vehicle to warm up before using the information display. At extremely low temperatures, the information display monitor may respond slowly, and display changes may be delayed.

For example, there is a lag between the driver's shifting and the new gear number appearing on the display. This lag could cause the driver to down-shift again, causing rapid and excessive engine braking and possibly an accident resulting in death or serious injury.

⚠ NOTICE**■ The multi-information display at low temperatures**

Allow the interior of the vehicle to warm up before using the information display. At extremely low temperatures, the information display monitor may respond slowly, and display changes may be delayed.

2

When driving

امداد خودرو فارما
تلفن شبانه روزی: ۰۲۱-۸۸۶۲۰۸۵
FarmaSOS.com

2-2. Instrument cluster

Multi-information display (Accessory meters)*

The multi-information display presents the driver with a variety of driving-related data including the current outside air temperature.

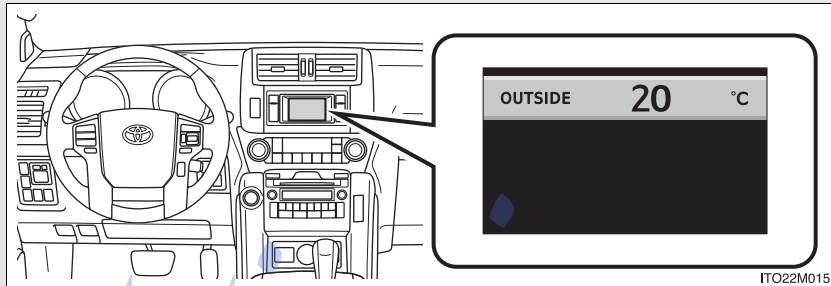

- Outside temperature display (→P. 293)
- Rear view monitor (if equipped) (→P. 356)
Automatically displayed when the shift lever is moved into R.
- Multi-terrain Monitor (if equipped)
→Refer to the “Off-road Driving Owner’s Manual”
- Wide view front & side monitor (if equipped) (→P. 361)
- Trip information (→P. 293)
Displays driving range, fuel consumption and other cruising-related information.
- Toyota parking assist-sensor (if equipped) (→P. 345)

*: If equipped

Switching the display

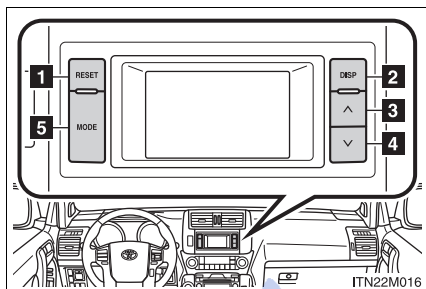

Items displayed can be switched by pressing the “MODE” switch.

- 1 “RESET” switch
- 2 “DISP” switch
- 3 “^” switch
- 4 “v” switch
- 5 “MODE” switch

Display items

■ Outside temperature display

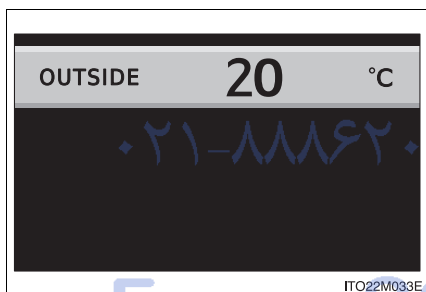

Displays the outside temperature

The temperature range that can be displayed is from -40 °C (-40 °F) to 50 °C (122 °F).

2

When driving

FarmasOS.com

■ **Driving range**

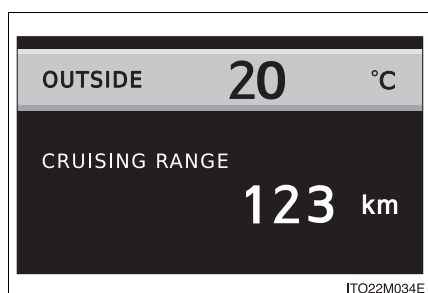

Displays the estimated maximum distance that can be driven with the quantity of fuel remaining

This distance is computed based on your average fuel consumption. As a result, the actual distance that can be driven may differ from that displayed.

When only a small amount of fuel is added to the tank, the display may not be updated.

■ **Average fuel consumption after refueling and current fuel consumption**

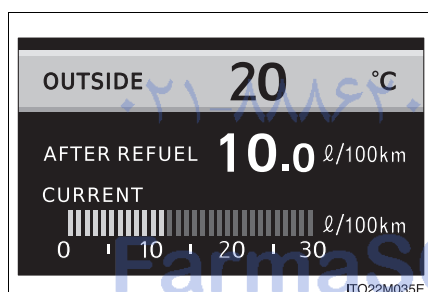

Displays the average fuel consumption since the vehicle was last refueled and the current rate of fuel consumption

Use the displayed average fuel consumption as a reference.

■ Average fuel consumption

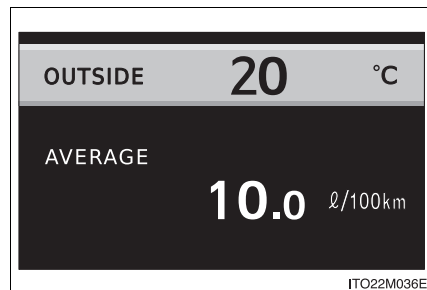

Displays the average fuel consumption since the function was reset

- The function can be reset by pressing and holding the "RESET" switch when the average fuel consumption is displayed.
- Use the displayed average fuel consumption as a reference.

■ Average vehicle speed

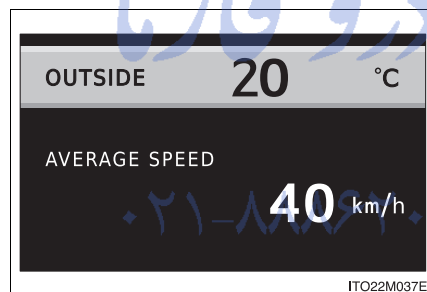

Displays the average vehicle speed since the function was reset

The function can be reset by pressing and holding the "RESET" switch when the average vehicle speed is displayed.

■ Elapsed time



Displays the elapsed time since the function was last reset

The function can be reset by pressing and holding the "RESET" switch when the elapsed time is displayed.

2

When driving

Setting up the display

■ Setting up the information display

To set up the display, press the “DISP” switch until the desired item appears.

If left idle for approximately 10 seconds, the display will revert to the previous screen.

● Setting the contrast

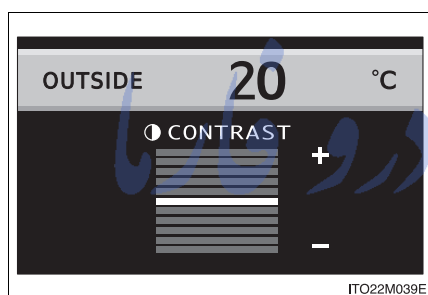

Press the “^” or “v” switch to adjust the contrast.

- + : Strengthen
- : Weaken

● Setting the brightness

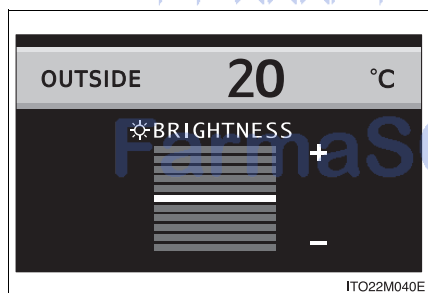

Press the “^” or “v” switch to adjust the brightness.

- + : Brighter
- : Darker

- Setting the day mode

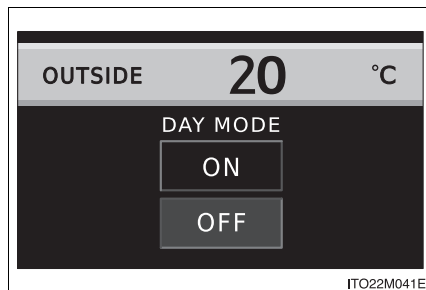

Press the “^” or “v” switch to select ON or OFF.

- Setting up the display of the monitors

To set up the display, press the “DISP” switch when the camera image is being displayed until the desired item appears.

If left idle for approximately 10 seconds, the display will revert to the previous screen.

- Setting the contrast

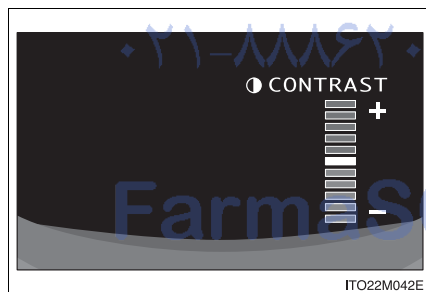

Press the “^” or “v” switch to adjust the contrast.

+: Strengthen

-: Weaken

2

When driving

- Setting the brightness

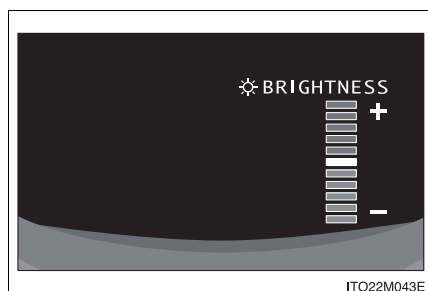

Press the “^” or “v” switch to adjust the brightness.

+: Brighter

-: Darker

- **Liquid crystal display**

Small spots or light spots may appear on the display. This phenomenon is characteristic of liquid crystal displays, and there is no problem continuing to use the display.

- **Outside temperature display**

In the following situations, the correct outside temperature may not be displayed, or the display may take longer than normal to change.

- When stopped, or driving at low speeds (less than 20 km/h [12 mph])
- When the outside temperature has changed suddenly (at the entrance/exit of a garage, tunnel, etc.)

FarmaSOS.com

■ **When “-” or “E” is displayed on the outside temperature display**

The system may be malfunctioning. Take your vehicle to any authorized Toyota dealer or repairer, or another duly qualified and equipped professional.

■ **When disconnecting and reconnecting battery terminals**

The following information data and settings will be reset:

- Average fuel consumption after refueling
- Average fuel consumption
- Average vehicle speed
- Elapsed time

■ **Customization**

Setting of available languages can be changed.
(Customizable features →P. 849)



NOTICE

■ **The multi-information display at low temperatures**

Allow the interior of the vehicle to warm up before using the liquid crystal information display. At extremely low temperatures, the information display monitor may respond slowly, and display changes may be delayed.

2-3. Operating the lights and wipers Headlight switch

The headlights can be operated manually or automatically.

Turning the end of the lever turns on the lights as follows:

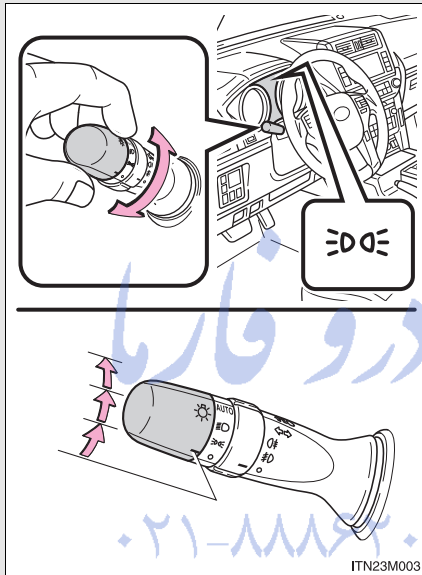

 The front position, tail, license plate and instrument panel lights turn on.

 The headlights and all lights listed above turn on.

AUTO (if equipped) Vehicles without a smart entry & start system: The headlights, and so on turn on and off automatically (when the engine switch is in the "ON" position.)

Vehicles with a smart entry & start system: The headlights front position lights and so on turn on and off automatically (when the "ENGINE START STOP" switch is in IGNITION ON mode.)

Turning on the high beam headlights

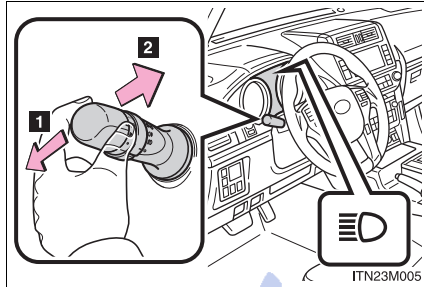

1 With the headlights on, push the lever away from you to turn on the high beams.

Pull the lever toward you to the center position to turn the high beams off.

2 Pull the lever toward you and release it to flash the high beams once.

You can flash the high beams with the headlights on or off.

Manual headlight leveling dial (if equipped)

The level of the headlights can be adjusted according to the number of passengers and the loading condition of the vehicle.

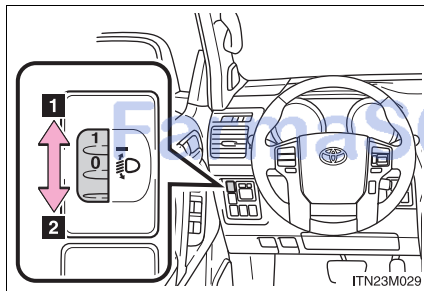

1 Raises the level of the headlights

2 Lowers the level of the headlights

■ **Guide to dial settings**

Vehicle category M1* without electronically modulated air suspension

Occupancy and luggage load conditions		Dial position	
Occupants	Luggage load	9-seat models	5-door, 7-seat models
Driver only, or driver and one passenger in the front seat	None	0	0
Driver, front passenger and all passengers in the rear seats farthest to the rear	None	1	1
All seats occupied	None	2.5	2
All seats occupied	Full luggage loading	3.5	2.5 ^{*1} 3 ^{*2} 3.5 ^{*3}
Driver	Full luggage loading	3.5	2.5 ^{*1} 3.5 ^{*2,3}

FarmaSOS.com

- *1: Vehicles with 18-inch tires with sub fuel tank of the following models:
KDJ150L-GKAEY, KDJ150L-GKFEY, GRJ150L-GKAEK
- *2: Vehicles with 18-inch tires of the following models:
GRJ150L-GKAEKW, KDJ150R-GKFEYW, KDJ150R-GKAEYW,
KDJ150L-GKFEYW, KDJ150L-GKAEYW, and
vehicles with 18-inch tires without sub fuel tank,
vehicles with 17-inch tires of the following models:
KDJ150L-GKAEY, KDJ150L-GKFEY, GRJ150L-GKAEK
- *3: Vehicles with 17-inch tires of the following models:
TRJ150L-GKPEK, TRJ150L-GKMEK, GRJ150L-GKAEKW,
KDJ150R-GKFEYW, KDJ150R-GKAEYW, KDJ150L-GKFEYW,
KDJ150L-GKAEYW

The model code is indicated on the manufacturer's label. (→P. 815)

2

When driving

تلفن شبانه روزی: ۰۲۱-۸۸۶۲۰۸۵

FarmaSOS.com

2-3. Operating the lights and wipers

Vehicle category M1* without electronically modulated air suspension

Occupancy and luggage load conditions		Dial position	
Occupants	Luggage load	5-door, 5-seat models	3-door, 5-seat models
Driver only, or driver and one passenger in the front seat	None	0	0
Driver, front passenger and all passengers in the rear seats farthest to the rear	None	1	1.5
All seats occupied	None	1	1.5
All seats occupied	Full luggage loading	3*4 3.5*5,7 4*6	3*8 3.5*9
Driver	Full luggage loading	3.5*4,7 4*5,6	3.5*8 4*9

FarmaSOS.com

- *4: Vehicles with 18-inch tires of the following models:
KDJ150L-GKAEY, KDJ150L-GKFEY, GRJ150L-GKAEK
 - *5: Vehicles with 17-inch tires of the following models:
TRJ150L-GKPEK, TRJ150L-GKMEK, KDJ150L-GKAEY,
KDJ150L-GKFEY, GRJ150L-GKAEK
 - *6: Vehicles with 17-inch tires of the following models:
GRJ150L-GKAEKW, KDJ150R-GKFEYW, KDJ150R-GKAEYW,
KDJ150L-GKFEYW, KDJ150L-GKAEYW
 - *7: Vehicles with 18-inch tires of the following models:
GRJ150L-GKAEKW, KDJ150R-GKFEYW, KDJ150R-GKAEYW,
KDJ150L-GKFEYW, KDJ150L-GKAEYW
 - *8: Vehicles with rain-sensing windshield wipers
 - *9: Vehicles with intermittent windshield wipers with interval adjuster
- The model code is indicated on the manufacturer's label. (→P. 815)

تلفن شبانه روزی: ۰۲۱-۸۸۶۲۰۸۵

FarmaSOS.com

2-3. Operating the lights and wipers

Vehicle category M1* with electronically modulated air suspension

Occupancy and luggage load conditions		Dial position
Occupants	Luggage load	
Driver only, or driver and one passenger in the front seat	None	0
Driver, front passenger and all passengers in the rear seats farthest to the rear	None	0
All seats occupied	None	0
All seats occupied	Full luggage loading	0.5
Driver	Full luggage loading	0.5

Vehicle category N1*

Occupancy and luggage load conditions		Dial position
Occupants	Luggage load	
Driver only, or driver and one passenger in the front seat	None	0
Driver	Full luggage loading	3.5 ^{*8} 4 ^{*9}

*8: Vehicles with rain-sensing windshield wipers

*9: Vehicles with intermittent windshield wipers with interval adjuster

*: To distinguish the vehicle category, ask any authorized Toyota dealer or repairer, or another duly qualified and equipped professional.

AFS (Adaptive Front-lighting System) (if equipped)

AFS (Adaptive Front-lighting System) secures excellent visibility at intersections and on curves by automatically adjusting the direction of the light axis of the headlights according to vehicle speed and the degree of the tire's angle as controlled by steering input.

AFS operates at speeds of 10 km/h (6 mph) or higher.

■ **Deactivating AFS**

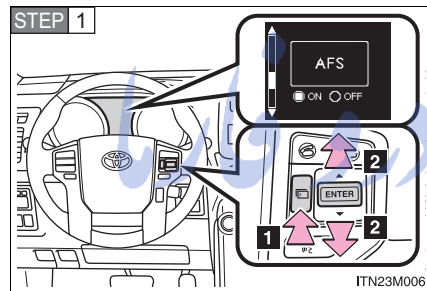

1 Press the menu switch.

The multi-information display will change modes to electronic features control mode.

2 Press the “ENTER” switch upwards or downwards until “AFS” appears.

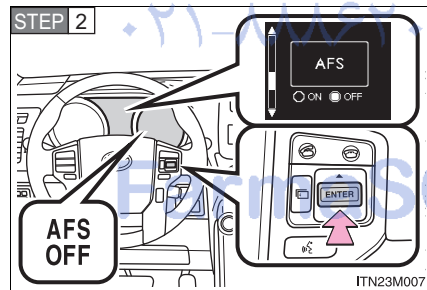

Press the “ENTER” switch to change to “OFF”.
The “AFS OFF” indicator will be displayed.

Each pressing of the switch turns “AFS” on and off.

Press the menu switch to change to the normal display.

2

When driving

■ **Daytime running light system (if equipped)**

To make your vehicle more visible to other drivers, the headlights and tail lights turn on automatically whenever the engine is started. Daytime running lights are not designed for use at night.

■ **Headlight control sensor (if equipped)**

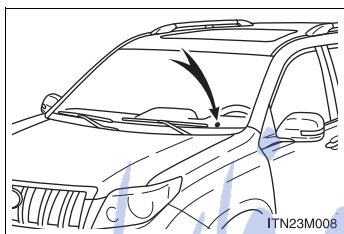

The sensor may not function properly if an object is placed on the sensor, or anything that blocks the sensor is affixed to the windshield.



Doing so interferes with the sensor detecting the level of ambient light and may cause the automatic headlight system to malfunction.

■ **Automatic light off system**

Type A

Vehicles without a smart entry & start system

The headlights, front position, tail, license plate, front and rear fog (if equipped), and instrument panel lights turn off automatically if the engine switch is turned to the “ACC” or “LOCK” position and the driver’s door is opened.



To turn the lights on again, turn the engine switch to the “ON” position, or turn the light switch off once and then back to  or .

Vehicles with a smart entry & start system

The headlights, front position, tail, license plate, front and rear fog (if equipped), and instrument panel lights turn off if the “ENGINE START STOP” switch is turned to ACCESSORY mode or turned off and the driver’s door is opened.

To turn the lights on again, turn the “ENGINE START STOP” switch to IGNITION ON mode, or turn the light switch off once and then back to  or

**Type B**

- When the light switch is in **auto**: The headlights, front position, tail, license plate, front and rear fog (if equipped), and instrument panel lights turn off automatically if the “ENGINE START STOP” switch is turned to ACCESSORY mode or turned off and a door or the glass hatch (if equipped) is opened and closed.
- When the light switch is in  or : The lights listed above except for tail lights turn off automatically if the “ENGINE START STOP” switch is turned to ACCESSORY mode or turned off. (A buzzer sounds if the driver’s door is opened at this time.)
تلفن شبانه روزی: ۰۲۱-۸۸۸۳۳۰۸۵

To turn the lights on again, turn the “ENGINE START STOP” switch to IGNITION ON mode, or turn the light switch off once and then back to  or



FarmaSOS.com



Type C

- When only the tail lights come on: The front position, tail, license plate, front and rear fog (if equipped), and instrument panel lights turn off if the “ENGINE START STOP” switch is turned to ACCESSORY mode or turned off the driver’s door is opened.
- When the headlights come on: The headlights, front position, tail, license plate, front and rear fog (if equipped), and instrument panel lights turn off 30 seconds after a door or the glass hatch (if equipped) is opened and closed.

To turn the lights on again, turn the “ENGINE START STOP” switch to IGNITION ON mode, or turn the light switch off once and then back to  or



Type D

- When the light switch is in auto : The headlights, front position, tail, license plate, front and rear fog (if equipped), and instrument panel lights turn off 30 seconds after a door or the glass hatch (if equipped) is opened and closed if the “ENGINE START STOP” switch is turned to ACCESSORY mode or turned off. (The lights turn off immediately if  on the key is pressed after all the doors are locked.)
- When the light switch is in  or  : The headlights and front fog lights turn off automatically if the “ENGINE START STOP” switch is turned to ACCESSORY mode or turned off. (A buzzer sounds if the driver’s door is opened at this time.)

To turn the lights on again, turn the “ENGINE START STOP” switch to IGNITION ON mode, or turn the light switch off once and then back to  or



■ **Automatic headlight leveling system (if equipped)**

The level of the headlights is automatically adjusted according to the number of passengers and the loading condition of the vehicle to ensure that the headlights do not interfere with other road users.

■ **If the “AFS OFF” indicator flashes**

It may indicate a malfunction in the system. Contact any authorized Toyota dealer or repairer, or another duly qualified and equipped professional.

■ **Light reminder buzzer (if equipped)**

A buzzer sounds when the “ENGINE START STOP” switch is turned off or turned to ACCESSORY mode and the driver’s door is opened while the tail lights remains on.

■ **Customization**

Settings (e.g. light sensor sensitivity) can be changed.
(Customizable features →P. 849)

2

When driving

 NOTICE

■ **To prevent battery discharge**

Do not leave the lights on longer than necessary when the engine is not running.

FarmaSOS.com

2-3. Operating the lights and wipers Fog light switch*

The fog lights secure excellent visibility in difficult driving conditions, such as in rain and fog.

Front and rear fog light switch

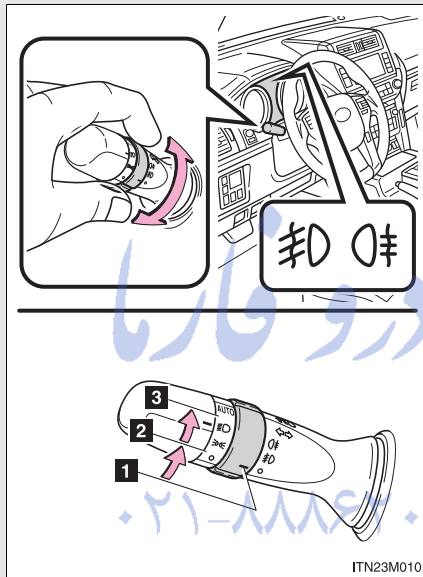

- 1 Turns the front and rear fog lights off
- 2 Turns the front fog lights on
- 3 Turns both front and rear fog lights on

Releasing the switch ring returns it to **OFF**.

Operating the switch ring again turns only the rear fog lights off.

FarmaSOS.com

*: If equipped

Rear fog light switch

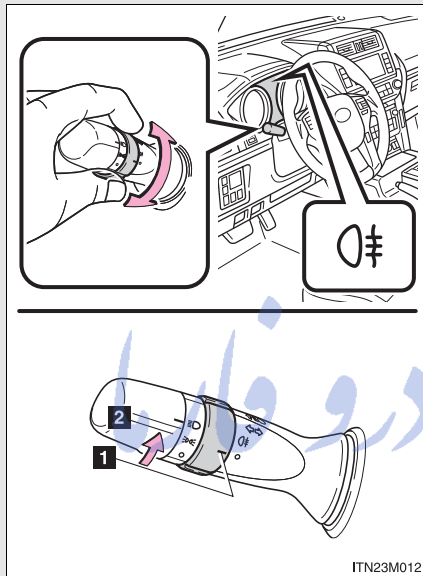

- 1 Turns the rear fog light off
- 2 Turns the rear fog light on

2

When driving

■ Fog lights can be used when

Vehicles with a front and rear fog light

Front fog lights: The headlights or front position lights are turned on.

Rear fog lights: The front fog lights are turned on.

Vehicles with a rear fog light only

The headlights or front position lights are turned on.

2-3. Operating the lights and wipers Windshield wipers and washer

Intermittent windshield wipers with interval adjuster

The wiper operation is selected by moving the lever as follows. When intermittent windshield wiper operation is selected, the wiper interval can be also adjusted.

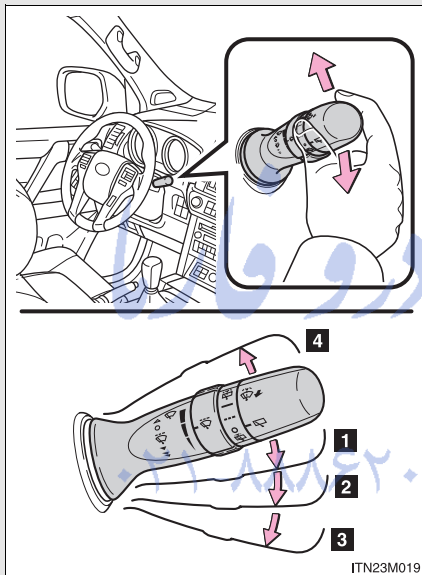

- 1 Intermittent windshield wiper operation
- 2 Low speed windshield wiper operation
- 3 High speed windshield wiper operation
- 4 Temporary operation

FarmaSOS.com

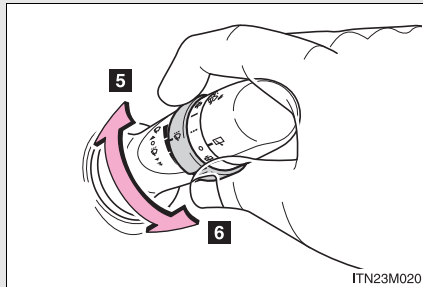

5 Increases the intermittent windshield wiper frequency

6 Decreases the intermittent windshield wiper frequency

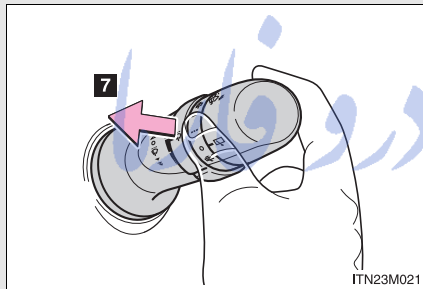

7 Washer/wiper dual operation

The wipers will automatically operate a couple of times after the washer squirts.

Vehicles with the headlight cleaners: If the headlights are on, the headlight cleaners will operate once.

2

When driving

FarmaSOS.com

تلفن شبانه روزی: ۰۲۱-۸۸۶۲۰۸۵

Rain-sensing windshield wipers (if equipped)

When **AUTO** is selected, the wipers will operate automatically when the sensor detects falling rain. The system automatically adjusts wiper timing in accordance with rain volume and vehicle speed.

When **AUTO** is selected, the sensor sensitivity can be adjusted as follows by turning the switch ring:

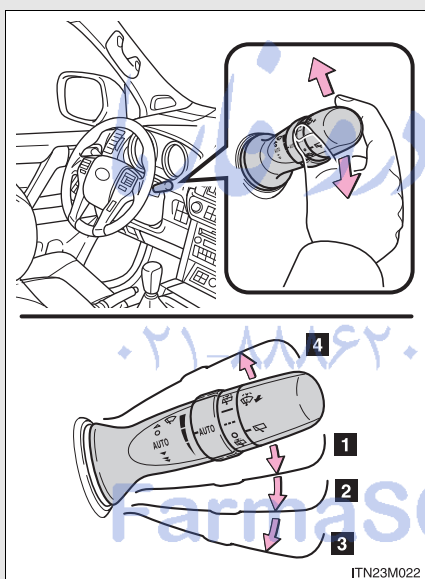

- 1 Rain-sensing wiper operation ("AUTO")
- 2 Low speed wiper operation
- 3 High speed wiper operation
- 4 Temporary operation

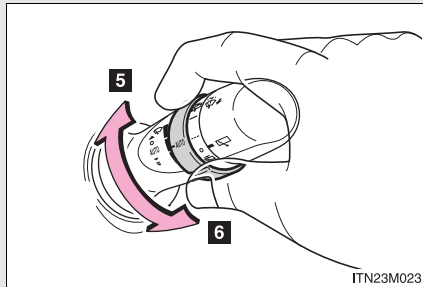

- 5** Increases the sensitivity
- 6** Decreases the sensitivity

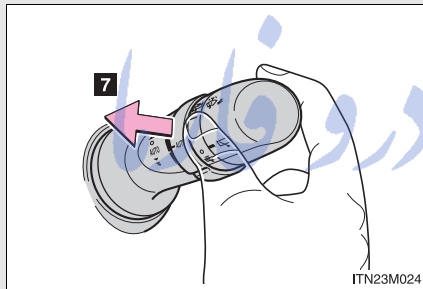

- 7** Washer/wiper dual operation

The wipers operate automatically. (After operating several times, the wipers operate one more time after a short delay to prevent dripping.)

Vehicles with the headlight cleaners: If the headlights are on, the headlight cleaners will operate once.

2

When driving

FarmaSOS.com

■ **The windshield wiper and washer can be operated when**

Vehicles without a smart entry & start system: The engine switch is in the “ON” position.

Vehicles with a smart entry & start system: The “ENGINE START STOP” switch is in IGNITION ON mode.

■ **Raindrop sensor (vehicles with rain-sensing windshield wipers)**

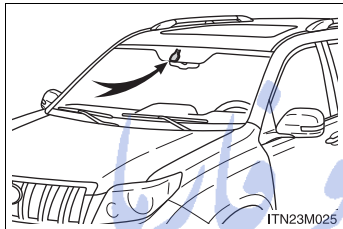

- The raindrop sensor judges the amount of raindrops.

An optical sensor is adopted. It may not operate properly when sunlight from the rising or setting of the sun intermittently strikes the windshield, or if bugs etc. are present on the windshield.

- If the wiper switch is turned to the “AUTO” position while the “ENGINE START STOP” switch is in IGNITION ON mode, the wipers will operate once to show that “AUTO” mode is activated.
- When the sensor sensitivity ring is turned toward high while in “AUTO” mode, the wipers will operate once to indicate that the sensor sensitivity is enhanced.
- If the temperature of the raindrop sensor is 90 °C (194 °F) or higher, or -15 °C (5 °F) or lower, automatic operation may not occur. In this case, operate the wipers in any mode other than “AUTO”.

■ **Effects of vehicle speed on wiper operation (vehicles equipped with rain-sensing windshield wipers)**

With the settings other than “AUTO” also, the time until drip prevention wiper sweep occurs is changed depending on vehicle speed.

With “LO” selected, wiper operation will be switched from low speed to intermittent wiper operation only when the vehicle is stationary. (However, when the sensor sensitivity is adjusted to the highest level, the mode cannot be switched.)

■ **If no windshield washer fluid sprays**

Check that the washer nozzles are not blocked if there is washer fluid in the windshield washer fluid reservoir.

 **CAUTION**

■ **Caution regarding the use of windshield wipers in “AUTO” mode**

The windshield wipers may operate unexpectedly if the sensor is touched or the windshield is subject to vibration in “AUTO” mode. Take care that your fingers or anything else does not become caught in the windshield wipers.

 **NOTICE**

■ **When the windshield is dry**

Do not use the wipers, as they may damage the windshield.

■ **When the washer fluid tank is empty**

Do not operate the switch continually as the washer fluid pump may over-heat.

■ **When there is no washer fluid spray from the nozzle**

Damage to the washer fluid pump may be caused if the lever is pulled toward you and held continually.

■ **When a nozzle becomes blocked**

Do not try to clear it with a pin or other object. The nozzle will be damaged.

2-3. Operating the lights and wipers Rear window wiper and washer

The wiper operation is selected by moving the lever as follows:

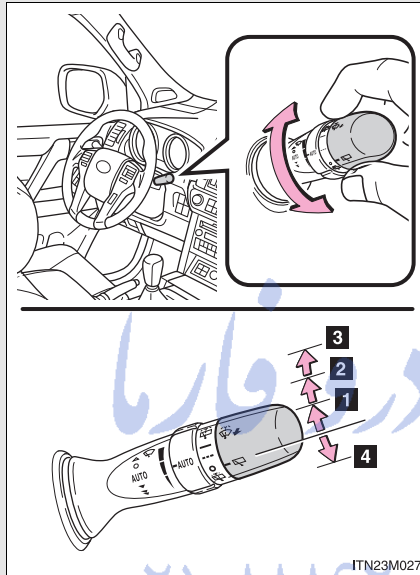

- 1 Intermittent window wiper operation
- 2 Normal window wiper operation
- 3 Washer operation
- 4 Washer/wiper dual operation

امداد خود فارما
تلفن شبانه روزی: ۰۸۵ ۰۸۸۶۰۲۱

FarmaSOS.com

■ **The rear window wiper and washer can be operated when**

- Vehicles without a smart entry & start system: The engine switch is in the "ON" position.

Vehicles with a smart entry & start system: The "ENGINE START STOP" switch is in IGNITION ON mode.

- The glass hatch (if equipped) is closed.

■ **If no washer fluid sprays**

Check that the washer nozzles are not blocked if there is washer fluid in the washer fluid reservoir.

 NOTICE

■ **When the rear window is dry**

Do not use the wiper, as it may damage the rear window.

■ **When the washer fluid tank is empty**

Do not operate the switch continually as the washer fluid pump may over-heat.

2

When driving

FarmaSOS.com

2-3. Operating the lights and wipers Headlight cleaner switch*

Washer fluid can be sprayed on the headlights.

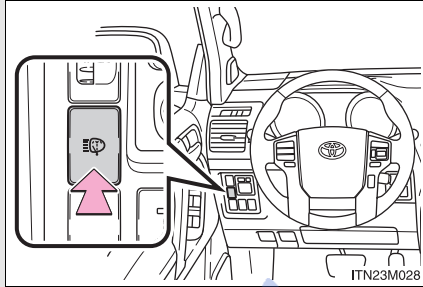

Press the switch to clean the headlights.

■ The headlight cleaners can be operated when

Vehicles without a smart entry & start system: The engine switch is in the "ON" position and the headlight switch is turned on.

If equipped, the headlight switch is in the "AUTO" position and the headlight is on.

Vehicles with a smart entry & start system: The "ENGINE START STOP" switch is in IGNITION ON mode and the headlight switch is turned on.

If equipped, the headlight switch is in the "AUTO" position and the headlight is on.

FarmaSOS.com

*: If equipped

■ **Windshield washer linked operation**

Vehicles without a smart entry & start system: When the windshield washer is operated with the engine switch is in the "ON" position and the headlight on, the headlight cleaners will operate once. (→P. 314)

Vehicles with a smart entry & start system: When the windshield washer is operated with the "ENGINE START STOP" switch is in IGNITION ON mode and the headlight on, the headlight cleaners will operate once. (→P. 314)

 NOTICE

■ **When the washer fluid tank is empty**

Do not press the switch continually as the washer fluid pump may overheat.

2

When driving

تلفن شبانه روزی: ۰۲۱-۸۸۶۲۰۸۵

FarmaSOS.com

2-4. Using other driving systems

Cruise control*

Use the cruise control to maintain a set speed without depressing the accelerator pedal.

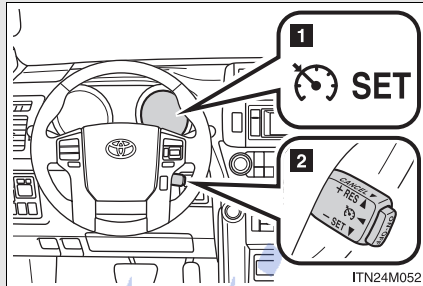

- 1 Indicators
- 2 Cruise control switch

■ Setting the vehicle speed

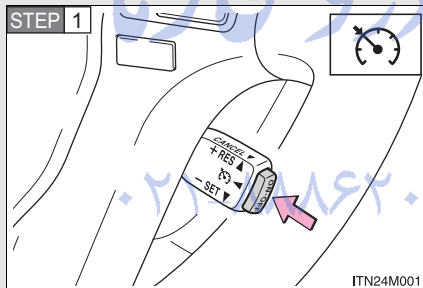

Press the “ON-OFF” button to activate the cruise control.

Cruise control indicator will come on.

Press the button again to deactivate the cruise control.

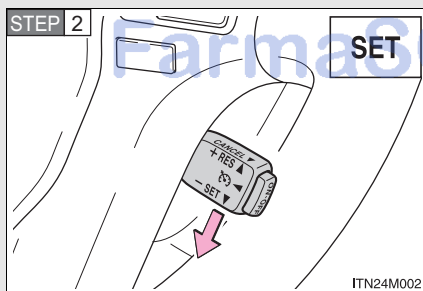

Accelerate or decelerate the vehicle to the desired speed, and push the lever down to set the speed.

“SET” indicator will come on.

The vehicle speed at the moment the lever is released becomes the set speed.

*: If equipped

■ **Adjusting the set speed**

To change the set speed, operate the lever until the desired set speed is obtained.

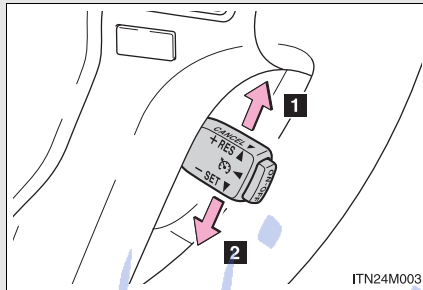

- 1 Increases the speed
- 2 Decreases the speed

Fine adjustment: Momentarily move the lever in the desired direction.

Large adjustment: Hold the lever in the desired direction.

The set speed will be increased or decreased as follows:

Fine adjustment: By approximately 1.6 km/h (1 mph) each time the lever is operated.

Large adjustment: The set speed can be increased or decreased continually until the lever is released.

■ **Canceling and resuming the constant speed control**

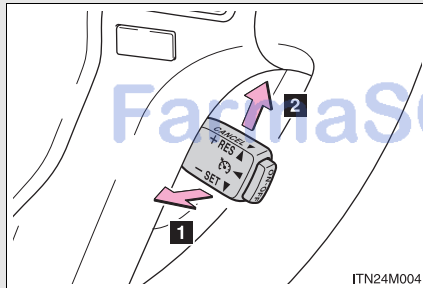

- 1 Pulling the lever toward you cancels the constant speed control.

The speed setting is also canceled when the brakes are applied or the clutch pedal (manual transmission only) is depressed.

- 2 Pushing the lever up resumes the constant speed control.

Resuming is available when the vehicle speed is more than approximately 40 km/h (25 mph).

2

When driving

■ **Cruise control can be set when**

- The shift lever is in the D or range 4 or higher of S has been selected (vehicles with an automatic transmission).
- Vehicle speed is above approximately 40 km/h (25 mph).

■ **Accelerating after setting the vehicle speed**

- The vehicle can be accelerated normally. After acceleration, the set speed resumes.
- Even without cancelling the cruise control, the set speed can be increased by first accelerating the vehicle to the desired speed and then pushing the lever down to set the new speed.

■ **Automatic cruise control cancelation**

Cruise control will stop maintaining the vehicle speed in any of the following situations:

- Actual vehicle speed falls more than approximately 16 km/h (10 mph) below the preset vehicle speed.
At this time, the memorized set speed is not retained.
- Actual vehicle speed is below approximately 40 km/h (25 mph).
- VSC is activated.

■ **If the cruise control indicator light flashes**

Press the “ON-OFF” button once to deactivate the system, and then press the button again to reactivate the system.

If the cruise control speed cannot be set or if the cruise control cancels immediately after being activated, there may be a malfunction in the cruise control system. Have the vehicle inspected by any authorized Toyota dealer or repairer, or another duly qualified and equipped professional.

 CAUTION

■ **To avoid operating the cruise control by mistake**

Switch the cruise control off using the "ON-OFF" button when not in use.

■ **Situations unsuitable for cruise control**

Do not use cruise control in any of the following situations. Doing so may result in loss of control and could cause an accident resulting in death or serious injury.

- In heavy traffic
- On roads with sharp bends
- On winding roads
- On slippery roads, such as those covered with rain, ice or snow
- On steep hills
Vehicle speed may exceed the set speed when driving down a steep hill.
- When your vehicle is towing a trailer (with towing hitch) or during emergency towing

2

When driving

تلفن شبانه روزی: ۰۲۱-۸۸۶۲۰۸۵

FarmaSOS.com

2-4. Using other driving systems

Dynamic radar cruise control*

Dynamic radar cruise control supplements conventional cruise control with a vehicle-to-vehicle distance control. In vehicle-to-vehicle distance control mode, the vehicle automatically accelerates or decelerates in order to maintain a set following distance from vehicles ahead.

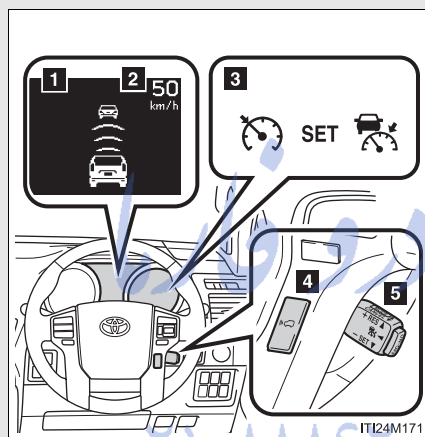

- 1 Display
- 2 Set speed
- 3 Indicators
- 4 Vehicle-to-vehicle distance button
- 5 Cruise control switch

FarmaSOS.com

*: If equipped

■ **Setting the vehicle speed (vehicle-to-vehicle distance control mode)**

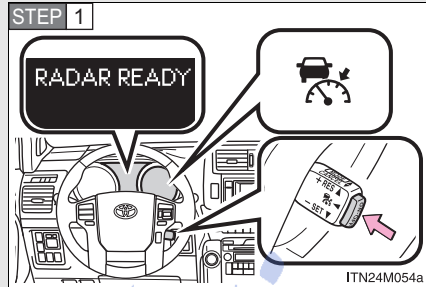

Press the “ON-OFF” button to activate the cruise control.

Dynamic radar cruise control indicator will come on.

Press the button again to deactivate the cruise control.

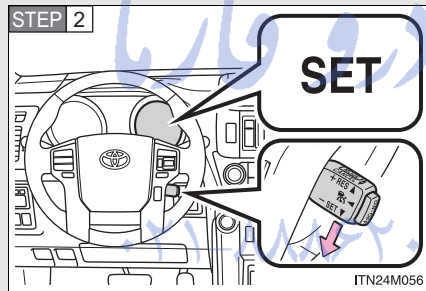

Accelerate or decelerate the vehicle to the desired speed, and push the lever down to set the speed.

“SET” indicator will come on.

The vehicle speed at the moment the lever is released becomes the set speed.

2

When driving

FarmaSOS.com

■ Adjusting the set speed

To change the set speed, operate the lever until the desired set speed is displayed.

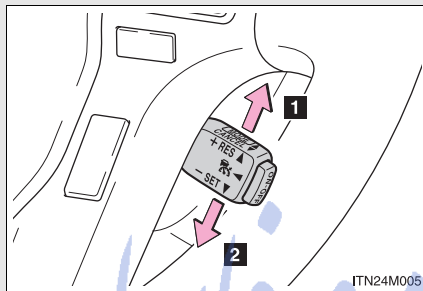

1 Increases the speed

2 Decreases the speed

Fine adjustment: Momentarily move the lever in the desired direction.

Large adjustment: Hold the lever in the desired direction.

In the vehicle-to-vehicle distance control mode, the set speed will be increased or decreased as follows:

- When the set speed is shown in “MPH”
Fine adjustment: By approximately 8 km/h (5 mph) each time the lever is operated
Large adjustment: By approximately 8 km/h (5 mph) for each 0.75 seconds the lever is held
- When the set speed is shown in “km/h”
Fine adjustment: By approximately 5 km/h (3.1 mph) each time the lever is operated
Large adjustment: By approximately 5 km/h (3.1 mph) for each 0.75 seconds the lever is held

In the constant speed control mode (→P. 335), the set speed will be increased or decreased as follows:

Fine adjustment: By approximately 1.6 km/h (1 mph) each time the lever is operated

Large adjustment: The set speed can be increased or decreased continually until the lever is released.

■ **Changing the vehicle-to-vehicle distance**

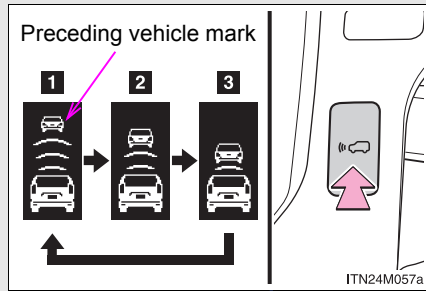

Pressing the button changes the vehicle-to-vehicle distance as follows:

- 1 Long
- 2 Medium
- 3 Short

The vehicle-to-vehicle distance is set automatically to long mode when the "ENGINE START STOP" switch is turned to IGNITION ON mode.

If a vehicle is running ahead of you, the preceding vehicle mark will be also displayed.

■ **Vehicle-to-vehicle distance settings**

Select a distance from the table below. Note that the distances shown correspond to a vehicle speed of 80 km/h (50 mph). Vehicle-to-vehicle distance increases/decreases in accordance with vehicle speed.

Distance options	Vehicle-to-vehicle distance
Long	Approximately 50 m (160 ft.)
Medium	Approximately 40 m (130 ft.)
Short	Approximately 30 m (100 ft.)

2

When driving

■ **Canceling and resuming the constant speed control**

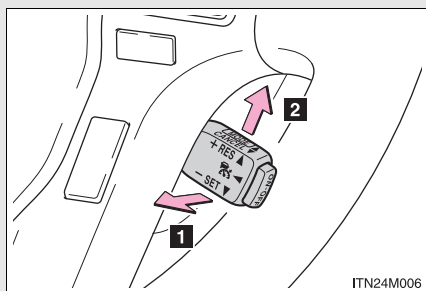

- 1** Pulling the lever toward you cancels the cruise control.

The speed setting is also canceled when the brakes are applied.

- 2** Pushing the lever up resumes the cruise control and returns vehicle speed to the set speed.

Resuming is available when the vehicle speed is more than approximately 40 km/h (25 mph).

تلفن شبانه روزی: ۰۲۱-۸۸۶۲۰۸۵

FarmaSOS.com

Driving in vehicle-to-vehicle distance control mode

This mode employs a radar sensor to detect the presence of vehicles up to approximately 120 m (400 ft.) ahead, determines the current vehicle-to-vehicle following distance, and operates to maintain a suitable following distance from the vehicle ahead.

Note that vehicle-to-vehicle distance will close in when traveling on long downhill slopes.

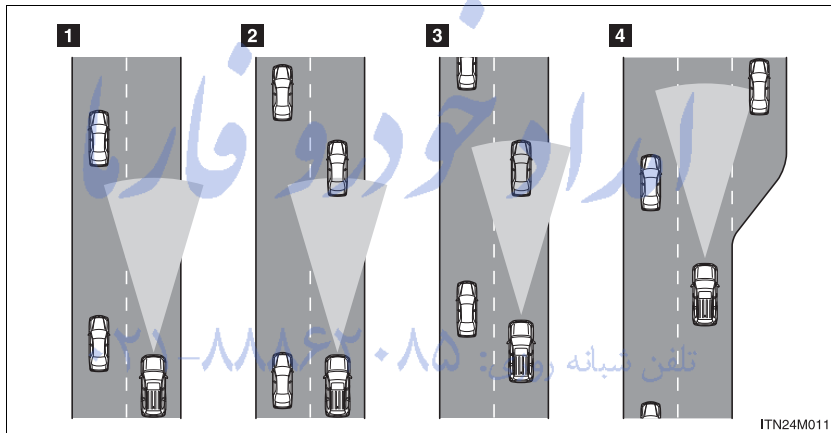

1 Example of constant speed cruising

When there are no vehicles ahead

The vehicle travels at the speed set by the driver. The desired vehicle-to-vehicle distance can also be set by operating the vehicle-to-vehicle distance control.

2 Example of deceleration cruising

When the vehicle ahead is driving slower than the set speed

When a vehicle is detected running ahead of you the system automatically decelerates your vehicle. When a greater reduction in vehicle speed is necessary, the system applies the brakes. A warning tone warns you when the system cannot decelerate sufficiently to prevent your vehicle from closing in on the vehicle ahead.

2

When driving

3 Example of follow-up cruising

When following a vehicle driving slower than the set speed

The system continues follow-up cruising while adjusting for changes in the speed of the vehicle ahead in order to maintain the vehicle-to-vehicle distance set by the driver.

4 Example of acceleration

When there are no longer any vehicles ahead driving slower than the set speed

The system accelerates until the set speed is reached. The system then returns to constant speed cruising.

Approach warning

When your vehicle is too close to a vehicle ahead, and sufficient automatic deceleration via the cruise control is not possible, the display will flash and the buzzer will sound to alert the driver. An example of this would be if another driver cuts in front of you while you are following a vehicle. Apply the brakes to ensure an appropriate vehicle-to-vehicle distance.

■ Warnings may not occur when

In the following instances, there is a possibility that the warnings will not occur:

- When the speed of the vehicle ahead matches or exceeds your vehicle speed
- When the vehicle ahead is traveling at an extremely slow speed
- Immediately after the cruise control speed was set
- At the instant the accelerator is applied

Selecting conventional constant speed control mode

Constant speed control mode differs from vehicle-to-vehicle distance control mode. When constant speed control mode is selected, your vehicle will maintain a set speed regardless of whether or not there are other vehicles in the lane ahead.

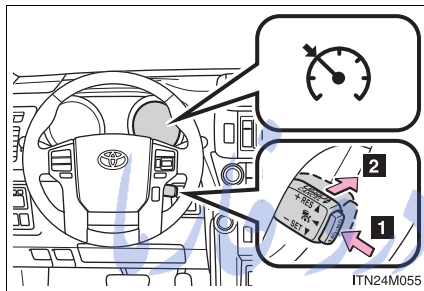

- 1 Press the “ON-OFF” button to activate the cruise control.

Press the button again to deactivate the cruise control.

- 2 Switch to constant speed control mode.

(Push the lever forward and hold for approximately 1 second.)

Constant speed control mode indicator will come on.

When in constant speed control mode, to return to vehicle-to-vehicle distance control mode, push the lever forward again and hold for approximately 1 second.

After the desired speed has been set, it is not possible to return to vehicle-to-vehicle distance control mode.

2

When driving

If the “ENGINE START STOP” switch is turned off and then turned to IGNITION ON mode again, the vehicle will automatically return to vehicle-to-vehicle distance control mode.

Adjusting the speed setting:
→P. 325

Canceling and resuming the speed setting: →P. 332

■ **Dynamic radar cruise control can be set when**

- The shift lever is in the D or range 4 or higher of S has been selected.
- Vehicle speed is above approximately 50 km/h (30 mph).

■ **Switching modes**

The mode cannot be switched to constant speed control mode if vehicle-to-vehicle distance control mode has been used. The mode also cannot be switched from constant speed control to vehicle-to-vehicle distance control mode. Turn the system off by pressing the “ON-OFF” button, and turn it on again.

■ **Accelerating after setting the vehicle speed**

The vehicle can be accelerated normally. After acceleration, the set speed resumes. However, during vehicle-to-vehicle distance control mode, the vehicle speed may decrease below the set speed in order to maintain the distance to the vehicle ahead.

■ Automatic cancelation of vehicle-to-vehicle distance control

Vehicle-to-vehicle distance control driving is automatically canceled in the following situations:

- Actual vehicle speed falls below approximately 40 km/h (25 mph).
- VSC is activated.
- The sensor cannot operate correctly because it is covered in some way.
- The windshield wipers are operating at high speed.
- When second start mode is set.
- Bad weather causes the detection function to become extremely unstable.

If vehicle-to-vehicle distance control driving is automatically canceled for any other reason, there may be a malfunction in the system. Contact any authorized Toyota dealer or repairer, or another duly qualified and equipped professional and have your Toyota inspected.

■ Automatic cancelation of constant speed control

The cruise control will stop maintaining the vehicle speed in the following situations:

- Actual vehicle speed is more than approximately 16 km/h (10 mph) below the set vehicle speed.
At this time, the memorized set speed is not retained.
- Actual vehicle speed falls below approximately 40 km/h (25 mph).
- VSC is activated.

2-4. Using other driving systems

■ Radar sensor and grille cover

Always keep the sensor and grille cover clean to ensure that the vehicle-to-vehicle distance control operates properly. (Some obstructions, such as snow, ice and plastic objects, cannot be detected by the obstruction sensor.) Dynamic radar cruise control is canceled if an obstruction is detected.

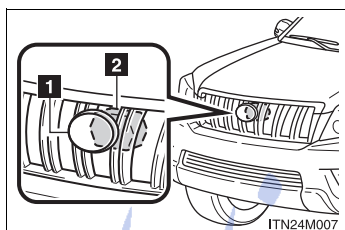

1 Grille cover

2 Radar sensor

■ Warning lights and messages for dynamic radar cruise control

Warning lights and messages are used to indicate a system malfunction or to inform the driver of the need for caution while driving. (→P. 718)

تلفن شبانه روزی: ۰۲۱-۸۸۶۲۰۸۵

FarmaSOS.com

■ Certification

<p>Hereby, DENSO CORPORATION declares that this DNMWR005 is in compliance with the essential requirements and other relevant provisions of Directive 1999/5/EC.</p>
<p>Hér með lýsir DENSO CORPORATION yfir því að DNMWR005 er í samræmi við grunnskýringu og aðrar kröfur, sem gerðar eru í tilskipun 1999/5/EC.</p>
<p>Con la presente DENSO CORPORATION dichiara che questo DNMWR005 è conforme ai requisiti essenziali ed alle altre disposizioni pertinenti stabilite dalla direttiva 1999/5/CE.</p>
<p>Käesolevaga kinnitab DENSO CORPORATION seadme DNMWR005 vastavust direktiivi 1999/5/EÜ põhinõuetele ja nimetatud direktiivist tulenevatele teistele asjakohastele sätetele.</p>
<p>Hierbij verklaart DENSO CORPORATION dat het toestel DNMWR005 in overeenstemming is met de essentiële eisen en de andere relevante bepalingen van richtlijn 1999/5/EG.</p>
<p>ΜΕ ΤΗΝ ΠΑΡΟΥΣΑ DENSO CORPORATION ΔΗΛΩΝΕΙ ΟΤΙ DNMWR005 ΣΥΜΜΟΡΦΩΝ ΕΤΑΙ ΠΡΟΣ ΤΙΣ ΟΥΣΙΩΔΕΙΣ ΑΠΑΙΤΗΣΕΙΣ ΚΑΙ ΤΙΣ ΛΟΙΠΕΣ ΣΧΕΤΙΚΕΣ ΔΙΑΤΑΞΕΙΣ ΤΗΣ ΟΔΗΓΙΑΣ 1999/5/ΕΚ.</p>
<p>Härmed intygar DENSO CORPORATION att denna DNMWR005 står i överensstämmelse med de väsentliga egenskapskrav och övriga relevanta bestämmelser som framgår av direktiv 1999/5/EG.</p>
<p>Por medio de la presente DENSO CORPORATION declara que el DNMWR005 cumple con los requisitos esenciales y cualesquiera otras disposiciones aplicables o exigibles de la Directiva 1999/5/CE.</p>
<p>DENSO CORPORATION tímto vyhlasuje, že DNMWR005 splňa základné požiadavky a všetky príslušné ustanovenia Smernice 1999/5/ES.</p>
<p>DENSO CORPORATION izjavlja, da je ta DNMWR005 v skladu z bistvenimi zahtevami in ostalimi relevantnimi določili direktive 1999/5/ES.</p>
<p>DENSO CORPORATION tímto prohlašuje, že tento DNMWR005 je ve shodě se základními požadavky a dalšími příslušnými ustanoveními směrnice 1999/5/ES.</p>

2

When driving

2-4. Using other driving systems

Undertegnede DENSO CORPORATION erklærer herved, at følgende udstyr DNMWR005 overholder de væsentlige krav og øvrige relevante krav i direktiv 1999/5/EF.
Hiermit erklært DENSO CORPORATION, dass sich das Gerät DNMWR005 in Übereinstimmung mit den grundlegenden Anforderungen und den übrigen einschlägigen Bestimmungen der Richtlinie 1999/5/EG befindet.
DENSO CORPORATION erklærer herved at utstyret DNMWR005 er i samsvar med de grunnleggende krav og øvrige relevante krav i direktiv 1999/5/EF.
Alulírott, DENSO CORPORATION nyilatkozom, hogy a DNMWR005 megfelel a vonatkozó alapvető követelményeknek és az 1999/5/EC irányelv egyéb előírásainak.
DENSO CORPORATION vakuuttaa täten että DNMWR005 tyyppinen laite on direktiivin 1999/5/EY oleellisten vaatimusten ja sitä koskevien direktiivin muiden ehtojen mukainen.
Par la présente DENSO CORPORATION déclare que l'appareil DNMWR005 est conforme aux exigences essentielles et aux autres dispositions pertinentes de la directive 1999/5/CE.
Niniejszym DENSO CORPORATION oświadcza, że DNMWR005 jest zgodny z zasadniczymi wymogami oraz pozostałymi stosownymi postanowieniami Dyrektywy 1999/5/EC.
DENSO CORPORATION declara que este DNMWR005 está conforme com os requisitos essenciais e outras disposições da Directiva 1999/5/CE.
Hawnhekk, DENSO CORPORATION, jiddikjara li dan DNMWR005 jikkonforma mal-htigijiet essenzjali u ma provvedimenti oħrajn relevanti li hemm fid-Dirrettiva 1999/5/EC.
Ar šo, DENSO CORPORATION, deklarē, ka DNMWR005 atbilst Direktīvas 1999/5/EK būtiskajām prasībām un citiem ar to saistītajiem noteikumiem.
Šiuo DENSO CORPORATION deklaruoja, kad šis DNMWR005 atitinka esminius reikalavimus ir kitas 1999/5/EB Direktyvos nuostatas.

⚠ CAUTION**■ Before using dynamic radar cruise control**

Do not overly rely on vehicle-to-vehicle distance control. Be aware of the set speed. If automatic deceleration/acceleration is not appropriate, adjust the vehicle speed, as well as the distance between your vehicle and vehicles ahead by applying the brakes etc.

■ Cautions regarding the driving assist systems

Observe the following precautions. Failure to do so may cause an accident resulting in death or serious injury.

- **Assisting the driver to measure following distance**
The dynamic radar cruise control is only intended to help the driver in determining the following distance between the driver's own vehicle and a designated vehicle traveling ahead. It is not a mechanism that allows careless or inattentive driving, and it is not a system that can assist the driver in low-visibility conditions. It is still necessary for driver to pay close attention to the vehicle's surroundings.
- **Assisting the driver to judge proper following distance**
The dynamic radar cruise control determines whether the following distance between the driver's own vehicle and a designated vehicle traveling ahead is appropriate or not. It is not capable of making any other type of judgement. Therefore, it is absolutely necessary for the driver to remain vigilant and to determine whether or not there is a possibility of danger in any given situation.
- **Assisting the driver to operate the vehicle**
The dynamic radar cruise control has no capability to prevent or avoid a collision with a vehicle traveling ahead. Therefore, if there is ever any danger, the driver must take immediate and direct control of the vehicle and act appropriately in order to ensure the safety of all involved.

2

When driving

 CAUTION

■ **To avoid inadvertent cruise control activation**

Switch the cruise control off using the “ON-OFF” button when not in use.

■ **Situations unsuitable for dynamic radar cruise control**

Do not use dynamic radar cruise control in any of the following situations.

Doing so may result in inappropriate speed control and could cause an accident resulting in death or serious injury.

- In heavy traffic
- On roads with sharp bends
- On winding roads
- On slippery roads, such as those covered with rain, ice and snow
- On steep downhills, or where there are sudden changes between sharp up and down gradients
Vehicle speed may exceed the set speed when driving down a steep hill.
- At entrances to expressways
- When weather conditions are bad enough that they may prevent the sensors from functioning correctly (fog, snow, sandstorm, heavy rain, etc.)
- When a buzzer is heard often
- When your vehicle is towing a trailer or during emergency towing
- In traffic conditions where the vehicle is repeatedly sped up and slowed down at frequent intervals

⚠ CAUTION**■ When the sensor may not be correctly detecting the vehicle ahead**

Apply the brakes as necessary when any of the following types of vehicles are in front of you.

As the sensor may not be able to correctly detect these types of vehicles, the approach warning (→P. 334) will not be activated, and a fatal or serious accident may result.

- Vehicles that cut in suddenly
- Vehicles traveling at low speeds
- Vehicles that are not moving
- Vehicles with small rear ends (trailers with no load on board etc.)
- Motorcycles traveling in the same lane

■ Conditions under which the vehicle-to-vehicle distance control may not function correctly

Apply the brakes as necessary in the following conditions as the radar sensor may not be able to correctly detect vehicles ahead, and a fatal or serious accident may result:

- When water or snow thrown up by the surrounding vehicles hinders the functioning of the sensor
- When your vehicle is pointing upwards (caused by a heavy load in the luggage compartment etc.)
- When the road curves or when the lanes are narrow
- When steering wheel operation or your position in the lane is unstable
- When the vehicle ahead of you decelerates suddenly
- Excessive exhaust gas (black smoke) is coming from the vehicle ahead or other vehicles around you, obscuring your front view
- The rear section of the vehicle ahead is extremely dirty
- The vehicle ahead has higher ground clearance

 CAUTION

■ **To ensure the sensor functions correctly**

Do not do the following to the sensor or grille as doing so may cause the sensor not to function correctly and could result in an accident:

- Sticking or attaching anything to them
- Leaving them dirty
- Disassembling or subjecting them to strong shocks
- Modifying or painting them
- Replacing them with non-genuine parts

■ **Handling the radar sensor**

Observe the following to ensure the cruise control system can function effectively.

Otherwise, the system may not function correctly and could result in an accident.

- Keep the sensor and front grille cover clean at all times.
Clean the sensor and front grille cover with a soft cloth so you do not mark or damage them.
- Do not subject the sensor or surrounding area to a strong impact.
If the sensor moves even slightly off position, the system may malfunction.
If the sensor or surrounding area is subject to a strong impact, always have the area inspected and adjusted by any authorized Toyota dealer or repairer, or another duly qualified and equipped professional.
- Do not disassemble the sensor.
- Do not attach accessories or stickers to the sensor, grille cover or surrounding area.
- Do not modify or paint the sensor and grille cover.
- Do not replace them with non-genuine parts.

2-4. Using other driving systems

Toyota parking assist-sensor*

The distance from your vehicle to nearby obstacles when parallel parking or maneuvering into a garage is measured by the sensors and communicated via the indicator (non-optitron type meters), the multi-information display (optitron type meters), the accessory meter (if equipped), and a buzzer. Always check the surrounding area when using this system.

Vehicles with a navigation system

Refer to the "Navigation System Owner's Manual".

Vehicles without a navigation system

■ Types of sensors

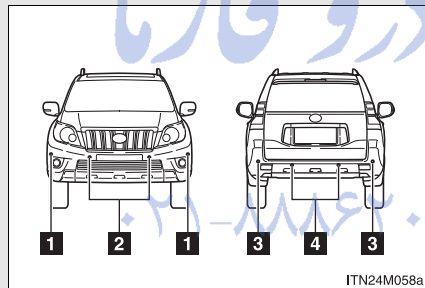

- 1 Front corner sensors (if equipped)
- 2 Front center sensors (if equipped)
- 3 Rear corner sensors
- 4 Rear center sensors

2

When driving

FarmaSOS.com

*: If equipped

■ Toyota parking assist-sensor switch

4 sensor type

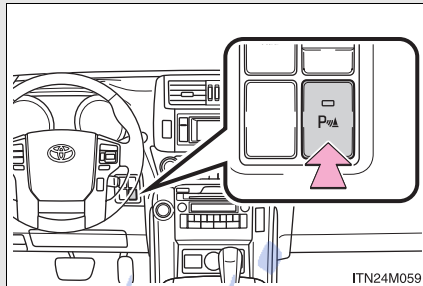

Turns Toyota parking assist-sensor on/off

When on, the indicator light come on and the buzzer sounds to inform the driver that the system is operational.

8 sensor type

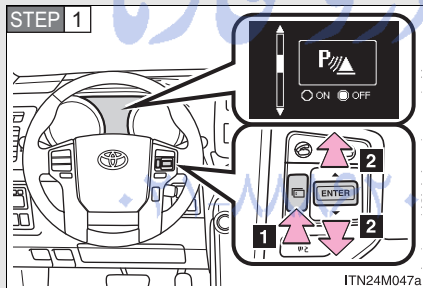

1 Press the menu switch.

The multi-information display will change modes to electronic features control mode.

2 Press the “ENTER” switch upwards or downwards until the Toyota parking assist-sensor mark appears in the multi-information display.

STEP 2

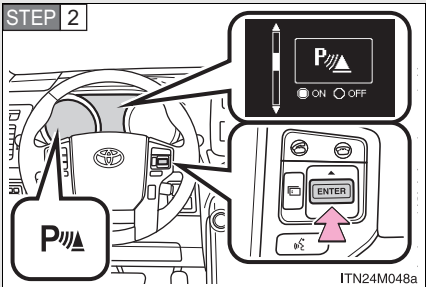

Press the “ENTER” switch to change to “ON”.
The Toyota parking assist-sensor indicator will be displayed.

Each pressing of the switch turns the Toyota parking assist-sensor on and off.

When on, the buzzer sounds to inform the driver that the system is operational.

Press the menu switch to change to the normal display.

2

When driving

Display

When the sensors detect an obstacle, the Toyota parking assist-sensor indicator is illuminated by an LED (non-optitron type meters), or a graphic is shown on the multi-information display (optitron type meters and accessory meters) depending on the position and distance to the obstacle.

■ 4 sensor type

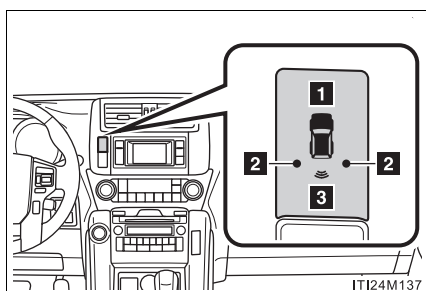

- 1 Vehicle indicator
- 2 Rear corner indicator
- 3 Rear center indicator

■ 8 sensor type (vehicles with an optitron type meter)

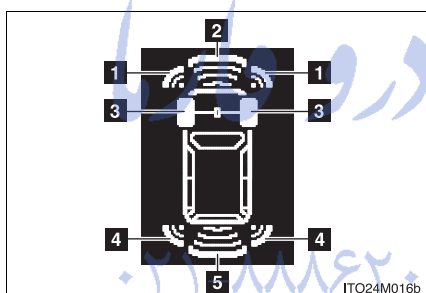

- 1 Front corner sensor operation
- 2 Front center sensor operation
- 3 Front tire angle
- 4 Rear corner sensor operation
- 5 Rear center sensor operation

■ 8 sensor type (vehicles with an accessory meter)

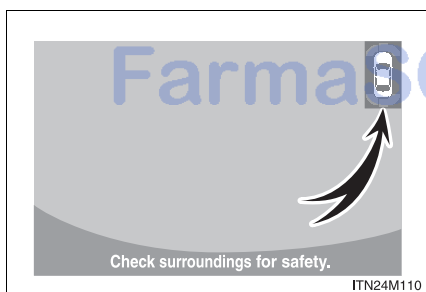

When the vehicle is moving forward or backward









A simplified image is displayed when an obstacle is detected.

The distance display and buzzer

When a sensor detects an obstacle, the direction of and the approximate distance to the obstacle are displayed and the buzzer sounds.

■ Distance display

Corner sensor













Approximate distance to obstacle*	4 sensor type	8 sensor type	
		Optitron type meter	Accessory meter (insert display)
Front: 60 cm (2.0 ft.) to 47.5 cm (1.6 ft.) Rear: 55 cm (1.8 ft.) to 37.5 cm (1.2 ft.)	 (blinking)	 (continuous)	 (blinking)
Front: 47.5 cm (1.6 ft.) to 35 cm (1.1 ft.) Rear: 37.5 cm (1.2 ft.) to 25 cm (0.8 ft.)	 (blinking rapidly)	 (continuous)	 (blinking rapidly)
Front: Less than 35 cm (1.1 ft.) Rear: Less than 25 cm (0.8 ft.)	 (continuous)	 (blinking)	 (continuous)

*: 4 sensor type contains only rear sensors

2

When driving

Center sensors

Approximate distance to obstacle *	4 sensor type	8 sensor type	
		Optitron type meter	Accessory meter (insert display)
Front: 100 cm (3.3 ft.) to 50 cm (1.6 ft.) Rear: 150 cm (4.9 ft.) to 65 cm (2.1 ft.)	 (blinking slowly)	 (continuous)	 (blinking slowly)
Front: 50 cm (1.6 ft.) to 37.5 cm (1.2 ft.) Rear: 65 cm (2.1 ft.) to 50 cm (1.6 ft.)	 (blinking)	 (continuous)	 (blinking)
Front: 37.5 cm (1.2 ft.) to 30 cm (1.0 ft.) Rear: 50 cm (1.6 ft.) to 40 cm (1.3 ft.)	 (blinking rapidly)	 (continuous)	 (blinking rapidly)
Front: Less than 30 cm (1.0 ft.) Rear: Less than 40 cm (1.3 ft.)	 (continuous)	 (blinking)	 (continuous)

*: 4 sensor type contains only rear sensors

■ **Buzzer operation and distance to an obstacle**

A beep sounds when the corner sensors and center sensors are operating.

- The buzzer beeps faster as the vehicle approaches an obstacle. When the vehicle comes within the following distance of the obstacle, the buzzer sounds continuously.
 - Front corner sensors: Approximately 35 cm (1.1 ft.)
 - Front center sensors: Approximately 30 cm (1.0 ft.)
 - Rear corner sensors: Approximately 25 cm (0.8 ft.)
 - Rear center sensors: Approximately 40 cm (1.3 ft.)
- When 2 or more obstacles are detected simultaneously, the buzzer system responds to the nearest obstacle.

■ **Sensors that operate**

4 sensor type

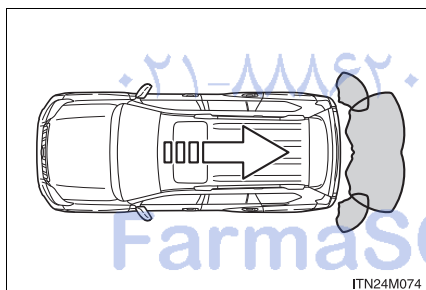

8 sensor type

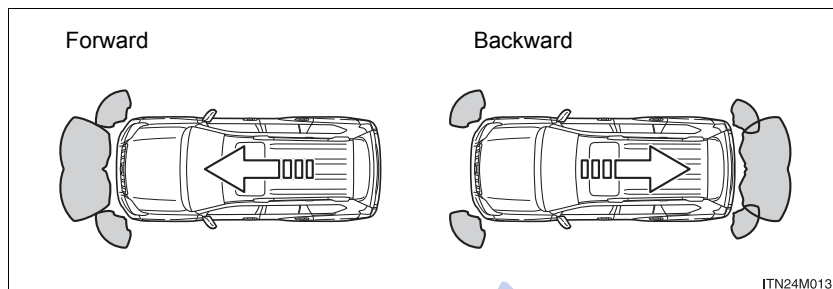

■ Detection range of the sensors

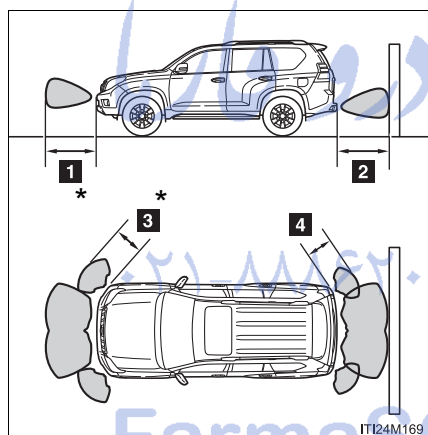

- 1 Approximately 100 cm (3.3 ft.)
- 2 Approximately 150 cm (4.9 ft.)
- 3 Approximately 60 cm (2.0 ft.)
- 4 Approximately 55 cm (1.8 ft.)

The diagram shows the detection range of the sensors. Note that the sensors may not be able to detect obstacles that are extremely close to the vehicle.

The range of the sensors may change depending on the shape of the object etc.

*: If equipped

■ Sensor detection information

- Certain vehicle conditions and the surrounding environment may affect the ability of a sensor to correctly detect an obstacle. Particular instances where this may occur are listed below.
 - There is dirt, snow or ice on a sensor.
 - A sensor is frozen.
 - A sensor is covered in any way.
 - The vehicle is leaning considerably to one side.
 - On an extremely bumpy road, on an incline, on gravel, or on grass.
 - The vicinity of the vehicle is noisy due to vehicle horns, motorcycle engines, air brakes of large vehicles, or other loud noises producing ultrasonic waves.
 - There is another vehicle equipped with parking assist sensors in the vicinity.
 - A sensor is coated with a sheet of spray or heavy rain.
 - The vehicle is equipped with a fender pole or radio antenna.
 - Towing eyelets are installed.
 - A bumper or sensor receives a strong impact.
 - The vehicle is approaching a tall or right-angled curb.
 - In harsh sunlight or intense cold weather.
 - A non-genuine Toyota suspension (lowered suspension etc.) is installed.

In addition to the examples above, there are instances in which, because of their shape, signs and other objects may be judged by a sensor to be closer than they are.

2-4. Using other driving systems

- The shape of the obstacle may prevent a sensor from detecting it. Pay particular attention to the following obstacles:
 - Wires, fences, ropes, etc.
 - Cotton, snow and other materials that absorb sound waves
 - Sharply-angled objects
 - Low obstacles
 - Tall obstacles with upper sections projecting outwards in the direction of your vehicle
- **If the vehicle indicator remains on while the rear corner and rear center indicators flash and the malfunction beep sounds for approximately 8 seconds. (vehicles with a non- optitron type meter)**

Have the vehicle inspected by any authorized Toyota dealer or repair, or another duly qualified and equipped professional.
- **If the vehicle indicator and the rear corner and rear center indicators flash and the malfunction beep sounds for approximately 8 seconds. (vehicles with a non- optitron type meter)**

Clean the sensors with soft cloth.
- **If a message is displayed (vehicles with an optitron type meter)**

→P. 718
- **Customization that can be configured at any authorized Toyota dealer or repair, or another duly qualified and equipped professional**

Setting of buzzer volume can be changed.
(Customizable features →P. 849)

 CAUTION

■ **Caution when using the Toyota parking assist-sensor**

Observe the following precautions.

Failing to do so may result in the vehicle being unable to be driven safely and possibly cause an accident.

- Do not use the sensor at speeds in excess of 10 km/h (6 mph).
- Do not attach any accessories within the sensor range.

 NOTICE

■ **Notes when washing the vehicle**

Do not apply intensive bursts of water or steam to the sensor area. Doing so may result in the sensor malfunctioning.

2

When driving

تلفن شبانه روزی: ۰۲۱-۸۸۶۲۰۸۵

FarmaSOS.com

2-4. Using other driving systems

Rear view monitor system (vehicles with an accessory meter)*

The rear view monitor assists the driver by displaying an image of the area behind the vehicle while reversing. The image is displayed in reverse on the screen. This reversed image is a similar image to the one on the inside rear view mirror.

Vehicles with a navigation system

For the advanced parking guidance system, refer to the “Navigation System Owner’s Manual”.

Vehicles without a navigation system

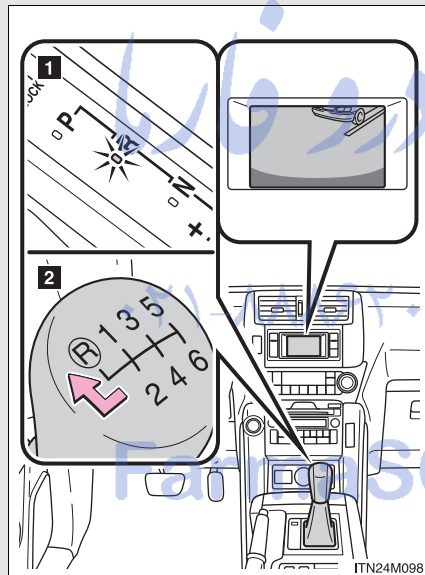

The rear view image is displayed when the shift lever is in the R position.

- 1 Vehicles with an automatic transmission
- 2 Vehicles with a manual transmission

If the shift lever is shifted out of R, the screen returns to the previous one.

*: If equipped

■ Displayed area

Vehicles with back door mounted spare tire

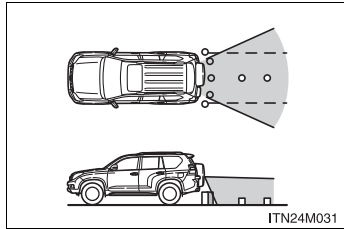

The area covered by the camera is limited. Objects which are close to either corner of the bumper or under the spare wheel cover cannot be seen on the screen.

The area displayed on the screen may vary depending on vehicle orientation or road conditions.

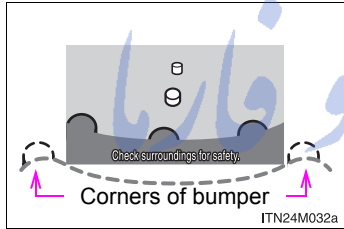

Vehicles without back door mounted spare tire

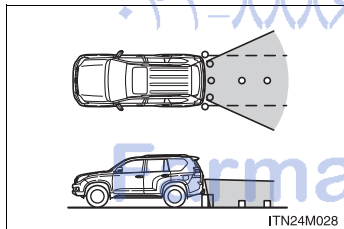

The area covered by the camera is limited. Objects which are close to either corner of the bumper or under the bumper cannot be seen on the screen.

The area displayed on the screen may vary depending on vehicle orientation or road conditions.

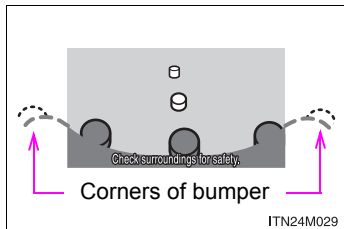

2

When driving

■ Rear view monitor camera

Vehicles with back door mounted spare tire

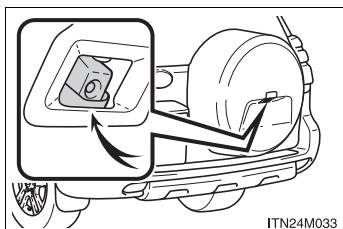

Vehicles without back door mounted spare tire

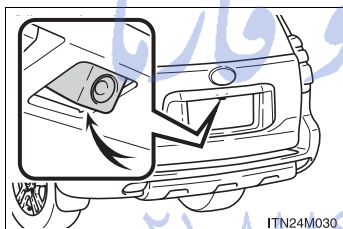

In the following cases, it may be difficult to see images on the screen even when the system is functioning correctly:

- The vehicle is in a dark area, such as at night.
- The temperature near the lens is extremely high or low.
- Water droplets are on the camera lens or humidity is high, such as when it rains.
- Foreign matter, such as snow and mud, adheres to the camera lens.
- The sun or headlights are shining directly into the camera lens.

■ When the back door is open

The screen cannot be used because a message is displayed.

When backing up the vehicle, make sure the back door is securely closed.

FarmaSOS.com

■ Smear effect

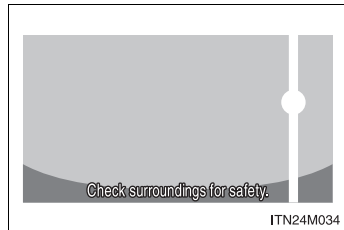

If a bright light, such as sunlight reflected off the vehicle body, is picked up by the camera, a smear effect* characteristic to the camera may occur.

*: Smear effect — A phenomenon that occurs when a bright light is picked up by the camera; when transmitted by the camera, the light source appears to have a vertical streak above and below it.

⚠ CAUTION

■ **When using the rear view monitor system**

Observe the following precautions to avoid an accident that could result in death or serious injuries:

- Never depend solely on the monitor system when reversing.
- Always check visually and with the mirrors to confirm your intended path is clear.
- Depicted distances between objects and flat surfaces differ from actual distances.

 CAUTION

■ **Conditions which may affect the rear view monitor system**

- If the back of the vehicle has been hit, the camera's position and mounting angle may have changed. Have the vehicle inspected by any authorized Toyota dealer or repairer, or another duly qualified and equipped professional.
- Rapid temperature changes, such as when hot water is poured on the vehicle in cold weather, may cause the system to function abnormally.
- If the camera lens is extremely dirty, it cannot transmit a clear image. Rinse with water and wipe with a soft cloth. If the camera lens is extremely dirty, wash with a mild cleanser and rinse.
- The displayed image may be darker and moving images may be slightly distorted when the system is cold.

تلفن شبانه روزی: ۰۲۱-۸۸۶۲۰۸۵

FarmaSOS.com

2-4. Using other driving systems

Wide view front & side monitor (vehicles with an accessory meter)*

This system can display the wide view front monitor and the side monitor.

The wide view front monitor uses a super-wide angle lens to display on screen the areas to the left and right of the vehicle and the blind spots to the front of the vehicle. This system helps the driver check for approaching cars, bicycles and pedestrians when at intersections with poor visibility.

The side monitor uses a camera installed in the passenger's side outside rear view mirror to display on screen the area to the right (left-hand drive vehicles) or left (right-hand drive vehicles) of the vehicle, helping the driver check this area.

Vehicles with a navigation system

Refer to the "Navigation System Owner's Manual".

Vehicles without a navigation system

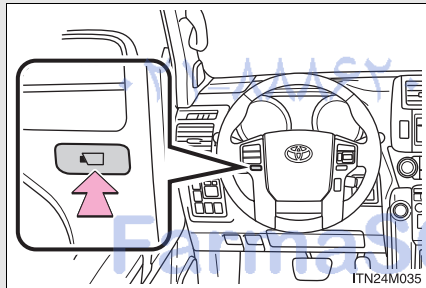

On/off

The camera image is displayed when the wide view front & side monitor switch is pressed.

*: If equipped

■ **Changing the display**

The screen changes as follows with each press of the wide view front & side monitor switch.

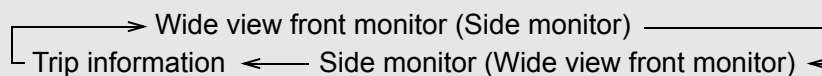

The wide view front monitor display and trip information are not accessible when the shift lever is in R.

On vehicles with Multi-terrain Select, the Multi-terrain Monitor can be switched to by pressing the wide view front & side monitor switch while the system is operating.

تلفن شبانه روزی: ۰۲۱-۸۸۶۲۰۸۵

FarmaSOS.com

Display

■ Wide view front monitor

The image from the front camera is displayed. Use this monitor to help check the area in front of the vehicle for safety, for example in intersections with poor visibility.

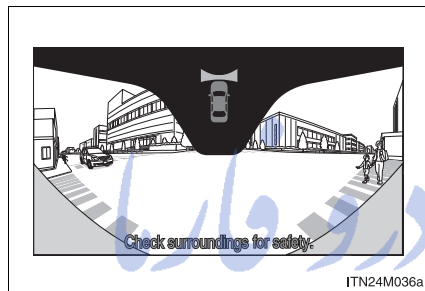

■ Side monitor

The image from the side camera is displayed. Use this monitor to help check the area to the right (left-hand drive vehicles) or left (right-hand drive vehicles) of the vehicle, for example when taking off and stopping, when turning right (left-hand drive vehicles) or left (right-hand drive vehicles), etc. (→P. 364)

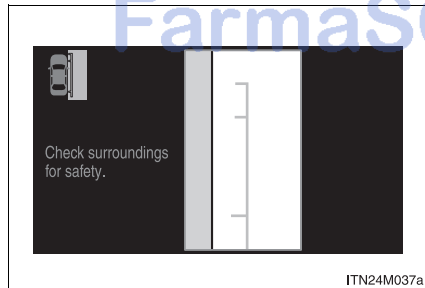

Using the side monitor

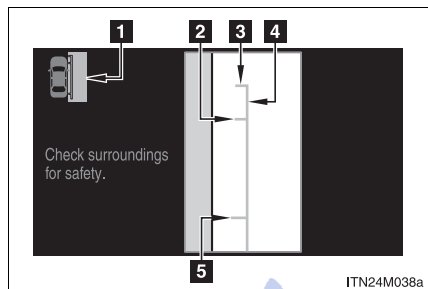

1 Vehicle icon

Displays the image being shown by the side monitor.

2 Front wheel contact point

Shows the position of the vehicle's front tire.

3 Vehicle front edge line

Shows the position of the vehicle's leading edge.

4 Vehicle width line

Indicates the width of the vehicle including the outside rear view mirror.

5 Rear wheel contact point

Shows the position of the vehicle's rear tire.

FarmaSOS.com

■ Using the vehicle width line

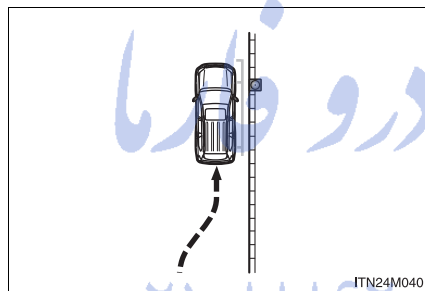
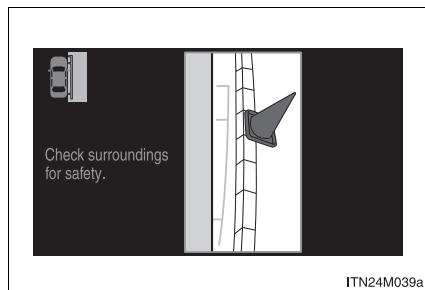

Use the vehicle width line to check the vehicle's distance from objects such as curbstones etc. As shown in the illustration, be sure that the vehicle width line does not overlap the object. If you also move the vehicle so that the vehicle width line and the object are parallel, you can park parallel to the object.

2

When driving

امداد خودرو فارما
تلفن شبانه روزی: ۰۸۵ ۰۸۸۶۲ ۰۲۱

FarmaSOS.com

■ **The wide view front & side monitor can be operated when**

- The “ENGINE START STOP” switch is in IGNITION ON mode.
- The vehicle speed is less than approximately 10 km/h (6 mph).

■ **Automatic system cancelation**

In the following situations, the system is canceled automatically.

- When the vehicle speed exceeds approximately 12 km/h (7 mph).
- When the shift lever is in R.
- When the shift lever is in P. (vehicles with an automatic transmission)

■ **When the outside rear view mirrors have been folded**

The side monitor screen can be displayed even if the outside rear view mirrors have been folded. In this case, there will be a slight difference between the image displayed when the outside rear view mirrors are extended and when the outside rear view mirrors have been folded.

If the side monitor is displayed while the outside rear view mirrors are folded, you cannot check the area near the front edge of the vehicle as the base of the outside rear view mirrors will be in the way.

تلفن شبانه روزی: ۰۲۱-۸۸۶۲۰۸۵

FarmaSOS.com

■ Displayed area

The area covered by the camera is limited. Objects which are close to either corner of the bumper or under the bumper cannot be seen on the screen.

The area displayed on the screen may vary according to vehicle orientation or road conditions.

Front camera

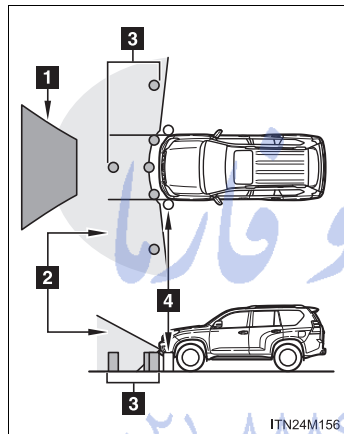

1 Masking

This section is masked to prevent the driver from moving the vehicle while only watching the wide view front monitor screen. The driver must visually confirm this area directly.

2 Camera's field of view

3 Objects visible to the camera

4 Objects not visible to the camera

5 Parts of the vehicle (bumper, grill, etc.)

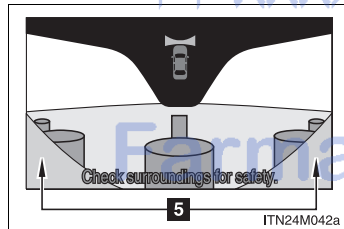

2

When driving

2-4. Using other driving systems

Side camera

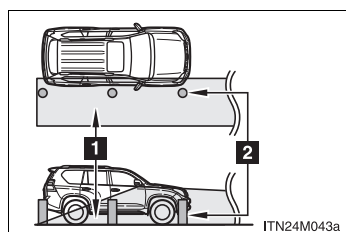

- 1 Camera's field of view
- 2 Objects visible to the camera
- 3 Passenger's side of vehicle

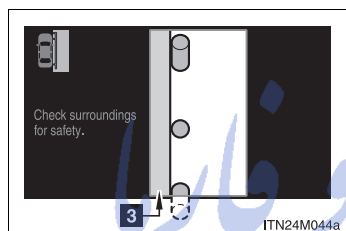

The above illustrations are for a left-hand drive vehicle. In addition, the displayed area is reversed for right-hand drive vehicles.

تلفن شبانه روزی: ۰۲۱-۸۸۶۲۰۸۵

FarmaSOS.com

■ Wide view front & side monitor cameras

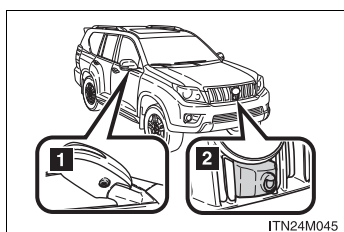

1 Side camera

2 Front camera

The above illustration is for a left-hand drive vehicle. In addition, the side camera is reversed for right-hand drive vehicles.

In the following cases, it may be difficult to see images on the screen even when the system is functioning correctly:

- The vehicle is in a dark area, such as at night.
- The temperature near the lens is extremely high or low.
- Water droplets are on the camera lens or humidity is high, such as when it rains.
- Foreign matter, such as snow and mud, adheres to the camera lens.
- The sun or headlights are shining directly into the camera lens.
- The camera lens is damaged by flying stones.

2

When driving

FarmaSOS.com

2-4. Using other driving systems

■ Smear effect

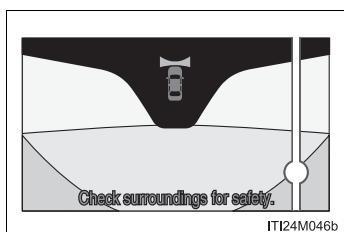

If a bright light, such as sunlight reflected off the vehicle body, is picked up by the camera, a smear effect* characteristic to the camera may occur.

*: Smear effect — A phenomenon that occurs when a bright light is picked up by the camera; when transmitted by the camera, the light source appears to have a vertical streak above and below it. The vertical streak also appears in the masked areas.

⚠ CAUTION

■ When using the wide view front & side monitor system

Observe the following precautions to avoid an accident that could result in death or serious injuries.

- Never depend solely on the monitor system.
- Always check visually and with the mirrors to confirm your intended path is clear.
- Depicted distances between objects and flat surfaces differ from actual distances.
- Do not use the system if the hood or doors are open.

⚠ CAUTION**■ Conditions which may affect the wide view front & side monitor system**

- If the front of the vehicle or the passenger side outside rear view mirror has been hit, the camera's position and mounting angle may have changed. Have the vehicle inspected by any authorized Toyota dealer or repairer, or another duly qualified and equipped professional.
- Rapid temperature changes, such as when hot water is poured on the vehicle in cold weather, may cause the system to function abnormally.
- If the camera lens is extremely dirty, it cannot transmit a clear image. Rinse with water and wipe with a soft cloth. If the camera lens is extremely dirty, wash with a mild cleanser and rinse.
- The displayed image may be darker and moving images may be slightly distorted when the system is cold.
- Situations unsuitable for wide view front & side monitor
 - On icy or slick road surfaces, or in snow.
 - When using tire chains or emergency tires.
 - On roads that are not flat or straight, such as curves or slopes.
- If the tires are changed, the position of the guide lines displayed on the screen may be incorrect. When changing the tires, consult any authorized Toyota dealer or repairer, or another duly qualified and equipped professional.
- Depending on the circumstances of the vehicle (number of passengers, amount of luggage, etc.), the position of the guide lines displayed on the screen may change. Be sure to check visually behind and all around the vehicle before proceeding.

2

When driving

 NOTICE

■ **When using the wide view front & side monitor**

Even if an obstacle is no longer visible on the side monitor, do not turn the steering wheel further in the direction the vehicle is turning until the vehicle has moved completely past the obstacle. If the steering wheel is turned to full lock, the vehicle will turn in the smallest possible turning circle, and may collide with the obstacle.

امداد خودرو فارما

تلفن شبانه روزی: ۰۲۱-۸۸۸۶۲۰۸۵

FarmaSOS.com

2-4. Using other driving systems

Driving assist systems

To help enhance driving safety and performance, the following systems operate automatically in response to various driving situations. Be aware, however, that these systems are supplementary and should not be relied upon too heavily when operating the vehicle.

■ **ABS (Anti-lock Brake System)**

Helps to prevent wheel lock when the brakes are applied suddenly, or if the brakes are applied while driving on a slippery road surface

■ **Multi Terrain ABS (Anti-lock Brake System) (vehicles with a Multi-terrain Select system)**

→Refer to the “Off-road Driving Owner’s Manual”

■ **Brake assist**

Generates an increased level of braking force after the brake pedal is depressed when the system detects a panic stop situation

■ **VSC (Vehicle Stability Control)**

Helps the driver to control skidding when swerving suddenly or turning on slippery road surfaces

■ **TRC (Traction Control) for 2TR-FE engines and H4 mode on 1GR-FE and 1KD-FTV engines**

Helps to maintain drive power and prevent the 4 wheels from spinning when starting the vehicle or accelerating on slippery roads

■ **Active TRC (Traction Control) for L4 mode on 1GR-FE and 1KD-FTV engines***

→Refer to the “Off-road Driving Owner’s Manual”

2-4. Using other driving systems

■ Hill-start assist control (if equipped)

→Refer to the “Off-road Driving Owner’s Manual”

■ KDSS (Kinetic Dynamic Suspension System) (if equipped)

→Refer to the “Off-road Driving Owner’s Manual”

■ PCS (Pre-Crash Safety system) (if equipped)

→P. 380

■ Emergency brake signal (if equipped)

When the brakes are applied suddenly, the stop lights automatically flash to alert the vehicle behind.

*: The function only works in vehicles with Multi-terrain Select when Multi terrain Select is switched on

When the VSC/TRC systems are operating

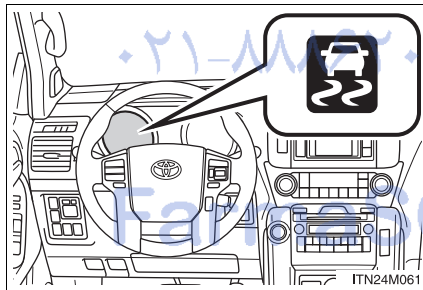

If the vehicle is in danger of slipping or if any of the drive wheels spins, the slip indicator flashes to indicate that the VSC/TRC systems are operating.

A buzzer (intermittent) sounds to indicate that VSC is operating.

Disabling the TRC/VSC systems

If the vehicle gets stuck in fresh snow or mud, the TRC/VSC systems may reduce power from the engine to the wheels. You may need to turn the system off to enable you to rock the vehicle in order to free it.

■ **Turning off TRC system only**

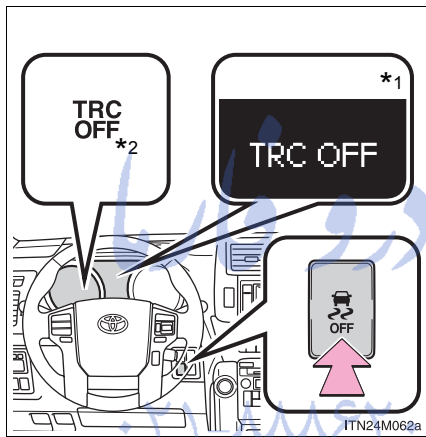

To turn the TRC system off, quickly press and release the button.

The “TRC OFF” indicator light will come on or the TRC OFF will be shown on the multi-information display.

Press the button again to turn the system back on.

*1: Vehicles with an optitron type meters

*2: Vehicles with a non-optitron type meters

2

When driving

FarmaSOS.com

■ Turning off both TRC and VSC systems

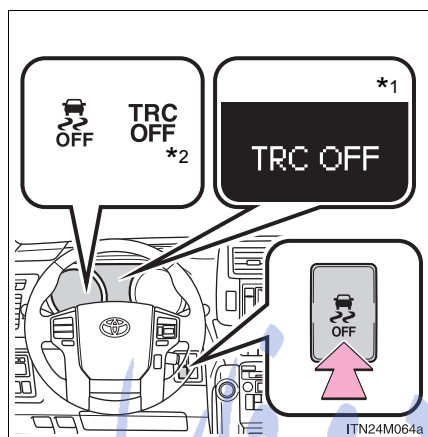

To turn the TRC and VSC systems off, press and hold the button for 3 seconds and more while the vehicle is stopped.

The VSC OFF indicator light will come on and the "TRC OFF" indicator light will come on or TRC OFF will be shown on the multi-information display.

Press the button again to turn the system back on.

*1: Vehicles with an optitron type meters

*2: Vehicles with a non-optitron type meters

تلفن شبانه روزی: ۰۲۱-۸۸۶۲۰۸۵

FarmaSOS.com

■ Sounds and vibrations caused by the ABS, brake assist, VSC and TRC systems

- A sound may be heard from the engine compartment when the engine is started or just after the vehicle begins to move. This sound does not indicate that a malfunction has occurred in any of these systems.
- Any of the following conditions may occur when the above systems are operating. None of these indicates that a malfunction has occurred.
 - Vibrations may be felt through the vehicle body and steering.
 - A motor sound may be heard after the vehicle comes to a stop.
 - The brake pedal may pulsate slightly after the ABS is activated.
 - The brake pedal may move down slightly after the ABS is activated.

■ Reactivation of the TRC/VSC systems after turning off the engine

Turning off the engine after turning off the TRC/VSC systems will automatically reactivate them.

■ Reactivation of the TRC system linked to vehicle speed

When only the TRC system is turned off, the TRC system will turn on when vehicle speed increases. However, when both TRC and VSC systems are turned off, the systems will not turn on even when vehicle speed increases.

■ When the brake system operates continuously

The brake actuator may overheat. In this case, the TRC (vehicles other than 2TR-FE engines) will stop operating, a buzzer will sound and the "TRC OFF" indicator will come on (non-optitron type meters) or the TRC OFF will be shown on the multi-information display (optitron type meters). Refrain from using the system until the "TRC OFF" indicator turns off (non-optitron type meters) or the message goes off (optitron type meters). (There is no problem with continuing normal driving.)

■ **If the slip indicator comes on...**

It may indicate a malfunction in the VSC or TRC system. Consult any authorized Toyota dealer or repairer, or another duly qualified and equipped professional.

 **CAUTION**

■ **The ABS does not operate effectively when**

- The limits of tire gripping performance have been exceeded (such as excessively worn tires on a snow covered road).
- The vehicle hydroplanes while driving at high speed on the wet or slick road.

■ **Stopping distance when the ABS is operating may exceed that of normal conditions**

The ABS is not designed to shorten the vehicle's stopping distance. Always maintain a safe distance from the vehicle in front of you especially in the following situations:

- When driving on dirt, gravel or snow-covered roads
- When driving with tire chains
- When driving over bumps in the road
- When driving over roads with potholes or roads with uneven surfaces

■ **TRC may not operate effectively when**

Directional control and power may not be achievable while driving on slippery road surfaces, even if the TRC system is operating.
Do not drive the vehicle in conditions where stability and power may be lost.

⚠ CAUTION**■ When the VSC is activated**

The slip indicator light flashes and a warning buzzer sounds. Always drive carefully.

Reckless driving may cause an accident. Exercise particular care when the indicator light flashes and a buzzer sounds.

■ When the TRC/VSC systems are turned off

Be especially careful and drive at a speed appropriate to the road conditions. As these are the systems to help enhance vehicle stability and driving force, do not turn the TRC/VSC systems off unless necessary.

■ Replacing tires

Make sure that all tires are of the same size, brand, tread pattern and total load capacity. In addition, make sure that the tires are inflated to the recommended tire inflation pressure level.

The ABS and VSC will not function correctly if different tires are installed on the vehicle.

Contact any authorized Toyota dealer or repairer, or another duly qualified and equipped professional for further information when replacing tires or wheels.

■ Handling of tires and the suspension

Using tires with any kind of problem or modifying the suspension will affect the driving assist systems, and may cause the system to malfunction.

2-4. Using other driving systems

PCS (Pre-Crash Safety system)*

When the radar sensor detects that a frontal collision is highly likely or even unavoidable, safety systems such as the brakes and seat belts are automatically engaged to lessen impact as well as vehicle damage.

■ Pre-crash seat belts (front seat belts only)

If the pre-crash sensor detects that a collision is unavoidable, the pre-crash safety system will retract the seat belt before the collision occurs.

The same will happen if the driver makes an emergency braking or loses control of the vehicle. (→P. 124)

However, when the VSC system is disabled, the system will not operate in the event of skidding.

■ Pre-crash brake assist

When there is a high possibility of a frontal collision, the system applies greater braking force in relation to how strongly the brake pedal is depressed.

■ Pre-crash braking

When there is a high possibility of a frontal collision, the system warns the driver using a warning light, warning display and buzzer. If the system determines that a collision is unavoidable, the brakes are automatically applied to reduce the collision speed. Pre-crash braking can be disabled using the pre-crash braking off switch.

■ AVS (Adaptive Variable Suspension System) control (if equipped)

When the system determines that there is a high possibility of a frontal collision, the AVS optimizes the damping effect (→Refer to the “Off-road Driving Owner’s Manual”)

*: If equipped

Disabling pre-crash braking

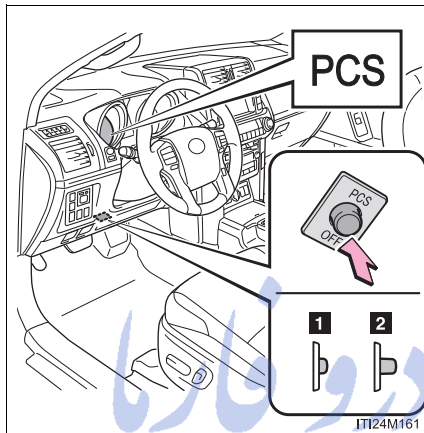

1 Pre-crash braking disabled

2 Pre-crash braking enabled

The "PCS" warning light turns on when pre-crash braking is disabled.

2

When driving

Radar sensor

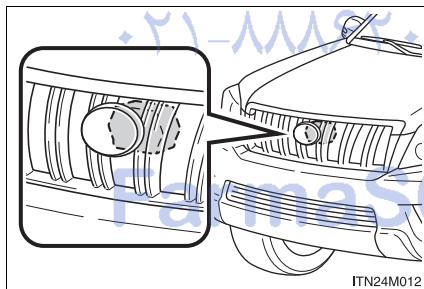

The radar sensor detects vehicles or other obstacles on or near the road ahead and determines whether a collision is imminent based on the position, speed, and heading of the obstacles.

■ **The pre-crash safety system is operational when**

- Pre-crash seat belts (situation 1):
 - Vehicle speed is greater than about 5 km/h (4 mph).
 - The speed at which your vehicle is approaching the obstacle or the vehicle running ahead of you is greater than about 30 km/h (19 mph).
 - The front occupants are wearing a seat belt.
- Pre-crash seat belts (situation 2):
 - Vehicle speed greater than about 30 km/h (19 mph).
 - The system detects sudden braking or skidding.
 - The front occupants are wearing a seat belt.
- Pre-crash brake assist:
 - Vehicle speed is greater than about 30 km/h (19 mph).
 - The speed at which your vehicle is approaching the obstacle or the vehicle running ahead of you is greater than about 30 km/h (19 mph).
 - The brake pedal is depressed.
- Pre-crash braking:
 - The pre-crash braking off switch is not pressed.
 - Vehicle speed is greater than about 15 km/h (10 mph).
 - The speed at which your vehicle is approaching the obstacle or the vehicle running ahead of you is greater than about 15 km/h (10 mph).
- AVS (Adaptive Variable Suspension System) control (if equipped):
 - Vehicle speed is greater than about 5 km/h (4 mph).
 - The speed at which your vehicle is approaching the obstacle or the vehicle running ahead of you is greater than about 30 km/h (19 mph).

■ **Conditions that may trigger the system even if there is no possibility of a collision**

- When there is an object by the roadside at the entrance to a curve
- When passing an oncoming vehicle on a curve
- When driving over a narrow iron bridge
- When there is a metal object on the road surface
- When driving on an uneven road surface
- When passing an oncoming vehicle on a right-turn (right-hand drive vehicles) or left-turn (left-hand drive vehicles)
- When your vehicle rapidly closes on the vehicle in front
- When a grade separation/interchange, sign, billboard, or other structure appears to be directly in the vehicle's line of travel
- When a billboard or other metallic structure appears to be in the direct line of travel due to driving on a hill.
- When an extreme change in vehicle height occurs
- When the axis of the radar is out of adjustment
- When passing through certain toll gates
- When driving on a bridge

When the system is activated in the situations described above, there is also a possibility that the seat belts will retract quickly and the brakes will be applied with a force greater than normal. When the seat belt is locked in the restricted position, stop the vehicle in a safe place, release the seat belt and refasten it.

■ **Situations in which the pre-crash safety system does not function properly**

The system may not function effectively in situations such as the following:

- On roads with sharp bends or uneven surfaces
- If a vehicle suddenly moves in front of your vehicle, such as at an intersection
- If a vehicle suddenly cuts in front of your vehicle, such as when overtaking
- In inclement weather such as heavy rain, fog, snow or sand storms
- When your vehicle is skidding with the VSC system off
- When an extreme change in vehicle height occurs
- When the axis of the radar is out of adjustment

■ **Automatic cancelation of Pre-crash safety system**

When a malfunction occurs due to sensor contaminations, etc. that results in the sensors being unable to detect obstacles, the pre-crash safety system will be automatically disabled. In this case, the system will not activate even if there is a collision possibility.

■ **Obstacles not detected**

The sensor cannot detect plastic obstacles such as traffic cones. There may also be occasions when the radar sensor cannot detect pedestrians, animals, bicycles, motorcycles, trees, or snowdrifts.

■ **When there is a malfunction in the system**

Warning lights and/or warning messages will turn on or flash. (→P. 718)

■ Certification

Hereby, DENSO CORPORATION declares that this DNMWR005 is in compliance with the essential requirements and other relevant provisions of Directive 1999/5/EC.
Hér með lýsir DENSO CORPORATION yfir því að DNMWR005 er í samræmi við grunnkröfur og aðrar kröfur, sem gerðar eru í tilskipun 1999/5/EC.
Con la presente DENSO CORPORATION dichiara che questo DNMWR005 è conforme ai requisiti essenziali ed alle altre disposizioni pertinenti stabilite dalla direttiva 1999/5/CE.
Käesolevaga kinnitab DENSO CORPORATION seadme DNMWR005 vastavust direktiivi 1999/5/EÜ põhinõuetele ja nimetatud direktiivist tulenevatele teistele asjakohastele sätetele.
Hierbij verklaart DENSO CORPORATION dat het toestel DNMWR005 in overeenstemming is met de essentiële eisen en de andere relevante bepalingen van richtlijn 1999/5/EG.
ΜΕ ΤΗΝ ΠΑΡΟΥΣΑ DENSO CORPORATION ΔΗΛΩΝΕΙ ΟΤΙ DNMWR005 ΣΥΜΜΟΡΦΩΝ ΕΤΑΙ ΠΡΟΣ ΤΙΣ ΟΥΣΙΩΔΕΙΣ ΑΠΑΙΤΗΣΕΙΣ ΚΑΙ ΤΙΣ ΛΟΙΠΕΣ ΣΧΕΤΙΚΕΣ ΔΙΑΤΑΞΕΙΣ ΤΗΣ ΟΔΗΓΙΑΣ 1999/5/ΕΚ.
Härmed intygar DENSO CORPORATION att denna DNMWR005 står i överensstämmelse med de väsentliga egenskapskrav och övriga relevanta bestämmelser som framgår av direktiv 1999/5/EG.
Por medio de la presente DENSO CORPORATION declara que el DNMWR005 cumple con los requisitos esenciales y cualesquiera otras disposiciones aplicables o exigibles de la Directiva 1999/5/CE.
DENSO CORPORATION týmto vyhlasuje, že DNMWR005 spĺňa základné požiadavky a všetky príslušné ustanovenia Smernice 1999/5/ES.
DENSO CORPORATION izjavlja, da je ta DNMWR005 v skladu z bistvenimi zahtevami in ostalimi relevantnimi določili direktive 1999/5/ES.
DENSO CORPORATION tímto prohlašuje, že tento DNMWR005 je ve shodě se základními požadavky a dalšími příslušnými ustanoveními směrnice 1999/5/ES.

2

When driving

2-4. Using other driving systems

Undertegnede DENSO CORPORATION erklærer herved, at følgende udstyr DNMWR005 overholder de væsentlige krav og øvrige relevante krav i direktiv 1999/5/EF.
Hiermit erklärt DENSO CORPORATION, dass sich das Gerät DNMWR005 in Übereinstimmung mit den grundlegenden Anforderungen und den übrigen einschlägigen Bestimmungen der Richtlinie 1999/5/EG befindet.
DENSO CORPORATION erklærer herved at utstyret DNMWR005 er i samsvar med de grunnleggende krav og øvrige relevante krav i direktiv 1999/5/EF.
Alulírott, DENSO CORPORATION nyilatkozom, hogy a DNMWR005 megfelel a vonatkozó alapvető követelményeknek és az 1999/5/EC irányelv egyéb előírásainak.
DENSO CORPORATION vakuuttaa täten että DNMWR005 tyyppinen laite on direktiivin 1999/5/EY oleellisten vaatimusten ja sitä koskevien direktiivin muiden ehtojen mukainen.
Par la présente DENSO CORPORATION déclare que l'appareil DNMWR005 est conforme aux exigences essentielles et aux autres dispositions pertinentes de la directive 1999/5/CE.
Niniejszym DENSO CORPORATION oświadcza, że DNMWR005 jest zgodny z zasadniczymi wymogami oraz pozostałymi stosownymi postanowieniami Dyrektywy 1999/5/EC.
DENSO CORPORATION declara que este DNMWR005 está conforme com os requisitos essenciais e outras disposições da Directiva 1999/5/CE.
Hawnhekk, DENSO CORPORATION, jiddikjara li dan DNMWR005 jikkonforma mal-htigijiet essenzjali u ma provvedimenti oħrajn relevanti li hemm fid-Dirrettiva 1999/5/EC.
Ar šo, DENSO CORPORATION, deklarē, ka DNMWR005 atbilst Direktīvas 1999/5/EK būtiskajām prasībām un citiem ar to saistītajiem noteikumiem.
Šiuo DENSO CORPORATION deklaruoja, kad šis DNMWR005 atitinka esminius reikalavimus ir kitas 1999/5/EB Direktyvos nuostatas.

⚠ CAUTION**■ Limitations of the pre-crash safety system**

Do not overly rely on the pre-crash safety system. Always drive safely, taking care to observe your surroundings and checking for any obstacles or other road hazards.

Failure to do so may cause an accident resulting in death or serious injury.

■ Cautions regarding the assist contents of the system

By means of alarms and brake control, the pre-crash safety system is intended to assist the driver in avoiding collisions through the process of LOOK-JUDGE-ACT. There are limits to the degree of assistance the system can provide, so please keep in mind the following important points.

- **Assisting the driver in watching the road**
The pre-crash safety system is only able to detect obstacles directly in front of the vehicle, and only within a limited range. It is not a mechanism that allows careless or inattentive driving, and it is not a system that can assist the driver in low-visibility conditions. It is still necessary for the driver to pay close attention to the vehicle's surroundings.
- **Assisting the driver in making correct judgment**
When attempting to estimate the possibility of a collision, the only data available to the pre-crash safety system is that from obstacles it has detected directly in front of the vehicle. Therefore, it is absolutely necessary for the driver to remain vigilant and to determine whether or not there is a possibility of collision in any given situation.
- **Assisting the driver in taking action**
The pre-crash safety system's braking assist feature is designed to help reduce the severity of a collision, and so only acts when the system has judged that a collision is unavoidable. This system by itself is not capable of automatically avoiding a collision or bringing the vehicle to a stop safely. For this reason, when encountering a dangerous situation the driver must take direct and immediate action in order to ensure the safety of all involved.

 CAUTION

■ **When the sensor may not be correctly detecting the vehicle ahead**

Apply the brakes as necessary in any of the following situations.

- When water or snow thrown up by the surrounding vehicles hinders the functioning of the sensor
- When your vehicle is pointing upwards (caused by a heavy load in the luggage compartment etc.)
- Vehicles that cut in suddenly
- Vehicles with small rear ends (trailers with no load on board etc.)
- Motorcycles traveling in the same lane

■ **Handling the radar sensor**

Observe the following to ensure the pre-crash safety system can function effectively:

- Keep the sensor and front grille clean at all times.
Clean the sensor and front grille with a soft cloth so you do not mark or damage them.
- Do not subject the sensor or surrounding area to a strong impact.
If the sensor moves even slightly off position, the system may become inaccurate or malfunction. If the sensor or surrounding area is subject to a strong impact, always have the area inspected and adjusted by any authorized Toyota dealer or repairer, or another duly qualified and equipped professional.
- Do not disassemble the sensor.
- Do not attach accessories or stickers to the sensor, grille or surrounding area.
- Do not modify or paint the sensor and grille cover.

2-4. Using other driving systems

Diesel Particulate Filter system (diesel engine only)*

When the deposit collected by the filter reaches a predetermined amount, it is automatically regenerated.

■ Regeneration

Regeneration is performed as necessary in accordance with driving conditions.

■ System characteristics

The DPF system has the following characteristics:

- Idle speed increases during regeneration
- The smell of the exhaust gas differs from that of a conventional diesel vehicle

DPF system failure warning

- If the DPF system warning light comes on (vehicle with non-optitron type meters) or the DPF system warning message “DPF FULL SEE OWNER’S MANUAL” appears on the display (vehicle with an optitron type meters), Driving continuously. (→P. 716, 741)
- If the DPF system warning light flashes (vehicle with non-optitron type meters) or the DPF system warning message “DPF FULL ENGINE SERVICE REQUIRED” appears on the display (vehicle with an optitron type meters), have the vehicle inspected by any authorized Toyota dealer or repairer, or another duly qualified and equipped professional, immediately. (→P. 707, 722)

2

When driving

*: If equipped

■ **Replacing the engine oil**

Make sure to use an oil of the recommended grade or of matching quality.
(→P. 827)

■ **DPF system warning**

Under the following driving conditions, the DPF system warning light or message may come on earlier than normal.*

- When only driving at low speeds (for example 20 km/h [12 mph] or below).
- If the engine is turned on and off frequently (if the engine is not left running for more than 10 minutes at a time).

*: Differs in accordance with weather, driving conditions, etc.

 **CAUTION**

■ **Exhaust pipe**

Do not touch the exhaust pipe during regeneration, as the exhaust pipe and exhaust gases will become particularly hot. Also, make sure that there are no people or flammable materials near the exhaust pipe while the vehicle is stopped.

Failure to do so may cause injury by burning or a fire.

■ **If the malfunction indicator light comes on**

The malfunction indicator light comes on if you continue driving while the DPF system warning light is flashing (vehicles with non-optitron type meters), or the DPF warning message “DPF FULL ENGINE SERVICE REQUIRED” appears on the display (vehicles with a optitron type meters). In this event, damage may be caused to the vehicle or an accident may occur. Have the vehicle inspected by any authorized Toyota dealer or repairer, or another duly qualified and equipped professional, immediately.

 NOTICE

■ **To prevent the DPF system from failing**

- Vehicles with non-optitron type meters: Do not drive for long periods of time while the DPF system warning light is flashing
- Vehicles with an optitron type meters: Do not drive for long periods of time while the DPF system warning message "DPF FULL ENGINE SERVICE REQUIRED" appears on the display.
- Do not use fuel other than the specified type
- Do not use engine oil other than the recommended type
- Do not modify the exhaust pipe

2

When driving

امداد خودرو فارما
تلفن شبانه روزی: ۰۲۱-۸۸۸۶۲۰۸۵

FarmaSOS.com

2-5. Driving information

Cargo and luggage

Take notice of the following information about storage precautions, cargo capacity and load:

- Stow cargo and luggage in the luggage compartment whenever possible.
- Be sure all items are secured in place.
- To maintain vehicle balance while driving, position luggage evenly within the luggage compartment.
- For better fuel economy, do not carry unnecessary weight.

Roof luggage carrier (if equipped)

■ Roof luggage carrier components

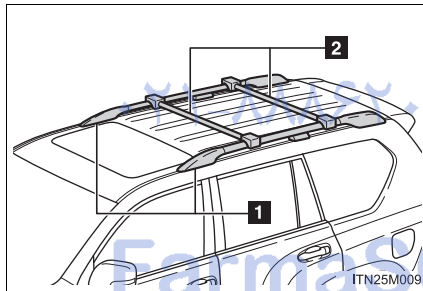

1 Roof rail

2 Cross rail

⚠ CAUTION**■ Things that must not be carried in the luggage compartment**

The following things may cause a fire if loaded in the luggage compartment:

- Receptacles containing gasoline
- Aerosol cans

■ Storage precautions

Observe the following precautions.

Failure to do so may result in death or serious injury.

- Stow cargo and luggage in the luggage compartment whenever possible.
- Do not stack anything in the luggage compartment higher than the seat-backs.
Such items may be thrown about and possibly injure people in the vehicle in the event of a sudden braking, sudden swerving or an accident.
- Do not place cargo or luggage in or on the following locations as the item may get under the clutch, brake or accelerator pedal and prevent the pedals from being depressed properly, block the driver's vision, or hit the driver or passengers, causing an accident:
 - At the feet of the driver
 - On the front passenger or rear seats (when stacking items)
 - On the luggage cover
 - On the instrument panel
 - On the dashboard

2

When driving

 CAUTION

■ **Storage precautions**

- Secure all items in the occupant compartment, as they may shift and injure someone in the event of a sudden braking, sudden swerving or an accident.
- When you fold down the rear seats, long items should not be placed directly behind the front seats.
- Never allow anyone to ride in the luggage compartment. It is not designed for passengers. They should ride in their seats with their seat belts properly fastened. Otherwise, they are much more likely to suffer death or serious bodily injury, in the event of a sudden braking, sudden swerving or an accident.

■ **Roof luggage carrier precautions**

To use the roof rails as a roof luggage carrier, you must fit the roof rails with two or more genuine Toyota cross rails or their equivalent.

Follow the manufacturer's instructions and precautions when installing the cross rails or their equivalent.

■ **Load and distribution**

- Do not overload your vehicle.
- Do not apply loads unevenly.
Improper loading may cause deterioration of steering or braking control which may cause death or serious injury.

⚠ CAUTION**■ When loading cargo**

Observe the following precautions:

- Place the cargo so that its weight is distributed evenly between the front and rear axles.
- If loading long or wide cargo, never exceed the vehicle overall length or width. (→P. 812)
- Before driving, make sure the cargo is securely fastened on the roof luggage carrier.
- Loading cargo on the roof luggage carrier will make the center of gravity of the vehicle higher. Avoid high speeds, sudden starts, sharp turns, sudden braking or abrupt maneuvers, otherwise it may result in loss of control or vehicle rollover due to failure to operate this vehicle correctly and result in death or serious injury.
- If driving for a long distance, on rough roads, or at high speeds, stop the vehicle now and then during the trip to make sure the cargo remains in its place.
- Do not exceed 80 kg (176 lb.) cargo weight on the roof luggage carrier.

⚠ NOTICE**■ When loading cargo (vehicles with a moon roof)**

Be careful not to scratch the surface of the moon roof.

2

When driving

2-5. Driving information

Winter driving tips

Carry out the necessary preparations and inspections before driving the vehicle in winter. Always drive the vehicle in a manner appropriate to the prevailing weather conditions.

■ Pre-winter preparations

- Use fluids that are appropriate to the prevailing outside temperatures.
 - Engine oil
 - Engine coolant
 - Washer fluid
- Have a service technician inspect the level and specific gravity of battery electrolyte.
- Have the vehicle fitted with four snow tires or purchase a set of tire chains for the rear tires.

Ensure that all tires are the same size and brand, and that chains match the size of the tires.

تلفن شبانه روزی: ۰۲۱-۸۸۶۲۰۸۵

FarmaSOS.com

■ Before driving the vehicle

Perform the following according to the driving conditions:

- Do not try to forcibly open a window or move a wiper that is frozen. Pour warm water over the frozen area to melt the ice. Wipe away the water immediately to prevent it from freezing.
- To ensure proper operation of the climate control system fan, remove any snow that has accumulated on the air inlet vents in front of the windshield.
- Remove any ice that has accumulated on the vehicle chassis.
- Periodically check for and remove any excess ice or snow that may have accumulated in the wheel well or on the brakes.

■ When driving the vehicle

Accelerate the vehicle slowly and drive at a reduced speed suitable to road conditions.

■ When parking the vehicle (in the winter time or in the cold latitudes)

Park the vehicle and move the shift lever to P (automatic transmission) or 1 or R (manual transmission) without setting the parking brake. The parking brake may freeze up, preventing it from being released. If necessary, block the wheels to prevent inadvertent sliding or creeping.

Selecting tire chains

Use the correct tire chain size when mounting the snow chains. Chain size is regulated for each tire size.

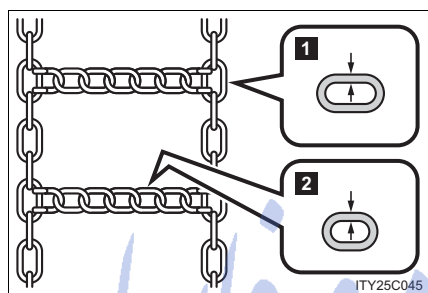

- 1** Side chain
(5 mm [0.20 in.] in diameter)
- 2** Cross chain
(6.3 mm [0.25 in.] in diameter)

Regulations on the use of tire chains

Regulations regarding the use of tire chains vary depending on location and type of road. Always check local regulations before installing chains.

تلفن شبانه روزی: ۰۲۱-۸۸۶۲۰۸۵

■ Tire chain installation

Observe the following precautions when installing and removing chains:

- Install and remove tire chains in a safe location.
- Install tire chains on the rear tires. Do not install tire chains on the front tires.
- Install tire chains on rear tires as tightly as possible. Retighten chains after driving 0.5 - 1.0 km (1/4 - 1/2 mile).
- Install tire chains following the instructions provided with the tire chains.

⚠ CAUTION**■ Driving with snow tires**

Observe the following precautions to reduce the risk of accidents. Failing to do so may result in a loss of vehicle control and cause death or serious injury.

- Use tires of the specified size.
- Maintain the recommended level of air pressure.
- Do not drive at speeds in excess of the speed limit or the speed limit specified for the snow tires being used.
- Use snow tires on all, not just some wheels.

■ Driving with tire chains

Observe the following precautions to reduce the risk of accidents. Failing to do so may result in the vehicle being unable to be driven safely, and may cause death or serious injury.

- Do not drive in excess of the speed limit specified for the tire chains being used, or 50 km/h (30 mph), whichever is lower.
- Avoid driving on bumpy road surfaces or over potholes.
- Avoid sudden turns and braking, as use of chains may adversely affect vehicle handling.
- Slow down sufficiently before entering a curve to ensure that vehicle control is maintained.

2-5. Driving information

Trailer towing

Your vehicle is designed primarily as a passenger carrying vehicle. Towing a trailer will have an adverse effect on handling, performance, braking, durability, and fuel consumption. Your safety and satisfaction depend on the proper use of correct equipment and cautious driving habits. For your safety and the safety of others, do not overload the vehicle or trailer.

To tow a trailer safely, use extreme care and drive the vehicle in accordance with the trailer's characteristics and operating conditions.

Toyota warranties do not apply to damage or malfunction caused by towing a trailer for commercial purposes.

Ask your local authorized Toyota dealer or repairer, or another duly qualified and equipped professional for further details before towing, as there are additional legal requirements in some countries.

■ Weight limits

Check the allowable towing capacity, GVM (Gross Vehicle Mass), MPAC (Maximum Permissible Axle Capacity), and permissible draw bar load before towing. (→P. 812)

■ Towing hitch/bracket

Toyota recommends the use of the Toyota hitch/bracket for your vehicle. Other products of a suitable nature and comparable quality may also be used.

Selecting a trailer ball

Use the correct trailer ball for your application.

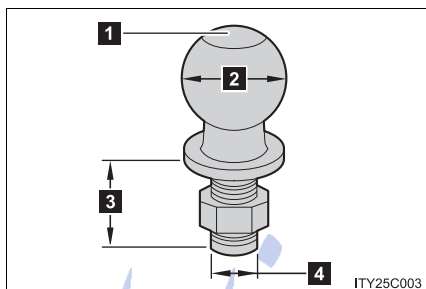

1 Trailer ball load rating

Matches or exceeds the gross trailer weight rating of the trailer.

2 Ball diameter

Matches the size of the trailer coupler. Most couplers are stamped with the required trailer ball size.

3 Shank length

Protrudes beyond the bottom of the lock washer and nut at least 2 threads.

4 Shank diameter

Matches the ball mount hole diameter size.

2

When driving

Connecting trailer lights

Use the wire harness stored in the rear end.

Important points regarding trailer loads

■ Total trailer weight and permissible drawbar load

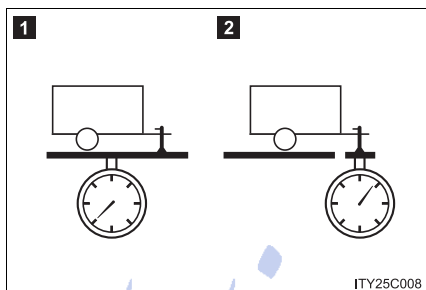

1 Total trailer weight

Weight of the trailer itself plus the trailer load should be within the maximum towing capacity. Exceeding this weight is dangerous. (→P. 812)

When towing a trailer, use a friction coupler or friction stabilizer (sway control device).

When the total trailer weight is over 2000 kg (4409 lb.), a friction stabilizer (sway control device) is required.

2 Permissible drawbar load

Allocate the trailer load so that the drawbar load is greater than 25 kg (55.1 lb.) or 4 % of the towing capacity. Do not let the drawbar load exceed the indicated weight. (→P. 812)

■ Information tag (manufacturer's label)

Type A

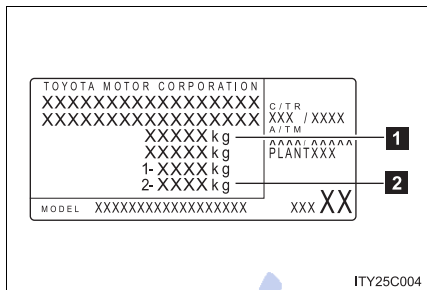

- 1 Gross vehicle mass
- 2 Maximum permissible rear axle capacity

Type B

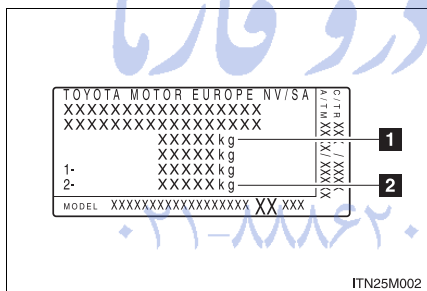

2

When driving

امداد خودرو فارما

تلفن شبانه روزی: ۰۲۱-۸۸۶۲۰۸۵

FarmaSOS.com

- **Gross vehicle mass**

Vehicle category M1 models*:

The combined weight of the driver, passengers, luggage, towing hitch, total curb mass and drawbar load should not exceed the gross vehicle mass by more than 100 kg (220.5 lb.). Exceeding this weight is dangerous.

Vehicle category N1 models*:

The combined weight of the driver, passengers, cargo, towing hitch, total curb mass and drawbar load must not exceed the gross vehicle mass. Exceeding this weight is dangerous.

- **Maximum permissible rear axle capacity**

Vehicle category M1 models*:

The weight borne by the rear axle should not exceed the maximum permissible axle capacity by 15 % or more. Exceeding this weight is dangerous.

Vehicle category N1 models*:

The weight borne by the rear axle should not exceed the maximum permissible axle capacity. Exceeding this weight is dangerous.

The values for towing capacity were derived from testing conducted at sea level. Take note that engine output and towing capacity will be reduced at high altitudes.

 CAUTION

■ **Vehicle category M1 models*:** When the gross vehicle mass limit or maximum permissible axle capacity is exceeded

Do not exceed the established speed limit for towing a trailer in built-up areas or 100 km/h (63 mph), whichever is lower.
Failing to observe this precaution may lead to an accident causing death or serious injury.

*: To distinguish the vehicle category, ask any authorized Toyota dealer or repairer, or another duly qualified and equipped professional.

2

When driving

امداد خودرو فارما

تلفن شبانه روزی: ۰۲۱-۸۸۸۶۲۰۸۵

FarmaSOS.com

■ **When connecting and disconnecting a trailer (vehicles with rear height control air suspension)**

● Connecting

STEP 1 Set the rear height control air suspension to LO mode.

STEP 2 Turn off the “ENGINE START STOP” switch or the rear height control air suspension.

STEP 3 Connect the trailer.

STEP 4 Turn on the switch that was turned off on step 2.

STEP 5 Set the rear height control air suspension to N mode.

● Disconnecting

STEP 1 Set the rear height control air suspension to LO mode.

STEP 2 Turn off the rear height control air suspension.

STEP 3 Turn off the “ENGINE START STOP” switch.

STEP 4 Set the supporting leg of a trailer on the ground and raise the hitch by 100 mm (4 in.).

STEP 5 Turn on the “ENGINE START STOP” switch.

STEP 6 Turn on the rear height control air suspension.

STEP 7 Wait until vehicle height is stabilized.

Make sure the hitch is disconnected. If the hitch does not disconnect, raise the hitch higher and repeat steps 2 through 7.

Installation positions for the towing hitch/bracket and hitch ball

5-door models

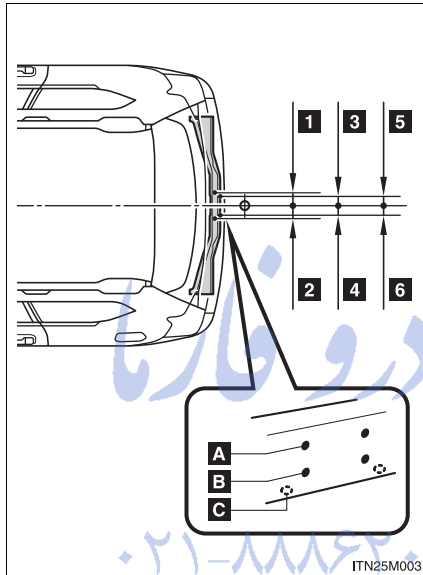

- 1** 78 mm (3.0 in.)
- 2** 78 mm (3.0 in.)
- 3** 53 mm (2.1 in.)
- 4** 53 mm (2.1 in.)
- 5** 53 mm (2.1 in.)
- 6** 53 mm (2.1 in.)
- 7** 1219 mm (48.0 in.)
- 8** 137 mm (5.4 in.)^{*1}
141 mm (5.6 in.)^{*2}
- 9** 79 mm (3.1 in.)^{*1}
83 mm (3.3 in.)^{*2}
- 10** 54 mm (2.1 in.)^{*1}
58 mm (2.3 in.)^{*2}
- 11** 428 mm (16.9 in.)^{*1}
336 mm (13.2 in.)^{*2}

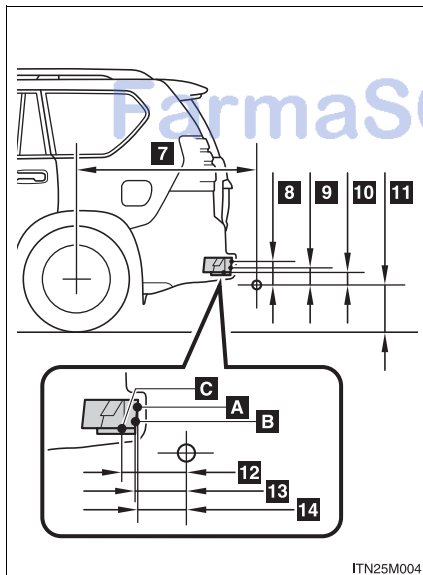

- 7** 200 mm (7.9 in.)^{*1}
199 mm (7.8 in.)^{*2}
- 8** 171 mm (6.7 in.)^{*1}
169 mm (6.7 in.)^{*2}
- 9** 171 mm (6.7 in.)^{*1}
168 mm (6.6 in.)^{*2}
- 10** 171 mm (6.7 in.)^{*1}
168 mm (6.6 in.)^{*2}
- 11** 171 mm (6.7 in.)^{*1}
168 mm (6.6 in.)^{*2}
- 12** 200 mm (7.9 in.)^{*1}
199 mm (7.8 in.)^{*2}
- 13** 171 mm (6.7 in.)^{*1}
169 mm (6.7 in.)^{*2}
- 14** 171 mm (6.7 in.)^{*1}
168 mm (6.6 in.)^{*2}

^{*1}: Vehicles with rear height control air suspension

^{*2}: Vehicles without rear height control air suspension

3-door models

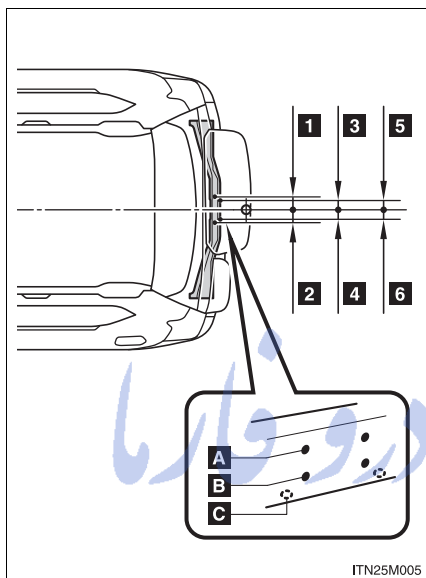

- 1** 78 mm (3.0 in.)
- 2** 78 mm (3.0 in.)
- 3** 53 mm (2.1 in.)
- 4** 53 mm (2.1 in.)
- 5** 53 mm (2.1 in.)
- 6** 53 mm (2.1 in.)
- 7** 1110 mm (43.7 in.)
- 8** 142 mm (5.6 in.)
- 9** 84 mm (3.3 in.)
- 10** 59 mm (2.3 in.)
- 11** 327 mm (12.9 in.)
- 12** 199 mm (7.8 in.)
- 13** 169 mm (6.7 in.)
- 14** 167 mm (6.6 in.)

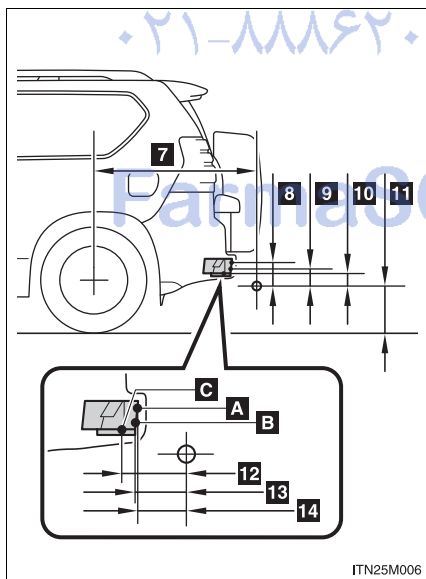

■ Tire information

- On some models, increase the tire inflation pressure to 20.0 kPa (0.2 kgf/cm² or bar, 3 psi) greater than the recommended value when towing. (→P. 840)
- Increase the air pressure of the trailer tires in accordance with the total trailer weight and according to the values recommended by the manufacturer of your trailer.

■ Trailer lights

Check that the turn signal lights and stoplights are operating correctly every time you hitch up the trailer. Directly wiring up to your vehicle may damage the electrical system and stop the lights from functioning correctly.

■ Break-in schedule

Toyota recommends that vehicles fitted with new power train components should not be used for towing trailers for the first 800 km (500 miles).

■ Safety checks before towing

- Check that the maximum load limit for the towing hitch/bracket hitch ball is not exceeded. Bear in mind that the coupling weight of the trailer will add to the load exerted on the vehicle. Also make sure that the total load exerted on the vehicle is within the range of the weight limits. (→P. 402)
- Ensure that the trailer load is secure.
- Supplementary outside rear view mirrors should be added to the vehicle if the traffic behind cannot be clearly seen with standard mirrors. Adjust the extending arms of these mirrors on both sides of the vehicle so that they always provide maximum visibility of the road behind.

■ **Maintenance**

- Maintenance must be performed more frequently when using the vehicle for towing due to the greater weight burden placed on the vehicle compared to normal driving.
- Retighten all bolts securing the hitching ball and bracket after towing for approximately 1000 km (600 miles).

 **CAUTION**

■ **To avoid accident or injury**

For vehicles with the rear height control air suspension, set the vehicle height to the low mode and turn off the electronically modulated air suspension to prevent the vehicle height from automatically changing.

 **NOTICE**

■ **When the rear bumper strengthening material is aluminum**

Ensure the steel bracket part does not come directly in contact with that area.

When steel and aluminum come into contact, there is a reaction similar to corrosion, which will weaken the section concerned which may result in damage. Apply a rust inhibitor to parts that will come in contact when attaching a steel bracket.

Guidance

Your vehicle will handle differently when towing a trailer. In order to avoid accident, death or serious injury, keep the following in mind when towing:

■ Checking connections between trailer and lights

Stop the vehicle and check the operation of the connection between the trailer and lights after driving for a brief period as well as before starting off.

■ Practicing driving with a coupled trailer

- Get the feel for turning, stopping and reversing with the trailer coupled by practicing in an area with no or light traffic.
- When reversing with a coupled trailer, hold the section of the steering wheel nearest to you and rotate clockwise to turn the trailer left or counterclockwise to turn it right. Always rotate a little at a time to prevent steering error. Have someone guide you when reversing to lessen the risk of accident.

■ Increasing vehicle-to-vehicle distance

At a speed of 10 km/h (6 mph), the distance to the vehicle running ahead of you should be equivalent to or greater than the combined length of your vehicle and trailer. Avoid sudden braking that may cause skidding. Otherwise, the vehicle may spin out of control. This is especially true when driving on wet or slippery road surfaces.

■ **Sudden acceleration/steering input/cornering**

Executing sharp turns when towing may result in the trailer colliding with your vehicle. Decelerate well in advance when approaching turns and take them slowly and carefully to avoid sudden braking.

■ **Important points regarding turning**

The wheels of the trailer will travel closer to the inside of the curve than the wheels of the vehicle. To make allowance for this, take the turns wider than you would normally do.

■ **Important points regarding stability**

Vehicle movement resulting from uneven road surfaces and strong crosswinds will affect handling. The vehicle may also be rocked by passing buses or large trucks. Frequently check behind when moving alongside such vehicles. As soon as such vehicle movement occurs, immediately start to decelerate smoothly by slowly applying the brakes. Always steer the vehicle straight ahead while braking.

■ **Passing other vehicles**

Consider the total combined length of your vehicle and trailer and ensure that the vehicle-to-vehicle distance is sufficient before executing lane changes.

■ Transmission information

Refrain from driving in the 6th gear (6-speed manual transmission) or 5th gear (5-speed manual transmission), 5 range in S mode (multi-mode type automatic transmission) or 4 (standard type automatic transmission) to maintain the effectiveness of the engine brake and the charge performance of electrical components.

■ If the engine overheats

Towing a loaded trailer up a long, steep incline in temperatures exceeding 30 °C (85 °F) may result in the engine overheating. If the engine coolant temperature gauge indicates that the engine is overheating, turn the air conditioning off immediately, leave the road and stop the vehicle in a safe place. (→P. 803)

■ When parking the vehicle

Always place wheel chocks under the wheels of both the vehicle and trailer. Firmly set the parking brake and shift the shift lever to P for automatic transmissions, and 1 or R for manual transmissions.

2

When driving

تلفن شبانه روزی: ۰۲۱-۸۸۶۲۰۸۵

FarmaSOS.com

 CAUTION

Follow all the precautions described in this section. Failure to do so could cause an accident resulting in death or serious injury.

■ **Trailer towing precautions**

When towing, make sure that none of the weight limits are exceeded.
(→P. 402)

■ **Vehicle speed in towing**

Observe the legal maximum speeds for trailer towing.

■ **Before descending hills or long declines**

Reduce speed and downshift. Never downshift abruptly.

■ **Operation of the brake pedal**

Do not hold the brake pedal depressed often or for long periods of time.
Doing so may result in the brake overheating or reduce braking effects.

 NOTICE

■ **For vehicles with an emergency tire puncture repair kit (if equipped)**

Do not tow anything if a tire that has been repaired using the emergency tire puncture repair kit is installed. The load on the tire may cause unexpected damage to the tire.

■ **Do not directly splice trailer lights**

Directly splicing trailer lights may damage your vehicle's electrical system and cause a malfunction.

امداد خودرو فارما

تلفن شبانه روزی: ۰۲۱-۸۸۸۶۲۰۸۵

FarmaSOS.com

3-1. Using the air conditioning system and defogger	3-2. Using the audio system
Front manual air conditioning system 418	Audio system types..... 449
Front automatic air conditioning system 425	Using the radio..... 453
Rear manual air conditioning system 435	Using the CD player..... 458
Rear automatic air conditioning system 438	Playing MP3 and WMA discs..... 468
Heater idle up switch 442	Operating an iPod..... 477
Power heater 443	Operating a USB memory 486
Rear window defogger switch 444	Optimal use of the audio system 496
Windshield wiper de-icer 447	Using the AUX port..... 499
	Using the steering wheel audio switches 501
	3-3. Using the Bluetooth® audio system
	Bluetooth® audio system 504
	Using the Bluetooth® audio system 511
	Operating a Bluetooth® enabled portable player..... 514
	Setting up a Bluetooth® enabled portable player..... 518
	Bluetooth® audio system setup 522

3-4. Using the hands-free system (for mobile phone)

Hands-free system (for mobile phone) 523

Using the hands-free system (for mobile phone) 532

Making a phone call..... 539

Setting a mobile phone 543

Security and system setup..... 546

Using the phone book..... 551

3-5. Using the interior lights

Interior lights list..... 557

- Personal/interior light main switch..... 558
- Personal/interior lights 559
- Lounge illumination control switches 560

3-6. Using the storage features

List of storage features 562

- Glove box 563
- Card holder..... 564
- Console box..... 565
- Bottle holders/door pockets 567
- Cup holders 569
- Auxiliary boxes 573

3-7. Other interior features

Cool box..... 576

Sun visors 579

Vanity mirror 580

Clock..... 581

Outside temperature display 582

Ashtray..... 584

Conversation mirror 585

Power outlet..... 586

Seat heaters 590

Armrest 593

Coat hooks..... 594

Assist grips 595

Floor mat..... 596

Luggage compartment features..... 598

3-1. Using the air conditioning system and defogger Front manual air conditioning system*

The illustration below is for left-hand drive vehicles.
The button positions and shapes may differ slightly for right-hand drive vehicles.

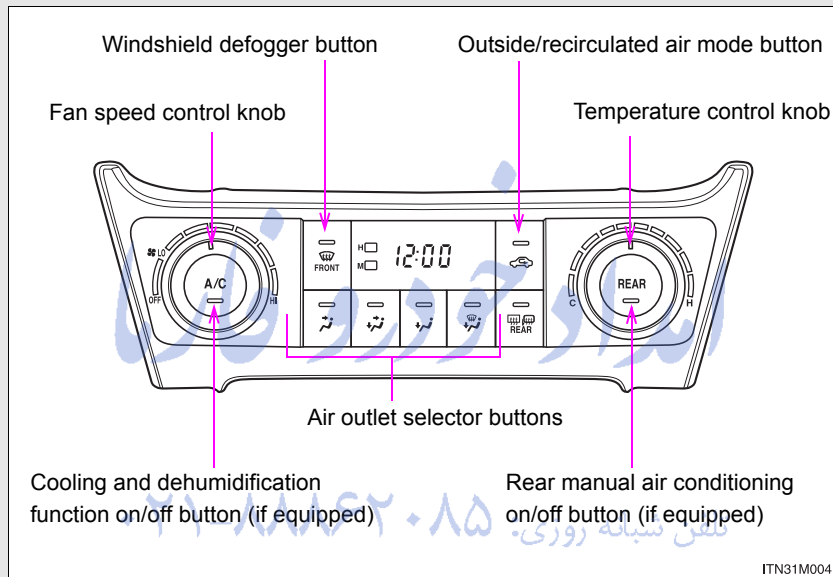

FarmaSOS.com

*: If equipped

Adjusting the settings

■ Basic setting



STEP 1 To turn on the air conditioning system and adjust the fan speed, turn the fan speed control knob clockwise (increase) or counterclockwise (decrease).

Turning the knob to "OFF" turns off the fan.

STEP 2 To adjust the temperature setting, turn the temperature control knob clockwise (warm) or counterclockwise (cool).

If the "A/C" button is not pressed, the system will blow ambient temperature air or heated air.

STEP 3 To change the air outlets, press any button of  ,  ,

 or  .

Air flow as shown below according to the mode selected.

تلفن شبانه روزی: ۰۲۱-۸۸۶۲۰۸۵

FarmaSOS.com

3-1. Using the air conditioning system and defogger

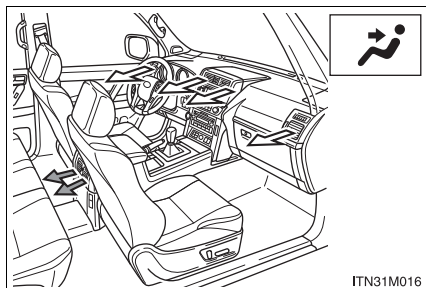

Air flows to the upper body.

← : Some models

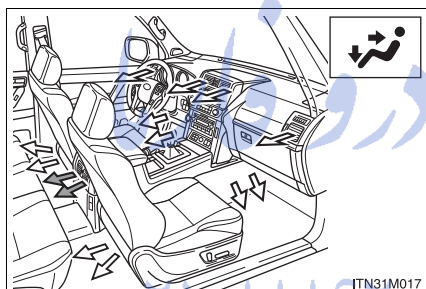

Air flows to the upper body and feet.

← : Some models

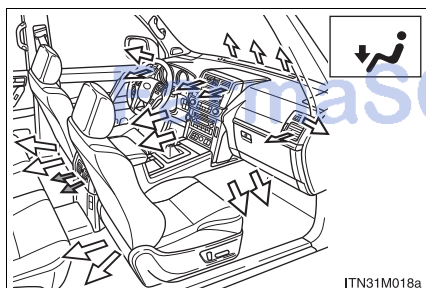

Air flows to the feet.

← : Some models

3-1. Using the air conditioning system and defogger

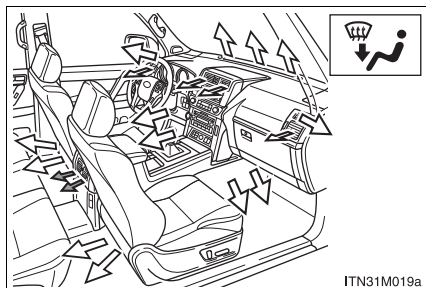

Air flows to the feet and the windshield defogger operates.

← : Some models

■ Switching between outside air and recirculated air modes

Press



The mode switches between outside air mode (introduces air from outside the vehicle) (indicator off) and recirculated air mode (recycles air inside the vehicle) (indicator on) each time the button is pressed.

تلفن شبانه روزی: ۰۲۱-۸۸۶۲۰۸۵

FarmaSOS.com

3

Interior features

3-1. Using the air conditioning system and defogger

Defogging the windshield

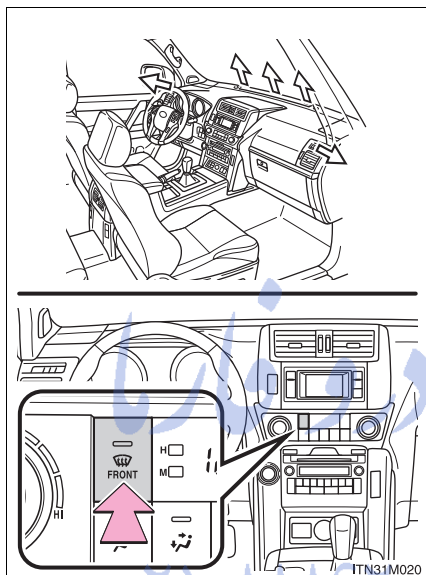

Defogging

The air intake is automatically switched to outside air mode.

Pressing the “A/C” button to turn the cooling and dehumidification function on clears the windshield and side windows faster.

Adjusting the position of and opening and closing the air outlets

Front center outlets

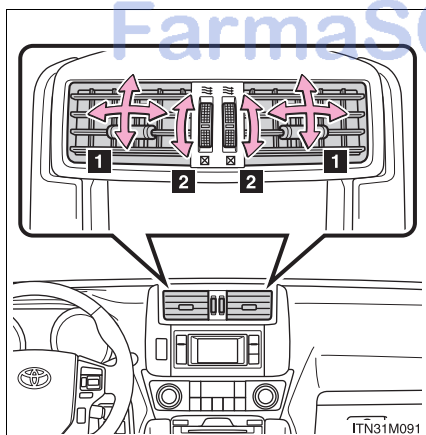

- 1 Direct air flow to the left or right, up or down.
- 2 Turn the knob to open or close the vent.

Front side outlets

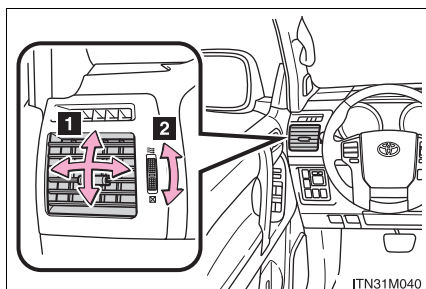

- 1 Direct air flow to the left or right, up or down.
- 2 Turn the knob to open or close the vent.

Rear outlets (vehicles without a rear manual air conditioning system)

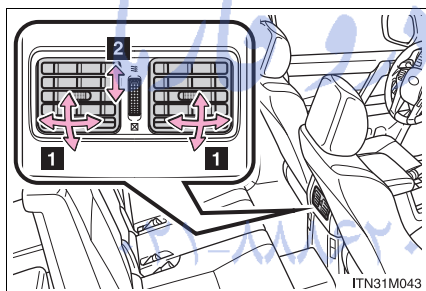

- 1 Direct air flow to the left or right, up or down.
- 2 Turn the knob to open or close the vent.

■ Using the system in recirculated air mode

The windows will fog up more easily if recirculated air mode is used for an extended period of time.

3-1. Using the air conditioning system and defogger

■ When the indicator light on the “A/C” button flashes

Press the “A/C” button to turn off the cooling and dehumidification function and turn it on again. There may be a problem in the air conditioning system if the indicator light continues to flash. Turn the air conditioning system off and have it inspected by any authorized Toyota dealer or repairer, or another duly qualified and equipped professional.

■ When outside air temperature is below 0 °C (32 °F)

The cooling and dehumidification function may not operate even when the “A/C” button is pressed.

■ Air conditioning odors

- During use, various odors from inside and outside the vehicle may enter into and accumulate in the air conditioning system. This may then cause odor to be emitted from the vents.
- To reduce potential odors from occurring:
It is recommended that the air conditioning system be set to outside air mode prior to turning the vehicle off.

CAUTION

■ To prevent the windshield from fogging up

Do not use  during cool air operation in extremely humid weather. The difference between the temperature of the outside air and that of the windshield can cause the outer surface of the windshield to fog up, blocking your vision.

NOTICE

■ To prevent battery discharge

Do not leave the air conditioning system on longer than necessary when the engine is stopped.

3-1. Using the air conditioning system and defogger Front automatic air conditioning system*

Air outlets and fan speed are automatically adjusted according to the temperature setting.

The illustration below is for left-hand drive vehicles.

The button positions and shapes may differ slightly for right-hand drive vehicles.

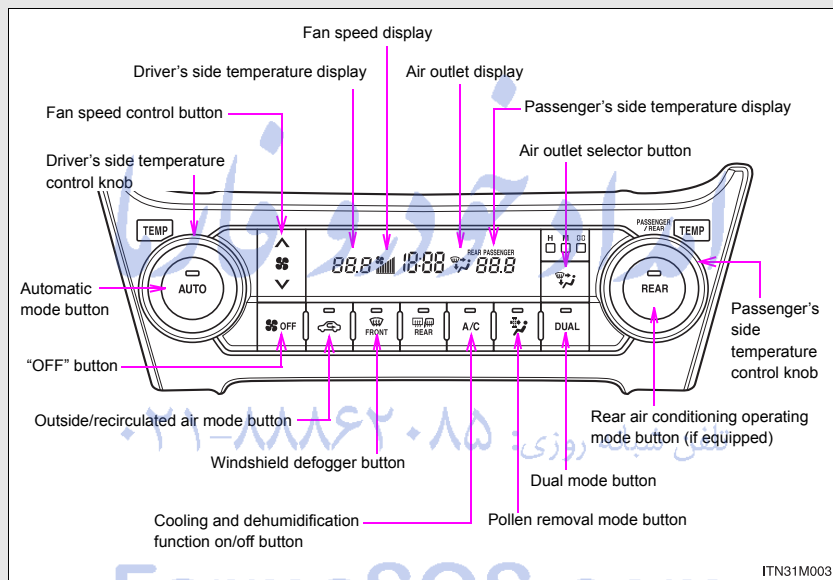

*: If equipped

Using the automatic air conditioning system

STEP 1 Press the “AUTO” button.

The air conditioning system begins to operate. Air outlets and fan speed are automatically adjusted according to the temperature setting.

STEP 2 Turn the “TEMP” knob (driver’s side) clockwise to increase the temperature and turn the “TEMP” knob (driver’s side) counterclockwise to decrease the temperature.

When the “DUAL” button is pressed (the indicator on the “DUAL” button is on) or the passenger’s side temperature control knob is turned, the temperature for the driver and passenger seats can be adjusted separately.

Adjusting the settings manually

■ Basic setting

STEP 1 To turn on the air conditioning system and adjust the fan

speed, press “^” on  to increase the fan speed and “v” to decrease the fan speed.

Press  to turn the fan off.

STEP 2 To adjust the temperature setting, turn the “TEMP” knob (driver’s side) clockwise to increase the temperature and turn the “TEMP” knob (driver’s side) counterclockwise to decrease the temperature.

When the “DUAL” button is pressed (the indicator on the “DUAL” button is on) or the passenger’s side temperature control knob is turned, the temperature for the driver and passenger seats can be adjusted separately.

3-1. Using the air conditioning system and defogger

STEP 3 To change the air outlets, press the air outlet selector button.

The air outlets used are switched each time the button is pressed.

The air flow shown on the display indicates the following:

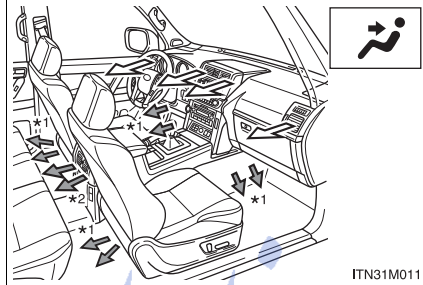

Air flows to the upper body.

← *1: Only in the automatic mode (Air may not always flow.)

← *2: Some models

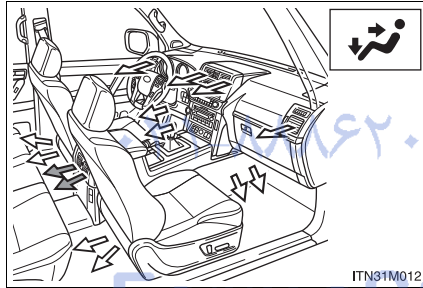

Air flows to the upper body and feet.

← : Some models

3

Interior features

3-1. Using the air conditioning system and defogger

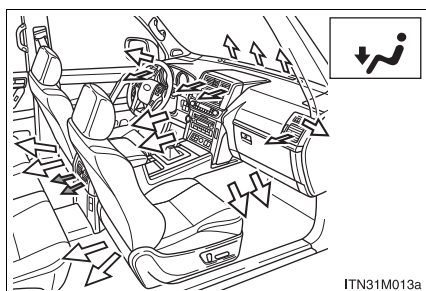

Air flows to the feet.

← : Some models

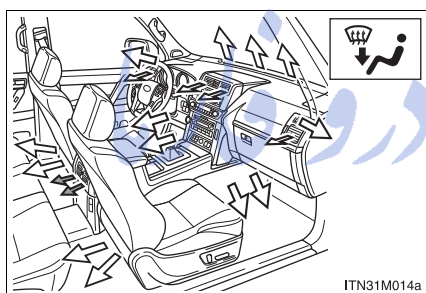

Air flows to the feet and the windshield defogger operates.

← : Some models

■ Switching between outside air and recirculated air modes

Press  .

The mode switches between outside air mode (introduces air from outside the vehicle) (indicator off) and recirculated air mode (recycles air inside the vehicle) (indicator on) each time the button is pressed.

Changing the rear seat settings (vehicles with a rear automatic air conditioning system)

■ **Adjusting the temperature setting**

STEP 1 Press the “REAR” button.

“REAR” is shown on the display.

STEP 2 Turn the “TEMP” knob (passenger’s side) clockwise to increases the temperature and turn the “TEMP” knob (passenger’s side) counterclockwise to decreases the temperature.

■ **Adjusting the fan speed**

Press “^” on  to increase the fan speed and “v” to decrease the fan speed.

Press  to turn the fan off.

■ **Changing the air outlets**

Press  .

The air outlets switch each time the button is pressed (→P. 439)

3-1. Using the air conditioning system and defogger

Defogging the windshield

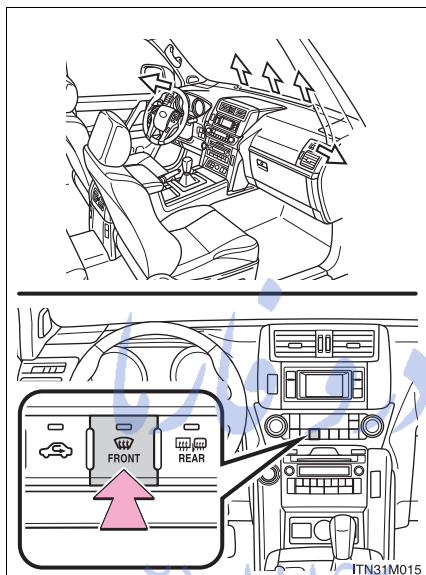

Defogging

The air conditioning system operates automatically.

Recirculated air mode may automatically switch to outside air mode when the ambient temperature is low.

Pollen removal mode button

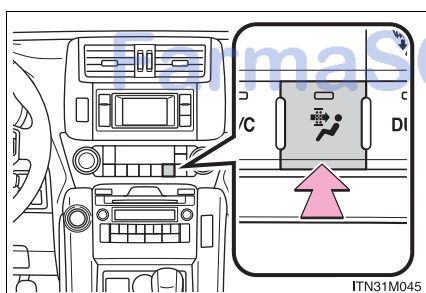

Operates pollen removal mode on/off.

Outside air mode switches to recirculated air mode. Pollen is removed from the air and the air flows to the upper part of the body.

Usually the system will turn off automatically after approximately 3 minutes.

Adjusting the position and opening and closing the air outlets

Front center outlets

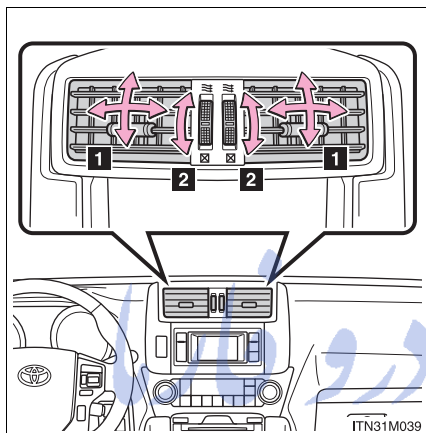

- 1 Direct air flow to the left or right, up or down.
- 2 Turn the knob to open or close the vent.

Front side outlets

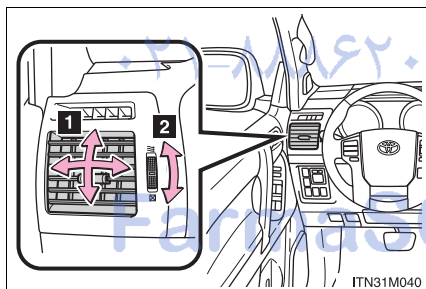

- 1 Direct air flow to the left or right, up or down.
- 2 Turn the knob to open or close the vent.

Rear outlets (vehicles without a rear automatic air conditioning system)

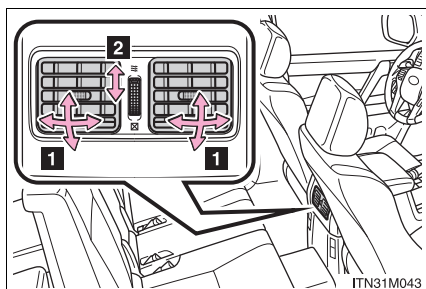

- 1** Direct air flow to the left or right, up or down.
- 2** Turn the knob to open or close the vent.

■ **Using automatic mode**

Fan speed is adjusted automatically according to the temperature setting and ambient conditions. As a result, the following may occur.

- Immediately after the switch is pressed, the fan may stop for a while until warm or cool air is ready to flow.
- Cool air may flow to the area around the upper body when the heater is on.

■ **Switching between outside air and recirculated air modes**

Recirculated air mode or outside air mode may be automatically switched to in accordance with the temperature setting, inside temperature, outside temperature, etc.

■ **Using the system in recirculated air mode**

The windows will fog up more easily if the recirculated air mode is used.

■ **Window defogger feature**

Recirculated air mode may automatically switch to outside air mode in situations where the windows need to be defogged.

■ **Pollen removal mode**

- In order to prevent the windows from fogging up when the outside air is cold, the following may occur.
 - Outside air mode does not switch to recirculated air mode.
 - The air conditioning system operates automatically.
 - The operation cancels after 1 minute.

- In rainy weather, the windows may fog up. Press  .

■ **When the indicator light on the “A/C” button flashes**

Press the “A/C” button to turn off the cooling and dehumidification function and turn it on again. There may be a problem in the air conditioning control system if the indicator light continues to flash. Turn the air conditioning system off and have it inspected by any authorized Toyota dealer or repairer, or another duly qualified and equipped professional.

■ **When outside air temperature is below 0 °C (32 °F)**

The cooling and dehumidification function may not operate even when the “A/C” button is pressed.

■ **Using the rear automatic air conditioning system**

- When the rear automatic air conditioning system is on, the indicator light on the “REAR” button is turned on.
- If the system is left untouched for approximately 10 seconds after changing to the rear automatic air conditioning system, the control mode in the front control panel returns to the front.

3-1. Using the air conditioning system and defogger

■ Air conditioning odors

- During use, various odors from inside and outside the vehicle may enter into and accumulate in the air conditioning system. This may then cause odor to be emitted from the vents.
- To reduce potential odors from occurring:
 - It is recommended that the air conditioning system be set to outside air mode prior to turning the vehicle off.
 - The start timing of the blower may be delayed for a short period of time immediately after the air conditioning system is started in automatic mode.

■ Customization

Settings (e.g. A/C automatic mode button operation) can be changed.
(Customizable features →P. 849)

CAUTION

■ To prevent the windshield from fogging up

Do not use  during cool air operation in extremely humid weather. The difference between the temperature of the outside air and that of the windshield can cause the outer surface of the windshield to fog up, blocking your vision.

NOTICE

■ To prevent battery discharge

Do not leave the air conditioning system on longer than necessary when the engine is stopped.

3-1. Using the air conditioning system and defogger Rear manual air conditioning system*

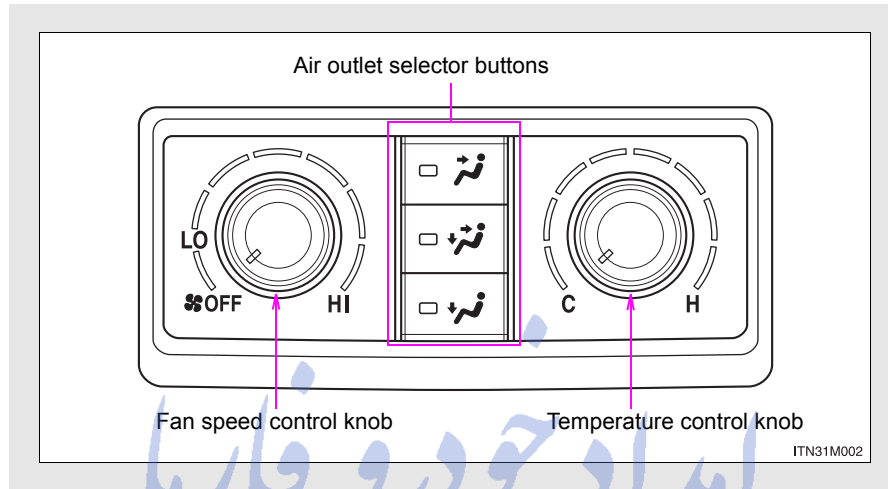

Using the rear manual air conditioning system

Press the “REAR” button on the front manual air conditioning control panel.

Adjusting the settings

■ Adjusting the temperature setting

Turn the temperature knob clockwise (warm) or counter-clockwise (cool).

■ Changing the air outlets

Press any button of  ,  or  .

Air flows as shown below according to the mode selected.

*: If equipped

3-1. Using the air conditioning system and defogger

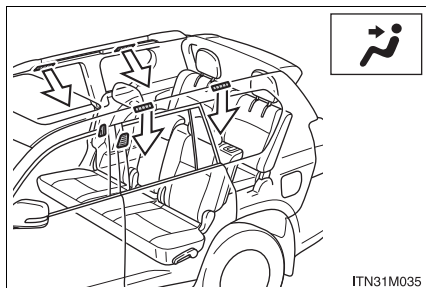

Air flows to the upper body.

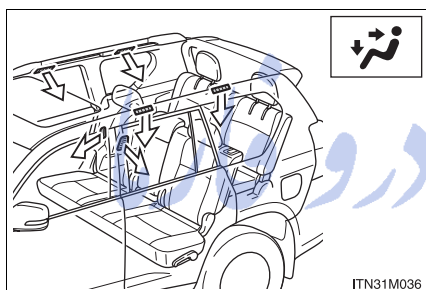

Air flows to the upper body and feet.

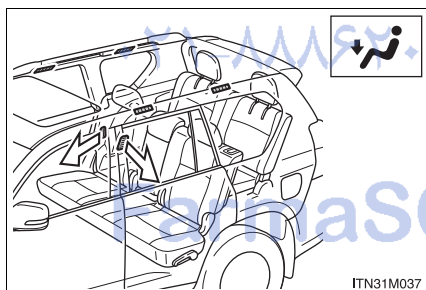

Air flows to the feet.

■ Adjusting the fan speed

Turn the air volume control knob clockwise (increase) or counter-clockwise (decrease).

Adjusting the position of and opening and closing the air outlets

Roof side outlets

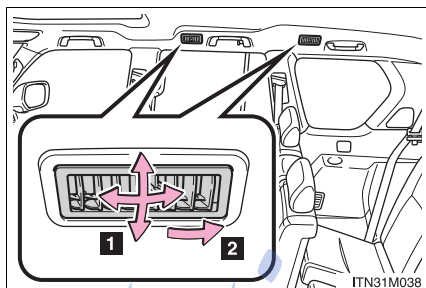

- 1 Direct air flow to the left or right, up or down.
- 2 Turn the knob fully to the back of the vehicle to close the vent.

NOTICE

■ To prevent battery discharge

Do not leave the air conditioning system on longer than necessary when the engine is stopped.

3-1. Using the air conditioning system and defogger Rear automatic air conditioning system*

Air outlets and fan speed are automatically adjusted according to the temperature setting.

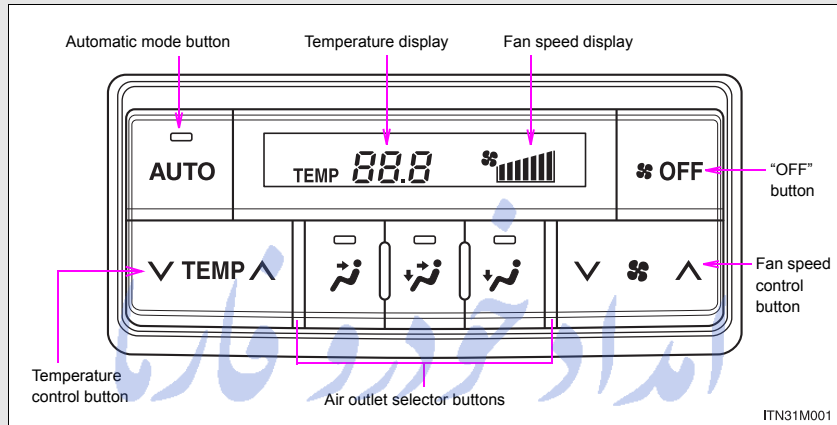

Using automatic air conditioning system

STEP 1 Press the "AUTO" button.

The air conditioning system will operate, and air outlets and fan speed will be adjusted automatically.

STEP 2 Press " \wedge " on the "TEMP" button to increase the temperature and " \vee " to decrease the temperature.

*: If equipped

Adjusting the settings manually

■ Adjusting the temperature setting

Press “^” on the “TEMP” button to increase the temperature and “v” to decrease the temperature.

■ Changing the air outlets

Press any button of  ,  or  .

Air flows as shown below according to the mode selected.

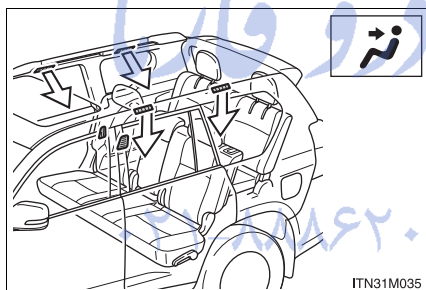

Air flows to the upper body.

3-1. Using the air conditioning system and defogger

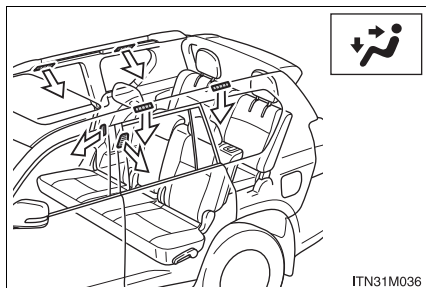

Air flows to the upper body and feet.

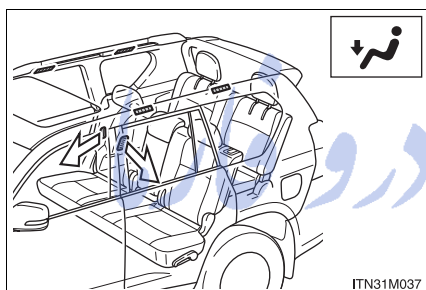

Air flows to the feet.

■ Adjusting the fan speed

Press “^” (increase) or “v” (decrease) on .

Pressing  turns off the fan.

Adjusting the position and opening and closing the air outlets

Roof side outlets

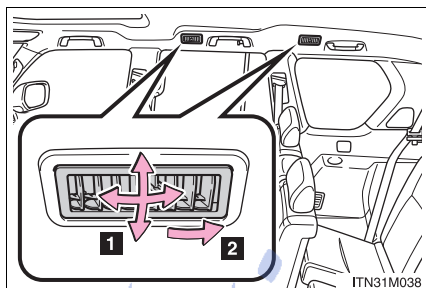

- 1 Direct air flow to the left or right, up or down.
- 2 Turn the knob fully to the back of the vehicle to close the vent.

NOTICE

■ To prevent battery discharge

Do not leave the air conditioning system on longer than necessary when the engine is stopped.

3-1. Using the air conditioning system and defogger Heater idle up switch*

This feature is used to boost heating effect in extremely cold conditions when the vehicle is not moving.

Left-hand drive vehicles

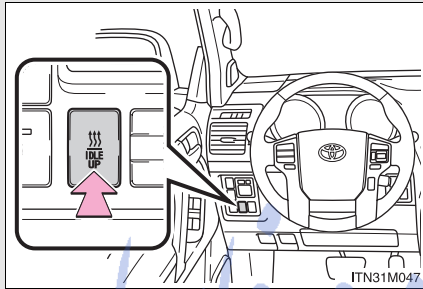

Press the switch to increase engine speed.

Press the switch again to return the engine to the normal idle speed. If you do not turn the switch to off, the engine speed is increased whenever the engine is started.

Right-hand drive vehicles

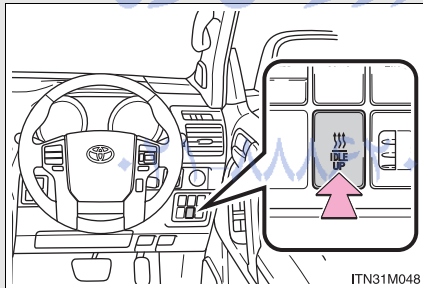

Press the switch to increase engine speed.

Press the switch again to return the engine to the normal idle speed. If you do not turn the switch to off, the engine speed is increased whenever the engine is started.

■ Heater idle up switch can be operated when

- The engine is running.
- The engine coolant temperature is low.

*: If equipped

3-1. Using the air conditioning system and defogger Power heater*

This feature is used to heat the engine coolant, speed up warming of the cab in cold weather, and keep the cab warm.

Left-hand drive vehicles

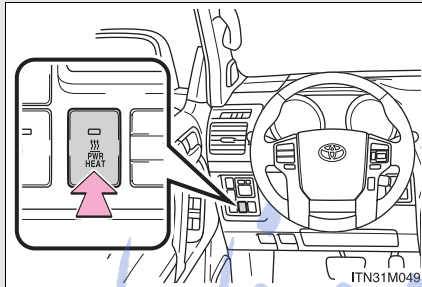

Turns the power heater on/off

If you do not turn the switch to off, the engine speed is increased whenever the engine is started.

Right-hand drive vehicles

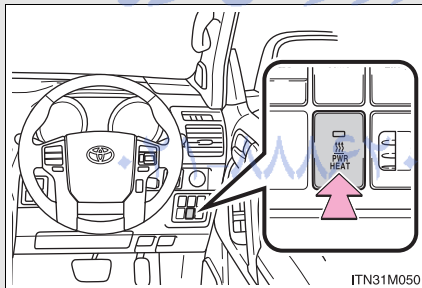

Turns the power heater on/off

If you do not turn the switch to off, the engine speed is increased whenever the engine is started.

■ Power heater can be operated when

- The engine is running.
- The engine coolant temperature is low.

*: If equipped

3-1. Using the air conditioning system and defogger

Rear window defogger switch

Defoggers are used to defog the rear window, and to remove rain-drops, dew and frost from the outside rear view mirrors (if equipped).

The illustrations below are for left-hand drive vehicles.

The button positions and shapes may differ slightly for right-hand drive vehicles.

Vehicles with a front manual air conditioning system

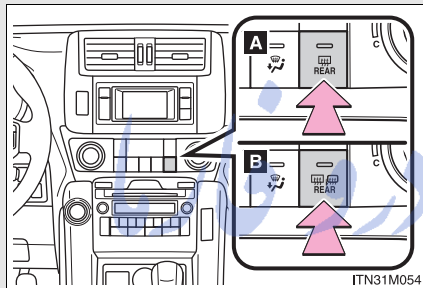

A Vehicles without the outside rear view mirror defoggers

B Vehicles with the outside rear view mirror defoggers

Turns the defoggers on/off

The defoggers will automatically turn off after their operation time. The operation time is between 15 minutes and 270 minutes depending on the ambient temperature and vehicle speed.

FarmaSOS.com

3-1. Using the air conditioning system and defogger

Vehicles with a front automatic air conditioning system

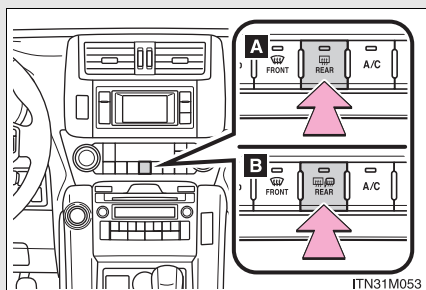

A Vehicles without the outside rear view mirror defoggers

B Vehicles with the outside rear view mirror defoggers

Turns the defoggers on/off

The defoggers will automatically turn off after their operation time. The operation time is between 15 minutes and 270 minutes depending on the ambient temperature and vehicle speed.

تلفن شبانه روزی: ۰۲۱-۸۸۶۲۰۸۵

FarmaSOS.com

3

Interior features

3-1. Using the air conditioning system and defogger

■ The defoggers can be operated when

Vehicles without a smart entry & start system

The engine switch is in the "ON" position.

Vehicles with a smart entry & start system

The "ENGINE START STOP" switch is in IGNITION ON mode.

■ The outside rear view mirror defoggers (vehicles with the outside rear view mirror defoggers)

Turning the rear window defogger on will turn the outside rear view mirror defoggers on.

CAUTION

■ When the outside rear view mirror defoggers are on (vehicles with the outside rear view mirror defoggers)

Do not touch the outside surface of the rear view mirrors, as they can become very hot and burn you.

تلفن شبانه روزی: ۰۲۱-۸۸۶۲۰۸۵

FarmaSOS.com

3-1. Using the air conditioning system and defogger Windshield wiper de-icer*

This feature is used to prevent ice from building up on the windshield and wiper blades.

Left-hand drive vehicles

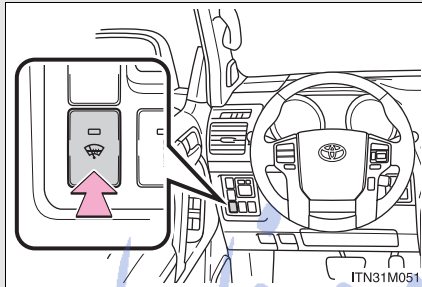

Turns the windshield wiper de-icer on/off

The windshield wiper de-icer will automatically turn off after approximately 15 minutes.

Right-hand drive vehicles

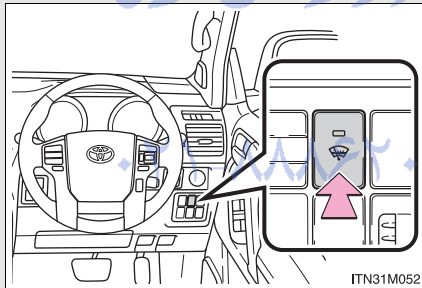

Turns the windshield wiper de-icer on/off

The windshield wiper de-icer will automatically turn off after approximately 15 minutes.

*: If equipped

3-1. Using the air conditioning system and defogger

■ **The windshield wiper de-icer can be operated when**

Vehicles without a smart entry & start system

The engine switch is in the “ON” position.

Vehicles with a smart entry & start system

The “ENGINE START STOP” switch is in IGNITION ON mode.

 **CAUTION**

■ **When the windshield wiper de-icer is on**

Do not touch the lower part of the windshield or the side of the front pillars, as the surfaces can become very hot and burn you.

تلفن شبانه روزی: ۰۲۱-۸۸۶۲۰۸۵

FarmaSOS.com

3-2. Using the audio system

Audio system types*

Vehicles with a navigation system

Refer to the "Navigation System Owner's Manual".

Vehicles without a navigation system

Type A and B: CD player with AM/FM radio

Type C: CD player with a changer and AM/FM radio

Type A

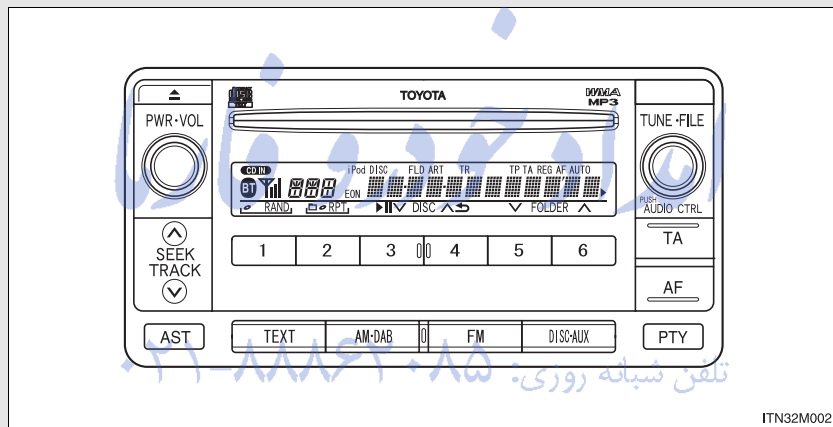

3

Interior features

FarmaSOS.com

*: If equipped

3-2. Using the audio system

Type B

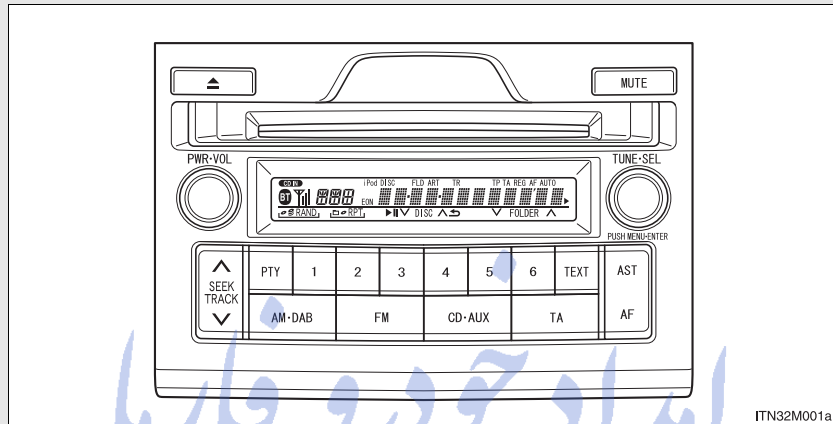

Type C

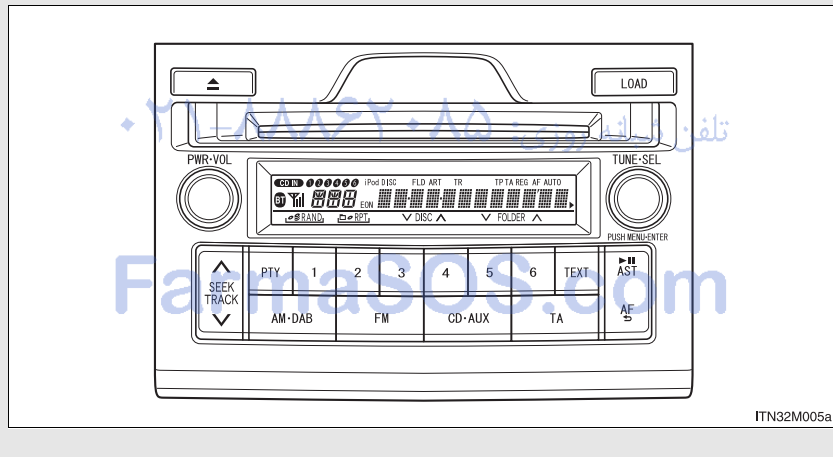

Title	Page
Using the radio	P. 453
Using the CD player	P. 458
Playing MP3 and WMA discs	P. 468
Operating an iPod	P. 477
Operating a USB memory	P. 486
Optimal use of the audio system	P. 496
Using the AUX port	P. 499
Using the steering switches	P. 501

■ Using mobile phones

Interference may be heard through the audio system's speakers if a mobile phone is being used inside or close to the vehicle while the audio system is operating.

FarmaSOS.com

3-2. Using the audio system

CAUTION

■ Certification for the radio (for Italy)

IL PRODUTTORE PIONEER CORPORATION 4-1, Meguro 1-Chome, Meguro-Ku, Tokyo, Japan DI QUESTO APPARECCHIO MODELLO 86120-60C00, 86120-60C20, 86120-60D20 (radio-CD player) DICHIARA CHE ESSO E' CONFORME AL D.M.28.08.1995 No.548, OTTEMPERANDO ALLE PRESCRIZIONI DI CUI AL D.M.25.6.1985 (PARAGRAFO 3, ALL.A) ED AL D.M.27.8.1987 (PARAGRAFO 3, ALL.I).

■ Certification for the disc player with a changer

This product is a class 1 laser product.

- Do not open the cover of the player or attempt to repair the unit yourself. Refer servicing to qualified personnel.
- Laser power: No hazardous

NOTICE

■ To prevent battery discharge

Do not leave the audio system on longer than necessary with the engine off.

■ To avoid damaging the audio system

Take care not to spill drinks or other fluids over the audio system.

3-2. Using the audio system

Using the radio

Type A

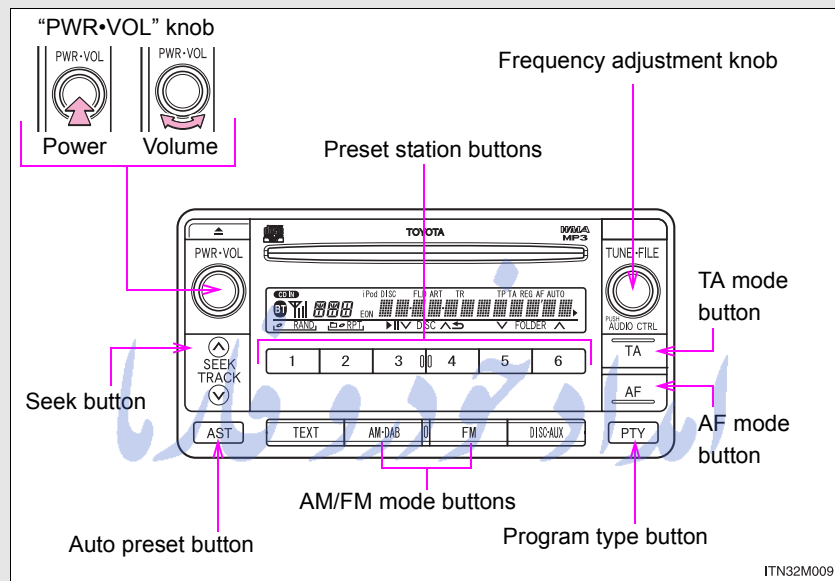

Type B and C

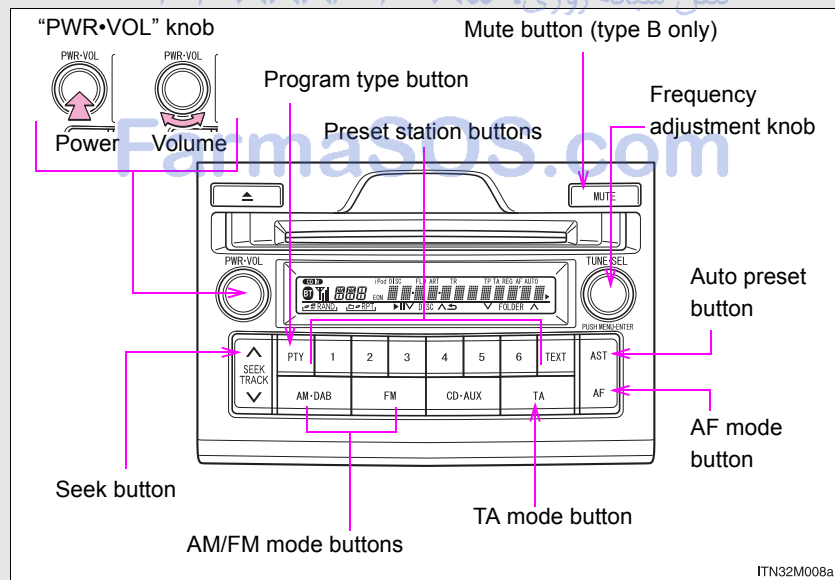

Setting station presets

■ Manually operation

STEP 1 Search for the desired stations by turning the “TUNE•FILE” or “TUNE•SEL” knob or pressing “^” or “v” on the “SEEK/TRACK” button.

STEP 2 Press and hold the button (from the 1 button to the 6 button) the station is to be set to until you hear a beep.

■ Automatically operation

Press and hold the “AST” button until you hear a beep.

Up to 6 stations are set in order of reception quality. When the setting is complete, 2 beeps will be heard.

In the FM1 or FM2 mode, the stations automatically set by the audio system will be set in the FM3 presets.

تلفن شبانه روزی: ۰۲۱-۸۸۶۲۰۸۵

FarmaSOS.com

RDS (Radio Data System)

This feature allows your radio to receive station and program information (classical, news, etc.) from radio stations which broadcast this information.

■ Listening to stations of the same network

Press the “AF” button.

“AF-ON”, “REG-OFF” modes: A station among those of the same network with strong reception is selected.

“AF-ON”, “REG-ON” modes: A station among those of the same network with strong reception and broadcasting the same program is selected.

Each time the “AF” button is pressed, the mode changes in the following order:

“AF-ON”, “REG-OFF” → “AF-ON”, “REG-ON” → “AF-OFF”, “REG-OFF”.

■ Selecting program type

Press the “PTY” button.

Each time the “PTY” button is pressed, the program type changes in the following order:

“NEWS” → “SPORTS” → “TALK” → “POP” → “CLASSICS”.

■ **Traffic information**

Press the “TA” button.

TP mode: The system automatically switches to traffic information when a broadcast with a traffic information signal is received.

The station returns to the previous one when the traffic information ends.

TA mode: Traffic information can be heard only when a signal is received. The system switches to the mute mode when a signal is not received. In CD or MP3/WMA mode, the system automatically switches to traffic information when a signal is received.

The audio system returns to the mute, CD or MP3/WMA mode when the traffic information ends.

Audio system mode changes as follows each time the “TA” button is pressed:

FM modes: “TP” → “TA” → off
Modes other than the radio modes: “TA” → off

■ **Emergency broadcast reception mode**

“ALARM” appears in the display in the event that an emergency broadcast is received, and the emergency broadcast is aired.

Silencing the sound (type B)

Press the “MUTE” button.

Press the button again to turn the system back on.

■ **EON (Enhanced Other Network) system (for traffic announcement function)**

If the RDS station (with EON data) you are listening to is not broadcasting a traffic information program and the audio system is in the TA (traffic announcement) mode, the radio will be switched automatically to a station broadcasting a traffic information program in the EON AF list when traffic information begins.

■ **When the battery is disconnected**

All preset stations are erased.

■ **Reception sensitivity**

- It is difficult to maintain perfect radio reception at all times due to the continually changing position of the antenna, differences in signal strength and surrounding objects, such as trains and transmitters.
- When the “AST” button is used, automatic station selection and automatic registering of the stations may not be possible.
- The radio antenna is mounted inside the rear quarter window. To maintain clear radio reception, do not attach metallic window tinting or other metallic objects to the antenna wire mounted inside the rear quarter window.

■ **Digital Audio Broadcast (DAB) radio**

The optional radio antenna and tuner are necessary for the use of Digital Audio Broadcast (DAB) radio.

3-2. Using the audio system

Using the CD player

Type A

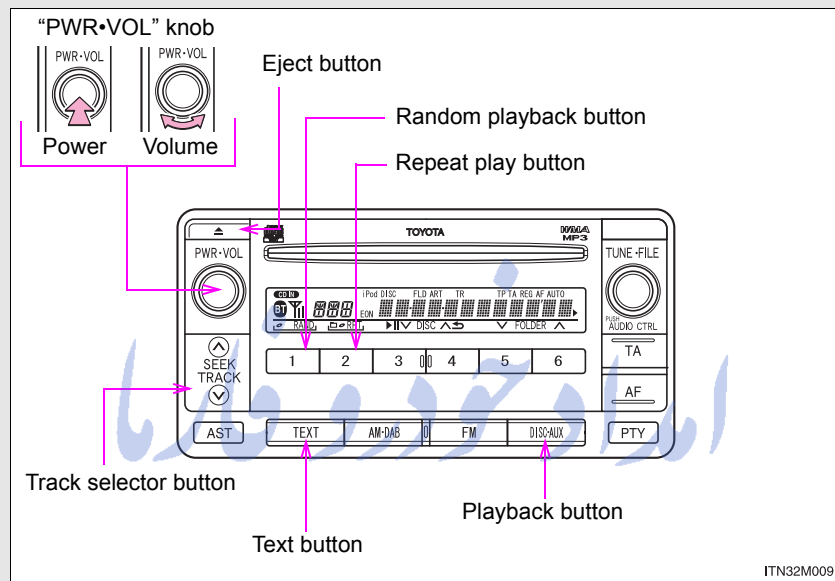

Type B

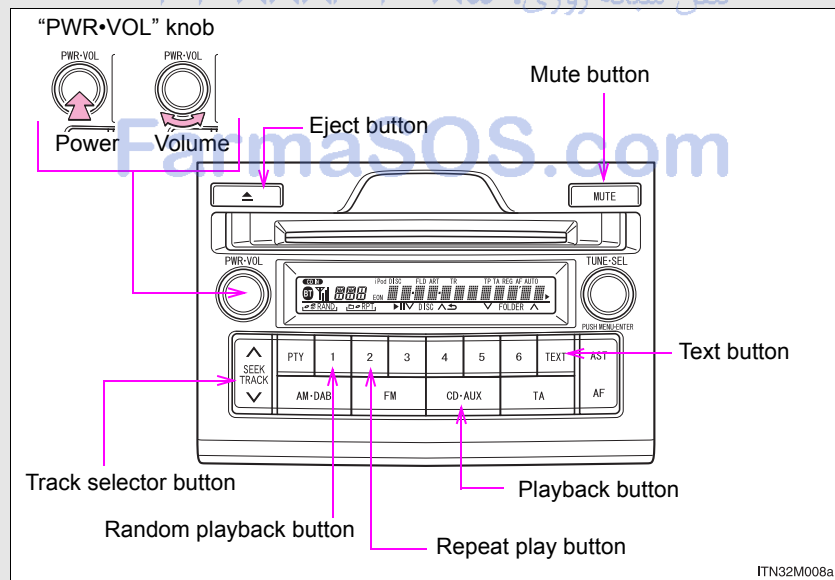

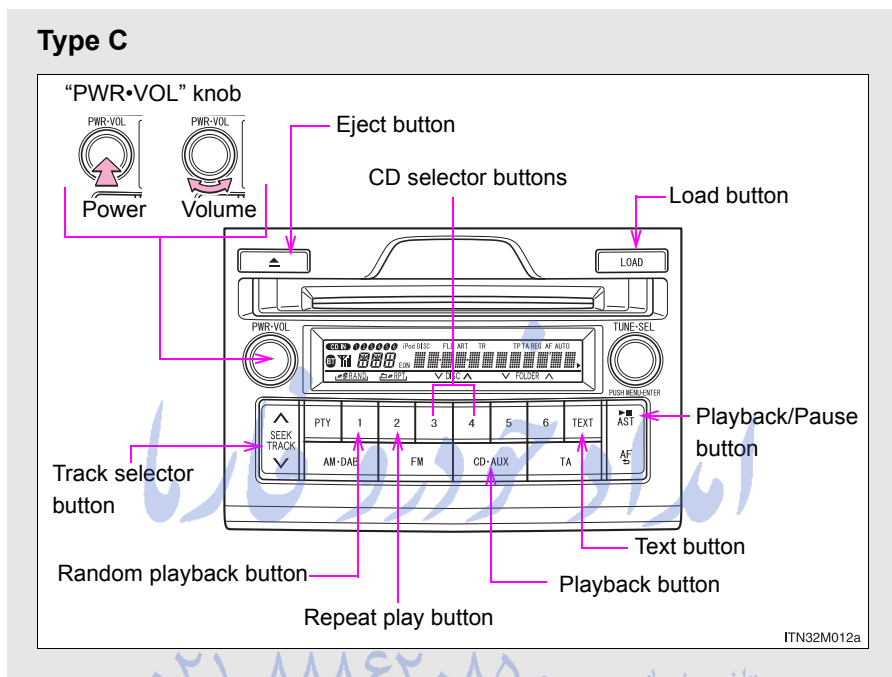

Loading a CD

■ Loading a CD

Type A and B

Insert a CD.

Type C

STEP 1 Press the “LOAD” button.

“WAIT” is shown on the display.

STEP 2 When the indicator on the slot turns from amber to green, insert a CD.

The display changes from “WAIT” to “LOAD”.

3-2. Using the audio system

■ Loading multiple CDs (type C)

STEP 1 Press and hold the “LOAD” button until you hear a beep.
“WAIT” is shown on the display.

STEP 2 When the indicator on the slot turns from amber to green,
insert a CD.

The display changes from “WAIT” to “LOAD”.

The indicator on the slot turns to amber when the CD is being
inserted.

STEP 3 When the indicator on the slot turns from amber to green,
insert the next CD.

Repeat the procedure for the remaining CDs.

To cancel the operation, press the “LOAD” button. If you do not
insert a disc within 15 seconds, loading will be canceled automati-
cally.

Ejecting CDs

■ Ejecting a CD

Type A and B

Press  and remove the CD.

FarmaSOS.com

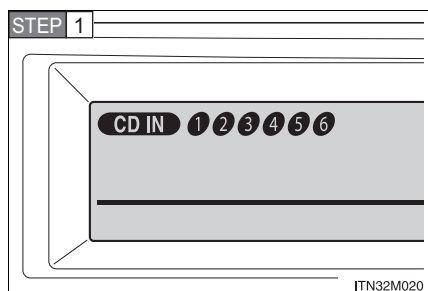
Type C

To select the CD to be ejected, press the 3 (∨) or 4 (∧) button.

The selected disc number is shown on the display.

STEP 2 Press  and remove the CD.

- **Ejecting all the CDs (type C)**

Press and hold  until you hear a beep, and then remove the CDs.

Selecting, fast-forwarding and reversing tracks

- **Selecting a track**

Press “∧” to move up or “∨” to move down using the “SEEK/ TRACK” button until the desired track number is displayed.

- **Fast-forwarding and reversing tracks**

To fast-forward or reverse, press and hold “∧” or “∨” on the “SEEK/ TRACK” button until you hear a beep.

Selecting a CD (type C)

To select the desired CD, press the 3 (v) or 4 (^) button.

Playing and pausing tracks (type C)

To play or pause a track, press the "AST" (▶||) button.

Random playback

■ Current CD

Press the 1 (RAND) button.

Songs are played in random order.

To cancel, press the 1 (RAND) button again.

■ All CDs (type C)

Press and hold the 1 (RAND) button until you hear a beep.

Tracks on all loaded CDs are played in random order.

To cancel, press the 1 (RAND) button again. تلفن شبانه روز: ۰۲۱-۸۸۸۴۸۸۸۸

FarmaSOS.com

Repeat play

■ Repeating a track

Press the 2 (RPT) button.

To cancel, press the 2 (RPT) button again.

■ Repeating all of the tracks on a CD (type C)

Press and hold the 2 (RPT) button until you hear a beep.

To cancel, press the 2 (RPT) button again.

Switching the display

Press the "TEXT" button.

Each time the button is pressed, the display changes in the following order: Elapsed time → CD title → Track title.

Silencing the sound (type B)

Press the "MUTE" button.

Press the button again to turn the system back on.

FarmaSOS.com

■ **CD player protection feature**

To protect the internal components, playback is automatically stopped when a problem is detected.

■ **Display**

Up to 12 characters can be displayed at a time.

If there are 13 or more characters, pressing and holding the “TEXT” button for 1 second or more enables to display the remaining characters.

A maximum of 24 characters can be displayed.

If the “TEXT” button is pressed for more than 1 second again or has not been operated for more than 6 seconds, the display will return to the first 12 characters.

Depending on the contents recorded, the characters may not be displayed properly or may not be displayed at all.

■ **When “ERROR” or “WAIT” is shown on the display**

“ERROR”: This indicates a trouble either in the CD or inside the player. The CD may be dirty, damaged, or inserted up-side down.

“WAIT”: This indicates that operation is stopped due to a high temperature inside the player. Wait for a while and then press the “DISC•AUX” or “CD•AUX” button. If the CD still cannot be played back, contact any authorized Toyota dealer or repairer, or another duly qualified and equipped professional.

FarmaSOS.com

■ Discs that can be used

Discs with the marks shown below can be used.
Playback may not be possible depending on recording format or disc features, or due to scratches, dirt or deterioration.



CDs with copy-protect features may not be used.

■ Lens cleaners

Do not use lens cleaners. Doing so may damage the CD player.

■ If discs are left inside the CD player or in the ejected position for extended periods of time

The discs may be damaged and may not play properly.

NOTICE

■ CDs and adapters that cannot be used

Do not use the following types of CDs, 8 cm (3 in.) CD adapters or Dual Disc.

Doing so may damage the CD player and/or the CD insert/eject function.

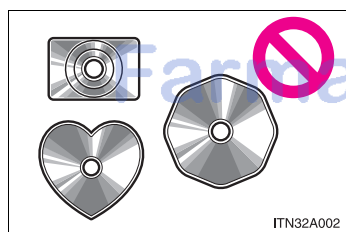

- CDs that have a diameter that is not 12 cm (4.7 in.)

3-2. Using the audio system

 NOTICE

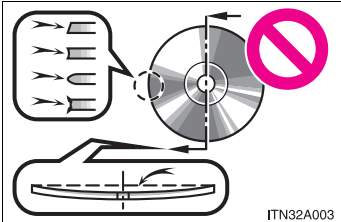

- Low-quality and deformed CDs

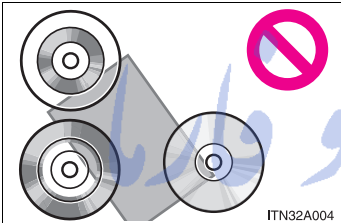

- CDs with a transparent or translucent recording area

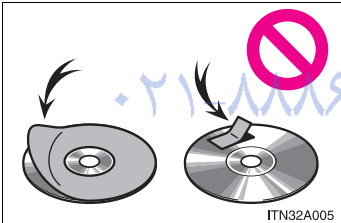

- CDs that have tape, stickers or CD-R labels attached to them, or that have had the label peeled off

امداد خودرو پارک
تلفن شبانه روزی: ۰۲۱۸۸۶۲۰۸۵
FarmaSOS.com

 NOTICE

■ **CD player precautions**

Failure to follow the precautions below may result in serious damage to the CDs or the player itself.

- Do not insert anything other than CDs into the CD slot.
- Do not apply oil to the CD player.
- Store CDs away from direct sunlight.
- Never try to disassemble any part of the CD player.
- Do not insert more than one CD at a time.

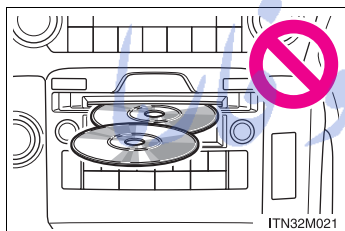

تلفن شبانه روزی: ۰۲۱-۸۸۶۲۰۸۵

FarmaSOS.com

3-2. Using the audio system

Playing MP3 and WMA discs

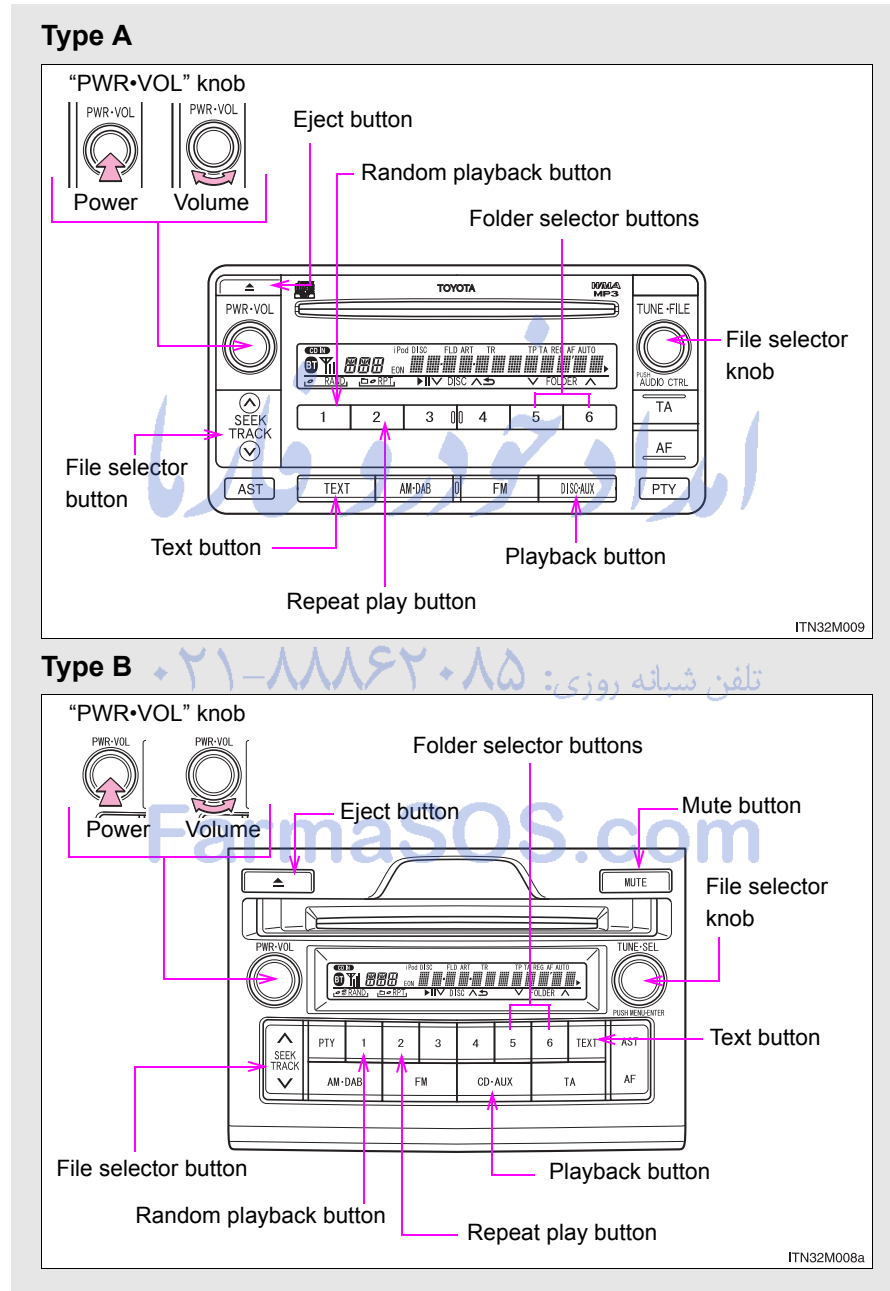

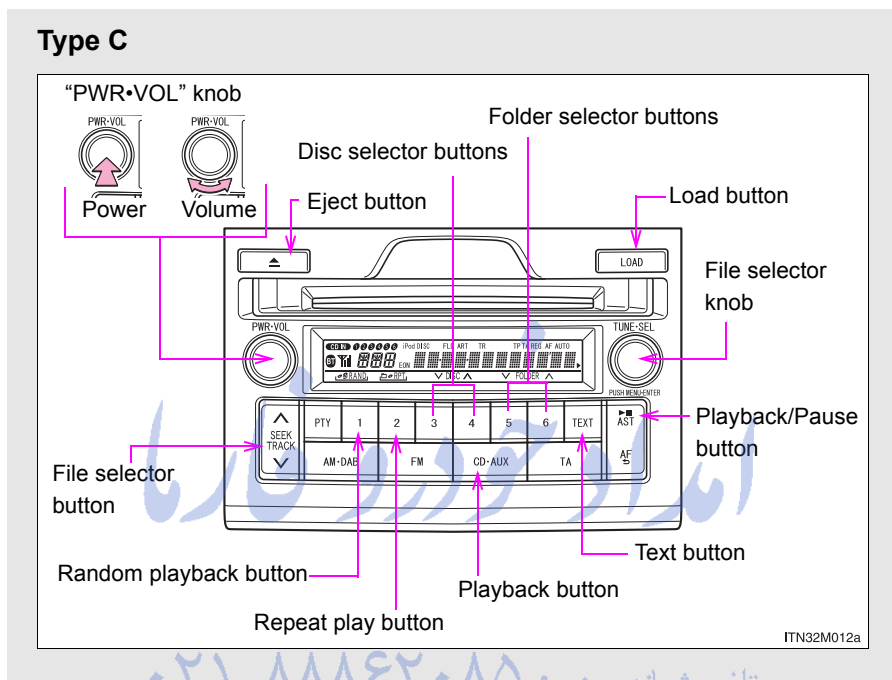

Loading and ejecting MP3 and WMA discs

→P. 459, 460

Selecting MP3 and WMA discs

→P. 462

3-2. Using the audio system

Selecting a folder

- **Selecting a folder one at a time**

Press the 6 (^) or 5 (v) button to select the desired folder.

- **Returning to the first folder**

Press and hold the 5 (v) button until you hear a beep.

Fast-forwarding and reversing files

To fast-forward or reverse, press and hold “^” or “v” on the “SEEK/TRACK” button until you hear a beep.

Selecting files

Turn the “TUNE•FILE” or “TUNE•SEL” knob or press “^” or “v” on the “SEEK/TRACK” button to select the desired file.

Playing and pausing files (type C)

To play or pause a file, press the “AST” (▶||) button.

FarmaSOS.com

Random playback

- **Playing files from a folder in random order**

Press the 1 (RAND) button.

To cancel, press the 1 (RAND) button again.

- **Playing all the files from a disc in random order**

Press and hold the 1 (RAND) button until you hear a beep.

To cancel, press the 1 (RAND) button again.

Repeat play

- **Repeating a file**

Press the 2 (RPT) button.

To cancel, press the 2 (RPT) button again.

- **Repeating all the files in a folder**

Press and hold the 2 (RPT) button until you hear a beep.

To cancel, press the 2 (RPT) button again.

FarmaSOS.com

Switching the display

Press the "TEXT" button.

Each time the button is pressed, the display changes in the following order: Folder no./File no./Elapsed time → Folder name → File name → Album title (MP3 only) → Track title → Artist name

Silencing the sound (type B)

Press the "MUTE" button.

Press the button again to turn the system back on.

■ CD player protection feature

→P. 464

■ Display

→P. 464

■ When "ERROR", "WAIT" or "NO MUSIC" is shown on the display

"ERROR": This indicates a problem either in the CD or inside the player. The CD may be dirty, damaged, or inserted up-side down.

"WAIT": This indicates that operation is stopped due to a high temperature inside the player. Wait for a while and then press the "DISC•AUX" or "CD•AUX" button. If the CD still cannot be played back, contact any authorized Toyota dealer or repairer, or another duly qualified and equipped professional.

"NO MUSIC": This indicates that an MP3/WMA file is not included in the CD.

■ **Discs that can be used**

→P. 465

■ **Lens cleaners**

→P. 465

■ **If discs are left inside the CD player or in the ejected position for extended periods of time**

→P. 465

■ **MP3 and WMA files**

MP3 (MPEG Audio LAYER3) is a standard audio compression format.

Files can be compressed to approximately 1/10 of their original size by using MP3 compression.

WMA (Windows Media Audio) is a Microsoft audio compression format.

This format compresses audio data to a size smaller than that of the MP3 format.

There is a limit to the MP3 and WMA file standards that can be used and to the media/formats on which the files are recorded.

● **MP3 file compatibility**

- Compatible standards
MP3 (MPEG1 LAYER3, MPEG2 LSF LAYER3)
- Compatible sampling frequencies
MPEG1 LAYER3: 32, 44.1, 48 (kHz)
MPEG2 LSF LAYER3: 16, 22.05, 24 (kHz)
- Compatible bit rates (compatible with VBR)
MPEG1 LAYER3: 64, 80, 96, 112, 128, 160, 192, 224, 256, 320 (kbps)
MPEG2 LSF LAYER3: 64, 80, 96, 112, 128, 144, 160 (kbps)
- Compatible channel modes: stereo, joint stereo, dual channel and monaural

3-2. Using the audio system

- WMA file compatibility
 - Compatible standards
WMA Ver. 7, 8, 9
 - Compatible sampling frequencies
32, 44.1, 48 (kHz)
 - Compatible bit rates (only compatible with 2-channel playback)
Ver. 7, 8: CBR 48, 64, 80, 96, 128, 160, 192 (kbps)
Ver. 9: CBR 48, 64, 80, 96, 128, 160, 192, 256, 320 (kbps)
- Compatible media

Media that can be used for MP3 and WMA playback are CD-Rs and CD-RWs.

Playback in some instances may not be possible if the CD-R or CD-RW is not finalized. Playback may not be possible or the audio may jump if the disc is scratched or marked with fingerprints.
- Compatible disc formats

The following disc formats can be used:

 - Disc formats: CD-ROM Mode 1 and Mode 2
CD-ROM XA Mode 2, Form 1 and Form 2
 - File formats: ISO9660 Level 1, Level 2, (Romeo, Joliet)
MP3 and WMA files written in any format other than those listed above may not play correctly, and their file names and folder names may not be displayed correctly.

Items related to standards and limitations are as follows:

 - Maximum directory hierarchy: 8 levels (including the root)
 - Maximum length of folder names/file names: 32 characters
 - Maximum number of folders: 192 (including the root)
 - Maximum number of files per disc: 255

- File names

The only files that can be recognized as MP3/WMA and played are those with the extension .mp3 or .wma.

- Discs containing multi-session recordings

As the audio system is compatible with multi-sessions, it is possible to play discs that contain MP3 and WMA files. However, only the first session can be played.

- ID3 and WMA tags

ID3 tags can be added to MP3 files, making it possible to record the track title, artist name, etc.

The system is compatible with ID3 Ver. 1.0, 1.1, and Ver. 2.2, 2.3 ID3 tags. (The number of characters is based on ID3 Ver. 1.0 and 1.1.)

WMA tags can be added to WMA files, making it possible to record the track title and artist name in the same way as with ID3 tags.

- MP3 and WMA playback

When a disc containing MP3 or WMA files is inserted, all files on the disc are first checked. Once the file check is finished, the first MP3 or WMA file is played. To make the file check finish more quickly, we recommend you do not write in any files other than MP3 or WMA files or create any unnecessary folders.

Discs that contain a mixture of music data and MP3 or WMA format data cannot be played.

FarmaSOS.com

3-2. Using the audio system

- Extensions

If the file extensions .mp3 and .wma are used for files other than MP3 and WMA files, they will be mistakenly recognized and played as MP3 and WMA files. This may result in large amounts of interference and damage to the speakers.

- Playback

- To play MP3 file with steady sound quality, we recommend a fixed bit rate of least 128 kbps and a sampling frequency of 44.1 kHz.
- CD-R or CD-RW playback may not be possible in some instances, depending on the characteristics of the disc.
- There is a wide variety of freeware and other encoding software for MP3 and WMA files on the market, and depending on the status of the encoding and the file format, poor sound quality or noise at the start of playback may result. In some cases, playback may not be possible at all.
- When files other than MP3 or WMA files are recorded on a disc, it may take more time to recognize the disc and in some cases, playback may not be possible at all.
- Microsoft, Windows, and Windows Media are the registered trademarks of Microsoft Corporation in the U.S.A. and other countries.



NOTICE

- **CDs and adapters that cannot be used**

→P. 465

- **CD player precautions**

→P. 467

3-2. Using the audio system Operating an iPod*

Connecting an iPod enables you to enjoy music from the vehicle speakers.

■ Connecting an iPod

STEP 1 Open the cover and connect an iPod using an iPod cable.

Turn on the power of the iPod if it is not turned on.

Vehicles with an automatic transmission

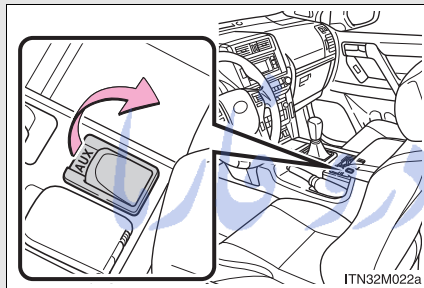

Vehicles with a manual transmission

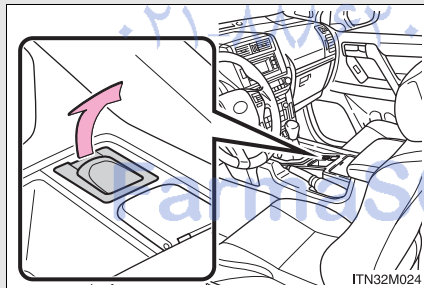

STEP 2 Press the “DISC•AUX” or “CD•AUX” button.

*: If equipped

3-2. Using the audio system

■ Control panel

Type A

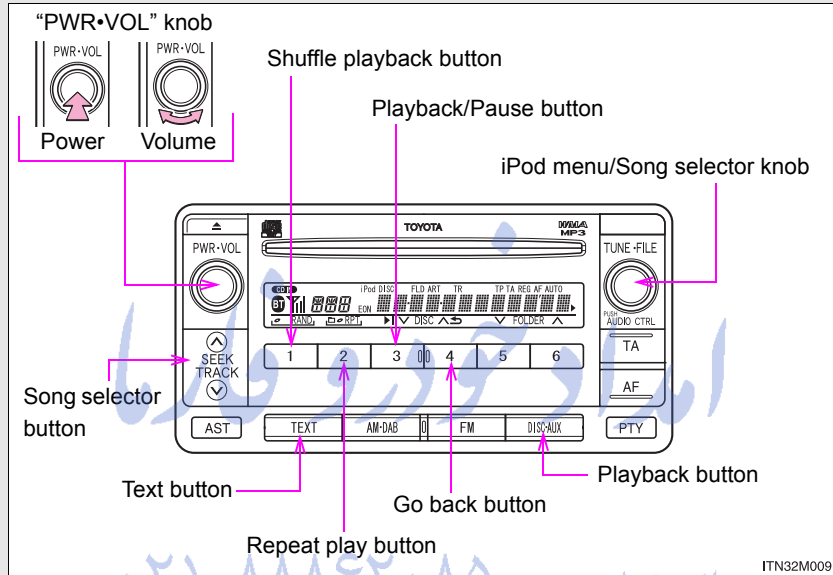

Type B

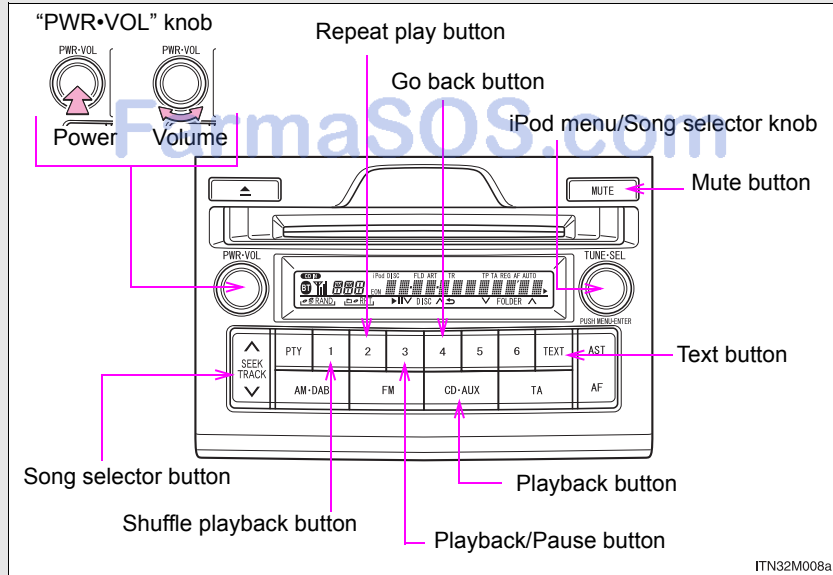

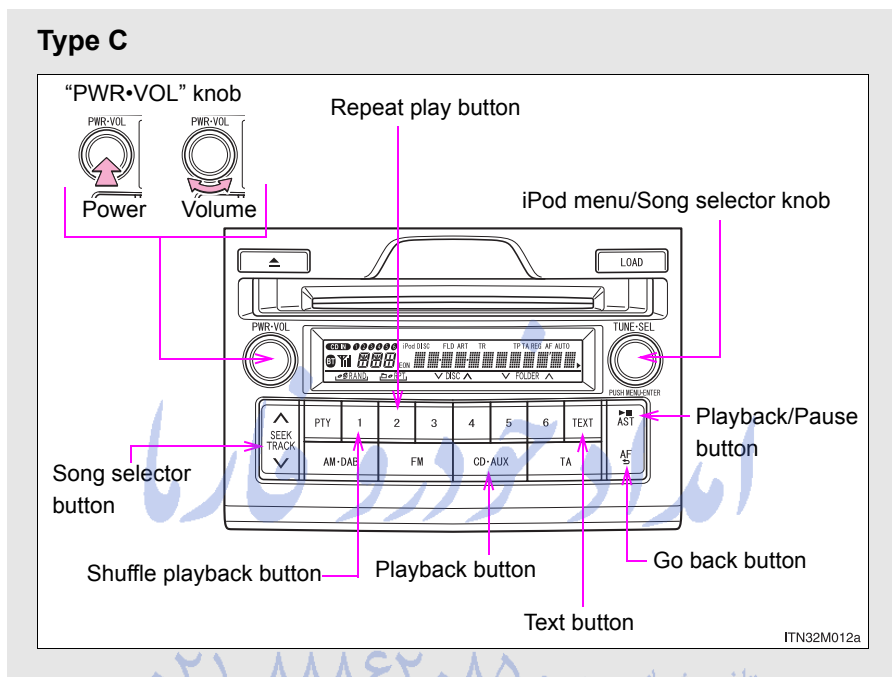

Selecting a play mode

- STEP 1** Press the “TUNE•FILE” or “TUNE•SEL” knob to select iPod menu mode.
- STEP 2** Turning the “TUNE•FILE” or “TUNE•SEL” knob changes the play mode in the following order:
 “PLAYLISTS” → “ARTISTS” → “ALBUMS” → “SONGS” →
 “PODCASTS” → “GENRES” → “COMPOSERS” →
 “AUDIOBOOKS”
- STEP 3** Press the “TUNE•FILE” or “TUNE•SEL” knob to select the desired play mode.

■ **Play mode list**

Play mode	First selection	Second selection	Third selection	Fourth selection
“PLAYLISTS”	Playlists select	Songs select	-	-
“ARTISTS”	Artists select	Albums select	Songs select	-
“ALBUMS”	Albums select	Songs select	-	-
“SONGS”	Songs select	-	-	-
“PODCASTS”	Albums select	Songs select	-	-
“GENRES”	Genre select	Artists select	Albums select	Songs select
“COMPOSERS”	Composers select	Albums select	Songs select	-
“AUDIO-BOOKS”	Songs select	-	-	-

■ **Selecting a list**

STEP 1 Turn the “TUNE•FILE” or “TUNE•SEL” knob to display the first selection list.

STEP 2 Press the “TUNE•FILE” or “TUNE•SEL” knob to select the desired item.
Pressing the knob changes to the second selection list.

STEP 3 Repeat the same procedure to select the desired song name.
To return to the previous selection list, select “GO BACK” or press the 4 (↵) or “AF” (↵) button.

Selecting songs

Turn the “TUNE•FILE” or “TUNE•SEL” knob or press “^” or “v” on the “SEEK/TRACK” button to select the desired song.

Playing and pausing songs

To play or pause a song, press the 3 (▶||) or “AST” (▶||) button.

Fast-forwarding and rewinding songs

To fast-forward or rewind, press and hold “^” or “v” on the “SEEK/TRACK” button until you hear a beep.

Shuffle playback

■ Playing songs from one playlist or album in random order

Press the 1 (RAND) button.

To cancel, press the 1 (RAND) button again.

■ Playing songs from all the playlists or albums in random order

Press and hold the 1 (RAND) button until you hear a beep.

To cancel, press the 1 (RAND) button again.

3-2. Using the audio system

Repeat play

Press the 2 (RPT) button.

To cancel, press the 2 (RPT) button again.

Switching the display

Press the "TEXT" button.

Each time the button is pressed, the display changes in the following order: Elapsed time → Album title → Track title → Artist name

Silencing the sound (type B)

Press the "MUTE" button.

Press the button again to turn the system back on.

Adjusting sound quality and volume balance

STEP 1 Press the "TUNE•FILE" or "TUNE•SEL" knob to enter iPod menu mode.

STEP 2 Pressing the "TUNE•FILE" or "TUNE•SEL" knob changes sound modes. (→P. 496)

■ About iPod

- Apple is not responsible for the operation of this device or its compliance with safety and regulatory standards.
- iPod is a trade mark of Apple inc., registered in the U.S. and other countries.

■ iPod functions

- When an iPod is connected and the audio source is changed to iPod mode, the iPod will resume play from the same point in which it was last used.
- Depending on the iPod that is connected to the system, certain functions may not be available. Disconnecting the device and reconnecting it once again may resolve some malfunctions.

■ iPod problems

To resolve most problems encountered when using your iPod, disconnect your iPod from the vehicle iPod connection and reset it. For instructions on how to reset your iPod, refer to your iPod Owner's Manual.

■ Display

→P. 464

■ Error messages

- “ERROR”: This indicates a problem in the iPod or its connection.
- “NO MUSIC”: This indicates that there is no music data in the iPod.
- “EMPTY”: This indicates that an empty playlist is selected.
- “UPDATE”: This indicates that the version of the iPod is not compatible. Upgrade your iPod software to the latest version.

3-2. Using the audio system

■ Compatible models

Model	Generation	Software version
iPod	5th generation	Ver. 1.2.0 or higher
iPod nano	1st generation	Ver. 1.3.0 or higher
	2nd generation	Ver. 1.1.2 or higher
	3rd generation	Ver. 1.0.0 or higher
iPod touch	1st generation	Ver. 1.1.0 or higher
iPod classic	1st generation	Ver. 1.0.0 or higher

Depending on differences between models or software version etc., some models listed above might be incompatible with this system.

iPod 4th generation and earlier models are not compatible with this system.
iPhone, iPod mini, iPod shuffle and iPod photo are not compatible with this system.

Items related to standards and limitations are as follows:

- Maximum number of lists in device: 9999
- Maximum number of songs in device: 65535
- Maximum number of songs per list: 65535

FarmaSOS.com

 CAUTION

■ **Caution while driving**

Do not connect iPod or operate the controls.

 NOTICE

■ **To prevent damage to iPod**

- Do not leave iPod in the vehicle. The temperature inside the vehicle may become high, resulting in damage to the player.
- Do not push down on or apply unnecessary pressure to the iPod while it is connected as this may damage the iPod or its terminal.
- Do not insert foreign objects into the port as this may damage the iPod or its terminal.

تلفن شبانه روزی: ۰۲۱-۸۸۶۲۰۸۵

FarmaSOS.com

3-2. Using the audio system

Operating a USB memory*

Connecting a USB memory enables you to enjoy music from the vehicle speakers.

■ Connecting a USB memory

STEP 1 Open the cover and connect a USB memory.

Turn on the power of the USB memory if it is not turned on.

Vehicles with an automatic transmission

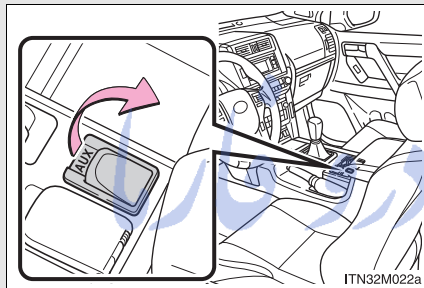

Vehicles with a manual transmission

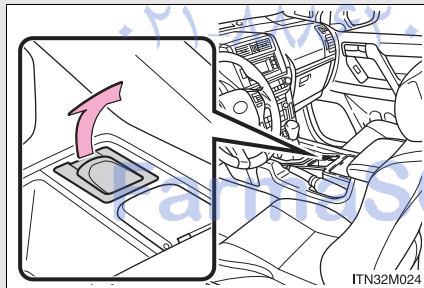

STEP 2 Press the “DISC•AUX” or “CD•AUX” button.

*: If equipped

■ Control panel

Type A

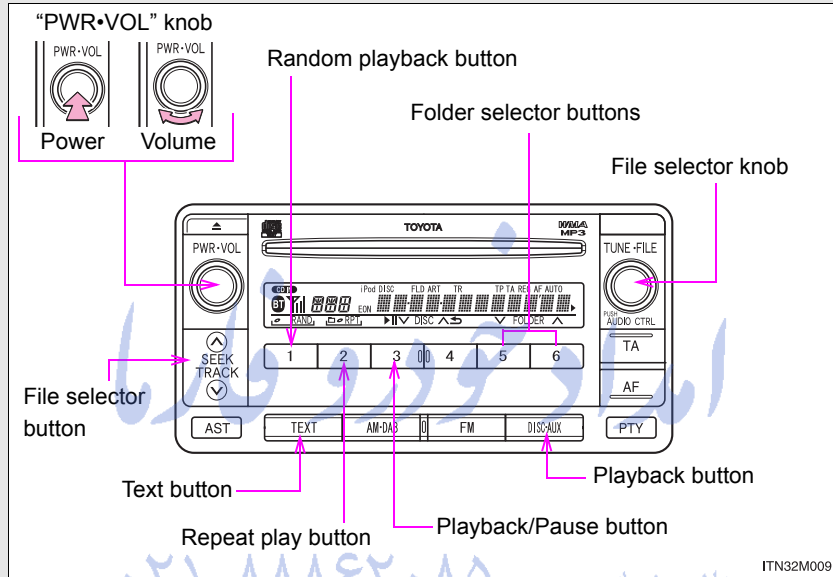

ITN32M009

Type B

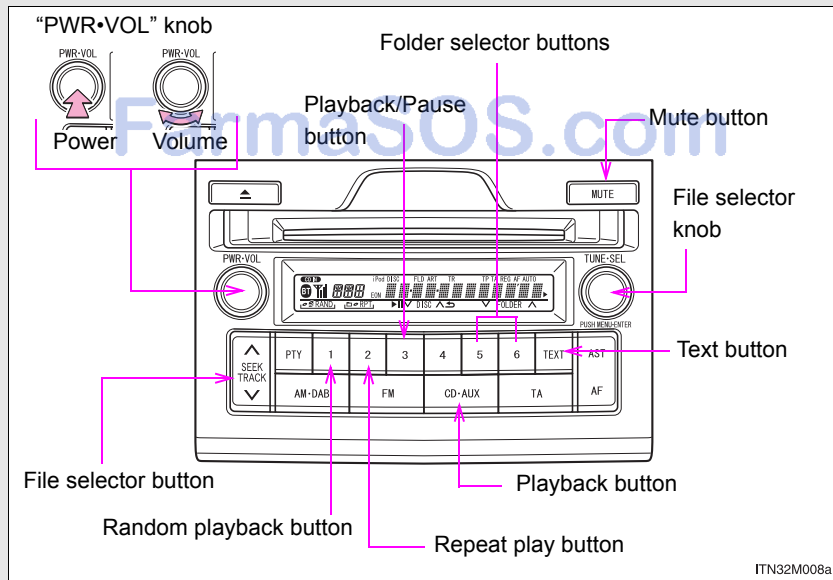

ITN32M008a

3-2. Using the audio system

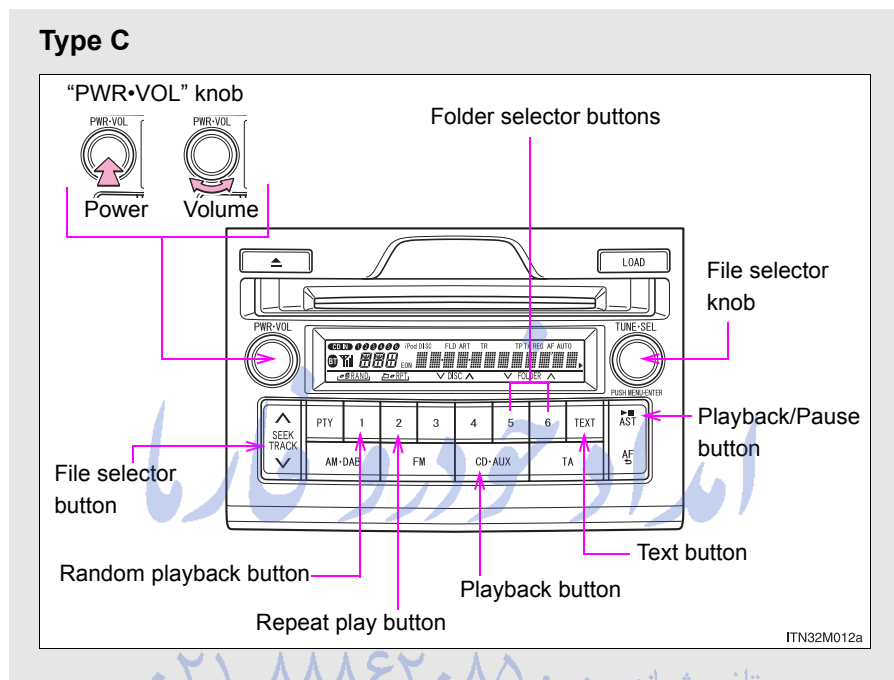

Selecting a folder

- **Selecting folders one at a time**
Press the 6 (^) or 5 (v) button to select the desired folder.
- **Returning to the first folder**
Press and hold the 5 (v) button until you hear a beep.

Selecting files

Turn the “TUNE•FILE” or “TUNE•SEL” knob or press “^” or “v” on the “SEEK/TRACK” button to select the desired file.

Playing and pausing files

To play or pause a file, press the 3 (▶||) or “AST” (▶||) button.

Fast-forwarding and rewinding files

To fast-forward or rewind, press and hold “^” or “v” on the “SEEK/TRACK” button until you hear a beep.

Random playback

- **Playing files from a folder in random order**

Press the 1 (RAND) button.

To cancel, press the 1 (RAND) button again.

- **Playing all the files from a USB memory in random order**

Press and hold the 1 (RAND) button until you hear a beep.

To cancel, press the 1 (RAND) button again.

Repeat play

■ Repeating a file

Press the 2 (RPT) button.

To cancel, press the 2 (RPT) button again.

■ Repeating all the files in a folder

Press and hold the 2 (RPT) button until you hear a beep.

To cancel, press the 2 (RPT) button again.

Switching the display

Press the "TEXT" button.

Each time the button is pressed, the display changes in the following order: Elapsed time → Folder name → File name → Album title (MP3 only) → Track title → Artist name

Silencing the sound (type B)

Press the "MUTE" button.

Press the button again to turn the system back on.

FarmaSOS.com

■ **USB memory functions**

Depending on the USB memory that is connected to the system, certain functions may not be available. Disconnecting the device and reconnecting it once again may resolve some malfunctions.

■ **Display**

→P. 464

■ **Error messages**

“ERROR”: This indicates a problem in the USB memory or its connection.

“NO MUSIC”: This indicates that no MP3/WMA files are included in the USB memory.

امداد خودرو فارما

تلفن شبانه روزی: ۰۲۱-۸۸۶۲۰۸۵

FarmaSOS.com

■ **USB memory**

- Compatible devices

USB memory that can be used for MP3 and WMA playback

- Compatible device formats

The following device formats can be used:

- USB communication formats: USB2.0 FS (12mbps)
- File formats: FAT16/32 (Windows)
- Correspondence class: Mass storage class

MP3 and WMA files written in any format other than those listed above may not play correctly, and their file names and folder names may not be displayed correctly.

Items related to standards and limitations are as follows:

- Maximum directory hierarchy: 8 levels
- Maximum number of folders in a device: 999 (including the root)
- Maximum number of files in a device: 65025
- Maximum number of files per folder: 255

- MP3 and WMA files

MP3 (MPEG Audio LAYER 3) is a standard audio compression format.

Files can be compressed to approximately 1/10 of their original size using MP3 compression.

WMA (Windows Media Audio) is a Microsoft audio compression format.

This format compresses audio data to a size smaller than that of the MP3 format.

There is a limit to the MP3 and WMA file standards that can be used and to the media/formats on which the files are recorded.

- MP3 file compatibility
 - Compatible standards
MP3 (MPEG1 AUDIO LAYERII, III, MPEG2 AUDIO LAYERII, III, MPEG2.5)
 - Compatible sampling frequencies
MPEG1 AUDIO LAYERII, III: 32, 44.1, 48 (kHz)
MPEG2 AUDIO LAYERII, III: 16, 22.05, 24 (kHz)
MPEG2.5: 8, 11.025, 12 (kHz)
 - Compatible bit rates (compatible with VBR)
MPEG1 AUDIO LAYERII, III: 32-320 (kbps)
MPEG2 AUDIO LAYERII, III: 32-160 (kbps)
MPEG2.5: 32-160 (kbps)
 - Compatible channel modes: stereo, joint stereo, dual channel and monaural
- WMA file compatibility
 - Compatible standards
WMA Ver. 9
 - Compatible sampling frequencies
HIGH PROFILE 32, 44.1, 48 (kHz)
 - Compatible bit rates
HIGH PROFILE 32-320 (kbps, VBR)
- File names
The only files that can be recognized as MP3/WMA and played are those with the extension .mp3 or .wma.

FarmaSOS.com

3-2. Using the audio system

- ID3 and WMA tags

ID3 tags can be added to MP3 files, making it possible to record the track title, artist name, etc.

The system is compatible with ID3 Ver. 1.0, 1.1, and Ver. 2.2, 2.3, 2.4 ID3 tags. (The number of characters is based on ID3 Ver. 1.0 and 1.1.)

WMA tags can be added to WMA files, making it possible to record the track title and artist name in the same way as with ID3 tags.

- MP3 and WMA playback

- When a device containing MP3 or WMA files is connected, all files in the USB memory device are checked. Once the file check is finished, the first MP3 or WMA file is played. To make the file check finish more quickly, we recommend that you do not include any files other than MP3 or WMA files or create any unnecessary folders.

- When the USB device is connected and the audio source is changed to USB memory mode, the USB device will start playing the first file in the first folder. If the same device is removed and reinserted (and the contents have not been changed), the USB device will resume play from the same point in which it was last used.

- Extensions

If the file extensions .mp3 and .wma are used for files other than MP3 and WMA files, they will be mistakenly recognized and played as MP3 and WMA files. This may result in large amounts of interference and damage to the speakers.

FarmaSOS.com

- Playback

- To play MP3 files with steady sound quality, we recommend a fixed bit rate of at least 128 kbps and a sampling frequency of 44.1 kHz.
- There is a wide variety of freeware and other encoding software for MP3 and WMA files on the market, and depending on the status of the encoding and the file format, poor sound quality or noise at the start of playback may result. In some cases, playback may not be possible at all.
- Microsoft, Windows, and Windows Media are registered trademarks of Microsoft Corporation in the U.S.A. and other countries.

 **CAUTION**

■ **Caution while driving**

Do not connect USB memory or operate the controls.

 **NOTICE**

■ **To prevent damage to USB memory**

- Do not leave USB memory in the vehicle. The temperature inside the vehicle may become high, resulting in damage to the player.
- Do not push down on or apply unnecessary pressure to the USB memory while it is connected as this may damage the USB memory or its terminal.
- Do not insert foreign objects into the port as this may damage the USB memory or its terminal.

3-2. Using the audio system

Optimal use of the audio system

Type A

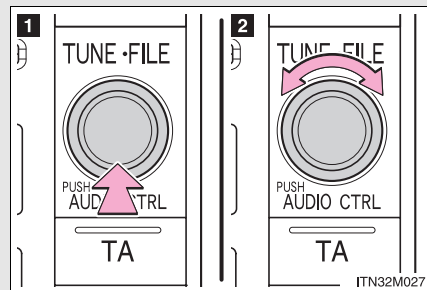

- 1 Displays the current mode
- 2 Changes the following settings

- Sound quality and volume balance
→P. 496

The sound quality and balance setting can be changed to produce the best sound.

- Automatic Sound Levelizer on/off
→P. 498

Type B and C

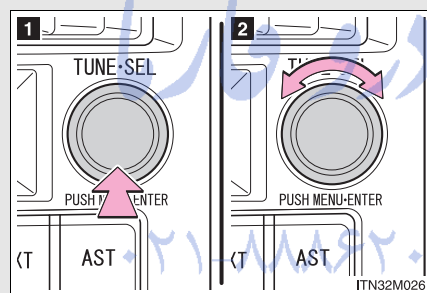

Adjusting sound quality and volume balance

■ Changing sound quality modes

Pressing the “TUNE•FILE” or “TUNE•SEL” knob.

Pressing the button changes sound modes in the following order:

“BAS” → “MID” (type C) → “TRE” → “FAD” → “BAL” → “ASL”

■ Adjusting sound quality

Turning the “TUNE•FILE” or “TUNE•SEL” knob adjusts the level.

Mode displayed	Sound quality mode	Level	Turn counterclockwise	Turn clockwise
“BAS”	Bass* ²	-5 to 5	Low	High
“MID”* ¹	Mid-range* ²	-5 to 5		
“TRE”	Treble* ²	-5 to 5		
“FAD”	Front/rear volume balance	F7 to R7	Shifts to rear	Shifts to front
“BAL”	Left/right volume balance	L7 to R7	Shifts to left	Shifts to right

*1: If equipped

*2: The sound quality level is adjusted individually in each audio mode.

تلفن شبانه روزی: ۰۲۱-۸۸۶۲۰۸۵

FarmaSOS.com

Turning the Automatic Sound Levelizer (ASL) on/off

Type A and B

When “ASL” is selected, turning the “TUNE•FILE” or “TUNE•SEL” knob to the right changes the “ASL” level in the order of “LOW”, “MID” and “HIGH”.

Turning the “TUNE•FILE” or “TUNE•SEL” knob to the left turns “ASL” off.

ASL automatically adjusts the volume and tone quality according to the vehicle speed.

Type C

Turning the “TUNE•FILE” or “TUNE•SEL” knob clockwise turns on the ASL, and turning the “TUNE•FILE” or “TUNE•SEL” knob counterclockwise turns off the ASL.

ASL automatically adjusts the volume and tone quality according to the noise level as you drive your vehicle.

■ Trademark owned by SRS Labs, Inc. (type A and B)



The audio systems utilize SRS FOCUS[®] and SRS TruBass[®] audio enhancement technologies, under license from SRS Labs, Inc., in all mode except AM radio mode.

FOCUS, TruBass, SRS and  symbols are trademarks of SRS Labs, Inc.

FOCUS and TruBass technologies are incorporated under license from SRS Labs, Inc.

3-2. Using the audio system Using the AUX port*

This port can be used to connect a portable audio device and listen to it through the vehicle's speakers.

STEP 1 Open the cover and connect the portable audio device.

Vehicles with an automatic transmission

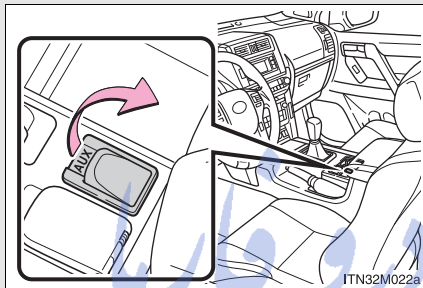

Vehicles with a manual transmission

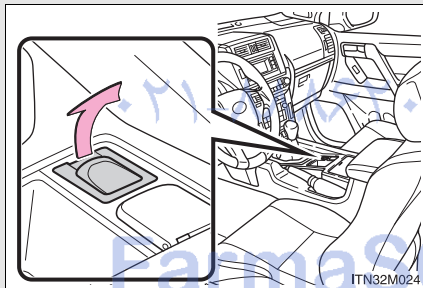

STEP 2 Press the "DISC•AUX" or "CD•AUX" button.

*: If equipped

■ **Operating portable audio devices connected to the audio system**

The volume can be adjusted using the vehicle's audio controls. All the other adjustments must be made on the portable audio device itself.

■ **When using a portable audio device connected to the power outlet**

Noise may occur during playback. Use the power source of the portable audio device.

امداد خودرو فارما

تلفن شبانه روزی: ۰۸۵-۸۸۸۶۲۰۲۱

FarmaSOS.com

3-2. Using the audio system

Using the steering wheel audio switches*

Some audio features can be controlled using the switches on the steering wheel.

Operation may differ depending on the type of audio system or navigation system. For details, refer to the manual provided with the audio system or navigation system.

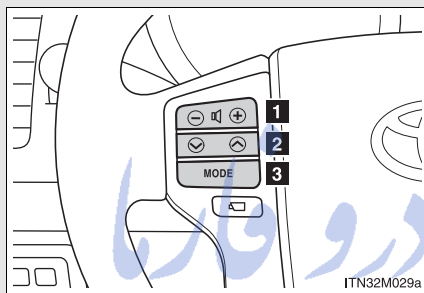

1 Increases/decreases volume

2 Radio mode: Selects a radio station

CD mode: Selects a track, file (MP3 and WMA) and disc

Bluetooth® audio mode: Selects a track and album

iPod mode: Selects a song

USB memory mode: Selects a file and folder

3 Turns the power on, selects an audio source

3

Interior features

Turning the power on

Press the “MODE” button when the audio system is turned off.

The audio system can be turned off by holding the switch down for 1 second or more.

*: If equipped

3-2. Using the audio system

Changing the audio source

Press the “MODE” button when the audio system is turned on. The audio source changes as follows each time the button is pressed. If no discs are inserted in the player, that mode will be skipped.

FM1 → FM2 → FM3 → CD player → Bluetooth® audio → AUX → iPod or USB memory → MW → DAB (if equipped) → FM1

Adjusting the volume

Press “+” on  to increase the volume and “-” to decrease the volume.

Hold down the button to continue increasing or decreasing the volume.

Selecting a radio station

STEP 1 Press the “MODE” button to select the radio mode.

STEP 2 Press “^” or “v” on  to select a radio station.

To scan for receivable stations, press and hold “^” or “v” the button until you hear a beep.

Selecting a track/file or song

STEP 1 Press the “MODE” button to select CD, Bluetooth® audio, iPod or USB memory mode.

STEP 2 Press “^” or “v” on  to select the desired track/file or song.

Selecting an album

STEP 1 Press the “MODE” button to select Bluetooth® audio mode.

STEP 2 Press and hold “^” or “v” on  until you hear a beep.

Selecting a folder

STEP 1 Press the “MODE” button to select USB memory mode.

STEP 2 Press and hold “^” or “v” on  until you hear a beep.

Selecting a disc in the CD player

STEP 1 Press the “MODE” button to select CD mode.

STEP 2 Press and hold “^” or “v” on  until you hear a beep.

■ Canceling automatic selection of a radio station

Press  again.

⚠ CAUTION

■ To reduce the risk of an accident

Exercise care when operating the audio switches on the steering wheel.

3-3. Using the Bluetooth® audio system Bluetooth® audio system*

The Bluetooth® audio system enables you to enjoy music played on a portable player from the vehicle speakers via wireless communication.

This audio system supports Bluetooth®, a wireless data system capable of playing portable audio music without cables. If your portable player does not support Bluetooth®, the Bluetooth® audio system will not function.

Vehicles with a navigation system

Refer to the “Navigation System Owner’s Manual”.

Vehicles without a navigation system

Title	Page
Using the Bluetooth® audio system	P. 511
Operating a Bluetooth® enabled portable player	P. 514
Setting up a Bluetooth® enabled portable player	P. 518
Bluetooth® audio system setup	P. 522

FarmaSOS.com

*: If equipped

■ **Conditions under which the system will not operate**

- If using a portable player that does not support Bluetooth®
- If the portable player is switched off
- If the portable player is not connected
- If the portable player's battery is low
- If the portable player is behind the seat or in the glove box or console box
- If metal is covering or touching the player

■ **When transferring ownership of the vehicle**

Be sure to initialize the system to prevent personal data from being improperly accessed. (→ P. 549)

■ **About Bluetooth®**



Bluetooth is a registered trademark of Bluetooth SIG, Inc.

■ **Compatible models**

- Bluetooth® specifications:
Ver. 1.2, or higher (Recommended: Ver. 2.0+EDR or higher)
- Following Profiles:
 - A2DP (Advanced Audio Distribution Profile) Ver. 1.0 or higher
 - AVRCP (Audio/Video Remote Control Profile) Ver. 1.0 or higher (Ver. 1.3 or higher recommended)

Portable players must correspond to the above specifications in order to be connected to the Bluetooth® audio system. However, please note that some functions may be limited depending on the type of portable player.

3-3. Using the Bluetooth® audio system

■ Certification for the Bluetooth® audio system

Pioneer



Manufacturer's Declaration of Conformity

Manufacturer: Pioneer Corporation
4-1, 1-Chome, Meguro, Meguro-Ku
TOKYO, 153 - 8654, JAPAN

EU Representative: Pioneer Europe NV
Haven 1087, Keetberglaan 1
9120 MELSELE, BELGIUM

The EU Directives covered by this Declaration

1999/5/EC R&TTE Directive of the European Parliament and of the Council

2006/95/EC Low Voltage Directive

The product covered by this declaration

CD RDS Receiver Head Unit

model **DEX-MG4397**

The basis on which conformity is being declared

The product identified above complies with the requirements of the Low Voltage Directive and the R&TTE Directive above by meeting following standards:
EN300328 V1.7.1 : 2006, EN301489-1 V1.6.1 : 2005, EN301489-17 V1.2.1 : 2002, ISO7637-2:2004 and EN60065:2002 + A1 : 2006

The technical documentation required to demonstrate that the product meets the requirements of the LVD and R&TTE has been compiled by the signatory below and is available for inspection by the relevant enforcement authorities.

A sample of the product has been tested by the manufacturer.

Technical File No: KCE08-003C

The CE mark was first applied in: 2009

Done at Melsele

05/03/2009

Ivan Vlietinck

Manager Public Affairs

PIONEER EUROPE NV
Haven 1087 - Keetberglaan 1 - 9120 Melsele - Belgium
Telefoon +32 (0)3 570 05 11 - Fax +32 (0)3 570 08 86 - URL <http://www.pioneer-eur.com> - BTW BE 406.999.132 - RPR Dendermonde



FUJITSU TEN LIMITED
 Engineering Management Department
 Research & Development Group
 2-28, Goshō-dori 1-chome, Hyogo-ku, Kobe, 652-8510, Japan
 Tel.: +81.78-682-2031 Fax.: +81.78-671-7160

DECLARATION of CONFORMITY

We, FUJITSU TEN LIMITED of the above address, hereby declare, at our sole responsibility, that the following product conforms to the Essential Requirements of the Radio and Telecommunications Terminal Equipment Directive 1999/5/EC in accordance with the tests conducted to the appropriate requirements of the relevant standards, as listed herewith.

Product: COMB PLAYER A
Model/ Type Number: FT0001a
Directive and Standards used:

<u>Radio :</u>	EN300 328	V1.7.1(2006-10)
<u>EMC :</u>	EN301 489-1	V1.6.1(2005-09)
	EN301 489-17	V1.2.1(2002-08)
<u>Safety :</u>	EN60065	(2002)

Supplementary Information:

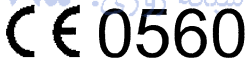
CE Mark	
Member states intend for use	EU and EFTA
Member states with restrictive use	None

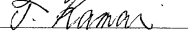
Signature: 
 Takao KAMAI
 Position: Department General Manager
 Engineering Management Department
 Research & Development Group
 Date of issue: 14 July 2008
 Place of issue: Kobe, Japan

3

Interior features

3-3. Using the Bluetooth® audio system

<p>FUJITSU TEN LIMITED tímto prohlašuje, že tento FT0001a je ve shodě se základními požadavky a dalšími příslušnými ustanoveními směrnice 1999/5/ES.</p>
<p>Undertegnede FUJITSU TEN LIMITED erklærer herved, at følgende udstyr FT0001a overholder de væsentlige krav og øvrige relevante krav i direktiv 1999/5/EF.</p>
<p>Hiermit erklärt FUJITSU TEN LIMITED, dass sich das Gerät FT0001a in Übereinstimmung mit den grundlegenden Anforderungen und den übrigen einschlägigen Bestimmungen der Richtlinie 1999/5/EG befindet.</p>
<p>Käesolevaga kinnitab FUJITSU TEN LIMITED seadme FT0001a vastavust direktiivi 1999/5/EÜ põhinõuetele ja nimetatud direktiivist tulenevatele teistele asjakohastele sätetele.</p>
<p>Hereby, FUJITSU TEN LIMITED, declares that this FT0001a is in compliance with the essential requirements and other relevant provisions of Directive 1999/5/EC.</p>
<p>Por medio de la presente FUJITSU TEN LIMITED declara que el FT0001a cumple con los requisitos esenciales y cualesquiera otras disposiciones aplicables o exigibles de la Directiva 1999/5/CE.</p>
<p>ΜΕ ΤΗΝ ΠΑΡΟΥΣΑ FUJITSU TEN LIMITED ΔΗΛΩΝΕΙ ΟΤΙ FT0001a ΣΥΜΜΟΡΦΩΝΕΤΑΙ ΠΡΟΣ ΤΙΣ ΟΥΣΙΩΔΕΙΣ ΑΠΑΙΤΗΣΕΙΣ ΚΑΙ ΤΙΣ ΛΟΙΠΕΣ ΣΧΕΤΙΚΕΣ ΔΙΑΤΑΞΕΙΣ ΤΗΣ ΟΔΗΓΙΑΣ 1999/5/EK.</p>
<p>Par la présente FUJITSU TEN LIMITED déclare que l'appareil FT0001a est conforme aux exigences essentielles et aux autres dispositions pertinentes de la directive 1999/5/CE.</p>
<p>Con la presente FUJITSU TEN LIMITED dichiara che questo FT0001a è conforme ai requisiti essenziali ed alle altre disposizioni pertinenti stabilite dalla direttiva 1999/5/CE.</p>
<p>Ar šo FUJITSU TEN LIMITED deklarē, ka FT0001a atbilst Direktīvas 1999/5/EK būtiskajām prasībām un citiem ar to saistītajiem noteikumiem.</p>
<p>Šiuo FUJITSU TEN LIMITED deklaruoja, kad šis FT0001a atitinka esminius reikalavimus ir kitas 1999/5/EB Direktyvos nuostatas.</p>

3-3. Using the Bluetooth® audio system

Hierbij verklaart FUJITSU TEN LIMITED dat het toestel FT0001a in overeenstemming is met de essentiële eisen en de andere relevante bepalingen van richtlijn 1999/5/EG.
Hawnhekk, FUJITSU TEN LIMITED, jiddikjara li dan FT0001a jikkonforma mal-htigijiet essenzjali u ma provvedimenti oħrajn relevanti li hemm fid-Dirrettiva 1999/5/EC.
Alulírott, FUJITSU TEN LIMITED nyilatkozom, hogy a FT0001a megfelel a vonatkozó alapvető követelményeknek és az 1999/5/EC irányelv egyéb előírásainak.
Niniejszym FUJITSU TEN LIMITED oświadcza, że FT0001a jest zgodny z zasadniczymi wymogami oraz pozostałymi stosownymi postanowieniami Dyrektywy 1999/5/EC.
FUJITSU TEN LIMITED declara que este FT0001a está conforme com os requisitos essenciais e outras disposições da Directiva 1999/5/CE.
FUJITSU TEN LIMITED izjavlja, da je ta FT0001a v skladu z bistvenimi zahtevami in ostalimi relevantnimi določili direktive 1999/5/ES.
FUJITSU TEN LIMITED týmto vyhlasuje, že FT0001a splňa základné požiadavky a všetky príslušné ustanovenia Smernice 1999/5/ES.
FUJITSU TEN LIMITED vakuuttaa täten että FT0001a tyyppinen laite on direktiivin 1999/5/EY oleellisten vaatimusten ja sitä koskevien direktiivin muiden ehtojen mukainen.
Härmed intygar FUJITSU TEN LIMITED att denna FT0001a står i överensstämmelse med de väsentliga egenskapskrav och övriga relevanta bestämmelser som framgår av direktiv 1999/5/EG.
Hér með lýsir FUJITSU TEN LIMITED yfir því að FT0001a er í samræmi við grunnkröfur og aðrar kröfur, sem gerðar eru í tilskipun 1999/5/EC.
FUJITSU TEN LIMITED erklærer herved at udsyret FT0001a er i samsvar med de grundlæggende krav og øvrige relevante krav i direktiv 1999/5/EF.

3

Interior features

 CAUTION

■ **Caution while driving**

Do not connect portable players or operate the controls.

■ **Caution regarding interference with electronic devices**

- Your audio unit is fitted with Bluetooth® antennas. People with implanted pacemakers or cardiac defibrillators should maintain a reasonable distance between themselves and the Bluetooth® antennas. The radio waves may affect the operation of such devices.
- Before using Bluetooth® devices, users of any electrical medical device other than implanted pacemakers and implanted cardiac defibrillators should consult the manufacturer of the device for information about its operation under the influence of audio waves. Radio waves could have unexpected effects on the operation of such medical devices.

 NOTICE

■ **To prevent damage to portable players**

Do not leave portable players in the vehicle. The temperature inside the vehicle may become high, resulting in damage to the player.

FarmaSOS.com

3-3. Using the Bluetooth® audio system

Using the Bluetooth® audio system

■ Audio unit

Type A

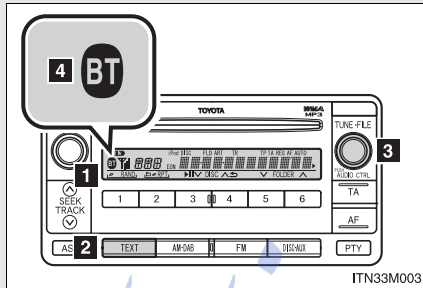

1 Display

A message, name, number, etc. is displayed.

Lower-case characters and special characters cannot be displayed.

2 Displays information that is too long to be displayed at one time on the display (press and hold)

3 Selects items such as menu and number

Turn: Selects an item

Press: Inputs the selected item

4 Bluetooth® connection condition

If "BT" is not displayed, the Bluetooth® audio system cannot be used.

Type B

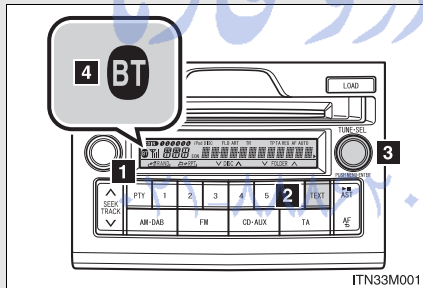

3

Interior features

FarmaSOS

Using the Bluetooth® audio system for the first time

Before using the Bluetooth® audio system, it is necessary to register a Bluetooth® enabled portable player in the system. Follow the procedure below to register (pair) a portable player:

STEP 1 Press the “TUNE•FILE” or “TUNE•SEL” knob and select “BT•A MENU” using the “TUNE•FILE” or “TUNE•SEL” knob.

STEP 2 Select “BT•A Setup” using the “TUNE•FILE” or “TUNE•SEL” knob.

STEP 3 Select “Pair Audio” using the “TUNE•FILE” or “TUNE•SEL” knob.

STEP 4 Select “Record Name” using the “TUNE•FILE” or “TUNE•SEL” knob, and say the name to be registered after the beep.

The name to be registered will be repeated aloud.

STEP 5 Select “Confirm” using the “TUNE•FILE” or “TUNE•SEL” knob.

A passkey will be displayed.

STEP 6 Input the passkey into the audio player.

Refer to the manual that comes with the portable player for the operation of the portable player.

If the portable player has a Bluetooth® phone, the phone can be registered at the same time.

STEP 7 When “Pair Phone?” is displayed, select “Yes” or “No” using the “TUNE•FILE” or “TUNE•SEL” knob.
(Bluetooth® phone →P. 526)

Menu list of the Bluetooth® audio system

First menu	Second menu	Third menu	Operation detail
"Setup"	"BT•A Setup"	"Pair Audio"	Registering a portable audio player
		"Select Audio"	Selecting a portable audio player to be used
		"Change Name"	Changing the registered name of a portable player
		"List Audios"	Listing the registered portable players
		"Set Passkey"	Changing the passkey
		"Delete Audio"	Deleting a registered portable player
	"System Setup"	"Guidance Vol"	Setting voice guidance volume
		"Device Name"	Displaying the Bluetooth® device address and name
		"Initialize"	Initializing the system

3

Interior features

■ **Operations that cannot be performed while driving**

- Operating the system with the "TUNE•FILE" or "TUNE•SEL" knob
- Registering a portable player to the system

■ **Changing the passkey**

→P. 520

3-3. Using the Bluetooth® audio system Operating a Bluetooth® enabled portable player

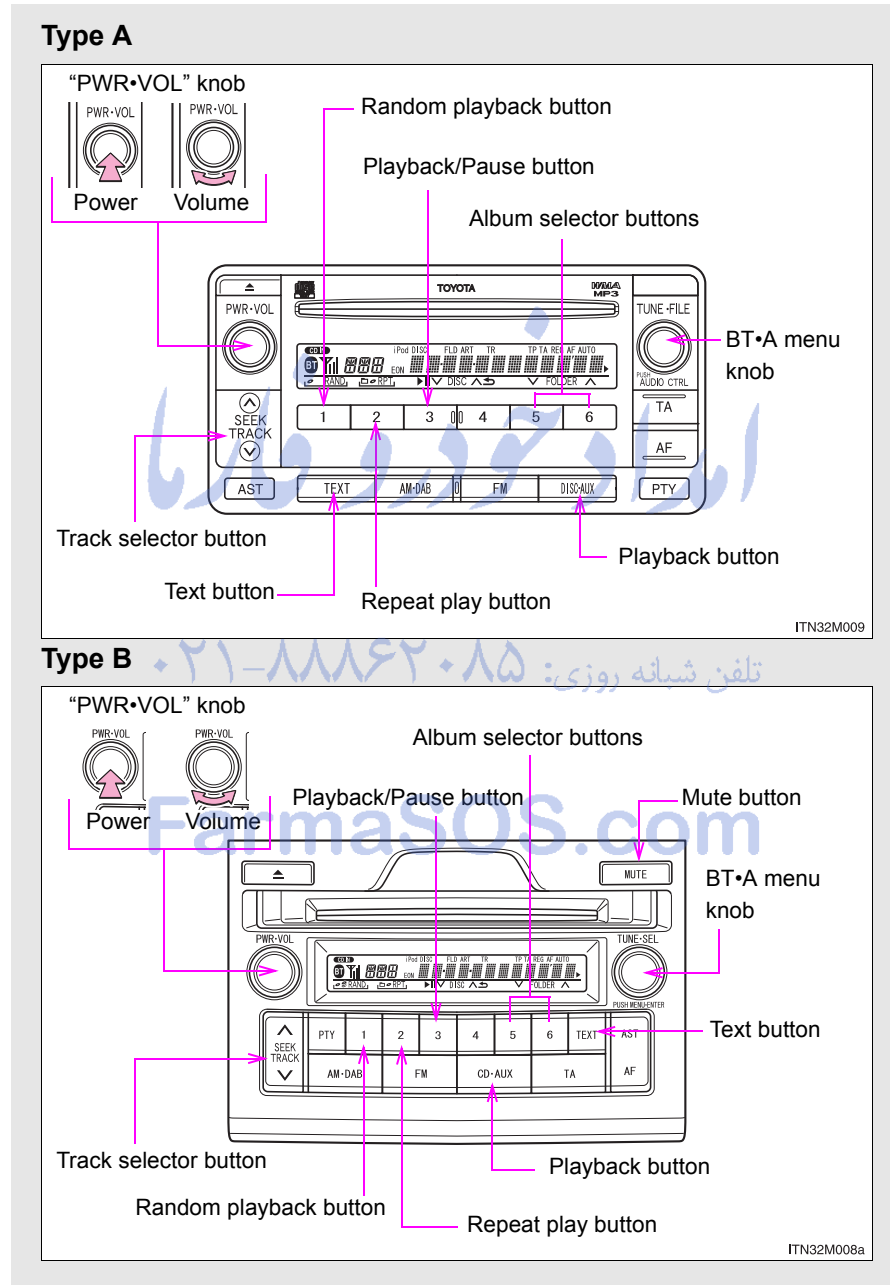

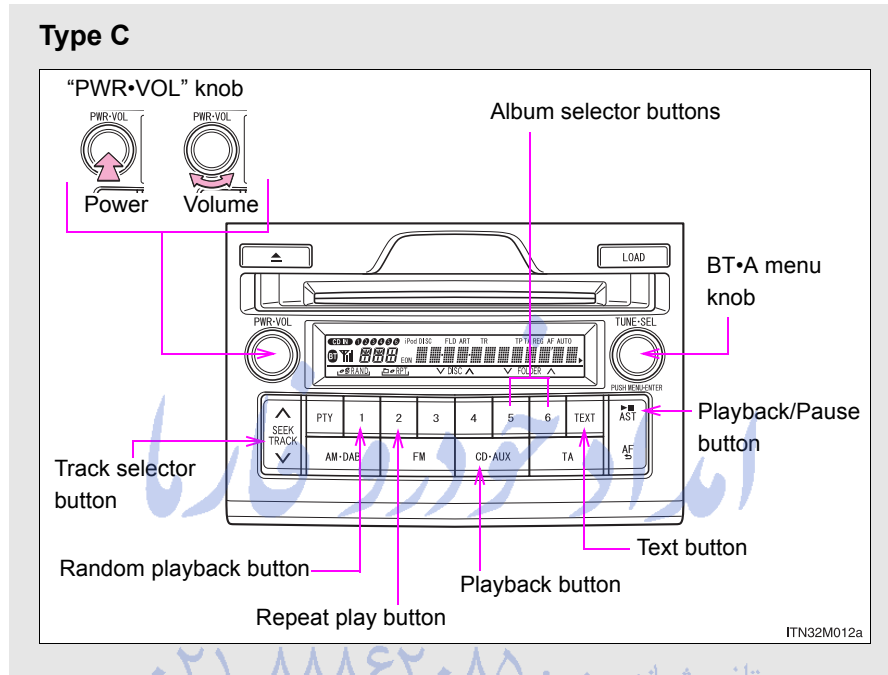

Selecting an album

To select the desired album, press the 6 (^) or 5 (v) button.

Selecting tracks

Press “^” or “v” on the “SEEK/TRACK” button to select the desired track.

3-3. Using the Bluetooth® audio system

Playing and pausing tracks

To play or pause a track, press the 3 (▶||) or “AST” (▶||) button.

Fast-forwarding and rewinding tracks

To fast-forward or rewind, press and hold “^” or “v” on the “SEEK/ TRACK” button until you hear a beep.

Random playback

Press the 1 (RAND) button.

To cancel, press the 1 (RAND) button again.

Repeat play

Press the 2 (RPT) button.

To cancel, press the 2 (RPT) button again.

Switching the display

Press the “TEXT” button.

Each time the button is pressed, the display changes in the following order: Elapsed time → Album title → Track title → Artist name

Silencing the sound (type B)

Press the “MUTE” button.

Press the button again to turn the system back on.

Using the steering wheel audio switches

→P. 501

■ Bluetooth® audio system functions

Depending on the portable player that is connected to the system, certain functions may not be available.

■ Display

→P. 464

■ Error messages

“Memory Error”: This indicates a problem in the system.

تلفن شبانه روزی: ۰۲۱-۸۸۶۲۰۸۵

FarmaSOS.com

3-3. Using the Bluetooth® audio system

Setting up a Bluetooth® enabled portable player

Registering a portable audio player in the Bluetooth® audio system allows the system to function. The following functions can be used for registered portable players:

■ Functions and operation procedures

To enter the menu for each function, follow the steps below.

STEP 1 Press the “TUNE•FILE” or “TUNE•SEL” knob to select “BT•A MENU” or press the off-hook switch (→P. 533) and select “Setup” using the “TUNE•FILE” or “TUNE•SEL” knob.

STEP 2 Select “BT•A Setup” using the “TUNE•FILE” or “TUNE•SEL” knob.

STEP 3 Select one of the following items using the “TUNE•FILE” or “TUNE•SEL” knob:

- Registering a portable player
“Pair Audio”
- Selecting a portable player to be used
“Select Audio”
- Changing the registered name of a portable player
“Change Name”
- Listing the registered portable players
“List Audios”
- Changing the passkey
“Set Passkey”
- Deleting a registered portable player
“Delete Audio”

Registering a portable player

Select “Pair Audio” using the “TUNE•FILE” or “TUNE•SEL” knob, and perform the procedure for registering a portable player. (→P. 512)

Selecting a portable player to be used

STEP 1 Select “Select Audio” using the “TUNE•FILE” or “TUNE•SEL” knob.

STEP 2 Select the portable player to be used using the “TUNE•FILE” or “TUNE•SEL” knob.

STEP 3 Select “From Car” or “From Audio” using the “TUNE•FILE” or “TUNE•SEL” knob.

If “From Car” is selected, the portable player will be automatically connected whenever:

Vehicles without a smart entry & start system

The engine switch is in the “ACC” or “ON” position.

Vehicles with a smart entry & start system

The “ENGINE START STOP” switch is in ACCESSORY or IGNITION ON mode.

FarmaSOS.com

Changing the registered name of a portable player

STEP 1 Select “Change Name” using the “TUNE•FILE” or “TUNE•SEL” knob.

STEP 2 Select the desired portable player name to be changed using the “TUNE•FILE” or “TUNE•SEL” knob.

STEP 3 Select “Record Name” using the “TUNE•FILE” or “TUNE•SEL” knob, and say the new name after the beep.

The name to be registered will be repeated aloud.

STEP 4 Select “Confirm” using the “TUNE•FILE” or “TUNE•SEL” knob.

Listing the registered portable players

Select “List Audios” using the “TUNE•FILE” or “TUNE•SEL” knob. The list of registered portable players will be read aloud.

When listing is complete, the system returns to “BT•A Setup”.

Changing the passkey

STEP 1 Select “Set Passkey” using the “TUNE•FILE” or “TUNE•SEL” knob.

STEP 2 Select a 4 to 8-digit number using the “TUNE•FILE” or “TUNE•SEL” knob.

The number should be input 1 digit at a time.

STEP 3 When the entire number to be registered as a passkey has been input, press the “TUNE•FILE” or “TUNE•SEL” knob again.

If the number to be registered has 8 digits, pressing of the knob is not necessary.

Deleting a registered portable player

STEP 1 Select “Delete Audio” using the “TUNE•FILE” or “TUNE•SEL” knob.

STEP 2 Select the desired portable player to be deleted using the “TUNE•FILE” or “TUNE•SEL” knob.

If the portable player to be deleted is paired as a Bluetooth® phone, the registration of the mobile phone can be deleted at the same time.

STEP 3 When “Del Phone?” is displayed, select “Yes” or “No” using the “TUNE•FILE” or “TUNE•SEL” knob.
(Bluetooth® phone →P. 526)

■ The number of portable players that can be registered

Up to 2 portable players can be registered in the system.

تلفن شبانه روزی: ۰۲۱-۸۸۶۲۰۸۵

FarmaSOS.com

3-3. Using the Bluetooth® audio system

Bluetooth® audio system setup

■ System setup items and operation procedures

To enter the menu of each setting, follow the steps below.

STEP 1 Press the “TUNE•FILE” or “TUNE•SEL” knob to select “BT•A MENU” or press the off-hook switch (→P. 533) and select “Setup” using the “TUNE•FILE” or “TUNE•SEL” knob.

STEP 2 Select “System Setup” using the “TUNE•FILE” or “TUNE•SEL” knob.

STEP 3 Select one of the following items using the “TUNE•FILE” or “TUNE•SEL” knob:

- Setting voice guidance volume
“Guidance Vol” (→P. 549)
- Displaying the Bluetooth® device address and name
“Device Name” (→P. 549)
- Initializing the system
“Initialize” (→P. 549)

FarmaSOS.com

3-4. Using the hands-free system (for mobile phone) Hands-free system (for mobile phone)*

The hands-free system is a function that allows you to use your mobile phone without touching it.

This system supports Bluetooth® mobile phones. Bluetooth® is a wireless data system that allows the mobile phone to wirelessly connect to the hands-free system and make/receive calls.

Vehicles with a navigation system

Refer to the “Navigation System Owner’s Manual”.

Vehicles without a navigation system

■ Hands-free system quick guide

STEP 1 Setting a mobile phone. (→P. 534)

STEP 2 Adding an entry to the phonebook. (Up to 20 names can be stored.) (→P. 551)

STEP 3 Dialing by inputting a name. (→P. 539)

■ Hands-free function list

Title	Page
Using the hands-free system ■ Using the hands-free phone system for the first time	P. 532

*: If equipped

3-4. Using the hands-free system (for mobile phone)

Title	Page
<p>Making a phone call</p> <ul style="list-style-type: none">■ Making a phone call<ul style="list-style-type: none">• Dialing by inputting a name• Speed dialing• Redial• Call back■ Receiving a phone call<ul style="list-style-type: none">• Answering the phone• Refusing the call■ Transferring a call■ Using a call history memory<ul style="list-style-type: none">• Dialing• Storing data in the phone book• Deleting	P. 539
<p>Setting a mobile phone</p> <ul style="list-style-type: none">■ Functions and operation procedures	P. 543
<p>Security and system setup</p> <ul style="list-style-type: none">■ Security setting items and operation procedure■ System setup items and operation procedure	P. 546

3-4. Using the hands-free system (for mobile phone)

Title	Page
Using the phone book <ul style="list-style-type: none">■ Adding a new phone number■ Changing the registered name in the phone book■ Listing the registered data■ Setting speed dials■ Deleting the registered data■ Deleting speed dials	P. 551

■ Conditions under which the system will not operate

- If using a mobile phone that does not support Bluetooth®.
- If the mobile phone is switched off.
- If you are outside service range.
- If the mobile phone is not connected.
- If the mobile phone's battery is low.
- The mobile phone is behind the seat or in the glove box or console box
- Metal is covering or touching the phone

■ Signal status

This display may not correspond exactly with the mobile phone itself.

3-4. Using the hands-free system (for mobile phone)

■ When using the hands-free system

- The audio system and voice guidance are muted when making a call.
- If both parties speak at the same time, it may be difficult to hear.
- If the incoming call volume is overly loud, an echo may be heard.
- Try to face toward the microphone as much as possible when speaking.
- In the following circumstances, it may be difficult to hear the other party:
 - When driving on unpaved roads
 - When driving at high speeds
 - When a window is open
 - When the air conditioning is blowing directly on the microphone
 - When the air conditioning is set to high

■ When transferring ownership of the vehicle

Be sure to initialize the system to prevent personal data from being improperly accessed. (→P. 549)

■ About Bluetooth®



Bluetooth is a registered trademark of Bluetooth SIG, Inc.

■ Compatible models

Compatible with HFP (Hands Free Profile) Ver. 1.5 and OPP (Object Push Profile) Ver. 1.1.

If your mobile phone does not support HFP, you cannot enter the Bluetooth® phone. If your mobile phone supports OPP alone, you cannot use the Bluetooth® phone.

3-4. Using the hands-free system (for mobile phone)

■ Certification for the hands-free system

Pioneer



Manufacturer's Declaration of Conformity

Manufacturer: Pioneer Corporation
4-1, 1-Chome, Meguro, Meguro-Ku
TOKYO, 153 - 8654, JAPAN

EU Representative: Pioneer Europe NV
Haven 1087, Keetberglaan 1
9120 MELSELE, BELGIUM

The EU Directives covered by this Declaration

1999/5/EC R&TTE Directive of the European Parliament and of the Council

2006/95/EC Low Voltage Directive

The product covered by this declaration

CD RDS Receiver Head Unit

model **DEX-MG4397**

The basis on which conformity is being declared

The product identified above complies with the requirements of the Low Voltage Directive and the R&TTE Directive above by meeting following standards:
EN300328 V1.7.1 : 2006, EN301489-1 V1.6.1 : 2005, EN301489-17 V1.2.1 : 2002, ISO7637-2:2004 and EN60065:2002 + A1 : 2006

The technical documentation required to demonstrate that the product meets the requirements of the LVD and R&TTE has been compiled by the signatory below and is available for inspection by the relevant enforcement authorities.

A sample of the product has been tested by the manufacturer.

Technical File No: KCE08-003C

The CE mark was first applied in: 2009

Done at Melsele

05/03/2009

Ivan Vlietinck

Manager Public Affairs

PIONEER EUROPE NV
Haven 1087 - Keetberglaan 1 - 9120 Melsele - Belgium
Telefoon +32 (0)3 570 05 11 - Fax +32 (0)3 570 08 86 - URL <http://www.pioneer-eur.com> - BTW BE 406.999.132 - RPR Dendermonde

3

Interior features

3-4. Using the hands-free system (for mobile phone)



FUJITSU TEN LIMITED
Engineering Management Department
Research & Development Group
2-28, Goshō-dori 1-chome, Hyogo-ku, Kobe, 652-8510, Japan
Tel.: +81.78-682-2031 Fax.: +81.78-671-7160

DECLARATION of CONFORMITY

We, FUJITSU TEN LIMITED of the above address, hereby declare, at our sole responsibility, that the following product conforms to the Essential Requirements of the Radio and Telecommunications Terminal Equipment Directive 1999/5/EC in accordance with the tests conducted to the appropriate requirements of the relevant standards, as listed herewith.

Product: COMB PLAYER A
Model/ Type Number: FT0001a
Directive and Standards used:

Radio :	EN300 328	V1.7.1(2006-10)
EMC :	EN301 489-1	V1.6.1(2005-09)
	EN301 489-17	V1.2.1(2002-08)
Safety :	EN60065	(2002)

Supplementary Information:

CE Mark	تلفن شماره روزی: ۰۲۱-۸۸۸۶۲۰۸۵ C € 0560
Member states intend for use	EU and EFTA
Member states with restrictive use	None

Signature: 
Takao KAMAI

Position: Department General Manager
Engineering Management Department
Research & Development Group

Date of issue: 14 July 2008

Place of issue: Kobe, Japan

3-4. Using the hands-free system (for mobile phone)

FUJITSU TEN LIMITED tímto prohlašuje, že tento FT0001a je ve shodě se základními požadavky a dalšími příslušnými ustanoveními směrnice 1999/5/ES.
Undertegnede FUJITSU TEN LIMITED erklærer herved, at følgende udstyr FT0001a overholder de væsentlige krav og øvrige relevante krav i direktiv 1999/5/EF.
Hiermit erklärt FUJITSU TEN LIMITED, dass sich das Gerät FT0001a in Übereinstimmung mit den grundlegenden Anforderungen und den übrigen einschlägigen Bestimmungen der Richtlinie 1999/5/EG befindet.
Käesolevaga kinnitab FUJITSU TEN LIMITED seadme FT0001a vastavust direktiivi 1999/5/EÜ põhinõuetele ja nimetatud direktiivist tulenevatele teistele asjakohastele sätetele.
Hereby, FUJITSU TEN LIMITED, declares that this FT0001a is in compliance with the essential requirements and other relevant provisions of Directive 1999/5/EC.
Por medio de la presente FUJITSU TEN LIMITED declara que el FT0001a cumple con los requisitos esenciales y cualesquiera otras disposiciones aplicables o exigibles de la Directiva 1999/5/CE.
ΜΕ ΤΗΝ ΠΑΡΟΥΣΑ FUJITSU TEN LIMITED ΔΗΛΩΝΕΙ ΟΤΙ FT0001a ΣΥΜΜΟΡΦΩΝΕΤΑΙ ΠΡΟΣ ΤΙΣ ΟΥΣΙΩΔΕΙΣ ΑΠΑΙΤΗΣΕΙΣ ΚΑΙ ΤΙΣ ΛΟΙΠΕΣ ΣΧΕΤΙΚΕΣ ΔΙΑΤΑΞΕΙΣ ΤΗΣ ΟΔΗΓΙΑΣ 1999/5/EK.
Par la présente FUJITSU TEN LIMITED déclare que l'appareil FT0001a est conforme aux exigences essentielles et aux autres dispositions pertinentes de la directive 1999/5/CE.
Con la presente FUJITSU TEN LIMITED dichiara che questo FT0001a è conforme ai requisiti essenziali ed alle altre disposizioni pertinenti stabilite dalla direttiva 1999/5/CE.
Ar šo FUJITSU TEN LIMITED deklarē, ka FT0001a atbilst Direktīvas 1999/5/EK būtiskajām prasībām un citiem ar to saistītajiem noteikumiem.
Šiuo FUJITSU TEN LIMITED deklaruoja, kad šis FT0001a atitinka esminius reikalavimus ir kitas 1999/5/EB Direktyvos nuostatas.

3

Interior features

3-4. Using the hands-free system (for mobile phone)

<p>Hierbij verklaart FUJITSU TEN LIMITED dat het toestel FT0001a in overeenstemming is met de essentiële eisen en de andere relevante bepalingen van richtlijn 1999/5/EG.</p>
<p>Hawnhekk, FUJITSU TEN LIMITED, jiddikjara li dan FT0001a jikkonforma mal-htigijiet essenzjali u ma provvedimenti oħrajn relevanti li hemm fid-Dirrettiva 1999/5/EC.</p>
<p>Alulírott, FUJITSU TEN LIMITED nyilatkozom, hogy a FT0001a megfelel a vonatkozó alapvető követelményeknek és az 1999/5/EC irányelv egyéb előírásainak.</p>
<p>Niniejszym FUJITSU TEN LIMITED oświadcza, że FT0001a jest zgodny z zasadniczymi wymogami oraz pozostałymi stosownymi postanowieniami Dyrektywy 1999/5/EC.</p>
<p>FUJITSU TEN LIMITED declara que este FT0001a está conforme com os requisitos essenciais e outras disposições da Directiva 1999/5/CE.</p>
<p>FUJITSU TEN LIMITED izjavlja, da je ta FT0001a v skladu z bistvenimi zahtevami in ostalimi relevantnimi določili direktive 1999/5/ES.</p>
<p>FUJITSU TEN LIMITED týmto vyhlasuje, že FT0001a spĺňa základné požiadavky a všetky príslušné ustanovenia Smernice 1999/5/ES.</p>
<p>FUJITSU TEN LIMITED vakuuttaa täten että FT0001a tyypinen laite on direktiivin 1999/5/EY oleellisten vaatimusten ja sitä koskevien direktiivin muiden ehtojen mukainen.</p>
<p>Härmed intygar FUJITSU TEN LIMITED att denna FT0001a står i överensstämmelse med de väsentliga egenskapskrav och övriga relevanta bestämmelser som framgår av direktiv 1999/5/EG.</p>
<p>Hér með lýsir FUJITSU TEN LIMITED yfir því að FT0001a er í samræmi við grunnkröfur og aðrar kröfur, sem gerðar eru í tilskipun 1999/5/EC.</p>
<p>FUJITSU TEN LIMITED erklærer herved at utsyret FT0001a er i samsvar med de grunnleggende krav og øvrige relevante krav i direktiv 1999/5/EF.</p>

 CAUTION

■ **Caution while driving**

Do not use a mobile phone or connect the Bluetooth® phone.

■ **Caution regarding interference with electronic devices**

- Your audio unit is fitted with Bluetooth® antennas. People with implanted pacemakers or cardiac defibrillators should maintain a reasonable distance between themselves and the Bluetooth® antennas. The radio waves may affect the operation of such devices.
- Before using Bluetooth® devices, users of any electrical medical device other than implanted pacemakers and implanted cardiac defibrillators should consult the manufacturer of the device for information about its operation under the influence of audio waves. Radio waves could have unexpected effects on the operation of such medical devices.

 NOTICE

■ **To prevent damage to mobile phones**

Do not leave mobile phones in the vehicle. The temperature inside the vehicle may become high, resulting in damage to the phone.

FarmaSOS.com

3-4. Using the hands-free system (for mobile phone) Using the hands-free system (for mobile phone)

■ Audio unit

Type A

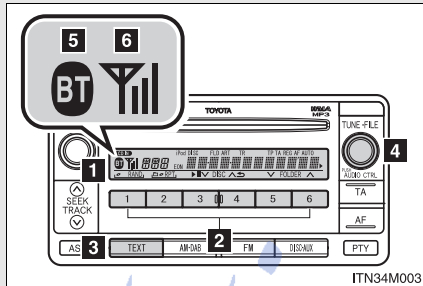

1 Display

A message, name, phone number, etc. is displayed.

Lower-case characters and special characters cannot be displayed.

2 Selects speed dials

3 Displays information that is too long to be displayed at one time on the display (press and hold)

4 Selects items such as menu and number

Turn: Selects an item

Press: Inputs the selected item

5 Bluetooth® connection condition

If "BT" is not displayed, the hands-free system cannot be used.

6 Reception level

Type B

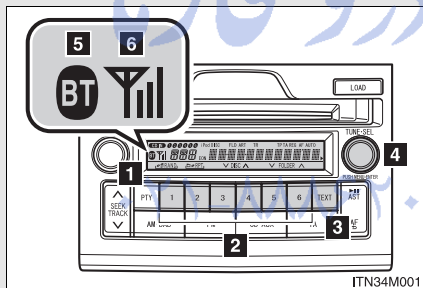

■ Steering wheel switches

Type A

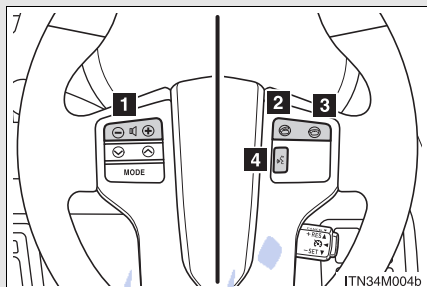

1 Volume

The voice guidance volume cannot be adjusted using this button.

2 Off-hook switch

Turns the hands-free system on/starts a call

3 On-hook switch

Turns the hands-free system off/ends a call/refuses a call

4 Talk switch

Turns the voice command system on (press)/turns the voice command system off (press and hold)

Type B

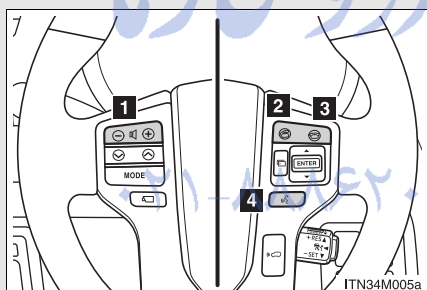

3-4. Using the hands-free system (for mobile phone)

■ Microphone

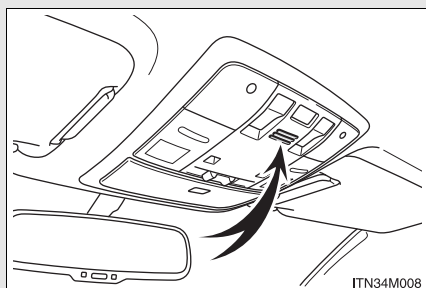

Using the hands-free phone system for the first time

Before using the hands-free phone system, it is necessary to register a mobile phone in the system. The system will enter phone registration mode automatically when starting the system with no mobile phone registered. Follow the procedure below to register (pair) a mobile phone:

تلفن شبانه روزی: ۰۸۵+۸۸۶۲-۱

FarmaSOS.com

3-4. Using the hands-free system (for mobile phone)

STEP 1 Press the off-hook switch and select “Pair phone” using the “TUNE•FILE” or “TUNE•SEL” knob.

STEP 2 Select “Record Name” using the “TUNE•FILE” or “TUNE•SEL” knob, and say the name to be registered after the beep.

The name to be registered will be repeated aloud.

STEP 3 Select “Confirm” using the “TUNE•FILE” or “TUNE•SEL” knob.

A passkey will be displayed.

STEP 4 Input the passkey into the mobile phone.

Refer to the manual that comes with the mobile phone for the operation of the phone.

If the mobile phone has a Bluetooth® audio player, the audio player can be registered at the same time.

STEP 5 When “Pair Audio?” is displayed, select “Yes” or “No” using the “TUNE•FILE” or “TUNE•SEL” knob.

(Bluetooth® audio player →P. 505)

تلفن شبانه روزی: ۰۲۱-۸۸۶۲۰۸۵

3

Interior features

FarmaSOS.com

3-4. Using the hands-free system (for mobile phone)

Menu list of the hands-free phone system

First menu	Second menu	Third menu	Operation detail
"Callback"	-	-	Dialing a number stored in the incoming call history memory
"Redial"	-	-	Dialing a number stored in the outgoing call history memory
"Phone-book"	"Add Entry"	-	Adding a new phone number
	"Change Name"	-	Changing the registered name in the phone book
	"Delete Entry"	-	Deleting the registered data
	"Del Spd Dial"	-	Deleting speed dials
	"List Names"	-	Listing the registered data
	"Speed Dial"	-	Setting speed dials

3-4. Using the hands-free system (for mobile phone)

First menu	Second menu	Third menu	Operation detail
"Setup"	"Security"	"Set PIN"	Setting a PIN code
		"Phbk Lock"	Locking the phone book
		"Phbk Unlock"	Unlocking the phone book
	"Phone Setup"	"Pair Phone"	Registering a mobile phone
		"Select Phone"	Selecting a mobile phone to be used
		"Change Name"	Changing the registered name of a mobile phone
		"List Phones"	Listing the registered mobile phones
		"Set Passkey"	Changing the passkey
		"Delete Phone"	Deleting a registered mobile phone
	"System Setup"	"Guidance Vol"	Setting voice guidance volume
		"Device Name"	Displaying the Bluetooth® device address and name
		"Initialize"	Initializing the system

3-4. Using the hands-free system (for mobile phone)

■ Automatic volume adjustment

When vehicle speed reaches 80 km/h (50 mph) or more, the volume automatically increases. The volume returns to the previous volume setting when vehicle speed drops to 70 km/h (43 mph) or less.

■ Operations that cannot be performed while driving

- Operating the system with the "TUNE•FILE" or "TUNE•SEL" knob
- Registering a mobile phone to the system

■ Changing the passkey

→P. 545

امداد خودرو فارما

تلفن شبانه روزی: ۰۲۱-۸۸۸۶۲۰۸۵

FarmaSOS.com

3-4. Using the hands-free system (for mobile phone)

Making a phone call

- **Making a phone call**
 - Dialing by inputting a name
“Dial by name”
 - Speed dialing
 - Dialing a number stored in the outgoing history memory
“Redial”
 - Dialing a number stored in the incoming history memory
“Call back”
- **Receiving a phone call**
 - Answering the phone
 - Refusing the call
- **Transferring a call**
- **Using the call history memory**
 - Dialing
 - Storing data in the phone book
 - Deleting

FarmaSOS.com

3-4. Using the hands-free system (for mobile phone)

Dialing by inputting a name

STEP 1 Press the talk switch and say a registered name.

The desired name or number is displayed.

STEP 2 Dial by one of the following methods:

a. Press the off-hook switch.

b. Select "Dial" using the "TUNE•FILE" or "TUNE•SEL" knob.

In **STEP 1**, if the pronounced name cannot be recognized, select the desired name using the "TUNE•FILE" or "TUNE•SEL" knob.

Speed dialing

STEP 1 Press the off-hook switch.

STEP 2 Press the preset button in which the desired number is registered.

STEP 3 Press the off-hook switch.

When receiving a phone call

■ Answering the phone

Press the off-hook switch.

■ Refusing the call

Press the on-hook switch.

Transferring a call

A call can be transferred between the mobile phone and system while dialing, receiving a call, or during a call. Use one of the following methods:

- a. Operate the mobile phone.

Refer to the manual that comes with the mobile phone for the operation of the phone.

- b. Press the off-hook switch*.

*: This operation can be performed only when transferring a call from the mobile phone to the system during a call.

Using a call history memory

Follow the procedure below to use number stored in call history memory:

STEP 1 Press the off-hook switch and select “Redial” (when using a number stored in the outgoing call history memory) or “Call back” (when using a number stored in the incoming call history memory) using the “TUNE•FILE” or “TUNE•SEL” knob.

STEP 2 Select the desired number using the “TUNE•FILE” or “TUNE•SEL” knob.

3-4. Using the hands-free system (for mobile phone)

STEP 3 The following operations can be performed:

Dialing: Press the off-hook switch or select “Dial” using the “TUNE•FILE” or “TUNE•SEL” knob.

Storing the number in the phone book: Select “Store” and then “Confirm” using the “TUNE•FILE” or “TUNE•SEL” knob.

Deleting: Select “Delete” and then “Confirm” using the “TUNE•FILE” or “TUNE•SEL” knob.

■ Call history

Up to 5 numbers can be stored in each of the outgoing and incoming call history memories.

■ When talking on the phone

- Do not talk simultaneously with the other party.
- Keep the volume of the receiving voice down. Otherwise, voice echo will increase.

تلفن شبانه روزی: ۰۲۱-۸۸۶۲۰۸۵

FarmaSOS.com

3-4. Using the hands-free system (for mobile phone) Setting a mobile phone

Registering a mobile phone in the hands-free phone system allows the system to function. The following function can be used for registered mobile phones:

■ Functions and operation procedures

To enter menu for each function, follow the steps below.

STEP 1 Press the off-hook switch and select “Setup” using the “TUNE•FILE” or “TUNE•SEL” knob.

STEP 2 Select “Phone Setup” using the “TUNE•FILE” or “TUNE•SEL” knob.

STEP 3 Select one of the following items using the “TUNE•FILE” or “TUNE•SEL” knob:

- Registering a mobile phone
“Pair Phone”
- Selecting a mobile phone to be used
“Select Phone”
- Changing the registered name of a mobile phone
“Change Name”
- Listing the registered mobile phones
“List Phones”
- Changing the passkey
“Set Passkey”
- Deleting a registered mobile phone
“Delete Phone”

3-4. Using the hands-free system (for mobile phone)

Registering a mobile phone

Select "Pair Phone" using the "TUNE•FILE" or "TUNE•SEL" knob, and perform the procedure for registering a mobile phone. (→P. 534)

Selecting a mobile phone to be used

STEP 1 Select "Select Phone" using the "TUNE•FILE" or "TUNE•SEL" knob.

STEP 2 Select the mobile phone to be used using the "TUNE•FILE" or "TUNE•SEL" knob.

Changing the registered name of a mobile phone

STEP 1 Select "Change Name" using the "TUNE•FILE" or "TUNE•SEL" knob.

STEP 2 Select the desired mobile phone name to be changed using the "TUNE•FILE" or "TUNE•SEL" knob.

STEP 3 Select "Record Name" using the "TUNE•FILE" or "TUNE•SEL" knob, and say the new name after the beep.

The name to be registered will be repeated aloud.

STEP 4 Select "Confirm" using the "TUNE•FILE" or "TUNE•SEL" knob.

Listing the registered mobile phones

Select "List Phones" using the "TUNE•FILE" or "TUNE•SEL" knob. The list of registered mobile phones will be read aloud.

When listing is complete, the system returns to "Phone Setup".

Changing the passkey

STEP 1 Select “Set Passkey” using the “TUNE•FILE” or “TUNE•SEL” knob.

STEP 2 Select a 4 to 8-digit number using the “TUNE•FILE” or “TUNE•SEL” knob.

The number should be input 1 digit at a time.

STEP 3 When the entire number to be registered as a passkey has been input, press the “TUNE•FILE” or “TUNE•SEL” knob again.

If the number to be registered has 8 digits, pressing of the knob is not necessary.

Deleting a registered mobile phone

STEP 1 Select “Delete Phone” using the “TUNE•FILE” or “TUNE•SEL” knob.

STEP 2 Select the desired mobile phone to be deleted using the “TUNE•FILE” or “TUNE•SEL” knob.

If the mobile phone to be deleted is paired as a Bluetooth® audio player, the registration of the audio player can be deleted at the same time.

STEP 3 When “Del Audio?” is displayed, select “Yes” or “No” using the “TUNE•FILE” or “TUNE•SEL” knob.

(Bluetooth® audio player →P. 505)

■ The number of mobile phones that can be registered

Up to 6 mobile phones can be registered in the system.

3-4. Using the hands-free system (for mobile phone)

Security and system setup

To enter the menu of each setting, follow the steps below.

■ Security setting items and operation procedures

STEP 1 Press the off-hook switch and select “Setup” using the “TUNE•FILE” or “TUNE•SEL” knob.

STEP 2 Select “Security” using the “TUNE•FILE” or “TUNE•SEL” knob.

STEP 3 Select one of the following items using the “TUNE•FILE” or “TUNE•SEL” knob:

- Setting or changing the PIN (Personal Identification Number)
“Set PIN”
- Locking the phone book
“Phbk Lock”
- Unlocking the phone book
“Phbk Unlock”

تلفن شبانه روزی: ۰۲۱-۸۸۸۶۲۰۸۵

FarmaSOS.com

3-4. Using the hands-free system (for mobile phone)

■ System setup items and operation procedures

STEP 1 Press the off-hook switch and select “Setup” using the “TUNE•FILE” or “TUNE•SEL” knob.

STEP 2 Select “System Setup” using the “TUNE•FILE” or “TUNE•SEL” knob.

STEP 3 Select one of the following items using the “TUNE•FILE” or “TUNE•SEL” knob:

- Setting voice guidance volume
“Guidance Vol”
- Displaying the Bluetooth® device address and name
“Device Name”
- Initializing the system
“Initialize”

3

Interior features

تلفن شبانه روزی: ۰۲۱-۸۸۶۲۰۸۵

FarmaSOS.com

Setting or changing the PIN

■ Setting a PIN

STEP 1 Select “Set PIN” using the “TUNE•FILE” or “TUNE•SEL” knob.

STEP 2 Enter a PIN using the “TUNE•FILE” or “TUNE•SEL” knob.

Input the code 1 digit at a time.

■ Changing the PIN

STEP 1 Select “Set PIN” using the “TUNE•FILE” or “TUNE•SEL” knob.

STEP 2 Enter the registered PIN using the “TUNE•FILE” or “TUNE•SEL” knob.

STEP 3 Enter a new PIN using the “TUNE•FILE” or “TUNE•SEL” knob.

Input the code 1 digit at a time.

Locking or unlocking the phone book

STEP 1 Select “Phbk Lock” or “Phbk Unlock” using the “TUNE•FILE” or “TUNE•SEL” knob.

STEP 2 Input a new PIN by using the “TUNE•FILE” or “TUNE•SEL” knob and select “Confirm” using the “TUNE•FILE” or “TUNE•SEL” knob.

Input the code 1 digit at a time.

Setting voice guidance volume

STEP 1 Select “Guidance Vol” using the “TUNE•FILE” or “TUNE•SEL” knob.

STEP 2 Change the voice guidance volume.

To decrease the volume: Turn the “TUNE•FILE” or “TUNE•SEL” knob counterclockwise.

To increase the volume: Turn the “TUNE•FILE” or “TUNE•SEL” knob clockwise.

Displaying the Bluetooth® device address and name

STEP 1 Select “Device Name” using the “TUNE•FILE” or “TUNE•SEL” knob.

STEP 2 Turn the “TUNE•FILE” or “TUNE•SEL” knob to display the Bluetooth® device address and name.

STEP 3 Select “Go Back” using the “TUNE•FILE” or “TUNE•SEL” knob to return to “System Setup”.

Initializing the system

STEP 1 Select “Initialize” and then “Confirm” using the “TUNE•FILE” or “TUNE•SEL” knob.

STEP 2 Select “Confirm” again using the “TUNE•FILE” or “TUNE•SEL” knob.

■ **Initialization**

- The following data in the system can be initialized:
 - Phone book
 - Outgoing and incoming call history
 - Speed dials
 - Registered mobile phone data
 - Security code
 - Registered Bluetooth® enabled portable player data
 - Passkeys for the mobile phones
 - Passkey for the Bluetooth® audio players
 - Guidance volume
 - Receiver volume
 - Ring tone volume
- Once the initialization has been completed, the data cannot be restored to its original state.

■ **When the phone book is locked**

The following functions cannot be used:

- Dialing by inputting a name
- Speed dialing
- Dialing a number stored in the call history memory
- Using the phone book

FarmaSOS.com

3-4. Using the hands-free system (for mobile phone) Using the phone book

To enter the menu of each setting, follow the steps below.

STEP 1 Press the off-hook switch and select “Phonebook” using the “TUNE•FILE” or “TUNE•SEL” knob.

STEP 2 Select one of the following items using the “TUNE•FILE” or “TUNE•SEL” knob:

- Adding a new phone number
“Add Entry”
- Changing the registered name in the phone book
“Change Name”
- Listing the registered data
“List Names”
- Setting speed dials
“Speed Dial”
- Deleting the registered data
“Delete Entry”
- Deleting speed dials
“Del Spd Dial”

3-4. Using the hands-free system (for mobile phone)

Adding a new phone number

The following methods can be used to add a new phone number:

- Transferring data from the mobile phone
- Inputting a phone number using the “TUNE•FILE” or “TUNE•SEL” knob
- Selecting a phone number from outgoing or incoming call history

■ Adding procedure

STEP 1 Select “Add Entry” using the “TUNE•FILE” or “TUNE•SEL” knob.

STEP 2 Use one of the following methods to input a telephone number:

Transferring data from the mobile phone:

STEP2-1 Select “By Phone” and then “Confirm” using the “TUNE•FILE” or “TUNE•SEL” knob.

STEP2-2 When “Transfer” appears in the display, transfer the data from the mobile phone.

Refer to the manual that comes with the mobile phone for the details of transferring data.

STEP2-3 Select the desired data using the “TUNE•FILE” or “TUNE•SEL” knob.

3-4. Using the hands-free system (for mobile phone)

Inputting a phone number using the “TUNE•FILE” or “TUNE•SEL” knob:

STEP2-1 Select “Manual Input” using the “TUNE•FILE” or “TUNE•SEL” knob.

STEP2-2 Input a phone number using the “TUNE•FILE” or “TUNE•SEL” knob, and press the “TUNE•FILE” or “TUNE•SEL” knob again.

Input the phone number 1 digit at a time.

Selecting a phone number from outgoing or incoming call history:

STEP2-1 Select “Call History” using the “TUNE•FILE” or “TUNE•SEL” knob.

STEP2-2 Select “Outgoing” or “Incoming” using the “TUNE•FILE” or “TUNE•SEL” knob.

STEP2-3 Select the desired data using the “TUNE•FILE” or “TUNE•SEL” knob.

STEP 3 Select “Record Name” using the “TUNE•FILE” or “TUNE•SEL” knob, and say the desired name after the beep.

The name to be registered will be repeated aloud.

STEP 4 Select “Confirm” using the “TUNE•FILE” or “TUNE•SEL” knob.

STEP 5 Select “Confirm” again using the “TUNE•FILE” or “TUNE•SEL” knob.

In **STEP 5**, selecting “Speed Dial” instead of “Confirm” registers the newly added phone number as a speed dial.

Changing the registered name in the phone book

STEP 1 Select “Change Name” using the “TUNE•FILE” or “TUNE•SEL” knob.

STEP 2 Select the desired name to be changed using the “TUNE•FILE” or “TUNE•SEL” knob.

STEP 3 Select “Record Name” using the “TUNE•FILE” or “TUNE•SEL” knob, and say the new name after the beep.

The name to be registered will be repeated aloud.

STEP 4 Select “Confirm” using the “TUNE•FILE” or “TUNE•SEL” knob.

Listing the registered data

Selecting “List Names” using the “TUNE•FILE” or “TUNE•SEL” knob. The list of the registered data will be read aloud.

When listing is complete, the system returns to “Phonebook”.

Pressing the off-hook switch while an entry is being read aloud selects the entry, and calls the registered phone number.

FarmaSOS.com

Setting speed dials

- STEP 1** Select “Speed Dial” using the “TUNE•FILE” or “TUNE•SEL” knob.
- STEP 2** Select the desired data using the “TUNE•FILE” or “TUNE•SEL” knob.
- STEP 3** Select the desired preset button, and register the data into speed dial by either of the following methods:
- Press the desired preset button, and select “Confirm” using the “TUNE•FILE” or “TUNE•SEL” knob.
 - Press and hold the desired preset button.

Deleting the registered data

- STEP 1** Select “Delete Entry” using the “TUNE•FILE” or “TUNE•SEL” knob.
- STEP 2** Select the desired data to be deleted using the “TUNE•FILE” or “TUNE•SEL” knob.

FarmaSOS.com

3-4. Using the hands-free system (for mobile phone)

Deleting speed dials

STEP 1 Select “Del Spd Dial” using the “TUNE•FILE” or “TUNE•SEL” knob.

STEP 2 Press the preset button to which the desired speed dial is registered after the beep.

The name to be deleted will be heard.

STEP 3 Select “Confirm” using the “TUNE•FILE” or “TUNE•SEL” knob.

■ Limitation of number of digits

A phone number that exceeds 24 digits cannot be registered.

تلفن شبانه روزی: ۰۲۱-۸۸۸۶۲۰۸۵

FarmaSOS.com

3-5. Using the interior lights

Interior lights list

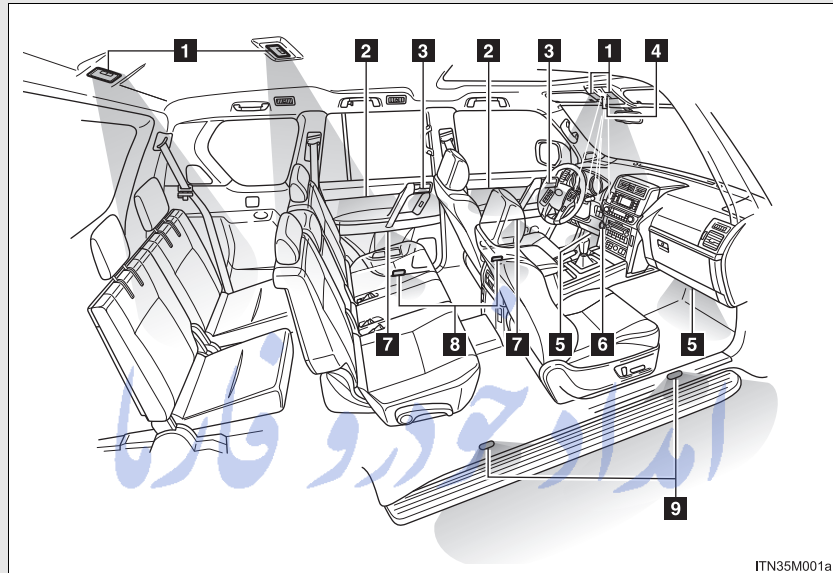

- 1** Personal/interior lights (→P. 559)
- 2** Ornament illumination* (if equipped)
- 3** Inside door handle lights* (if equipped)
- 4** Shift lever light (when the engine switch is in the “ACC” or “ON” position [vehicles without a smart entry & start system] or the “ENGINE START STOP” switch is in ACCESSORY or IGNITION ON mode [vehicles with a smart entry & start system]) (if equipped)

- 5** Footwell lights* (if equipped)
- 6** Engine switch light (vehicles without smart entry & start system) or “ENGINE START STOP” switch light (vehicles with smart entry & start system)
- 7** Door pocket lights* (if equipped)
- 8** Door courtesy lights
- 9** Running board lights (if equipped)

*: The brightness of the lights can be adjusted (→P. 560)

Personal/interior light main switch

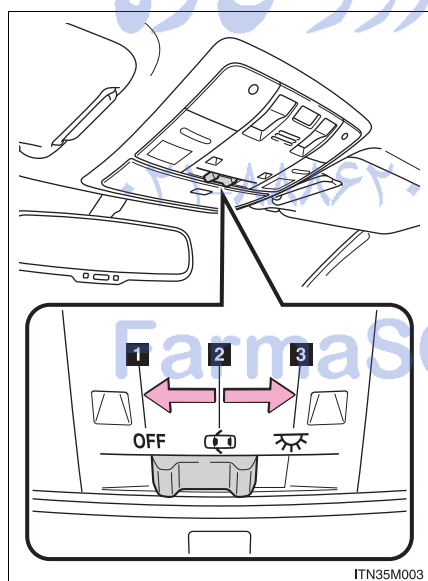

- 1** “OFF”
The personal/Interior lights and interior light can be individually turned on or off.
- 2** Door position
The personal/interior lights come on when a door is opened. They turn off when the doors are closed.
- 3** On
The personal/interior lights cannot be individually turned off.

Personal/interior lights

Front

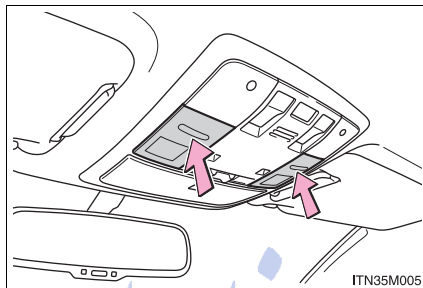

Turns the lights on/off

Rear (without personal lights)

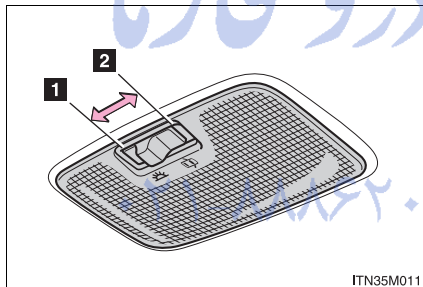

- 1** Turns the lights on
- 2** Turns the door position on

Door position: When the personal/interior light main switch is in the "OFF" position, the lights will not turn on.

Rear (with personal lights)

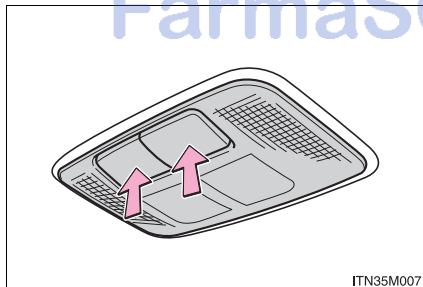

Turns the lights on/off

Lounge illumination control switches (if equipped)

The brightness of the following the lights can be adjusted:

- Inside door handle lights
- Ornament illumination
- Door pocket lights
- Footwell lights

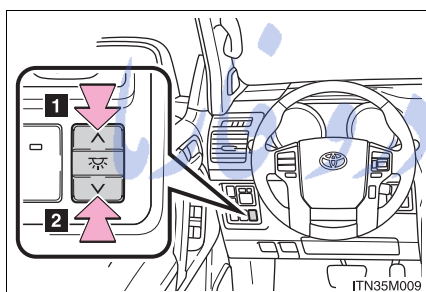

1 Brighter

2 Darker

تلفن شبانه روزی: ۰۲۱-۸۸۶۲۰۸۵

FarmaSOS.com

■ Illuminated entry system

Vehicles without a smart entry & start system

The lights automatically turn on/off according to the engine switch position, whether the doors are locked/unlocked, and whether the doors are open/closed.

Vehicles with a smart entry & start system

The lights automatically turn on/off according to “ENGINE START STOP” switch mode, the presence of the electronic key, whether the doors are locked/unlocked, and whether the doors are open/closed.

■ To prevent battery discharge

If the following lights remain on when the door is not fully closed and the personal/interior light main switch is in the door position, the lights will go off automatically after 20 minutes:

- Personal/interior light
- Inside door handle lights (if equipped)
- Ornament illumination (if equipped)
- Door pocket lights (if equipped)
- Footwell lights (if equipped)
- Running board lights (if equipped)

■ Customization

Settings (e.g. time elapsed before the interior lights turn off) can be changed. (Customizable features →P. 849)

3-6. Using the storage features

List of storage features

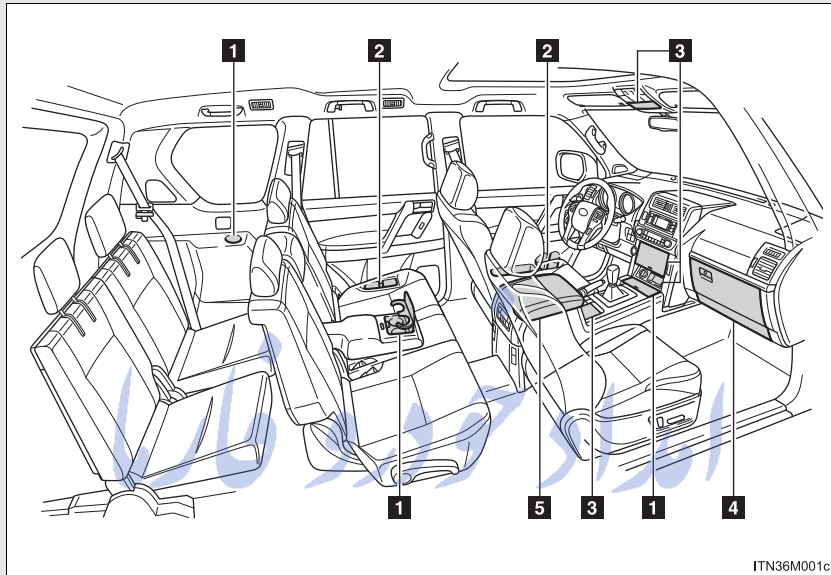

- 1** Cup holders
- 2** Bottle holders/door pockets
- 3** Auxiliary boxes
- 4** Glove box
Card holder (right-hand drive vehicles)
- 5** Console box (if equipped)

⚠ CAUTION**■ Items that should not be left in the storage spaces**

Do not leave glasses, lighters or spray cans in the storage spaces, as this may cause the following when cabin temperature becomes high:

- Glasses may be deformed by heat or cracked if they come into contact with other stored items.
- Lighters or spray cans may explode. If they come into contact with other stored items, the lighter may catch fire or the spray can may release gas, causing a fire hazard.

Glove box

The glove box can be opened by pulling the lever and can be locked and unlocked by using the master key (vehicles without a smart entry & start system) or the mechanical key (vehicles with a smart entry & start system).

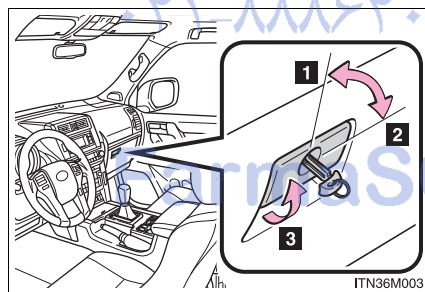

- 1 Unlock
- 2 Lock
- 3 Open

■ **Glove box light**

The glove box light turns on when the tail lights are on.

⚠ CAUTION

■ **Caution while driving**

Keep the glove box closed. In the event of sudden braking or sudden swerving, an accident may occur due to an occupant being struck by the open glove box or the items stored inside.

Card holder (right-hand drive vehicles)

The card holder is located in the glove box.

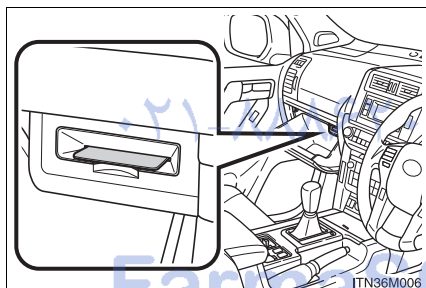

Console box (if equipped)

Your vehicle is equipped with either a console box or cool box.
For vehicles with the cool box, refer to P. 576.

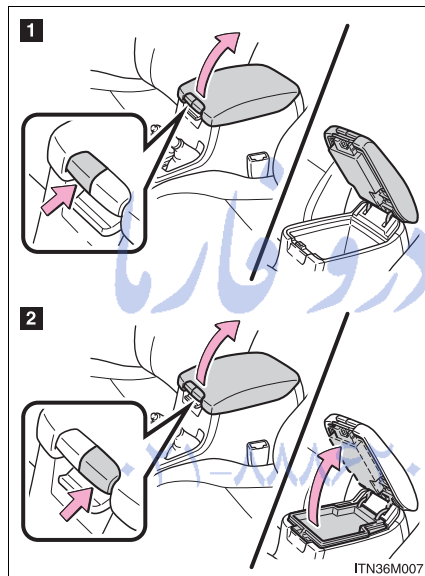
Console box

Lift the lid while pulling up the knob to release the lock.

1 Lifts the lid and tray

2 Lifts the lid

Pull the tray up to open the console box.

3

Interior features

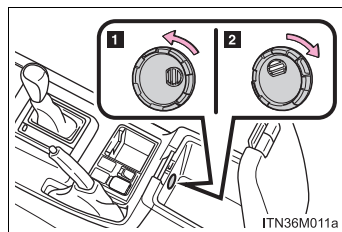
■ Using the console box vent (if equipped)

Air from the air conditioner can be distributed into the console box by opening and closing the vent.

1 Open

2 Close

■ **Items unsuitable for the console box**

- Drinks in unsealed containers
- Fragile items, perishables or anything with strong odor
- Owner's manual, electronic devices, CDs, etc. (when using the console box vent)

■ **When using the console box lid as an armrest**

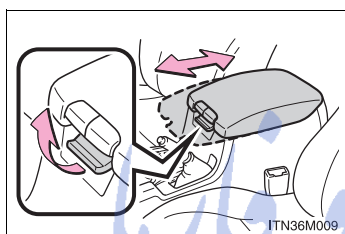

Slide the console box lid forward or backward as needed. Slide the lid while pulling up the lever to release the lock.

⚠ CAUTION

■ **Caution while driving**

Keep the console box closed. In the event of sudden braking or sudden swerving, an accident may occur due to an occupant being struck by the open console box or the items stored inside.

⚠ NOTICE

■ **Tray**

Do not insert items exceeding the height of the tray. Doing so may prevent opening and closing of the lid.

3-6. Using the storage features

Bottle holders/door pockets

Bottle holders/door pockets

Front

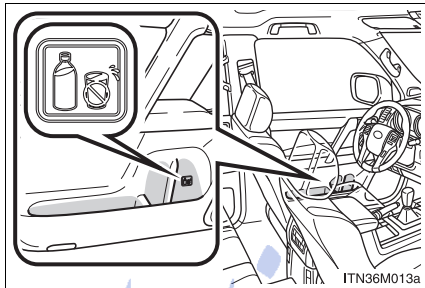

Rear (if equipped)

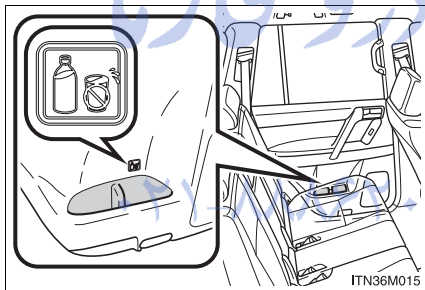

■ **When using the holder as a bottle holder**

- When storing a bottle, close the cap.
- The bottle may not be stored depending on its size or shape.

 **NOTICE**

■ **Items that should not be stowed in the bottle holders**

Do not place open bottles in the bottle holders, or glasses and paper cups containing liquid. The contents may spill and glasses may break.

امداد خودرو فارما

تلفن شبانه روزی: ۰۲۱-۸۸۸۶۲۰۸۵

FarmaSOS.com

Cup holders

Front (vehicles with an automatic transmission)

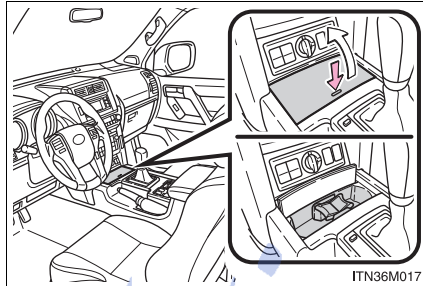

Press down and release the cup holder lid.

You can remove the holder inside.

Front (vehicles with a manual transmission)

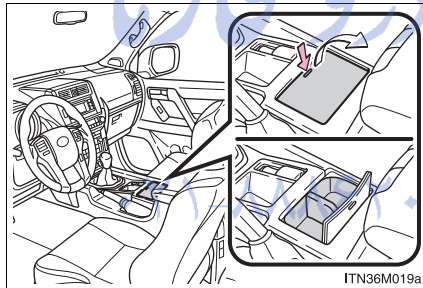

Press down and release the cup holder lid.

You can remove the separate tray inside.

Rear (type A) (if equipped)

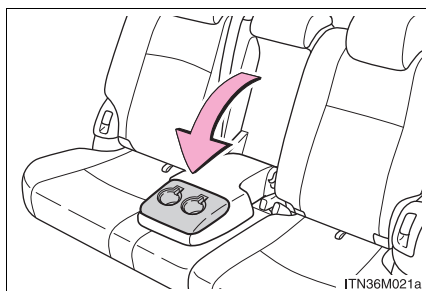

Pull the armrest down.

Rear (type B) (if equipped)

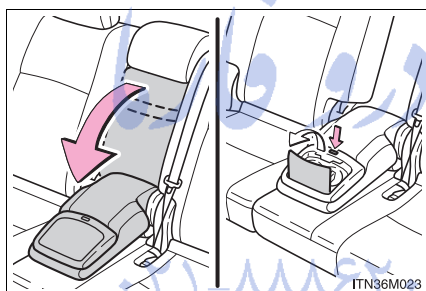

Pull the armrest down and press in and release the button.

Rear (type C) (if equipped)

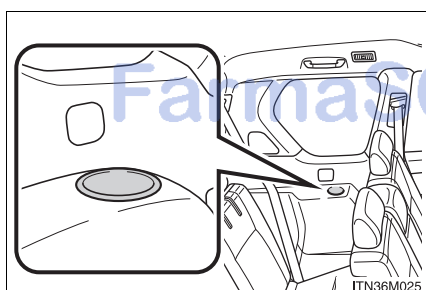

■ Removing the holder, separate tray and adapter

Front (vehicles with an automatic transmission)

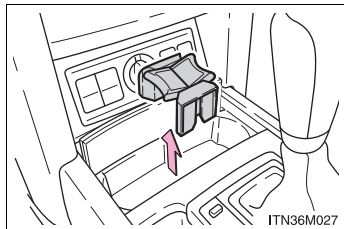

Pull up the holder.

Front (vehicles with a manual transmission)

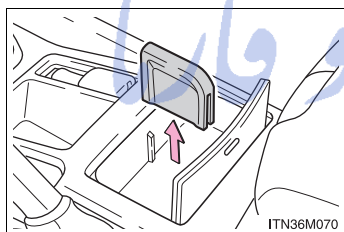

Pull up the separate tray.

Rear (type A)

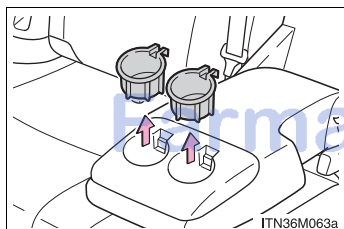

Pull up the adapter.

⚠ CAUTION**■ Items unsuitable for the cup holder**

Do not place anything other than cups, mugs or beverage cans in the cup holders.

Other items may be thrown out of the holders in the event of sudden braking, sudden swerving or an accident, cause injury. If possible, cover hot drinks to prevent burns.

■ When not in use

Keep the cup holders closed. In the event of sudden braking or sudden swerving, an accident may occur due to an occupant being struck by the open cup holders or the items stored inside.

⚠ NOTICE**■ To prevent damage to the rear cup holders (rear [type B])**

Stow the cup holders before stowing the armrest.

تلفن شبانه روزی: ۰۲۱-۸۸۶۲۰۸۵

FarmaSOS.com

Auxiliary boxes

Type A

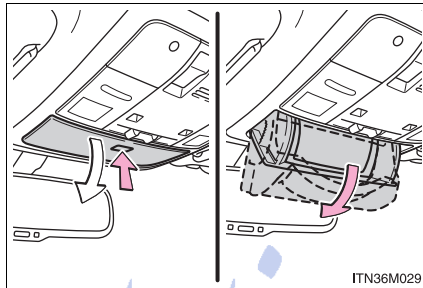

Press in the button and then pull down the lid. The overhead console is useful for temporarily storing sunglasses and similar small items.

Type B (if equipped)

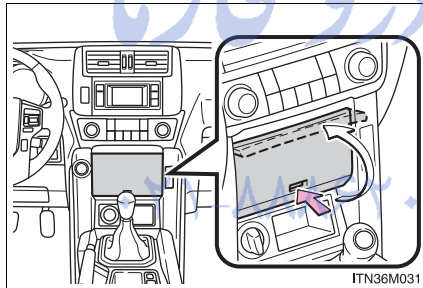

Push the lid.

Type C (if equipped)

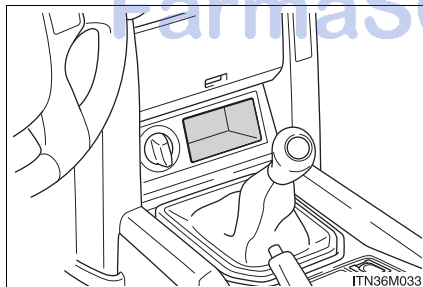

Type D (vehicles with an automatic transmission)

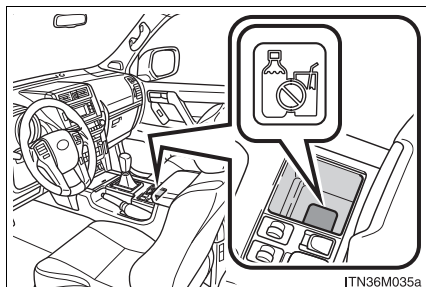

Type D (vehicles with a manual transmission)

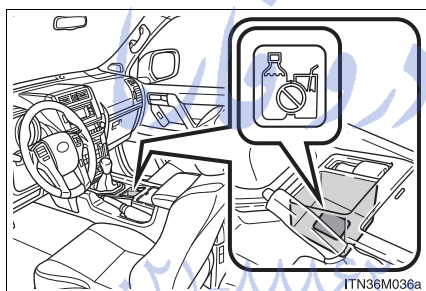

امداد خودرو
تلفن شبانه روزی: ۰۲۱۸۸۸۸۸۸۸۵

FarmaSOS.com

⚠ CAUTION**■ Caution while driving**

- Keep the auxiliary boxes closed. In the event of sudden braking or sudden swerving, an accident may occur due to an occupant being struck by an open auxiliary box or the items stored inside.
- Do not place cups, beverage cans or bottles in the box. They may be thrown out of the box in the event of sudden braking, sudden swerving or an accident, resulting in injury. (type D)

■ Items unsuitable for storing (type A)

- Do not store items heavier than 0.2 kg (0.4 lb.). Doing so may cause the auxiliary box to open and the items inside may fall out, resulting in an accident.
- Do not put large items in the overhead console. The overhead console may not be able to be shut from the conversation mirror state.

تلفن شبانه روزی: ۰۲۱-۸۸۶۲۰۸۵

FarmaSOS.com

3-7. Other interior features

Cool box*

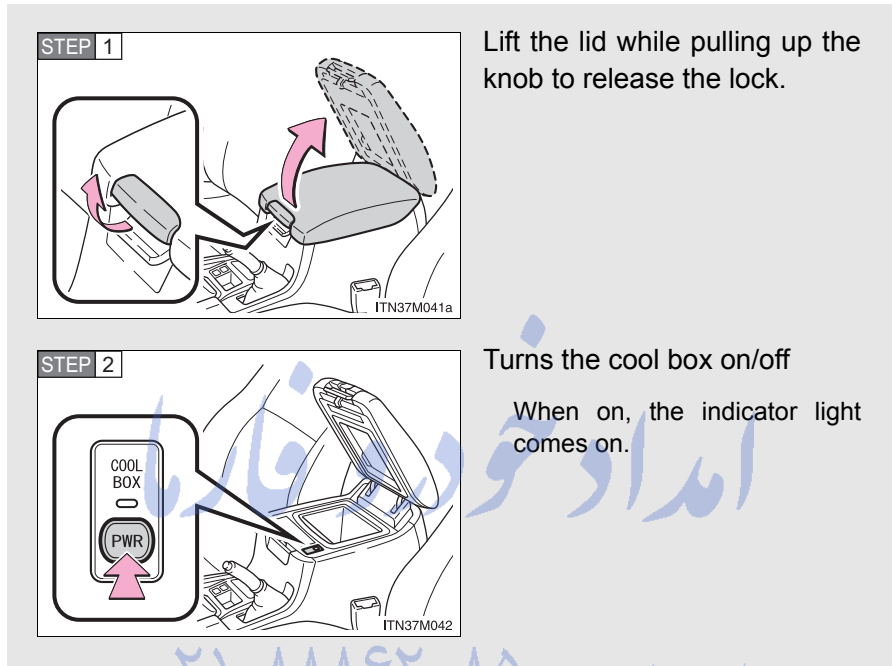

■ The cool box can be operated when

Vehicles without a smart entry & start system

The engine switch is in the "ON" position.

Vehicles with a smart entry & start system

The "ENGINE START STOP" switch is in IGNITION ON mode.

Vehicles with a manual air conditioning system

The air conditioning system must be on to use cool box.

*: If equipped

■ **When the cool box is turned on (vehicles with an automatic air conditioning system)**

Turning cool box on also turns on front air conditioning system.

■ **Items unsuitable for the cool box**

- Drinks in unsealed containers
- Fragile items, perishables or anything with strong odor
- Owner's manual, electronic devices, CDs, etc.

■ **When the indicator light flashes**

The cool box is not operated when any of the following conditions occurs.

- When the air conditioning system is off
Turn the air conditioning system on also turns on the cool box.
- When outside air temperature is about 0 °C (32 °F) or below
- When the indicator light on the "A/C" button (→P. 418, 425) also flashes

Press the "A/C" button to turn off the cooling and dehumidification function and turn it on again.

If the indicator light continues to flash, there may be a malfunction in the system. Turn the air conditioning system off and have it inspected by any authorized Toyota dealer or repairer, or another duly qualified and equipped professional.

■ **When using the cool box lid as an armrest**

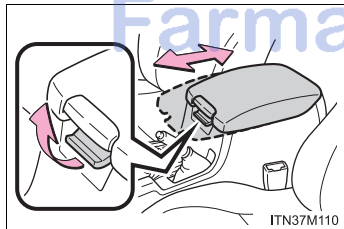

Slide the cool box lid forward or backward as needed. Slide the lid while pulling up the lever to release the lock.

 CAUTION

■ **Caution while driving**

Keep the cool box closed. In the event of sudden braking or sudden swerving, an accident may occur due to an occupant being struck by the open cool box or the items stored inside.

 NOTICE

■ **To prevent battery discharge**

Do not leave the cool box on longer than necessary when the engine is stopped.

تلفن شبانه روزی: ۰۲۱-۸۸۸۶۲۰۸۵

FarmaSOS.com

3-7. Other interior features

Sun visors

Type A

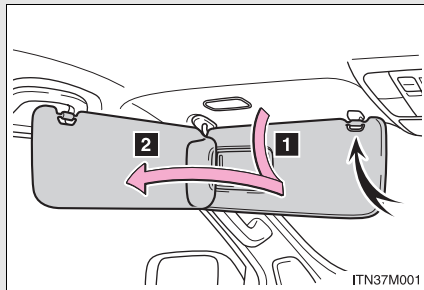

- 1** To set the visor in the forward position, flip it down.
- 2** To set the visor in the side position, flip down, unhook, and swing it to the side.

Type B

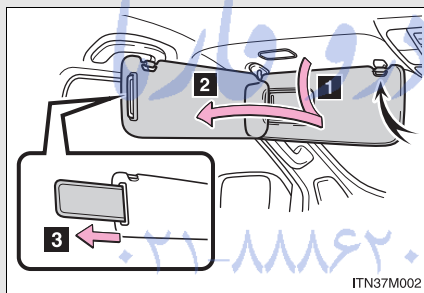

- 1** To set the visor in the forward position, flip it down.
- 2** To set the visor in the side position, flip down, unhook, and swing it to the side.
- 3** To use the side extender, place the visor in the side position, then slide it backward.

3-7. Other interior features

Vanity mirror

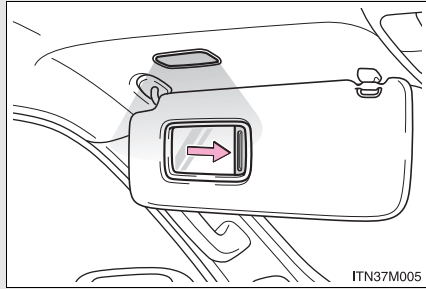

Slide the cover to open.

The light turns on when the cover is opened.

NOTICE

■ **To prevent battery discharge**

Do not leave the vanity lights on for extended periods while the engine is off.

تلفن شبانه روزی: ۰۲۱-۸۸۶۲۰۸۵

FarmaSOS.com

3-7. Other interior features

Clock

Vehicles with a front manual air conditioning system

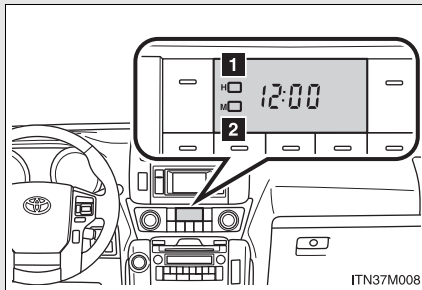

- 1 Adjusts the hours
- 2 Adjusts the minutes

Vehicles with a front automatic air conditioning system

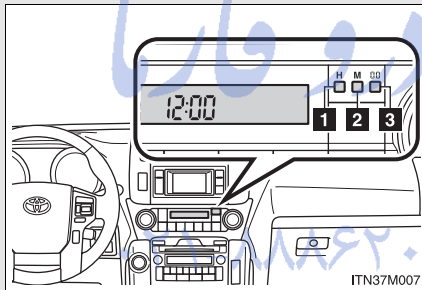

- 1 Adjusts the hours
- 2 Adjusts the minutes
- 3 Rounds the nearest hour*
*:e.g. 1:00 to 1:29 → 1:00
1:30 to 1:59 → 2:00

3

Interior features

■ The clock is displayed when

Vehicles without a smart entry & start system

The engine switch is in the "ACC" or "ON" position.

Vehicles with a smart entry & start system

The "ENGINE START STOP" switch is in ACCESSORY or IGNITION ON mode.

■ When disconnecting and reconnecting battery terminals

The clock data will be reset.

3-7. Other interior features

Outside temperature display

The temperature display shows temperatures within the range of -40 °C (-40 °F) and 50 °C (122 °F).

Non-Optitron type meter (vehicles with an automatic transmission)

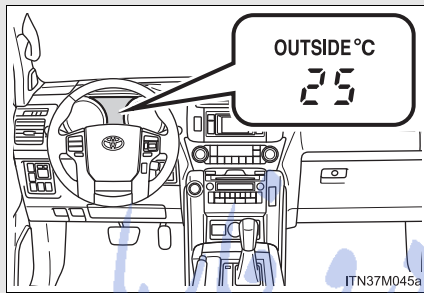

Non-Optitron type meter (vehicles with a manual transmission)

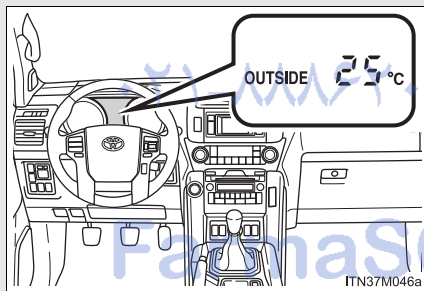

Optitron type meter

(→P. 283)

Accessory meter

(→P. 293)

■ **The outside temperature is displayed when**

Vehicles without a smart entry & start system

The engine switch is in the “ON” position.

Vehicles with a smart entry & start system

The “ENGINE START STOP” switch is in IGNITION ON mode.

■ **Display**

In the following situations, the correct outside temperature may not be displayed, or the display may take longer than normal to change:

- When the vehicle is stopped, or moving at low speeds (less than 20 km/h [12 mph])
- When the outside temperature has changed suddenly (at the entrance/exit of a garage, tunnel, etc.)

■ **When “-” or “E” is displayed**

The system may be malfunctioning. Take your vehicle to any authorized Toyota dealer or repairer, or another duly qualified and equipped professional.

تلفن شبانه روزی: ۰۲۱-۸۸۶۲۰۸۵

FarmaSOS.com

3-7. Other interior features

Ashtray*

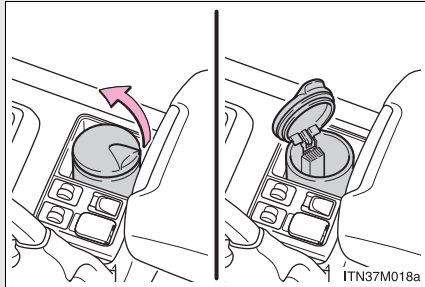

The ashtray can be installed in the auxiliary box (type D) (→P. 573) or cup holder (→P. 569).

⚠ CAUTION

■ When not in use

Keep the ashtray closed. In the event of sudden braking or sudden swerving, an accident may occur due to an occupant being struck by the open ashtray or ash flying out.

■ To prevent fire

- Fully extinguish matches and cigarettes before putting them in the ashtray, then make sure the ashtray is fully closed.
- Do not place paper or any other type of flammable object in the ashtray.

FarmaSOS.com

*: If equipped

3-7. Other interior features

Conversation mirror

The conversation mirror can provide the driver and the front passenger with a view of the rear seat area without the need to turn around.

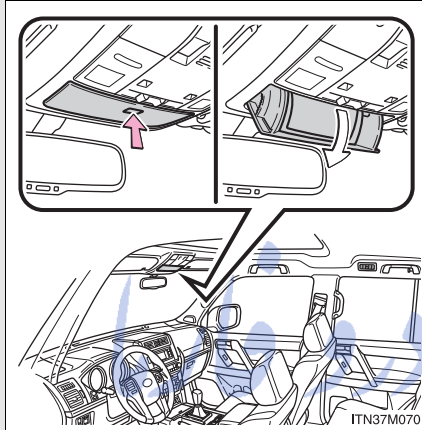

Press in the button.

- To use the overhead console from the conversation mirror state
Pull down the lid. (→P. 573)

FarmaSOS.com

3-7. Other interior features

Power outlet

The power outlet can be used for the following components:

12 V: Accessories that run on less than 10 A.

Accessories that run on less than 10 A should be used when using several power outlets at the same time.

220 VAC: Accessories that use less than 100 W.

Center of console (12 V)

Vehicles with an automatic transmission

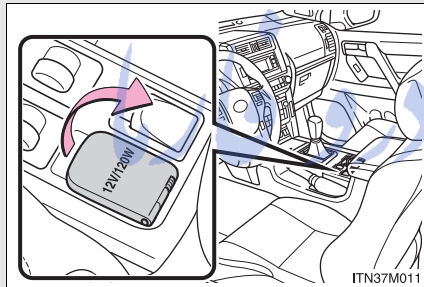

Vehicles with a manual transmission

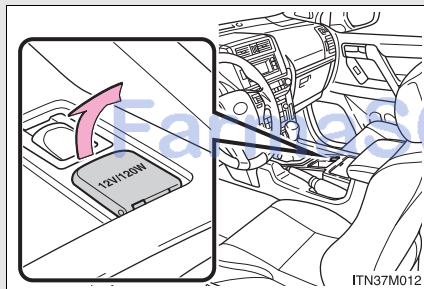

Rear of console box (12 V)

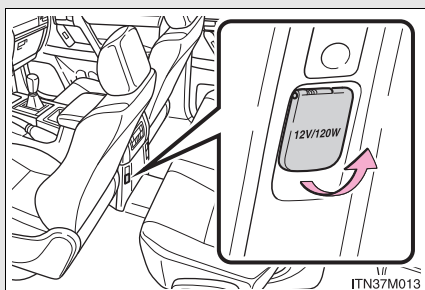

Luggage compartment (12 V) (if equipped)

3 door models

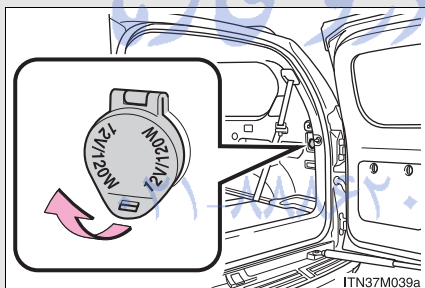

5 door models

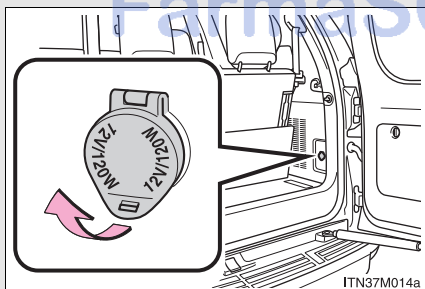

Luggage compartment (220 VAC) (if equipped)

3 door models

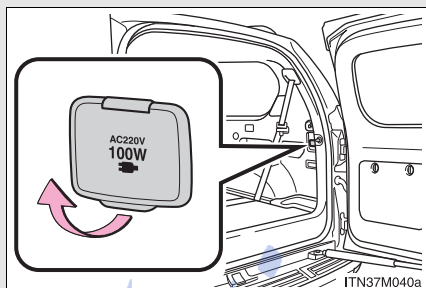

5 door models

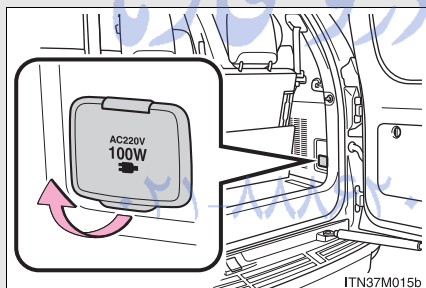

■ The power outlet can be used when

Vehicles without a smart entry & start system

12 V: The engine switch is in the “ACC” or “ON” position.

220 VAC: The engine switch is in the “ON” position.

Vehicles with a smart entry & start system

12 V: The “ENGINE START STOP” switch is in ACCESSORY or IGNITION ON mode.

220 VAC: The “ENGINE START STOP” switch is in IGNITION ON mode.

 NOTICE**■ To avoid damaging the power outlet**

Close the power outlet lid when the power outlet is not in use. Foreign objects or liquids that enter the power outlet may cause a short circuit.

■ To prevent blown fuse**12 V**

Do not use an accessory that uses more than 12 V 10 A.

220 VAC

Do not use a 220 VAC appliance that requires more than 100 W.

If a 220 VAC appliance that consumes more than 100 W is used, the protection circuit will cut the power supply.

■ To prevent battery discharge

Do not use the power outlet longer than necessary when the engine is not running.

■ Appliances that may not operate properly (220 VAC)

The following 220 VAC appliances may not operate properly even if their power consumption is under 100 W:

- Appliances with high initial peak wattage
- Measuring devices that process precise data
- Other appliances that require an extremely stable power supply

3-7. Other interior features

Seat heaters*

Vehicles with an automatic transmission

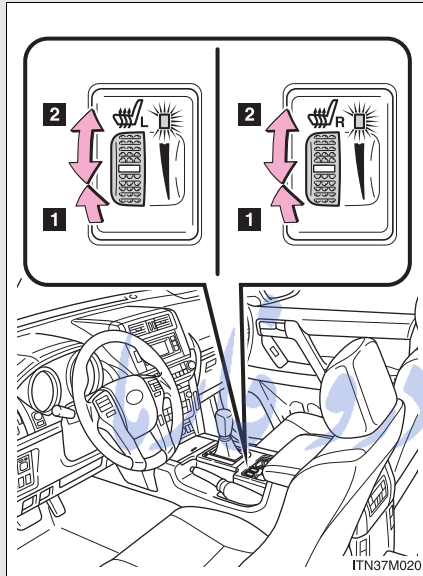

1 Turns the seat heater on

The indicator light comes on.

2 Adjusts the seat temperature

The further you turn the dial upward, the warmer the seat becomes.

تلفن شبانه روزی: ۰۲۱-۸۸۶۲۰۸۵

FarmaSOS.com

*: If equipped

Vehicles with a manual transmission

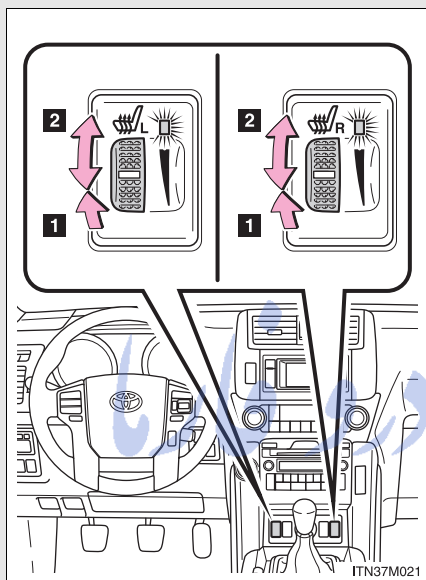

1 Turns the seat heater on

The indicator light comes on.

2 Adjusts the seat temperature

The further you turn the dial upward, the warmer the seat becomes.

3

Interior features

■ The seat heaters can be used when

Vehicles without a smart entry & start system

The engine switch is in the "ON" position.

Vehicles with a smart entry & start system

The "ENGINE START STOP" switch is in IGNITION ON mode.

■ When not in use

Turn the dial fully backward. The indicator light goes off.

 CAUTION

■ Burns

- Use caution when seating the following persons in a seat with the seat heater on to avoid the possibility of burns:
 - Babies, small children, the elderly, the sick and the physically challenged
 - Persons with sensitive skin
 - Persons who are fatigued
 - Persons who have taken alcohol or drugs that induce sleep (sleeping drugs, cold remedies, etc.)
- Do not cover the seat with anything when using the seat heater. Using the seat heater with a blanket or cushion increases the temperature of the seat and may lead to overheating.
- Do not use the seat heater more than necessary. Doing so may cause minor burns or overheating.

 NOTICE

■ To prevent seat heater damage

Do not put heavy objects that have an uneven surface on the seat and do not stick sharp objects (needles, nails, etc.) into the seat.

■ To prevent battery discharge

Turn the seat heaters off when the engine is not running.

3-7. Other interior features

Armrest*



 NOTICE
■ To prevent damage to the armrest Do not apply too much load on the armrest.

3

Interior features

تلفن شبانه روزی: ۰۲۱-۸۸۶۲۰۸۵

FarmaSOS.com

*: If equipped

3-7. Other interior features

Coat hooks

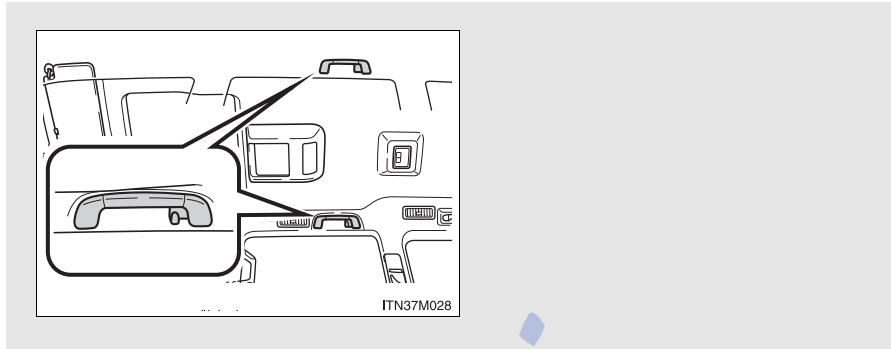

⚠ CAUTION

■ Items that cannot be hung on the coat hook (vehicles with SRS curtain shield airbags)

Do not hang coat hangers or other hard or sharp objects on the hook. If the SRS curtain shield airbags deploy, these items may become projectiles, causing death or serious injury.

تلفن شبانه روری: +۲۱ ۸۸۸۶۲۰۸۵

FarmaSOS.com

3-7. Other interior features

Assist grips

An assist grip (Type A) can be used to support your body while sitting on the seat.

An assist grip (Type B) can be used when getting in or out of the vehicle and others.

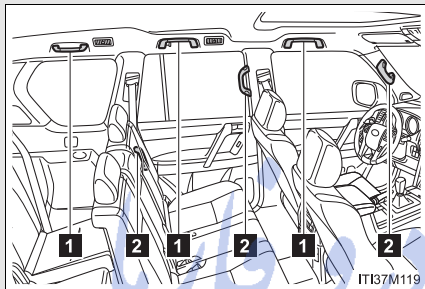

- 1 Assist grip (Type A)
- 2 Assist grip (Type B)

CAUTION

■ Assist grip (Type A)

Do not use the assist grip (Type A) when getting in or out of the vehicle or rising from your seat.

NOTICE

■ To prevent damage of the assist grip

Do not hang any heavy object or put a heavy load on the assist grip.

3-7. Other interior features

Floor mat

Use only floor mats designed specifically for vehicles of the same model and model year as your vehicle. Fix them securely in place onto the carpet.

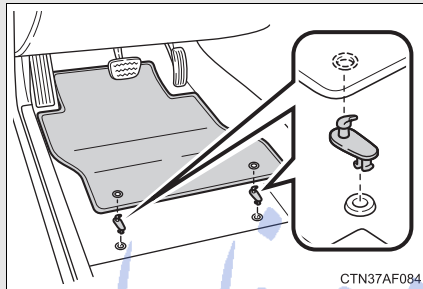

Fix the floor mat in place using the retaining hooks (clips) provided.

The shape of the retaining hooks (clips) and the fixing procedure of the floor mat for your vehicle may differ from those shown in the illustration. For details, refer to the floor mat retention clip installation instructions supplied with the clips.

CAUTION

Observe the following precautions.

Failure to do so may cause the driver's floor mat to slip, possibly interfering with the pedals while driving. An unexpectedly high speed may result or it may become difficult to stop the vehicle, leading to a serious accident.

■ When installing the driver's floor mat

- Do not use floor mats designed for other models or different model year vehicles, even if they are Toyota Genuine floor mats.
- Only use floor mats designed for the driver's seat.
- Always install the floor mat securely using the retaining hooks (clips) provided.
- Do not use two or more floor mats on top of each other.
- Do not place the floor mat bottom-side up or upside-down.

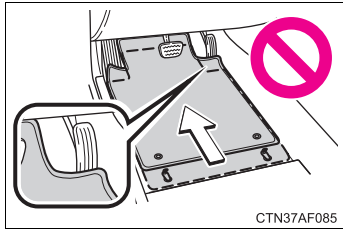
⚠ CAUTION**■ Before driving**

- Check that the floor mat is securely fixed in the correct place with all the provided retaining hooks (clips). Be especially careful to perform this check after cleaning the floor.
- With the engine stopped and the shift lever in P (automatic transmission) or N (manual transmission), fully depress each pedal to the floor to make sure it does not interfere with the floor mat.

امداد خودرو فارما

تلفن شبانه روزی: ۰۲۱-۸۸۶۲۰۸۵

FarmaSOS.com

3-7. Other interior features

Luggage compartment features

■ Deck rail (if equipped)

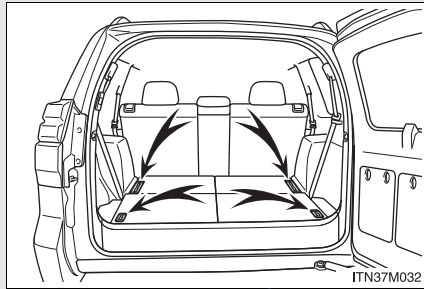

To attach the deck hooks, use the deck rails.

The deck hook itself is not included as an original equipment.

Vehicles with the third seats (power seat): When using the deck rail, the third seat must be fold down. (→P. 109)

■ Cargo hooks (if equipped)

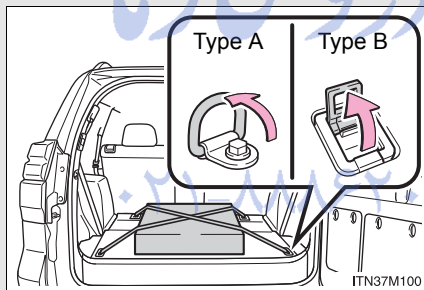

Raise the hook to use.

The cargo hooks are provided for securing loose items.

Vehicles with the third seats (manual seat): When using the deck hooks, the third seat must be fold down. (→P. 106)

FarmaSOS.com

■ Warning reflector holder

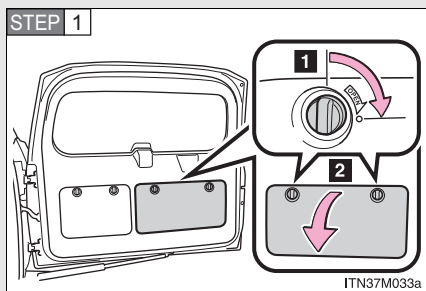

- 1 Turn the knob clockwise.
- 2 Open the lid.

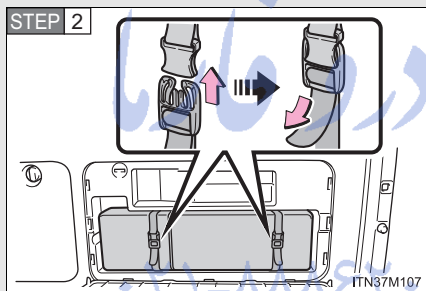

Secure the warning reflector.

The warning reflector itself is not included as an original equipment.

3

Interior features

FarmaSOS.com

■ **Cargo net hooks**

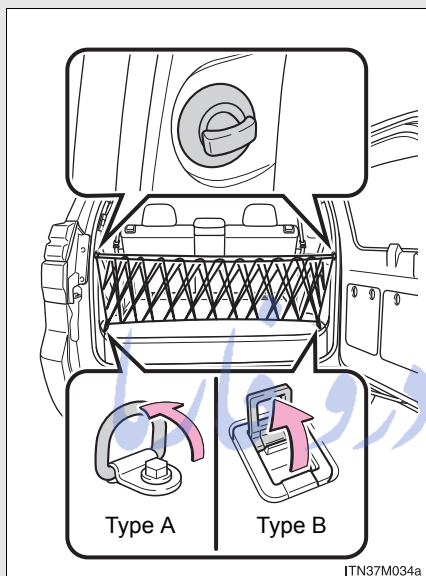

To hang the cargo net, use the cargo net hooks.

The cargo net itself is not included as an original equipment.

■ **Auxiliary box (if equipped)**

Type A

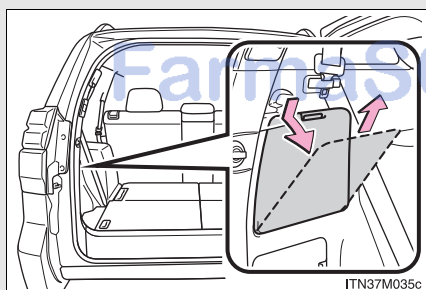

Remove the cover.

Type B

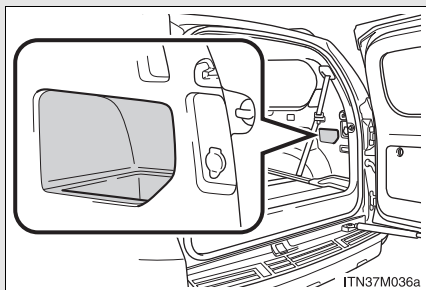

■ **Auxiliary tray (if equipped)**

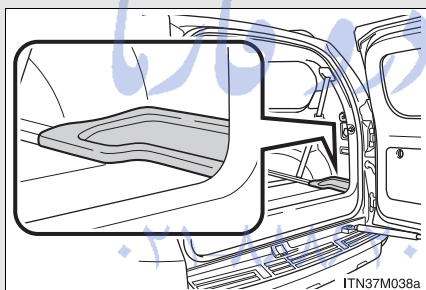

FarmaSOS.com

■ Luggage cover (if equipped)

3-doors models

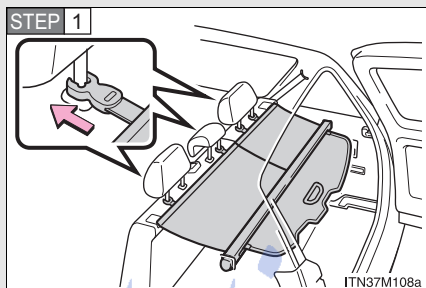

Attach the hooks to the head restraints.

5-doors models

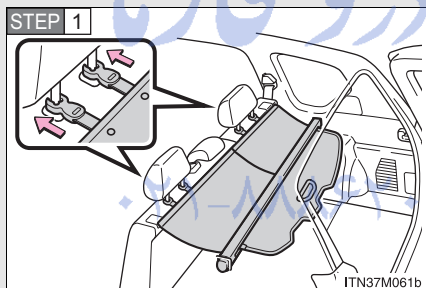

Attach the hooks to the head restraints.

Vehicles with the third seats:
When using the luggage cover,
the third seat must be fold
down. (→P. 106, 109)

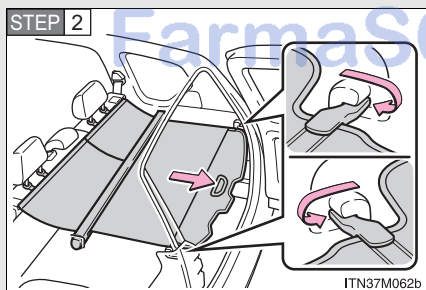

Pull out the luggage cover and
hook it on the anchors.

Removing the luggage cover

The luggage cover can be removed by following the procedure below.

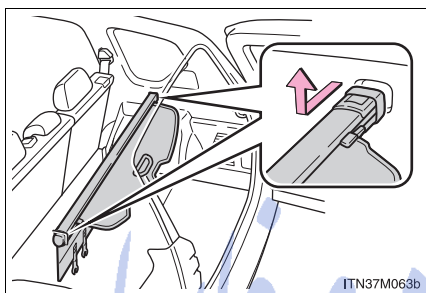

Retract the cover and release both ends, then lift it out.

After removing the luggage cover, place it somewhere other than the passenger compartment.

■ Adjusting the sub cover (if equipped)

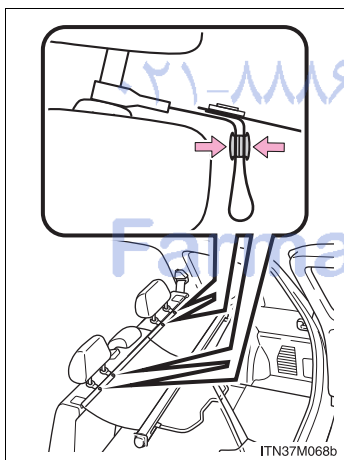

Fasten the button when the second seats are in the rear-most position.

Unfasten the buttons before sliding the second seats forward.

 CAUTION

■ **When the cargo hooks are not in use**

To avoid injury, always return the cargo hooks to their stowed positions.

■ **Caution while driving**

Keep the auxiliary box closed. In the event of sudden braking or sudden swerving, an accident may occur due to an occupant being struck by an open auxiliary box or the items stored inside.

■ **Caution for the luggage cover**

Do not allow children to climb on the luggage cover. Climbing on the luggage cover could result in damage to the luggage cover, possibly causing death or serious injury to the child.

امداد خودرو فارما
تلفن شبانه روزی: ۰۲۱-۸۸۶۲۰۸۵

FarmaSOS.com

4-1. Maintenance and care

- Cleaning and protecting the vehicle exterior 606
- Cleaning and protecting the vehicle interior 610

4-2. Maintenance

- Maintenance requirements..... 613

4-3. Do-it-yourself maintenance

- Do-it-yourself service precautions 617
- Hood 622
- Engine compartment..... 623
- Tires 645
- Tire inflation pressure 649
- Wheels..... 652
- Air conditioning filter 654
- Wireless remote control/electronic key battery..... 656
- Checking and replacing fuses 661
- Light bulbs 675

4-1. Maintenance and care

Cleaning and protecting the vehicle exterior

Perform the following to protect the vehicle and maintain it in prime condition:

- Working from top to bottom, liberally apply water to the vehicle body, wheel wells and underside of the vehicle to remove any dirt and dust.
- Wash the vehicle body using a sponge or soft cloth, such as a chamois.
- For hard-to-remove marks, use car wash soap and rinse thoroughly with water.
- Wipe away any water.
- Wax the vehicle when the waterproof coating deteriorates.

If water does not bead on a clean surface, apply wax when the vehicle body is cool.

■ Automatic car washes

- Fold the mirrors back before washing the vehicle. Start washing from the front of the vehicle. Make sure to extend the mirrors before driving.
- Brushes used in automatic car washes may scratch the vehicle surface and harm your vehicle's paint.

■ High pressure car washes

- Do not allow the nozzles of the car wash to come within close proximity of the windows and the air suspension unit.
- Before using the car wash, check that the fuel filler door on your vehicle is closed properly.

■ **Aluminum wheels**

- Remove any dirt immediately by using a neutral detergent. Do not use hard brushes or abrasive cleaners. Do not use strong or harsh chemical cleaners. Use the same mild detergent and wax as used on the paint.
- Do not use detergent on the wheels when they are hot, for example after driving for long distance in the hot weather.
- Wash detergent from the wheels immediately after use.

■ **Bumpers and side moldings**

Do not scrub with abrasive cleaners.

■ **Notes for vehicles with a smart entry & start system (if equipped)**

- If the door handle becomes wet while the electronic key is within the effective range, the door may lock and unlock repeatedly. Place the key in a position 2 m (6 ft.) or more separate from the vehicle while the vehicle is being washed. (Take care to ensure that the key is not stolen.)
- If the electronic key is inside the vehicle and a door handle becomes wet during a car wash, a message may be shown on the multi-information display and a buzzer will sound outside the vehicle. To turn off the alarm, lock all the doors.

تلفن شبانه روزی: ۰۲۱-۸۸۶۲۰۸۵

FarmaSOS.com

⚠ CAUTION

■ **When washing the vehicle**

Do not apply water to the inside of the engine compartment. Doing so may cause the electrical components etc. to catch fire.

■ **When cleaning the windshield (vehicles with rain-sensing windshield wiper)**

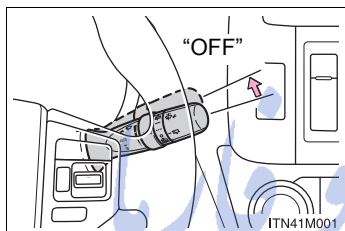

Set the wiper switch to off.

If the wiper switch is in "AUTO", the wipers may operate unexpectedly in the following situations, and may result in hands being caught or other serious injuries and cause damage to the wiper blades.

- When the upper part of the windshield where the raindrop sensor is located is touched by hand
- When a wet rag or similar is held close to the raindrop sensor
- If something bumps against the windshield
- If you directly touch the raindrop sensor body or if something bumps into the raindrop sensor

■ **Precautions regarding the exhaust pipe**

Exhaust gasses cause the exhaust pipe to become quite hot.

When washing the vehicle, be careful not to touch the pipe until it has cooled sufficiently, as touching a hot exhaust pipe can cause burns.

 NOTICE

■ **To prevent paint deterioration and corrosion on the body and components (aluminum wheels etc.)**

- Wash the vehicle immediately in the following cases:
 - After driving near the sea coast
 - After driving on salted roads
 - If coal tar or tree sap is present on the paint surface
 - If you see dead insects, insect droppings or bird droppings on the paint
 - After driving in an area contaminated with soot, oily smoke, mine dust, iron powder or chemical substances
 - If the vehicle becomes heavily soiled in dust or mud
 - If liquids such as benzene and gasoline are spilled on the paint surface
- If the paint is chipped or scratched, have it repaired immediately.
- To prevent the wheels from corroding, remove any dirt and store in a place with low humidity when storing wheels.

■ **Cleaning the exterior lights**

- Wash carefully. Do not use organic substances or scrub with a hard brush. This may damage the surfaces of the lights.
- Do not apply wax on the surfaces of the lights. Wax may cause damage to the lenses.

■ **To prevent damage to the windshield wiper arms**

When lifting the wiper arms away from the windshield, pull the driver side wiper arm upward first, and repeat for the passenger side. When returning the wipers to their original position, do so from the passenger side first.

■ **When using an automatic car wash (vehicles with rain sensing windshield wipers)**

Set the wiper switch to the off position.

If the wiper switch is in "AUTO", the wipers may operate and the wiper blades may be damaged.

4-1. Maintenance and care

Cleaning and protecting the vehicle interior

The following procedures will help protect your vehicle's interior and keep it in top condition:

■ Protecting the vehicle interior

Remove dirt and dust using a vacuum cleaner. Wipe dirty surfaces with a cloth dampened with lukewarm water.

■ Cleaning the leather areas

- Remove dirt and dust using a vacuum cleaner.
- Wipe any excess dirt and dust with a soft cloth dampened with diluted detergent.

Use a diluted water solution of approximately 5 % neutral wool detergent.

- Wring out any excess water from the cloth and thoroughly wipe off all remaining traces of detergent.
- Wipe the surface with a dry, soft cloth to remove any remaining moisture. Allow the leather to dry in a shaded ventilated area.

■ Cleaning the synthetic leather areas

- Remove loose dirt using a vacuum cleaner.
- Apply a mild soap solution to the synthetic leather using a sponge or soft cloth.
- Allow the solution to soak in for a few minutes. Remove the dirt and wipe off the solution with a clean, damp cloth.

■ Caring for leather areas

Toyota recommends cleaning the interior of the vehicle at least twice a year to maintain the quality of the vehicle's interior.

■ Shampooing the carpets

There are several commercial foaming-type cleaners available. Use a sponge or brush to apply the foam. Rub in overlapping circles. Do not use water. The excellent results are obtained when keeping the carpet as dry as possible.

■ Seat belts

Clean with mild soap and lukewarm water using a cloth or sponge. Also check the belts periodically for excessive wear, fraying or cuts.

⚠ CAUTION

■ Water in the vehicle

- Do not splash or spill liquid in the vehicle.
Doing so may cause electrical components etc. to malfunction or catch fire.
- Do not get any of the SRS components or wiring in the vehicle interior wet. (→P. 172)
An electrical malfunction may cause the airbags to deploy or not function properly, resulting in death or serious injury.

■ Cleaning the interior (especially instrument panel)

Do not use polish wax or polish cleaner. The instrument panel may reflect off the windshield, obstructing the driver's view and leading to an accident, resulting in death or serious injury.

 NOTICE

■ **Cleaning detergents**

- Do not use the following types of detergent, as they may discolor the vehicle interior or cause streaks or damage to painted surfaces:
 - Non-seat portions: Organic substances such as benzene or gasoline, alkaline or acidic solutions, dye, and bleach
 - Seats: Alkaline or acidic solutions, such as thinner, benzene, and alcohol
- Do not use polish wax or polish cleaner. The instrument panel's or other interior part's painted surface may be damaged.

■ **Preventing damage to leather surfaces**

Observe the following precautions to avoid damage to and deterioration of leather surfaces:

- Remove any dust or dirt from leather surfaces immediately.
- Do not expose the vehicle to direct sunlight for extended periods of time. Park the vehicle in the shade, especially during summer.
- Do not place items made of vinyl, plastic, or containing wax on the upholstery, as they may stick to the leather surface if the vehicle interior heats up significantly.

■ **Water on the floor**

Do not wash the vehicle floor with water.

Vehicle systems such as the audio system may be damaged if water comes into contact with electrical components such as the audio system above or under the floor of the vehicle. Water may also cause the body to rust.

■ **Cleaning the inside of the rear window**

- Do not use glass cleaner to clean the rear window, as this may cause damage to the rear window defogger heater wires or antenna. Use a cloth dampened with lukewarm water to gently wipe the window clean. Wipe the window in strokes running parallel to the heater wires or antenna.
- Be careful not to scratch or damage the heater wires or antenna.

4-2. Maintenance

Maintenance requirements

To ensure safe and economical driving, day-to-day care and regular maintenance is essential. Toyota recommends performing the following maintenance:

■ Scheduled maintenance

Scheduled maintenance should be performed at specified intervals according to the maintenance schedule.

For full details of your maintenance schedule, read the “Toyota Service Booklet” or “Toyota Warranty Booklet”.

■ Do-it-yourself maintenance

What about do-it-yourself maintenance?

Many maintenance items are easy to do yourself if you have a little mechanical ability and a few basic automotive tools.

Note, however, that some maintenance tasks require special tools and skills. These are best performed by qualified technicians. Even if you're an experienced do-it-yourself mechanic, we recommend that repairs and maintenance be conducted by any authorized Toyota dealer or repairer, or another duly qualified and equipped professional. Any authorized Toyota dealer or repairer will keep a record of maintenance, which could be useful should you ever require Warranty Service. Should you choose to select a qualified and equipped professional other than an authorized Toyota repairer to service or maintain your vehicle, we recommend that you request that a record of maintenance be kept.

■ **Where to go for service?**

In order to maintain your vehicle in the highest possible condition, Toyota recommends that all repairs and service operations be carried out by authorized Toyota dealers or repairers or other duly qualified and equipped professionals. For repairs and services covered by your warranty, please visit an authorized Toyota dealer or repairer, who will use genuine Toyota parts in repairing any difficulties you may encounter. There can also be advantages in utilizing authorized Toyota dealers or repairers for non-warranty repairs and services, as members of the Toyota network will be able to expertly assist you with any difficulties you may encounter.

Your Toyota dealer or repairer, or another duly qualified and equipped professional service department will perform all of the scheduled maintenance on your vehicle reliably and economically due to their experience with Toyota vehicles.

تلفن شبانه روزی: ۰۲۱-۸۸۸۶۲۰۸۵

FarmaSOS.com

■ Does your vehicle need repair?

Be on the alert for changes in performance and sounds, and visual tip-offs that indicate service is needed. Some important clues are:

- Engine missing, stumbling, or pinging
- Appreciable loss of power
- Strange engine noises
- A fluid leak under the vehicle (However, water dripping from the air conditioning after use is normal.)
- Change in exhaust sound (This may indicate a dangerous carbon monoxide leak. Drive with the windows open and have the exhaust system checked immediately.)
- Flat-looking tires, excessive tire squeal when cornering, uneven tire wear
- Vehicle pulls to one side when driving straight on a level road
- Strange noises related to suspension movement
- Loss of brake effectiveness, spongy feeling brake pedal, pedal almost touches the floor, vehicle pulls to one side when braking
- Engine coolant temperature continually higher than normal

If you notice any of these clues, take your vehicle to any authorized Toyota dealer or repairer, or another duly qualified and equipped professional, as soon as possible. Your vehicle may need adjustment or repair.

FarmaSOS.com

 CAUTION

■ **If your vehicle is not properly maintained**

Improper maintenance could result in serious damage to the vehicle and possible serious injury or death.

■ **Handling of the battery**

Battery posts, terminals and related accessories contain lead and lead compounds which are known to cause brain damage. Wash your hands after handling. (→P. 636)

امداد خودرو فارما

تلفن شبانه روزی: ۰۲۱-۸۸۸۶۲۰۸۵

FarmaSOS.com

4-3. Do-it-yourself maintenance

Do-it-yourself service precautions

If you perform maintenance yourself, be sure to follow the correct procedures as given in these sections.

Items	Parts and tools
Battery condition (→P. 636)	<ul style="list-style-type: none">• Warm water• Baking soda• Grease• Conventional wrench (for terminal clamp bolts)
Engine coolant level (→P. 632)	<ul style="list-style-type: none">• "Toyota Super Long Life Coolant" or similar high quality ethylene glycol based non-silicate, non-amine, non-nitrite and non-borate coolant with long-life hybrid organic acid technology. "Toyota Super Long Life Coolant" is pre-mixed with 50 % coolant and 50 % deionized water.• Funnel (used only for adding coolant)

FarmaSOS.com

4

Maintenance and care

4-3. Do-it-yourself maintenance

Items	Parts and tools
Engine oil level (→P. 627)	<ul style="list-style-type: none"> • “Toyota Genuine Motor Oil” or equivalent • Rag or paper towel • Funnel (used only for adding engine oil)
Fuses (→P. 661)	<ul style="list-style-type: none"> • Fuse with same amperage rating as original
Light bulbs (→P. 675)	<ul style="list-style-type: none"> • Bulb with same number and wattage rating as original • Phillips-head screwdriver • Flathead screwdriver • Wrench
Radiator, condenser and inter-cooler (→P. 635)	—
Tire inflation pressure (→P. 649)	<ul style="list-style-type: none"> • Tire pressure gauge • Compressed air source
Washer fluid (→P. 641)	<ul style="list-style-type: none"> • Water or washer fluid containing antifreeze (for winter use) • Funnel (used only for adding water or washer fluid)

⚠ CAUTION

The engine compartment contains many mechanisms and fluids that may move suddenly, become hot, or become electrically energized. To avoid death or serious injury, observe the following precautions:

■ **When working on the engine compartment:**

- Keep hands, clothing, and tools away from the moving fan and engine drive belt.
- Be careful not to touch the engine, radiator, exhaust manifold, etc. right after driving as they may be hot. Oil and other fluids may also be hot.
- Do not leave anything that may burn easily, such as paper or rags, in the engine compartment.
- Do not smoke, cause sparks or expose an open flame to fuel or the battery. Fuel and battery fumes are flammable.
- Be extremely cautious when working on the battery. It contains poisonous and corrosive sulfuric acid.
- Take care because brake fluid can harm your hands or eyes and damage painted surfaces.
If fluid gets on your hands or in your eyes, flush the affected area with clean water immediately.
If you still experience discomfort, consult a doctor.

 CAUTION

■ **When working near the electric cooling fans or radiator grille**

Vehicles without a smart entry & start system: Be sure the engine switch is off. With the engine switch in the “ON” position, the electric cooling fans may automatically start to run if the air conditioning is on and/or the coolant temperature is high. (→P. 635)

Vehicles with a smart entry & start system: Be sure the “ENGINE START STOP” switch is off. With the “ENGINE START STOP” switch in IGNITION ON mode, the electric cooling fans may automatically start to run if the air conditioning is on and/or the coolant temperature is high. (→P. 635)

■ **When working on or under the vehicle**

Do not get under the vehicle with just the jack supporting it.
Always use automotive jack stands or other solid supports.

■ **Safety glasses**

Wear safety glasses to prevent flying or falling material, fluid spray, etc. from getting in your eyes.

تلفن شبانه روزی: ۰۲۱-۸۸۶۲۰۸۵

FarmaSOS.com

 NOTICE

■ **If you remove the air cleaner filter**

Driving with the air cleaner filter removed may cause excessive engine wear due to dirt in the air.

■ **If the fluid level is low or high**

It is normal for the brake fluid level to go down slightly as the brake pads wear or when the fluid level in the accumulator is high.

If the reservoir needs frequent refilling, it may indicate a serious problem.

امداد خودرو فارما

تلفن شبانه روزی: ۰۲۱-۸۸۸۶۲۰۸۵

FarmaSOS.com

4-3. Do-it-yourself maintenance

Hood

Release the lock from the inside of the vehicle to open the hood.

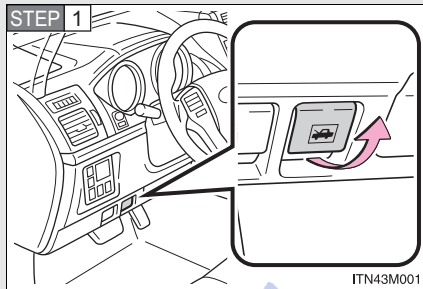

Pull the hood release lever.

The hood will pop up slightly.

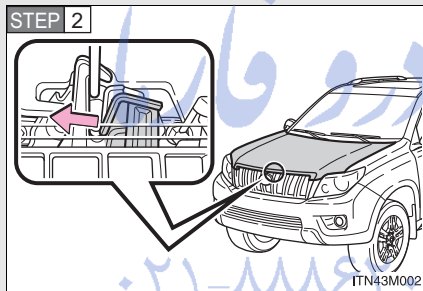

Move the auxiliary catch lever to side direction and lift the hood.

⚠ CAUTION

■ Pre-driving check

Check that the hood is fully closed and locked.

If the hood is not locked properly, it may open while the vehicle is in motion and cause an accident, which may result in death or serious injury.

4-3. Do-it-yourself maintenance Engine compartment

2TR-FE engine

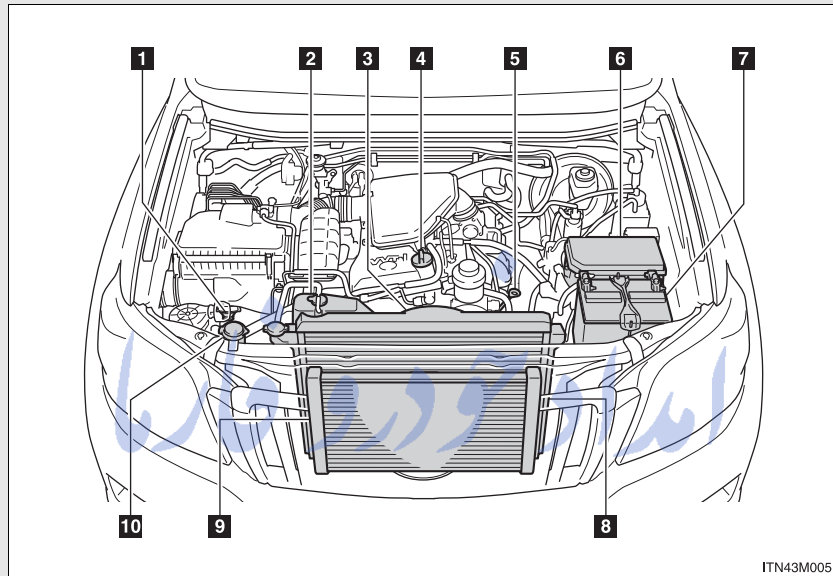

- | | |
|--|---|
| 1 Discharging dust valve
(→P. 644) | 5 Engine oil level dipstick
(→P. 627) |
| 2 Engine coolant reservoir
(→P. 632) | 6 Fuse box
(→P. 661) |
| 3 Cooling fan | 7 Battery
(→P. 636) |
| 4 Engine oil filler cap
(→P. 629) | 8 Radiator
(→P. 635) |
| | 9 Condenser
(→P. 635) |
| | 10 Washer fluid tank (→P. 641) |

4

Maintenance and care

1GR-FE engine

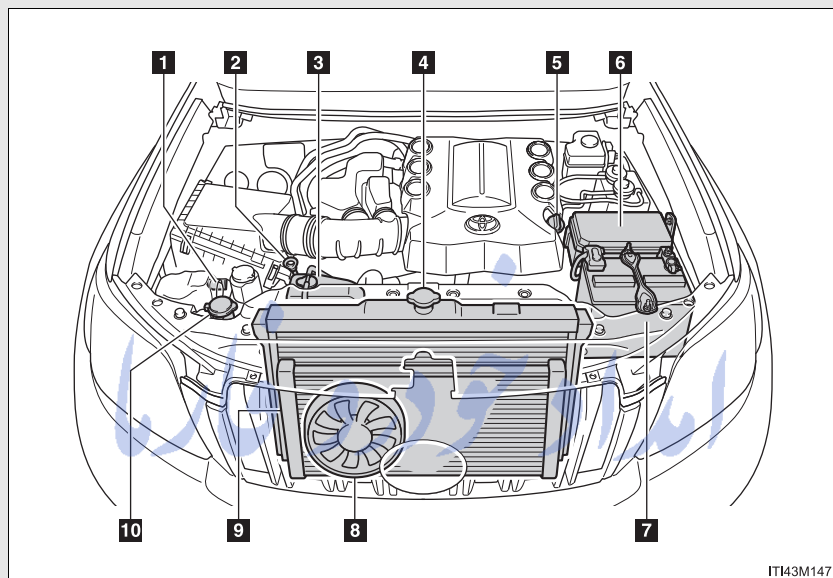

- | | |
|--|---|
| 1 Discharging dust valve
(if equipped) (→P. 644) | 5 Engine oil filler cap
(→P. 629) |
| 2 Engine oil level dipstick
(→P. 627) | 6 Fuse box (→P. 661) |
| 3 Engine coolant reservoir
(→P. 632) | 7 Battery (→P. 636) |
| 4 Radiator (→P. 635) | 8 Cooling fan |
| | 9 Condenser (→P. 635) |
| | 10 Washer fluid tank (→P. 641) |

1KD-FTV engine

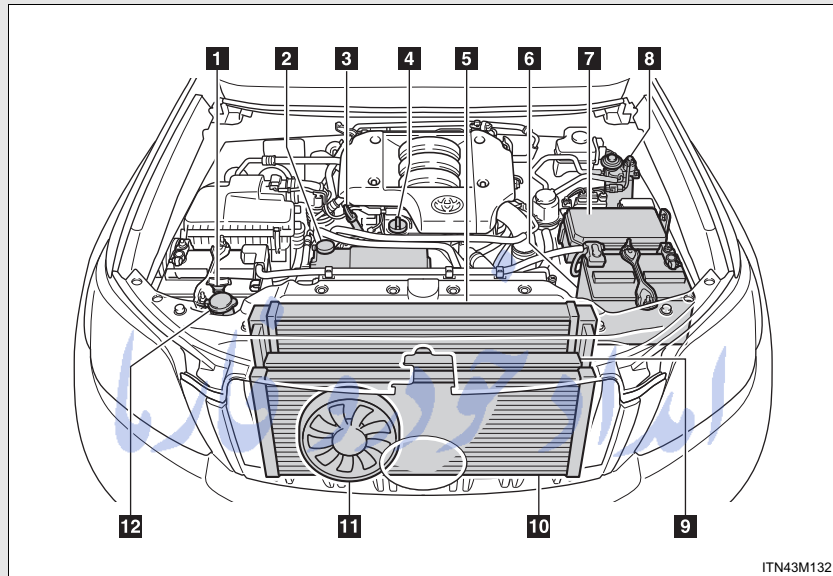

ITN43M132

- | | |
|---|--|
| 1 Discharging dust valve
(→P. 644) | 5 Radiator
(→P. 635) |
| 2 Engine coolant reservoir
(→P. 632) | 6 Battery
(→P. 636) |
| 3 Engine oil level dipstick
(→P. 627) | 7 Fuse box
(→P. 661) |
| 4 Engine oil filler cap
(→P. 629) | 8 Fuel filter
(→P. 643, 806) |
| | 9 Intercooler
(→P. 635) |
| | 10 Condenser
(→P. 635) |
| | 11 Cooling fan |
| | 12 Washer fluid tank (→P. 641) |

Engine compartment cover

■ Removing the engine compartment cover

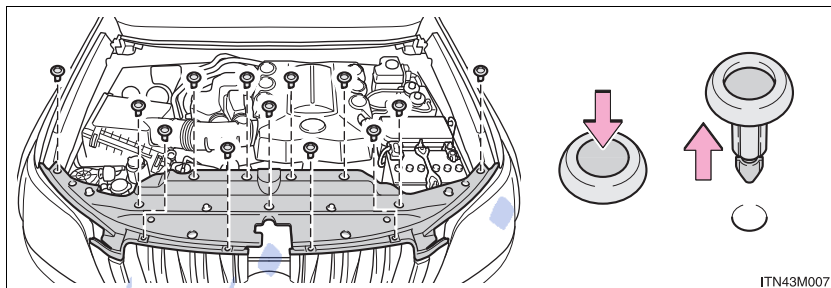

■ Installing the clips

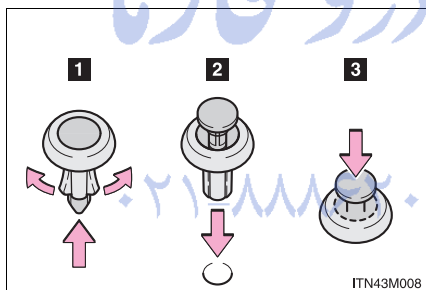

Engine oil

With the engine at operating temperature and turned off, check the oil level on the dipstick.

■ Checking the engine oil

STEP 1 Park the vehicle on level ground. After turning off the engine, wait more than five minutes for the oil to drain back into the bottom of the engine.

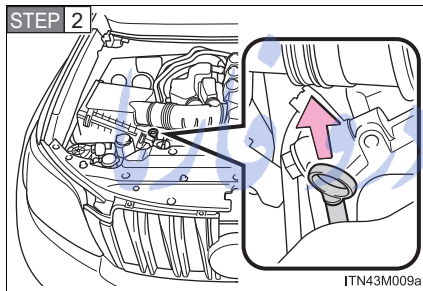

Holding a rag under the end, pull the dipstick out.

STEP 3 Wipe the dipstick clean.

STEP 4 Reinsert the dipstick fully.

STEP 5 Holding a rag under the end, pull the dipstick out and check the oil level.

STEP 6 Wipe the dipstick and reinsert it fully.

4-3. Do-it-yourself maintenance

Type A

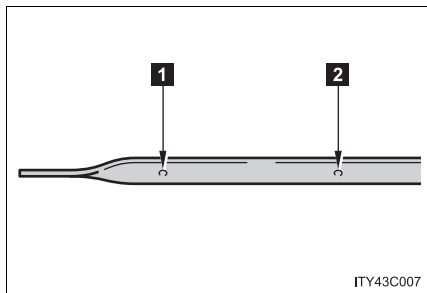

- 1** Low
- 2** Full

Type B

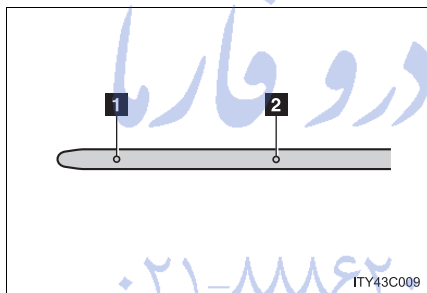

- 1** Low
- 2** Full

Type C

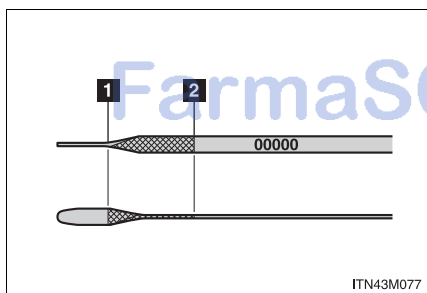

- 1** Low
- 2** Full

■ Adding engine oil

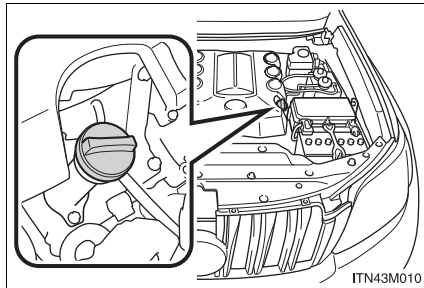

If the oil level is below or near the low level mark, add engine oil of the same type as already in the engine.

Make sure to check the oil type and prepare the items needed before adding oil.

Engine oil selection	→P. 819	
Oil quantity (Low → Full)	1GR-FE engine	1.7 L (1.8 qt., 1.5 Imp.qt.)
	1KD-FTV and 2TR-FE engines	1.3 L (1.4 qt., 1.1 Imp.qt.)
Items	Clean funnel	

STEP 1 Remove the oil filler cap by turning it counterclockwise.

STEP 2 Add engine oil slowly, checking the dipstick.

STEP 3 Install the oil filler cap by turning it clockwise.

■ Engine oil consumption

- The amount of engine oil consumed depends on the oil viscosity, the quality of the oil and the way the vehicle is driven.
- More oil is consumed under driving conditions such as high speeds and frequent acceleration and deceleration.
- A new engine consumes more oil.
- When judging the amount of oil consumption, keep in mind that the oil may have become diluted, making it difficult to judge the true level accurately.
- Oil consumption: Max. 1.0 L per 1000 km (1.1 qt./600 miles, 0.9 Imp.qt./600 miles)
- If you consume more than 1.0 L (1.1 qt., 0.9 Imp.qt.) every 1000 km (600 miles), contact any authorized Toyota dealer or repairer, or another duly qualified and equipped professional.

■ After changing the engine oil (diesel engine only)

The oil maintenance data should be reset. Perform the following procedures:

- STEP 1** Switch the display to the trip meter "A" when the engine is running. (→P. 268)
- STEP 2** Turn the "ENGINE START STOP" switch OFF.
- STEP 3** While pressing the "ODO TRIP" button (→P. 268), set the "ENGINE START STOP" switch to IGNITION ON mode (but do not start the engine because otherwise the reset mode will be cancelled). Continue to press and hold the button until the multi-information display indicates that the reset is complete.

⚠ CAUTION**■ Used engine oil**

- Used engine oil contains potentially harmful contaminants which may cause skin disorders such as inflammation or skin cancer, so care should be taken to avoid prolonged and repeated contact. To remove used engine oil from your skin, wash thoroughly with soap and water.
- Dispose of used oil and filters only in a safe and acceptable manner. Do not dispose of used oil and filters in household trash, in sewers or onto the ground. Call any authorized Toyota dealer or repairer, or another duly qualified and equipped professional, service station or auto parts store for information concerning recycling or disposal.
- Do not leave used engine oil within the reach of children.

⚠ NOTICE**■ To prevent serious engine damage**

Check the oil level on regular basis.

■ When replacing the engine oil

- Be careful not to spill engine oil on the vehicle components.
- Avoid overfilling, or the engine could be damaged.
- Check the oil level on the dipstick every time you refill the vehicle.
- Be sure the engine oil filler cap is properly tightened.

Engine coolant

Gasoline engine

The coolant level is satisfactory if it is between the “F” and “L” lines on the reservoir when the engine is cold.

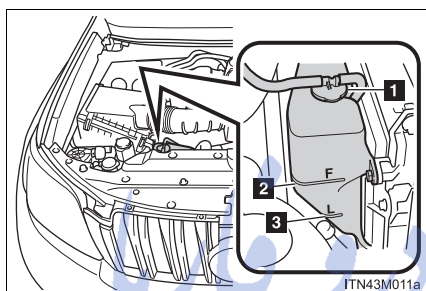

1 Reservoir cap

2 “F” line

3 “L” line

If the level is on or below the “L” line, add coolant up to the “F” line.

Diesel engine

The coolant level is satisfactory if it is between the “FULL” and “LOW” lines on the reservoir when the engine is cold.

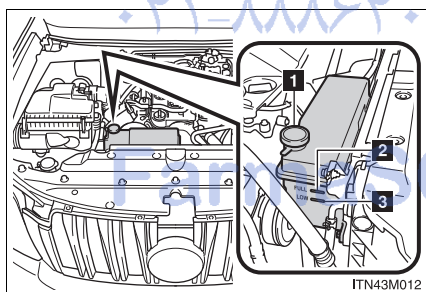

1 Reservoir cap

2 “FULL” line

3 “LOW” line

If the level is on or below the “LOW” line, add coolant up to the “FULL” line.

■ Coolant selection

Only use “Toyota Super Long Life Coolant” or a similar high quality ethylene glycol based non-silicate, non-amine, non-nitrite, and non-borate coolant with long-life hybrid organic acid technology.

“Toyota Super Long Life Coolant” is a mixture of 50 % coolant and 50 % deionized water. (Enabled: -35 °C [-31 °F])

For more details about engine coolant, contact any authorized Toyota dealer or repairer, or another duly qualified and equipped professional.

■ If the coolant level drops within a short time of replenishing

Visually check the radiator, hoses, engine coolant reservoir caps, drain cock and water pump.

If you cannot find a leak, have any authorized Toyota dealer or repairer, or another duly qualified and equipped professional, test the cap and check for leaks in the cooling system.

⚠ CAUTION

■ When the engine is hot

Do not remove the radiator cap, or the coolant reservoir cap.

The cooling system may be under pressure and may spray hot coolant if the cap is removed, causing burns or other injuries.

 NOTICE

■ **When adding coolant**

Coolant is neither plain water nor straight antifreeze. The correct mixture of water and antifreeze must be used to provide proper lubrication, corrosion protection and cooling. Be sure to read the antifreeze or coolant label.

■ **If you spill coolant**

Be sure to wash it off with water to prevent it from damage to parts or paint.

امداد خودرو فارما

تلفن شبانه روزی: ۰۲۱-۸۸۸۶۲۰۸۵

FarmaSOS.com

Radiator, condenser and intercooler

Check the radiator, condenser and intercooler and clear any foreign objects.

If any of the above parts are extremely dirty or you are not sure of their condition, have your vehicle inspected by any authorized Toyota dealer or repairer, or another duly qualified and equipped professional.

CAUTION

■ When the engine is hot







Do not touch the radiator, condenser or intercooler as they may be hot and cause burns.

Battery

Check the battery as follows.

■ Caution symbols

The meanings of each caution symbol on the top of the battery are as follows:

	No smoking, no naked flames, no sparks		Battery acid
	Shield eyes		Note operating instructions
	Keep away from children		Explosive gas

■ Battery exterior

Make sure that the battery terminals are not corroded and that there are no loose connections, cracks, or loose clamps.

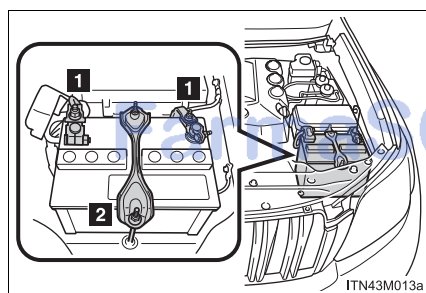

1 Terminals

2 Hold-down clamp

■ **Checking battery fluid**

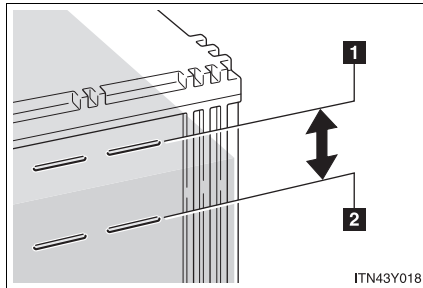

Check that the level is between the "UPPER" and "LOWER" lines.

- 1 "UPPER LEVEL" line
- 2 "LOWER LEVEL" line

If the fluid level is at or below the "LOWER" line, add distilled water.

■ **Adding distilled water**

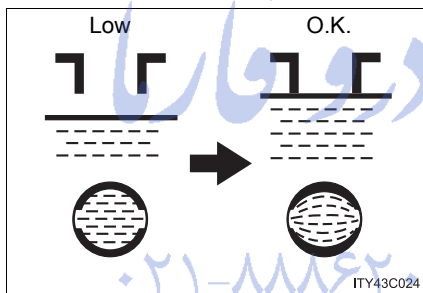

STEP 1 Remove the vent plug.

STEP 2 Add distilled water.

If the "UPPER" line cannot be seen, check the fluid level by looking directly at the cell.

STEP 3 Put the vent plug back on and close securely.

■ **Before recharging**

When recharging, the battery produces hydrogen gas which is flammable and explosive. Therefore, observe the following before recharging:

- If recharging with the battery installed on the vehicle, be sure to disconnect the ground cable.
- Make sure the power switch on the charger is off when connecting and disconnecting the charger cables to the battery.

■ **After recharging/reconnecting the battery (vehicles with a smart entry & start system)**

The engine may not start. Follow the procedure below to initialize the system.

STEP 1 Shift the shift lever to P (automatic transmission) or depress the brake pedal with the shift lever in N (manual transmission).

STEP 2 Open and close any of the doors.

STEP 3 Restart the engine.

- Unlocking the doors using the smart entry & start system may not be possible immediately after reconnecting the battery. If this happens, use the wireless remote control or the mechanical key to lock/unlock the doors.
- Start the engine with the “ENGINE START STOP” switch in ACCESSORY mode. The engine may not start with the “ENGINE START STOP” switch turned OFF. However, the engine will operate normally from the second attempt.

- The “ENGINE START STOP” switch mode is recorded by the vehicle. If the battery is reconnected, the vehicle will return the “ENGINE START STOP” switch mode to the status it was in before the battery was disconnected. Make sure to turn off the engine before disconnect the battery. Take extra care when connecting the battery if the “ENGINE START STOP” switch mode prior to discharge is unknown.

If the system will not start even after multiple attempts, contact any authorized Toyota dealer or repairer or duly qualified and equipped professional.

⚠ CAUTION

■ Chemicals in the battery

Batteries contain poisonous and corrosive sulfuric acid and may produce hydrogen gas which is flammable and explosive. To reduce the risk of death or serious injury, take the following precautions while working on or near battery:

- Do not cause sparks by touching the battery terminals with tools.
- Do not smoke or light a match near the battery.
- Avoid contact with eyes, skin and clothes.
- Never inhale or swallow electrolyte.
- Wear protective safety glasses when working near the battery.
- Keep children away from the battery.

■ Where to safely charge the battery

Always charge the battery in an open area. Do not charge the battery in a garage or closed room where there is not sufficient ventilation.

 CAUTION

■ **Emergency measures regarding electrolyte**

- If electrolyte gets in your eyes
Flush your eyes with clean water for at least 15 minutes and get immediate medical attention. If possible, continue to apply water with a sponge or cloth while traveling to the nearest medical facility.
- If electrolyte gets on your skin
Wash the affected area thoroughly. If you feel pain or burning, get medical attention immediately.
- If electrolyte gets on your clothes
It can soak through clothing on to your skin. Immediately take off the clothing and follow the procedure above if necessary.
- If you accidentally swallow electrolyte
Drink a large quantity of water or milk. Follow with milk of magnesia, beaten raw egg or vegetable oil. Get emergency medical attention immediately.

 NOTICE تلفن شبانه روزی: ۸۵+۸۸۶۲۰۲۱

■ **When recharging the battery**

Never recharge the battery while the engine is running. Also, be sure all accessories are turned off.

■ **When adding distilled water**

Avoid overfilling. Water spilled during battery recharging may cause corrosion.

Washer fluid

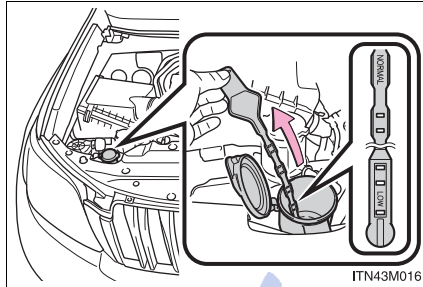

If the washer fluid level is at “LOW”, add washer fluid.

■ Using the gauge

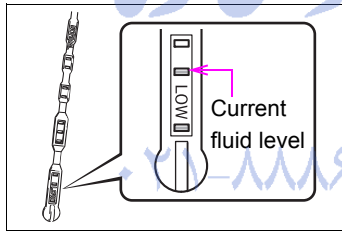

The washer fluid level is checked by observing the position of the level on the liquid covered holes in the gauge.

If the level falls below the second hole from the bottom (“LOW” position), refill the washer fluid.

 CAUTION

■ **When adding washer fluid**

Do not add washer fluid when the engine is hot or running as washer fluid contains alcohol and may catch fire if spilled on the engine etc.

 NOTICE

■ **Do not use any fluid other than washer fluid**

Do not use soapy water or engine antifreeze instead of washer fluid. Doing so may cause streaking on the vehicle's painted surfaces.

■ **Diluting washer fluid**

Dilute washer fluid with water as necessary. Refer to the freezing temperatures listed on the label of the washer fluid bottle.

تلفن شبانه روزی: ۰۲۱-۸۸۶۲۰۸۵

FarmaSOS.com

Draining the fuel filter water (diesel engine only)

The water in the fuel filter must be drained immediately if the following symptom occurs:

Vehicles with a non-optitron type meters

Type A

When the fuel filter warning light comes on.

Type B

When the fuel system warning light flashes and buzzer sounds.

Vehicles with an optitron type meters

When the warning message "DRAIN WATER FROM FUEL FILTER" appears on the instrument cluster and buzzer* sounds.

*: On some models

STEP 1 Remove the drain plug from the clamp and place a small tray to catch the water.

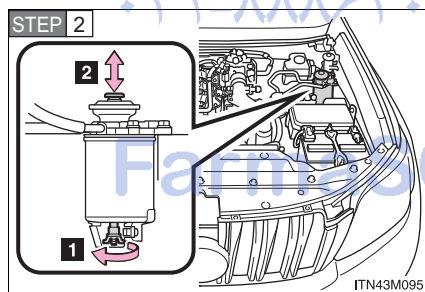

1 Turn the drain plug about 2-2-1/2 turns.

Loosening more than this will cause water oozing from around the drain plug.

2 Operate the priming pump until the fuel begins to run out.

STEP 3 After draining, retighten the drain plug. Do not use a tool.

Discharging dust valve (if equipped)

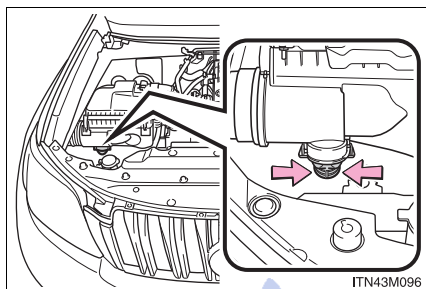

Squeeze the rubber cap to remove the dust if the discharging dust valve is dirty.

Shape of the valve differs slightly in accordance with the engine.

NOTICE

■ To prevent damaging the engine

Do not drive with the discharging dust valve removed. Doing so cause excessive engine wear.

تلفن شبانه روزی: ۰۲۱-۸۸۶۲۰۸۵

FarmaSOS.com

4-3. Do-it-yourself maintenance

Tires

Replace or rotate tires in accordance with maintenance schedules and treadwear.

■ Checking tires

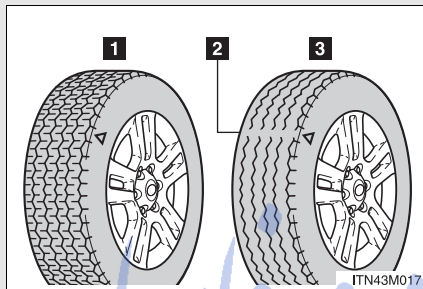

- 1 New tread
- 2 Treadwear indicator
- 3 Worn tread

The location of treadwear indicators is shown by the "TWI" or "△" marks, etc., molded on the sidewall of each tire.

Check spare tire condition and pressure if not rotated.

■ Tire rotation

Vehicles with a standard spare tire

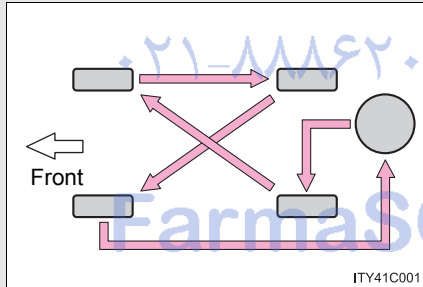

Rotate the tires in the order shown.

To equalize tire wear and help extend tire life, Toyota recommends that you rotate your tires approximately every 5000 km (3000 miles).

Vehicles with an emergency tire puncture repair kit

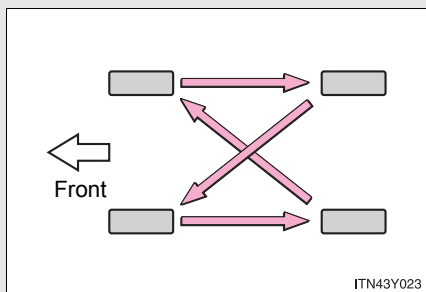

■ When to replace your vehicle's tires

Tires should be replaced if:

- You have tire damage such as cuts, splits, cracks deep enough to expose the fabric, and bulges indicating internal damage
- A tire goes flat repeatedly or cannot be properly repaired due to the size or location of a cut or other damage

If you are not sure, consult with any authorized Toyota dealer or repairer, or another duly qualified and equipped professional.

■ Tire life

Any tire over 6 years old must be checked by a qualified technician even if it has seldom or never been used or damage is not obvious.

■ If the tread on snow tires wears down below 4 mm (0.16 in.)

The effectiveness of the tires as snow tires is lost.

⚠ CAUTION**■ When inspecting or replacing tires**

Observe the following precautions to prevent accidents.
Failure to do so may cause damage to parts of the drive train as well as dangerous handling characteristics, which may lead to an accident resulting in death or serious injury.

- Do not mix tires of different makes, models or tread patterns.
Also, do not mix tires of remarkably different treadwear.
- Do not use tire sizes other than those recommended by Toyota.
- Do not mix differently constructed tires (radial, bias-belted or bias-ply tires).
- Do not mix summer, all season and snow tires.
- Do not use tires that have been used on another vehicle.
Do not use tires if you do not know how they were used previously.

تلفن شبانه روزی: ۰۲۱-۸۸۶۲۰۸۵

FarmaSOS.com

 NOTICE

■ **Driving on rough roads**

Take particular care when driving on roads with loose surfaces or potholes. These conditions may cause losses in tire inflation pressure, reducing the cushioning ability of the tires. In addition, driving on rough roads may cause damage to the tires themselves, as well as the vehicle's wheels and body.

■ **If tire inflation pressures become low while driving**

Do not continue driving, or your tires and/or wheels may be ruined.

■ **For vehicles with an emergency tire puncture repair kit (if equipped)**

Do not tow anything if a tire that has been repaired using the emergency tire puncture repair kit is installed. The load on the tire may cause unexpected damage to the tire.

تلفن شبانه روزی: ۰۲۱-۸۸۶۲۰۸۵

FarmaSOS.com

4-3. Do-it-yourself maintenance

Tire inflation pressure

Make sure to maintain the proper tire inflation pressure. Tire inflation pressure should be checked at least once per month. However, Toyota recommends that tire inflation pressure be checked once every two weeks. (→P. 840)

■ Effects of incorrect tire inflation pressure

Driving with incorrect tire inflation pressure may result in the following:

- Reduced fuel efficiency
- Reduced driving comfort and tire life
- Reduced safety
- Damage to the drive train

If a tire needs frequent inflating, have it checked by any authorized Toyota dealer or repairer, or another duly qualified and equipped professional.

تلفن شبانه روزی: ۰۲۱-۸۸۶۲۰۸۵

FarmaSOS.com

■ **Instructions for checking tire inflation pressure**

When checking tire inflation pressure, observe the following:

- Check only when the tires are cold.
If your vehicle has been parked for at least 3 hours and has not been driven for more than 1.5 km or 1 mile, you will get an accurate cold tire inflation pressure reading.
- Always use a tire pressure gauge.
The appearance of the tire can be misleading. In addition, tire inflation pressure that is even just a few pounds off can affect ride quality and handling.
- Do not reduce tire inflation pressure after driving. It is normal for tire inflation pressure to be higher after driving.
- Never exceed the vehicle capacity weight.
Passengers and luggage weight should be placed so that the vehicle is balanced.

تلفن شبانه روزی: ۰۲۱-۸۸۶۲۰۸۵

FarmaSOS.com

⚠ CAUTION**■ Proper inflation is critical to save tire performance**

Keep your tires properly inflated. Otherwise, the following conditions may occur and result in an accident causing death or serious injury:

- Excessive wear
- Uneven wear
- Poor handling
- Possibility of blowouts resulting from overheated tires
- Poor sealing of the tire bead
- Wheel deformation and/or tire separation
- A greater possibility of tire damage from road hazards

⚠ NOTICE**■ When inspecting and adjusting tire inflation pressure**

Be sure to put the tire valve caps back on. Without the valve caps, dirt or moisture could get into the valve and cause air leakage, which could result in an accident. If the caps are lost, replace them as soon as possible.

4-3. Do-it-yourself maintenance

Wheels

If a wheel is bent, cracked or heavily corroded, it should be replaced. Otherwise, the tire may separate from the wheel or cause loss of handling control.

■ Wheel selection

When replacing wheels, care should be taken to ensure that they are equivalent to those removed in load capacity, diameter, rim width, and inset*.

Replacement wheels are available at any authorized Toyota dealer or repairer, or another duly qualified and equipped professional.

*: Conventionally referred to as "offset".

Toyota does not recommend using the following:

- Wheels of different sizes or types
- Used wheels
- Bent wheels that have been straightened

■ Aluminum wheel precautions

- Use only Toyota wheel nuts and wrenches designed for use with your aluminum wheels.
- When rotating, repairing or changing your tires, check that the wheel nuts are still tight after driving 1600 km (1000 miles).
- Be careful not to damage the aluminum wheels when using tire chains.

- When balancing your wheels, use only Toyota genuine balance weights or the equivalent. If clip-on balance weights are being used, use a plastic or rubber hammer to install the weight.

⚠ CAUTION

■ **When replacing wheels**

- Do not use wheels that are a different size from those recommended in the Owner's Manual, as this may result in loss of handling control.
- Never use an inner tube in a leaking wheel which is designed for a tubeless tire. Doing so may result in an accident, causing death or serious injury.

■ **When installing the wheel nuts**

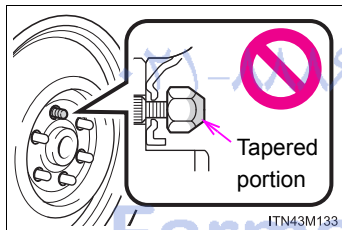

- Be sure to install the wheel nuts with the tapered end facing inward. Installing the nuts with the tapered end facing outward can cause wheel to break and eventually cause a wheel to come off while driving, which could lead to an accident resulting in death or serious injury.

- Never use oil or grease on the wheel bolts or wheel nuts. Oil and grease may cause the wheel nuts to be excessively tightened, leading to bolt or disc wheel damage. In addition, the oil or grease can cause the wheel nuts to loosen and the wheel may fall off, causing an accident and resulting in death or serious injury. Remove any oil or grease from the wheel bolts or wheel nuts.

4-3. Do-it-yourself maintenance

Air conditioning filter

The air conditioning filter must be changed regularly to maintain air conditioning efficiency.

■ Removal method

STEP 1 Turn the engine switch (vehicles without a smart entry & start system) or “ENGINE START STOP” switch (vehicles with a smart entry & start system) off.

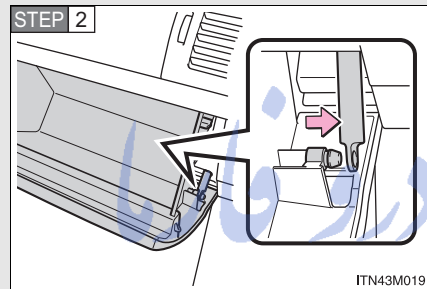

Open the glove box. Slide off the damper.

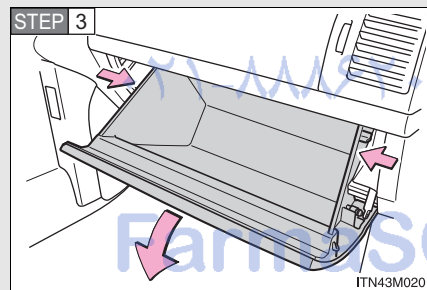

Push in each side of the glove box to disconnect the claws.

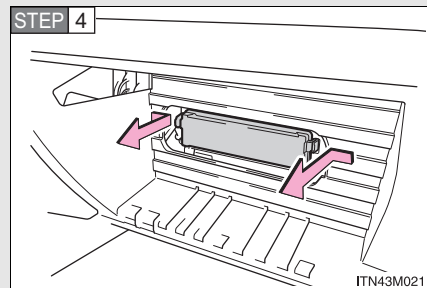

Remove the filter cover.

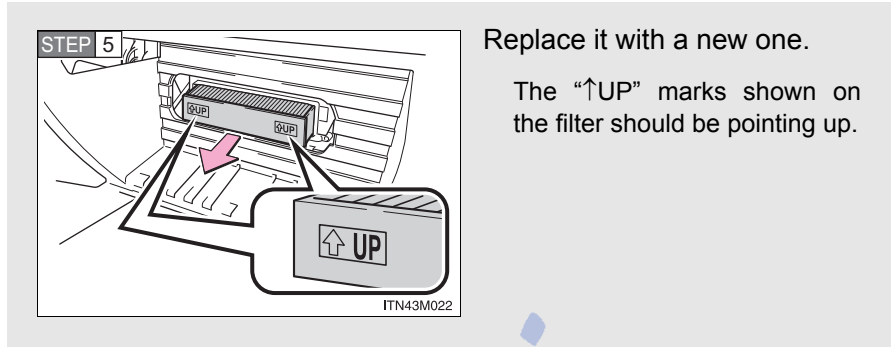

■ **Checking interval**

Replace the air conditioning filter according to the maintenance schedule. In dusty areas or areas with heavy traffic flow early replacement may be required. (For scheduled maintenance information, please refer to the “Toyota Service Booklet” or “Toyota Warranty Booklet”.)

■ **If air flow from the vents decreases dramatically**

The filter may be clogged. Check the filter and replace if necessary.

 **NOTICE**

■ **When using the air conditioning system**

Make sure that a filter is always installed.
Using the air conditioning system without a filter may cause damage to the system.

4-3. Do-it-yourself maintenance

Wireless remote control/electronic key battery

Replace the battery with a new one if it is depleted.

■ You will need the following items:

- Flathead screwdriver
- Lithium battery

Vehicles without a smart entry & start system (type A):
CR2032

Vehicles without a smart entry & start system (type B):
CR2016

Vehicles with a smart entry & start system: CR1632

■ Replacing the battery

Vehicles without a smart entry & start system (type A)

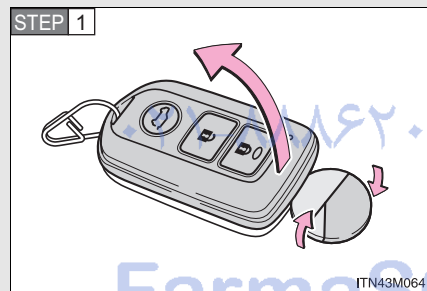

Remove the cover using a coin protected with tape etc.

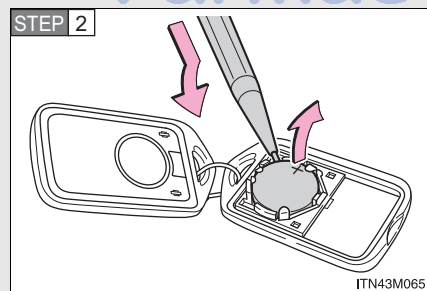

Remove the depleted battery using the tip of a ball-point pen or a similar pointed object.

Insert a new battery with the "+" terminal facing up.

Vehicles without a smart entry & start system (type B)

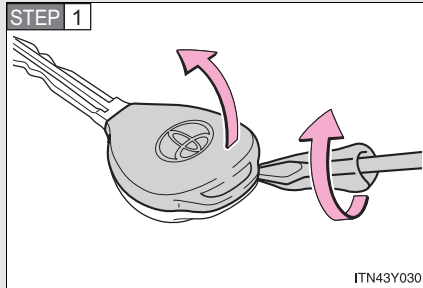

Remove the cover.

To prevent damage to the key, cover the tip of the screwdriver with a rag.

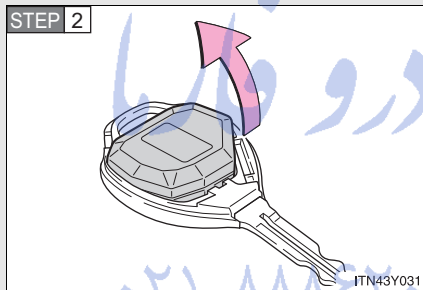

Remove the module.

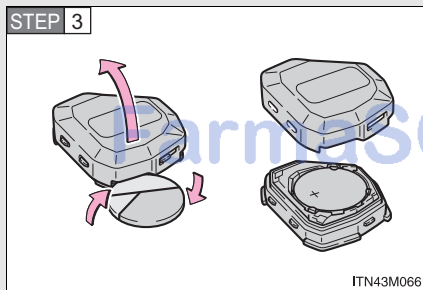

Open the case cover using a coin protected with tape etc. and remove the depleted battery.

Insert a new battery with the "+" terminal facing up.

■ Vehicles with a smart entry & start system

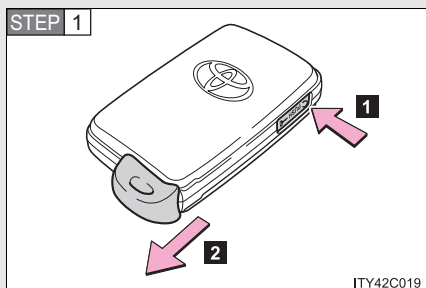

Take out the mechanical key.

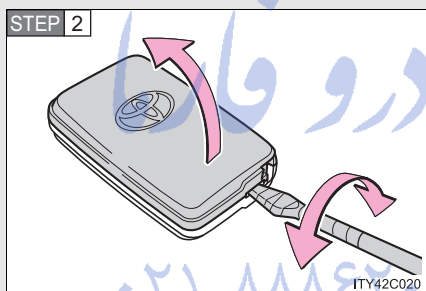

Remove the cover.

To prevent damage to the key, cover the tip of the screwdriver with a rag.

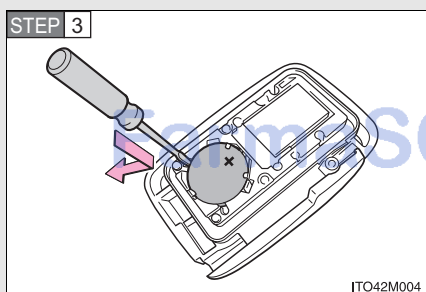

Remove the depleted battery.

Insert a new battery with the "+" terminal facing up.

■ **Use the following types of lithium battery**

Vehicles without a smart entry & start system (type A): CR2032

Vehicles without a smart entry & start system (type B): CR2016

Vehicles with a smart entry & start system: CR1632

- Batteries can be purchased at any authorized Toyota dealer or repairer, or another duly qualified and equipped professional, local electrical appliance shops or camera stores.
- Replace only with the same or equivalent type recommended by the manufacturer.
- Dispose of used batteries according to the local laws.

■ **If the electronic key battery is discharged**

The following symptoms may occur:

- The smart entry & start system (if equipped) and wireless remote control will not function properly.
- The operational range will be reduced.

تلفن شبانه روزی: ۰۲۱-۸۸۶۲۰۸۵

FarmaSOS.com

 CAUTION

■ **Removed battery and other parts**

These parts are small and if swallowed by a child, they can cause choking. Keep away from children. Failure to do so could result in death or serious injury.

■ **Certification for the key battery**

RISK OF EXPLOSION IF BATTERY IS REPLACED BY AN INCORRECT TYPE. DISPOSE OF USED BATTERIES ACCORDING TO THE INSTRUCTIONS.

 NOTICE

■ **For normal operation after replacing the battery**

Observe the following precautions to prevent accidents:

- Always work with dry hands.
Moisture may cause the battery to rust.
- Do not touch or move any other components inside the remote control.
- Do not bend the battery terminals.

FarmaSOS.com

4-3. Do-it-yourself maintenance

Checking and replacing fuses

If any of the electrical components do not operate, a fuse may have blown. If this happens, check and replace the fuses as necessary.

STEP 1 Vehicles without a smart entry & start system

Turn the engine switch off.

Vehicles with a smart entry & start system

Turn the "ENGINE START STOP" switch off.

STEP 2 Open the fuse box cover.

Engine compartment

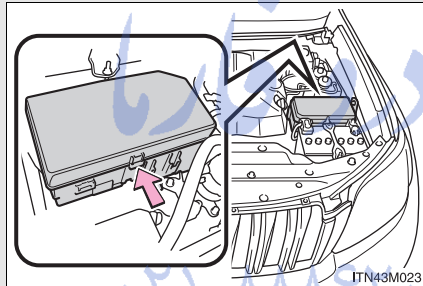

Push the tab in and lift the lid off.

4

Maintenance and care

FarmaSOS.com

Driver's side instrument panel

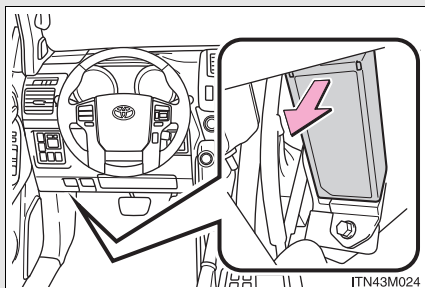

Remove the lid.

STEP 3 After a system failure, see "Fuse layout and amperage ratings" (→P. 665) for details about which fuse to check.

STEP 4 Remove the fuse with the pull-out tool.

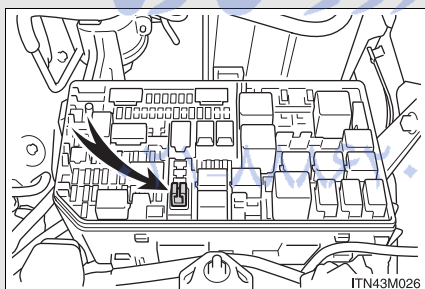

Only type A fuse can be removed using the pullout tool.

تلفن شبانه روزی: ۸۵

FarmaSOS.com

STEP 5 Check if the fuse is blown.

Type A

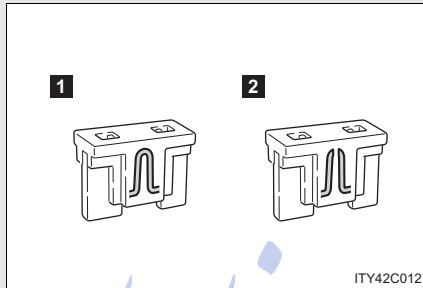

1 Normal fuse

2 Blown fuse

Replace the blown fuse with a new fuse of an appropriate amperage rating. The amperage rating can be found on the fuse box lid.

Type B

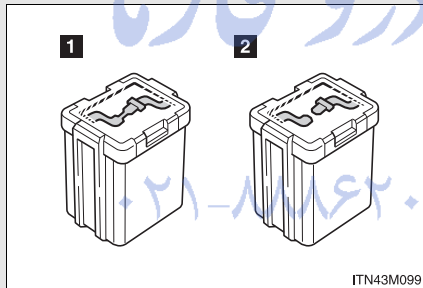

1 Normal fuse

2 Blown fuse

Contact any authorized Toyota dealer or repairer, or another duly qualified and equipped professional.

Type C

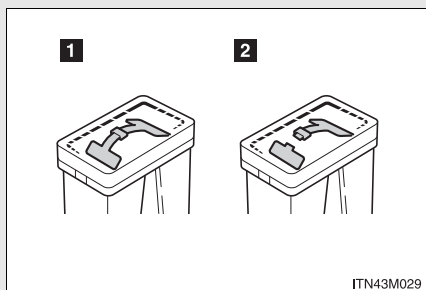

- 1 Normal fuse
- 2 Blown fuse

Contact any authorized Toyota dealer or repairer, or another duly qualified and equipped professional.

Type D

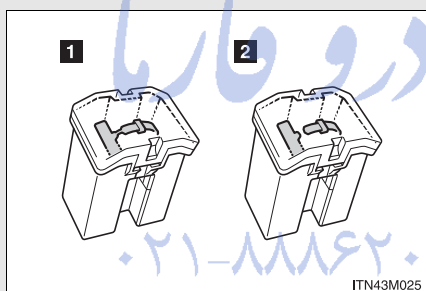

- 1 Normal fuse
- 2 Blown fuse

Contact any authorized Toyota dealer or repairer, or another duly qualified and equipped professional.

Type E

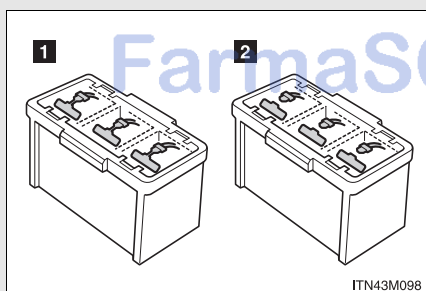

- 1 Normal fuse
- 2 Blown fuse

Contact any authorized Toyota dealer or repairer, or another duly qualified and equipped professional.

Fuse layout and amperage ratings

Engine compartment

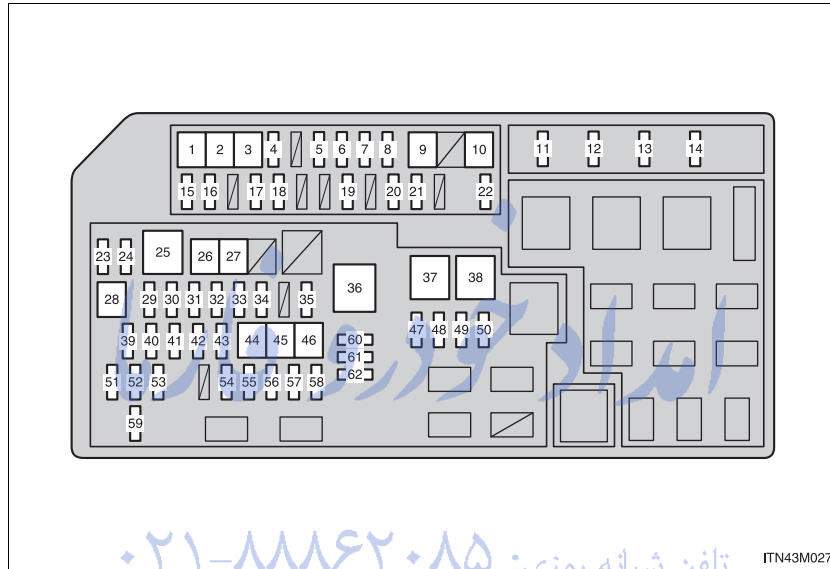

Fuse	Ampere	Circuit
1	40 A	Rear air conditioning system
2	30 A	PTC heater
3	50 A	Air suspension system, AIR SUS NO.2
4	15 A	Inverter
5	30 A	Rear window defogger
6	7.5 A	Rear fog lights
7	20 A	Windshield wiper deicer

4-3. Do-it-yourself maintenance

	Fuse	Ampere	Circuit
8	FUEL HTR* ¹	25 A	Fuel heater
	AIR PMP HTR* ²	10 A	Air pump heater
9	PTC HTR NO.2	30 A	PTC heater
10	PTC HTR NO.1	50 A	PTC heater
11	IG2	20 A	Injector, ignition, meter
12	HORN	10 A	Horn
13	EFI	25 A	EFI ECU, EDU, ECT ECU, fuel pump, A/F heater relay, FPC, EFI NO.2
14	A/F* ³	20 A	A/F SSR
	EFI MAIN* ⁹	20 A	A/F SSR, EFI No.2
15	MIR HTR	15 A	Mirror heater
16	VISCUS* ¹	10 A	VISC heater
17	FOLD SEAT LH	30 A	Folding seat (left)
18	FOLD SEAT RH	30 A	Folding seat (right)
19	A/C COMP	10 A	Air conditioning system
20	CDS FAN	20 A	Condenser fan
21	STOP	10 A	Emergency stop light relay, stop lights, high mount stop light, stop light switch, VSC/ABS ECU, towing, smart entry & start system, ECT ECU
22	AIR SUS NO.2	7.5 A	AIR SUS ECU
23	H-LP RH-HI	15 A	Headlight high beam (right)
24	H-LP LH-HI	15 A	Headlight high beam (left)
25	HTR	50 A	Air conditioning system
26	WIP WSH RR	30 A	Rear window wipers and washer

	Fuse	Ampere	Circuit
27	H-LP CLN	30 A	Headlight cleaner
28	ST	30 A ^{*3} 40 A ^{*4}	STARTER MTR
29	H-LP HI	25 A	DIM relay, headlights
30	ALT-S	7.5 A	ALT
31	TURN & HAZ	15 A	Front turn signal light, rear turn signal light, side turn signal light, meter turn signal light, trailer light
32	D/L NO.1	25 A	Door lock motor, glass hatch opener
33	ETCS ^{*3}	10 A	EFI ECU
	EDU ^{*9}	20 A	Multiport fuel injection system/ sequential multiport fuel injection system
34	FUEL PMP ^{*5}	15 A	Fuel pump
35	TOWING	30 A	Towing: تلفن شبانه روزی: ۸۷۴۲۰۸۱
36	ALT	140 A ^{*6} 120 A ^{*3,7}	Air conditioning system, AIR SUS, headlight cleaner, PTC heater, towing, folding seat, STOP, rear window defogger, MIR HTR, CDS FAN, RR FOG, DEICER, MG-CLT, J/B, INV, RR WIP, RR WSH
37	P/I-B	80 A	Injector, ignition, meter, EFI, A/F heater, horn
38	GLOW ^{*4}	80 A	Glow plug
39	RAD NO.1	15 A	Audio system, navigation system, rear seat entertainment system
40	AM2	7.5 A	Starter system

4-3. Do-it-yourself maintenance

Fuse		Ampere	Circuit
41	RAD NO.2	10 A	Navigation system
42	MAYDAY*8	7.5 A	Multiport fuel injection system/ sequential multiport fuel injection system
43	AMP	30 A	Audio system
44	ABS NO.1	50 A	ABS, VSC
45	ABS NO.2	30 A	ABS, VSC
46	AIR PMP*3	50 A	Air pump
47	SECURITY	10 A	Multiport fuel injection system/ sequential multiport fuel injection system
48	SMART	7.5 A	Smart entry & start system
49	STRG LOCK	20 A	Steering lock system
50	TOWING BRK	30 A	Towing
51	WIP RR	15 A	Rear window wiper
52	DOME	10 A	Interior lights, personal lights, van- ity lights, door courtesy lights, foot- well lights, outer foot lights, overhead module
53	ECU-B	10 A	BODY ECU, meter, heater, steering sensor, wireless remote control, seat position memory, tilt and tele- scopic steering, multi display, smart entry & start system, folding seat, cool box, DSS#2 ECU, steering switch, D-module switch, overhead module

	Fuse	Ampere	Circuit
54	H-LP RH-LO	15 A	Headlight low beam (right), headlight leveling system
55	H-LP LH-LO	15 A	Headlight low beam (left)
56	INJ	10 A	Coil, injector, ignition, ECT ECU, noise filter
57	EFI NO.2	10 A	O2 SSR, AFM, ACIS VSV, AI COMB, EYP VSV, AI DRIVER, EGR VSV, SWIRL VSV, SWIRL VSV 2, E/G CUT VSV, EGR COOL BYPASS VSV, D-SLOT ROTARY SOL, AI VSV RLY
58	WIP FR NO.2	7.5 A	DSS#1 ECU
59	WSH RR	15 A	Rear window washer
60	SPARE	—	Spare fuse
61	SPARE	—	Spare fuse
62	SPARE	—	Spare fuse

- *1: 1KD -FTV models only
 *2: 1GR-FE models only
 *3: Vehicles with gasoline engine
 *4: Vehicles with diesel engine
 *5: 1KD-FTV models with sub fuel tank only
 *6: 1KD-FTV models with left hand drive vehicle
 *7: 1KD-FTV models with right hand drive vehicle
 *8: 1GR-FE models with right hand drive vehicle
 *9: 1KD-FTV models (KDJ150R-GKFEYW, KDJ150R-GKAEYW, KDJ150L-GKFEYW, KDJ150L-GKAEYW, KDJ155R-GJFEYW, KDJ155R-GJAEYW, KDJ155L-GJFEYW and KDJ155L-GJAEYW models^{*10} except for Russia, Ukraine, Serbia, Montenegro, Macedonia and Croatia)
 *10: The model code is indicated on the manufacturer's label. (→P. 815)

Under the instrument panel

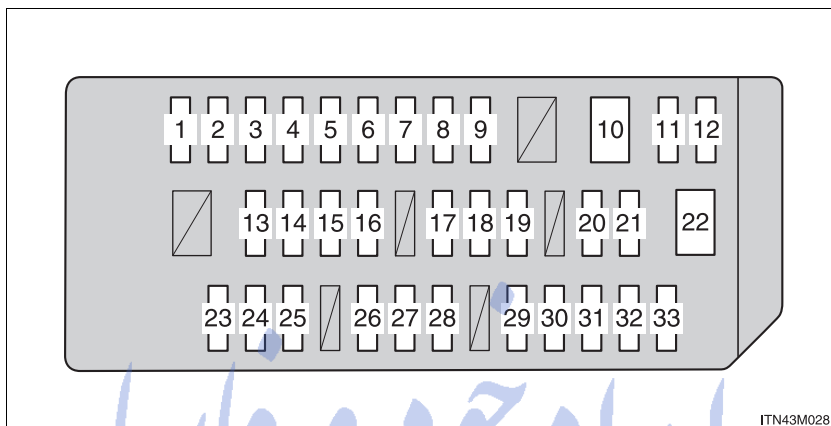

ITN43M028

	Fuse	Ampere	Circuit
1	P/OUTLET	15 A	Power outlet
2	ACC	7.5 A	Outside rear view mirror motor, BODY ECU, air conditioning system, audio system, navigation system, parking assist system, sequential switch, back up relay, DSS#2 ECU, AT indicator, EFI ECU, shift lock ECU
3	BKUP LP	10 A	Back-up lights, audio system, multi information display, DSS#2 ECU, parking assist sensor

Fuse		Ampere	Circuit
4	TOWING BKUP	10 A	Towing
5	AVS	20 A	Air suspension system
6	KDSS	10 A	KDSS ECU
7	4WD	20 A	4WD system, rear differential lock
8	P/SEAT FL	30 A	Front power seat (left)
9	D/L NO.2	25 A	Door lock motor, glass hatch opener, BODY ECU
10	PSB	30 A	PSB ECU
11	TI & TE	15 A	Tilt and telescopic steering
12	FOG FR	15 A	Front fog lights
13	OBD	7.5 A	DLC 3
14	A/C	7.5 A	Air conditioning system
15	AM1	7.5 A	Starting system
16	DOOR RL	25 A	Rear power window (left)
17	ECU-IG NO.1	10 A	Shift lock ECU, VSC ECU, steering sensor, yaw rate sensor, sequential switch, auto wiper ECU, back up relay, outside rear view mirror heater, tilt & telescopic steering, PSB ECU, DSS#1 ECU, front radar sensor, power steering ECU, AFS ECU

4-3. Do-it-yourself maintenance

Fuse		Ampere	Circuit
18	IG1	7.5 A	Front turn signal light, rear turn signal light, side turn signal light, meter turn signal light, trailer light, ALT, VSC, C/C switch
19	ECU-IG NO.2	10 A	Rear window defogger, seat heater switch, inverter relay, air conditioning system, EC mirror, BODY ECU, power heater switch, navigation system, DSS#2 ECU, moon roof ECU, meter switch, parking assist sensor, accessory meter, folding seat ECU, O/H IG, deicer, AFS ECU, D-module, rain sensor, air suspension, P/SEAT IND
20	S/HTR FR	20 A	Seat heater
21	P/SEAT FR	30 A	Front power seat (right)
22	DOOR P	30 A	Front power window (passenger's side)
23	DOOR	10 A	Power window
24	DOOR D	25 A	Front power window (driver's side)
25	DOOR RR	25 A	Rear power window (right)
26	S/ROOF	25 A	Moon roof
27	WIP	30 A	Windshield wipers and washer
28	WASHER	20 A	Windshield wipers and washer, rear window wipers and washer

	Fuse	Ampere	Circuit
29	COOLING	10 A	Cool box
30	IGN	10 A	EFI ECU, C/OPN RLY, VSC ECU, air bag ECU, smart entry & start system, steering lock ECU, CAN gateway ECU
31	GAUGE	7.5 A	Meter
32	PANEL	7.5 A	Switch illumination, glove box light, navigation system, audio system, air conditioning system, outside rear view mirror switch, folding seat switch, multi-information display, P/SEAT IND, SHIFT, COOL BOX
33	TAIL	10 A	Front position lights, tail lights, license plate lights, EFI ECU, rear fog lights, towing, front fog lights

تلفن شبانه روزی: ۰۲۱-۸۸۶۲۰۸۵

FarmaSOS.com

■ **After a fuse is replaced**

- If the lights do not turn on even after the fuse has been replaced, a bulb may need replacement. (→P. 675)
- If the replaced fuse blows again, have the vehicle inspected by any authorized Toyota dealer or repairer, or another duly qualified and equipped professional.

■ **If there is an overload in a circuit**

The fuses are designed to blow, protecting the wiring harness from damage.

 **CAUTION**

■ **To prevent system breakdowns and vehicle fire**

Observe the following precautions.

Failure to do so may cause damage to the vehicle, and possibly a fire or injury.

- Never use a fuse of a higher amperage rating than indicated, or use any other object in place of a fuse.
- Always use a genuine Toyota fuse or equivalent. تلفن شبانه ۰۸۵۲-۸۸۶۲-۰۲۰
Never replace a fuse with a wire, even as a temporary fix.
- Do not modify the fuses or the fuse boxes.

 **NOTICE**

■ **Before replacing fuses**

Have the cause of electrical overload determined and repaired by any authorized Toyota dealer or repairer, or another duly qualified and equipped professional, as soon as possible.

4-3. Do-it-yourself maintenance

Light bulbs

You may replace the following bulbs yourself. The difficulty level of replacement varies depending on the bulb. If necessary bulb replacement seems difficult to perform, contact any authorized Toyota dealer or repairer, or another duly qualified and equipped professional.

For more information about replacing other light bulbs, contact any authorized Toyota dealer or repairer, or another duly qualified and equipped professional.

■ Preparing for light bulb replacement

Check the wattage of the light bulb being replaced. (→P. 843)

■ Removing the engine compartment covers

→P. 626

■ Front bulb locations

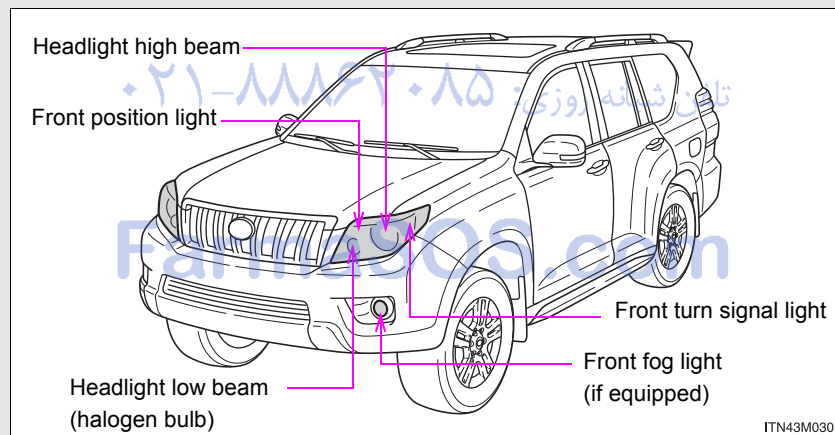

■ **Rear bulb locations**

Vehicles with under floor mounted spare tire and without spare tire

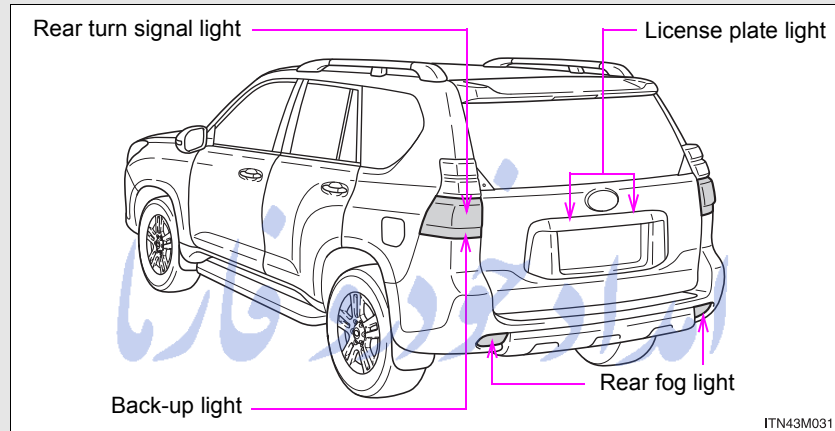

Vehicles with back door mounted spare tire

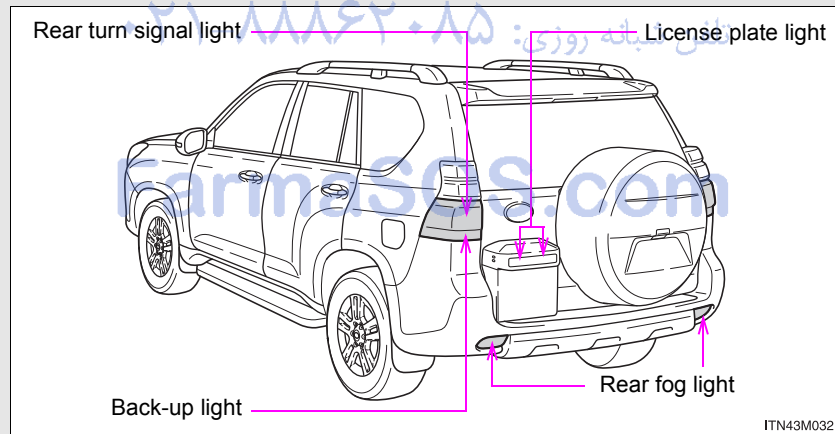

Replacing light bulbs

■ Headlight low beams (vehicles with halogen bulbs)

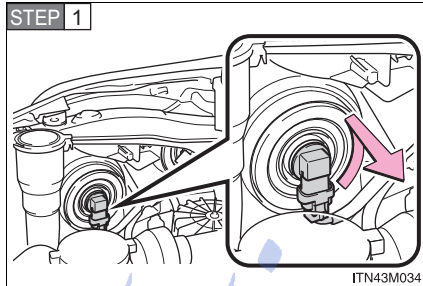

Turn the bulb base counterclockwise.

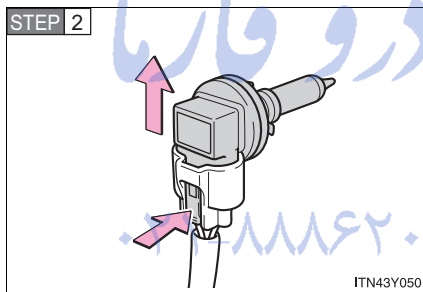

Unplug the connector while pushing the lock release.

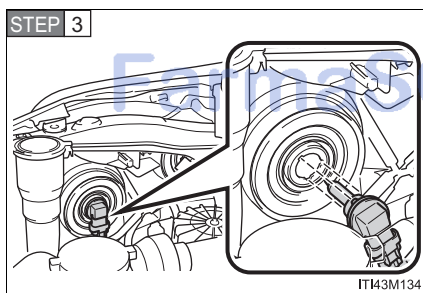

Replace the light bulb, and install the bulb base.

Align the 3 tabs on the light bulb with the mounting, and insert.

4-3. Do-it-yourself maintenance

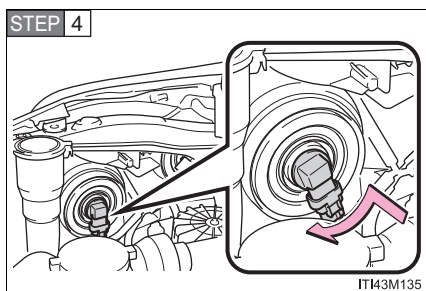

Turn and secure the bulb base.

Shake the bulb base gently to check that it is not loose, turn the headlights on once and visually confirm that no light is leaking through the mounting.

■ Headlight high beams

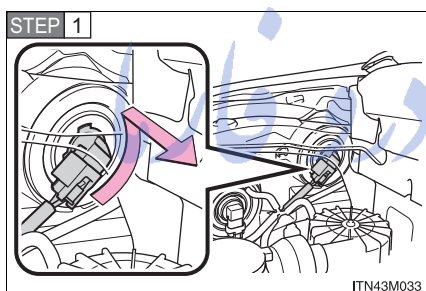

Turn the bulb base counterclockwise.

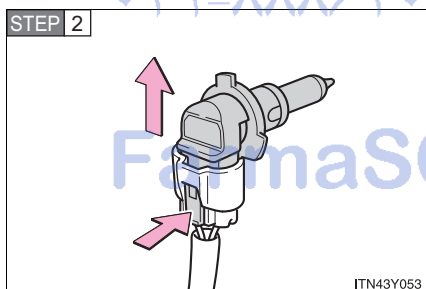

Unplug the connector while pushing the lock release.

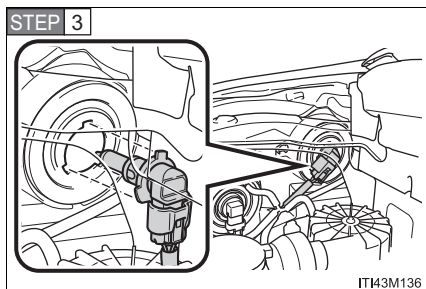

Replace the light bulb, and install the bulb base.

Align the 3 tabs on the light bulb with the mounting, and insert.

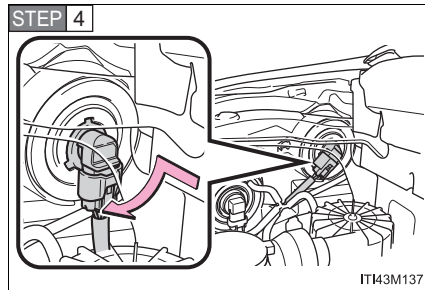

Turn and secure the bulb base.

Shake the bulb base gently to check that it is not loose, turn the headlights on once and visually confirm that no light is leaking through the mounting.

■ Front fog lights (if equipped)

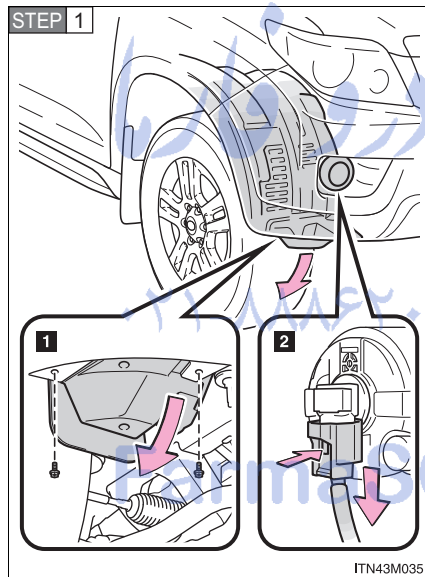

1 Remove the fender liner bolt and partly remove the fender liner.

2 Unplug the connector while pushing the lock release.

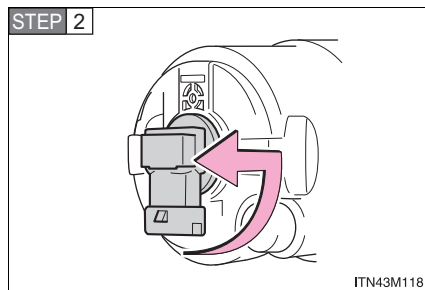

Turn the light bulb counterclockwise.

4-3. Do-it-yourself maintenance

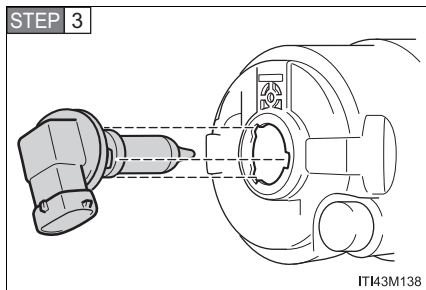

Replace the light bulb.

Align the 3 tabs on the light bulb with the mounting, and insert.

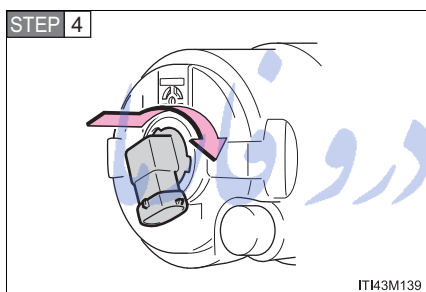

Turn and secure the bulb base.

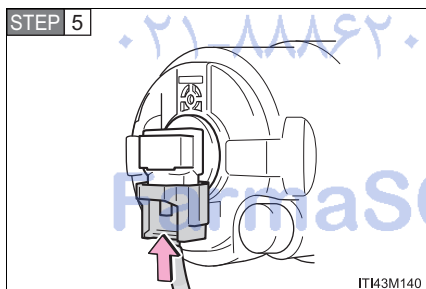

Install the bulb base.

Shake the bulb base gently to check that it is not loose, turn the fog lights on once and visually confirm that no light is leaking through the mounting.

STEP 6 When installing the cover, conduct **STEP 1** in reverse.

■ Front position lights

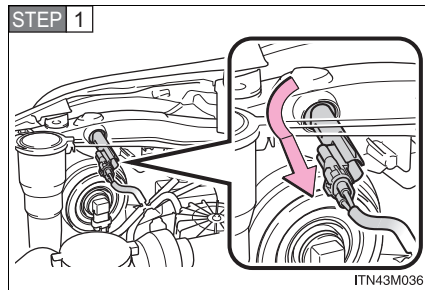

Turn the bulb base counterclockwise.

The shape of the bulb base differs slightly on the left and right sides.

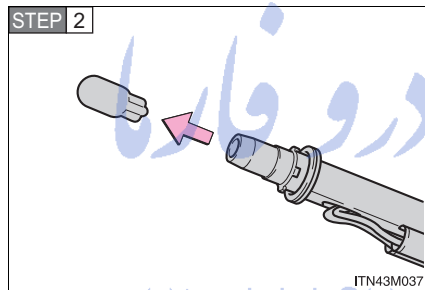

Remove the light bulb.

تلفن شبانه روزی: ۰۲۱-۸۸۶۲۰۸۵

FarmaSOS.com

■ Front turn signal lights

STEP 1 Remove the fender liner bolts.

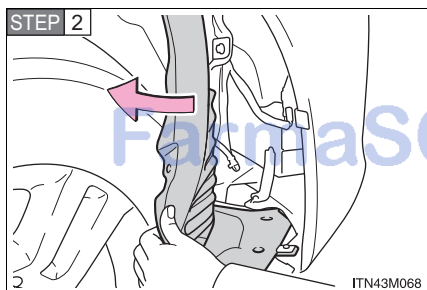
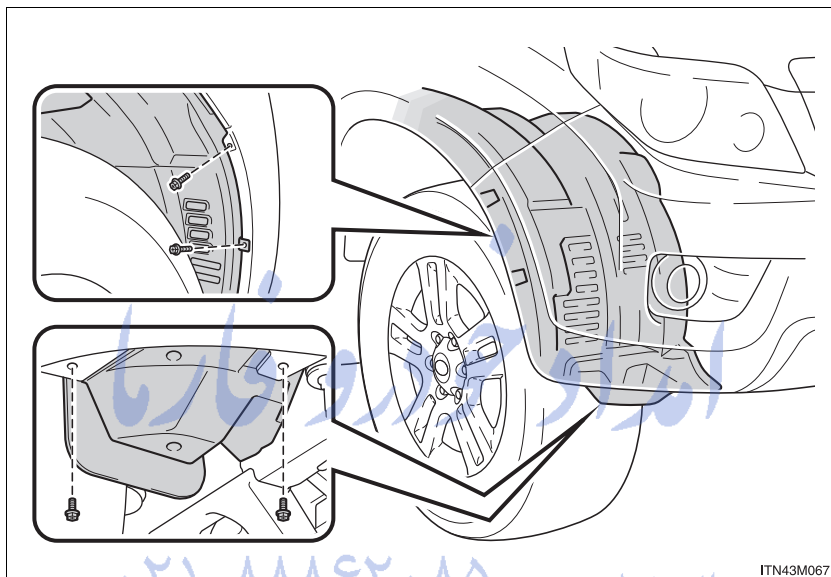

Remove the fender liner.

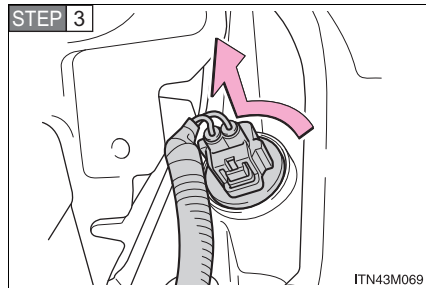

Turn the bulb base counterclockwise.

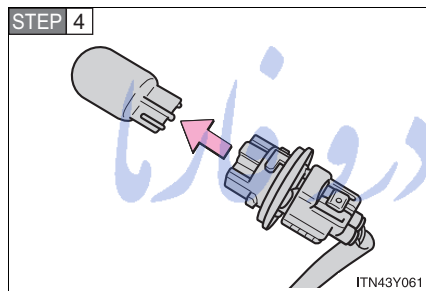

Remove the light bulb.

تلفن شبانه روزی: ۰۲۱-۸۸۶۲۰۸۵

FarmaSOS.com

■ Rear turn signal lights and back-up lights

STEP 1 Open the back door.

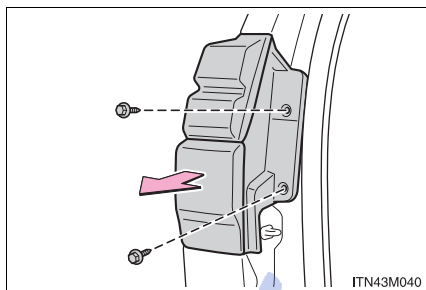

Left-hand side:

Remove the bolts and lamp assembly.

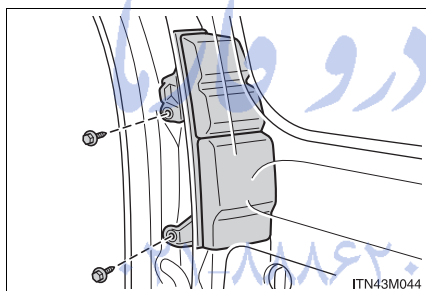

Right-hand side:

Remove the bolts.

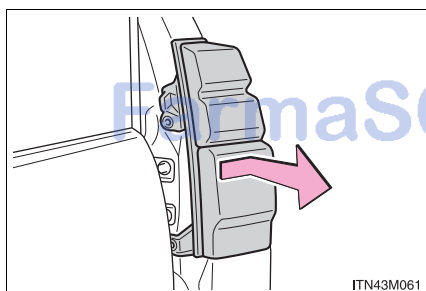

Close the back door half way and remove the lamp assembly.

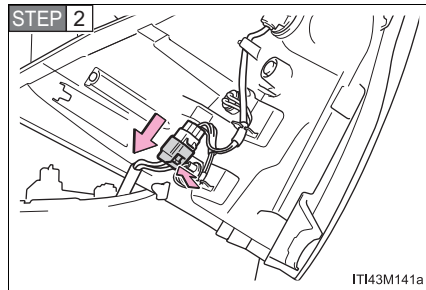

Unplug the connector while pushing the lock release.

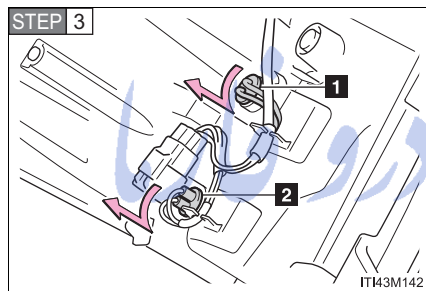

Turn the bulb bases counter-clockwise.

- 1 Rear turn signal light
- 2 Back-up light

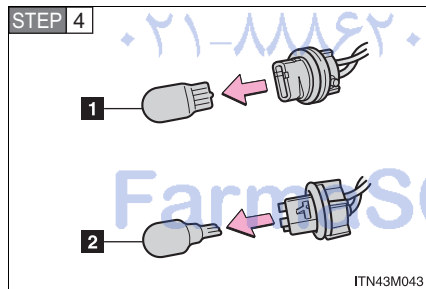

Remove the light bulb.

- 1 Rear turn signal light
- 2 Back-up light

■ Rear fog lights (if equipped)

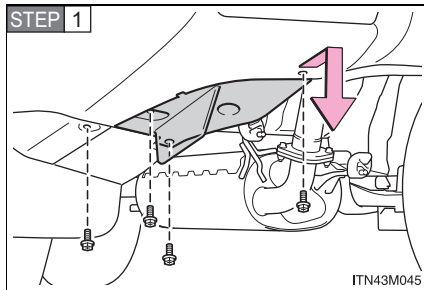

Remove the under cover bolts and pull down the under cover.

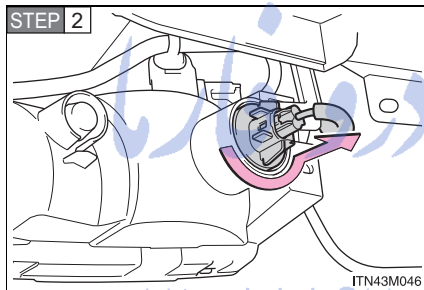

Turn the bulb base counterclockwise.

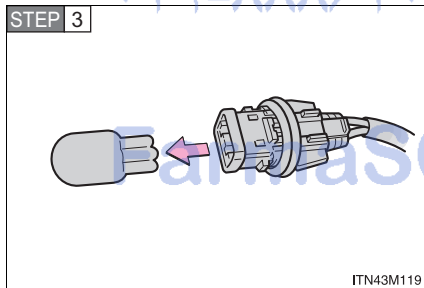

Remove the light bulb.

■ License plate lights

Vehicles with under floor mounted spare tire and without spare tire

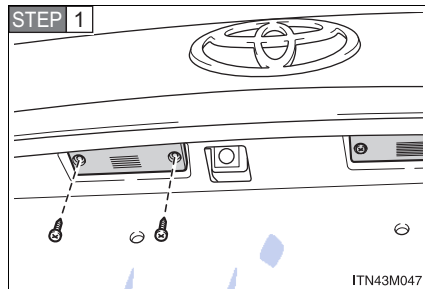

Remove the screws.

Remove the lens and the license plate light unit.

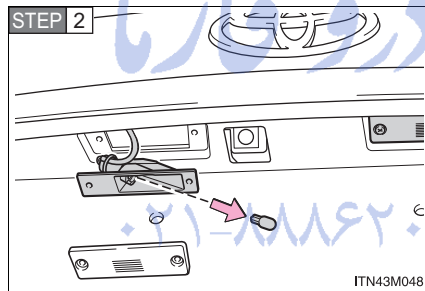

Remove the light bulb.

FarmaSOS.com

Vehicles with back door mounted spare tire

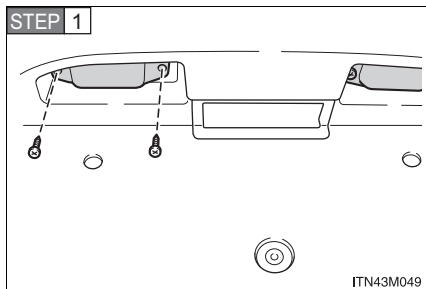

Remove the screws.

Remove the lens and the licence plate light unit.

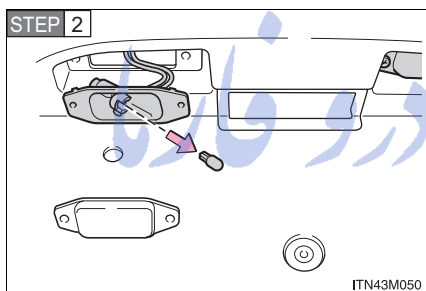

Remove the light bulb.

■ Lights other than the above

If any of the lights listed below has burnt out, have it replaced by any authorized Toyota dealer or repairer, or another duly qualified and equipped professional.

- Headlight low beams (high-intensity discharge bulbs)
- Side turn signal lights
- High mounted stoplight
- Stop/tail lights

■ **High-intensity discharge (HID) headlights**

If voltage to the high-intensity discharge bulbs is insufficient, the light may not come on, or may go out temporarily. The high-intensity discharge bulbs will come on when normal power is restored.

■ **LED light bulbs**

The side turn signal lights, tail/stop lights and high mounted stoplight consists of a number of LEDs. If any of the LEDs burn out, take your vehicle to any authorized Toyota dealer or repairer, or another duly qualified and equipped professional to have the light replaced.

■ **Condensation build-up on the inside of the lens**

Contact any authorized Toyota dealer or repairer, or another duly qualified and equipped professional, for more information in the following situations. Temporary condensation build-up on the inside of the headlight lens does not indicate a malfunction.

- Large drops of water are built up on the inside of the lens.
- Water has built up inside the headlight.

تلفن شبانه روزی: ۰۲۱-۸۸۶۲۰۸۵

FarmaSOS.com

 CAUTION

■ **Replacing light bulbs**

- Turn off the headlights. Do not attempt to replace the bulb immediately after turning off the headlights.
The bulbs become very hot and may cause burns.
- Do not touch the glass portion of the light bulb with bare hands. Hold the bulb by the plastic or metal portion.
If the bulb is scratched or dropped it may blow out or crack.
- Fully install light bulbs and any parts used to secure them. Failure to do so may result in heat damage, fire, or water entering the headlight unit. This may damage the headlights or cause condensation to build up on the lens.

■ **High-intensity discharge (HID) headlights**

- Contact any authorized Toyota dealer or repairer, or another duly qualified and equipped professional before replacing high-intensity discharge headlights (including light bulbs).
- Do not touch the high-intensity discharge headlight's high voltage socket when the headlights are turned on.
An extremely high voltage of 20000 V will be discharged and could result in death or serious injury by electric shock.
- Do not attempt to repair or disassemble light bulbs, connectors, electric circuits or component parts.
Doing so may result in death or serious injury due to electric shock.

■ **To prevent damage or fire**

- Make sure bulbs are fully seated and locked.
- Check the wattage of the bulb before installing to prevent heat damage.

When trouble arises

5

5-1. Essential information

Emergency flashers	692
If your vehicle needs to be towed	694
If you think something is wrong	701
Fuel pump shut off system (gasoline engine only)	702

5-2. Steps to take in an emergency

If a warning light turns on or a warning buzzer sounds	703
If a warning message is displayed	718

If you have a flat tire (vehicles with a standard spare tire)	743
If you have a flat tire (vehicles with an emergency tire puncture repair kit)	765
If the engine will not start	786
If the shift lever cannot be shifted from P	789
If you lose your keys/wireless remote control transmitter	790
If the electronic key does not operate properly	791
If the vehicle battery is discharged	795
If your vehicle overheats	803
If you run out of fuel and the engine stalls (diesel engine only)	806
If the vehicle becomes stuck	807
If your vehicle has to be stopped in an emergency	809

5-1. Essential information

Emergency flashers

Use the emergency flashers if the vehicle malfunctions or is involved in an accident.

Type A

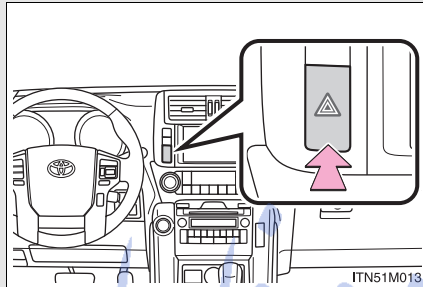

Press the switch to flash all the turn signal lights. To turn them off, push the switch once again.

Type B

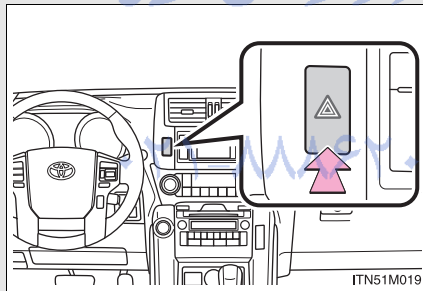

Press the switch to flash all the turn signal lights. To turn them off, push the switch once again.

Type C

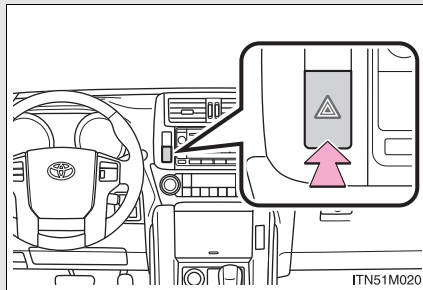

Press the switch to flash all the turn signal lights. To turn them off, push the switch once again.

NOTICE

■ To prevent battery discharge

Do not leave the emergency flashers on longer than necessary when the engine is not running.

تلفن شبانه روزی: ۰۲۱-۸۸۶۲۰۸۵

FarmaSOS.com

5-1. Essential information

If your vehicle needs to be towed

If towing is necessary, we recommend having your vehicle towed by any authorized Toyota dealer or repairer, or another duly qualified and equipped professional, such as a commercial towing service, using a lift-type truck or a flat bed truck.

Use a safety chain system for all towing, and abide by all state/provincial and local laws.

Before towing

The following may indicate a problem with your transmission. Contact any authorized Toyota dealer or repairer, or another duly qualified and equipped professional, before towing.

- The engine is running but the vehicle will not move.
- The vehicle makes an abnormal sound.

تلفن شبانه روزی: ۰۲۱-۸۸۸۶۲۰۸۵

FarmaSOS.com

Emergency towing

If a tow truck is not available in an emergency, your vehicle may be temporarily towed using a cable or chain secured to the emergency towing hooks. This should only be attempted on hard surfaced roads for short distances at low speeds.

A driver must be in the vehicle to steer and operate the brakes. The vehicle's wheels, drive train, axles, steering and brakes must be in good condition.

For vehicles with an automatic transmission, only the front towing hooks may be used.

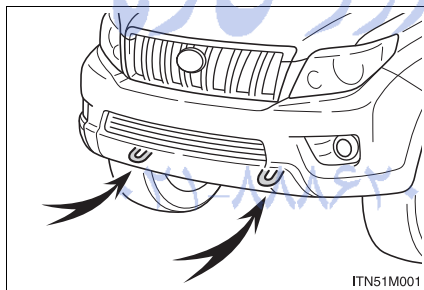
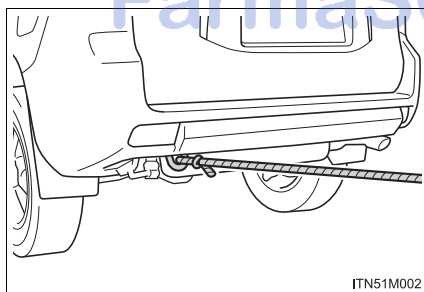
Towing hook (front)**Towing hook (rear)**

Towing with a sling-type truck



Do not tow with a sling type truck to prevent body damage.

Towing with a wheel lift-type truck

From the front

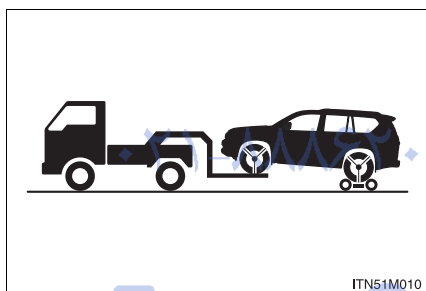

Use a towing dolly under the rear wheels.

From the rear

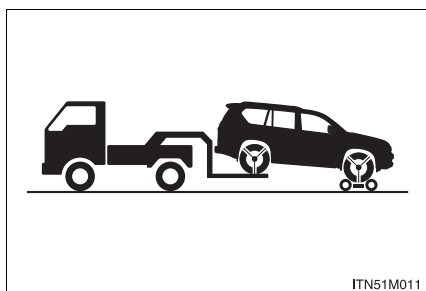

Use a towing dolly under the front wheels.

Using a flat bed truck

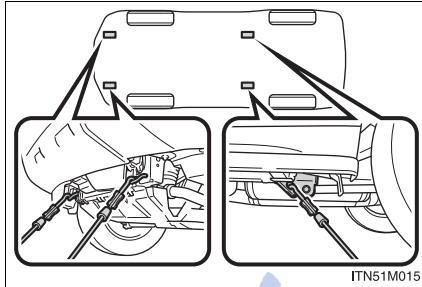

If your Toyota is transported by a flat bed truck, it should be tied down at the locations shown in the illustration.

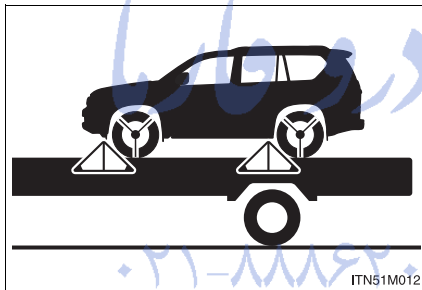

If you use chains or cables to tie down your vehicle, the angles shaded in black must be 45°.

Do not overly tighten the tie downs or the vehicle may be damaged.

FarmaSOS.com

■ **Before emergency towing**

Vehicles without a smart entry & start system

- STEP 1** Release the parking brake.
- STEP 2** Put the four-wheel drive control switch in H4F. (The center differential is unlocked.)
- STEP 3** Shift the shift lever in N (automatic transmission) or neutral (manual transmission).
- STEP 4** Put the engine switch in the “ACC” (engine off) or “ON” position (engine running).

Vehicles with a smart entry & start system

- STEP 1** The “ENGINE START STOP” switch must be in the ACCESSORY mode (engine off) or IGNITION ON mode (engine running).
- STEP 2** Put the four-wheel drive control switch in H4. (The center differential is unlocked.)
- STEP 3** Put the vehicle height in the N mode and press height control switch to turn off the rear height control air suspension. (if equipped)
- STEP 4** Shift the shift lever in N (automatic transmission) or neutral (manual transmission).
- STEP 5** Release the parking brake.

FarmaSOS.com

⚠ CAUTION**■ Caution while towing**

- Use extreme caution when towing the vehicle.
Avoid sudden starts or erratic driving maneuvers which place excessive stress on the emergency towing hook and the cables or chains. Always be cautious of the surroundings and other vehicles while towing.
- Vehicles with a smart entry & start system:
Do not turn the “ENGINE START STOP” switch off.
Doing so will lock the steering wheel and prevent operation, possibly causing an accident and resulting in death or serious injury.
- If the engine is not running, the power assist for the brakes and steering will not function, making steering and braking more difficult.

■ Before emergency towing (vehicles with rear height control air suspension)

When your vehicle is towed, put the vehicle height in the “N” mode and push the height control off button to turn off the rear height control suspension system.

Otherwise, the vehicle height may be changed in the automatic leveling function, resulting in an unexpected accident. For details, refer to the “Off-road driving Owner’s manual”.

FarmaSOS.com

 NOTICE

■ **To prevent causing serious damage to the transmission and transfer when towing using a wheel-lift type truck**

Never tow this vehicle with any of the wheels in contact with the ground.

■ **To avoid serious damage to your vehicle (vehicles with an automatic transmission)**

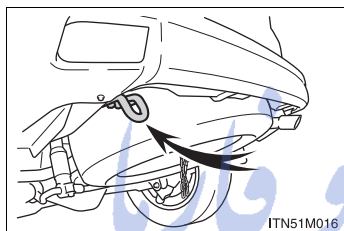

Do not use the rear emergency towing hook.

■ **To prevent damage to the vehicle when towing using a wheel-lift type truck**

When raising the vehicle, ensure adequate ground clearance for towing at the opposite end of the raised vehicle. Without adequate clearance, the vehicle could be damaged while being towed. تلفن شبانه روزی

■ **To prevent body damage when towing with a sling-type truck**

Do not tow with a sling-type truck, either from the front or rear.

■ **To prevent causing serious damage to the transmission and transfer in emergency towing (vehicles with an automatic transmission)**

Never tow a vehicle from the rear with four wheels on the ground. This may cause serious damage to the transmission.

5-1. Essential information

If you think something is wrong

If you notice any of the following symptoms, your vehicle probably needs adjustment or repair. Contact any authorized Toyota dealer or repairer, or another duly qualified and equipped professional, as soon as possible.

■ Visible symptoms

- Fluid leaks under the vehicle
(Water dripping from the air conditioning after use is normal.)
- Flat-looking tires or uneven tire wear
- Engine coolant temperature gauge needle continually points higher than normal

■ Audible symptoms

- Changes in exhaust sound
- Excessive tire squeal when cornering
- Strange noises related to the suspension system
- Pinging or other noises related to the engine

■ Operational symptoms

- Engine missing, stumbling or running roughly
- Appreciable loss of power
- Vehicle pulls heavily to one side when braking
- Vehicle pulls heavily to one side when driving on a level road
- Loss of brake effectiveness, spongy feeling, pedal almost touches the floor

5

When trouble arises

5-1. Essential information

Fuel pump shut off system (gasoline engine only)

To minimize the risk of fuel leakage when the engine stalls or when an airbag inflates upon collision, the fuel pump shut off system stops the supply fuel to the engine.

Follow the procedure below to restart the engine after the system is activated.

Vehicles without a smart entry & start system

STEP 1 Turn the engine switch to the “ACC” or “LOCK” position.

STEP 2 Restart the engine.

Vehicles with a smart entry & start system

STEP 1 Turn the “ENGINE START STOP” switch to ACCESSORY mode or turn it off.

STEP 2 Restart the engine.

NOTICE

■ Before starting the engine

Inspect the ground under the vehicle.

If you find that fuel has leaked onto the ground, the fuel system has been damaged and is in need of repair. Do not restart the engine.

5-2. Steps to take in an emergency

If a warning light turns on or a warning buzzer sounds...

Calmly perform the following actions if any of the warning lights comes on or flashes. If a light comes on or flashes, but then goes off, this does not necessarily indicate a malfunction in the system. However, if this continues to occur, have the vehicle inspected by any authorized Toyota dealer or repairer, or another duly qualified and equipped professional.

Stop the vehicle immediately. Continuing to drive the vehicle may be dangerous.

The following warning indicates a possible problem in the brake system. Immediately stop the vehicle in a safe place and contact any authorized Toyota dealer or repairer, or another duly qualified and equipped professional.



Warning light	Warning light/Details
	Brake system warning light (warning buzzer)* <ul style="list-style-type: none">• Low brake fluid• Malfunction in the brake system This light also comes on when the parking brake is not released. If the light turns off after the parking brake is fully released the system is operating normally.

*: Parking brake engaged warning buzzer:

A buzzer will sound if the vehicle is driven at a speed of approximately 5 km/h (3 mph) or more.

Stop the vehicle immediately.





The following warnings indicate the possibility of damage to the vehicle that may lead to an accident. Immediately stop the vehicle in a safe place and contact any authorized Toyota dealer or repairer, or another duly qualified and equipped professional.

Warning light	Warning light/Details
	Charging system warning light Indicates a malfunction in the vehicle's charging system.
	Low engine oil pressure warning light (vehicles with non-optitron type meters) Indicates that the engine oil pressure is too low





Have the vehicle inspected immediately.



Failing to investigate the cause of the following warnings may lead to the system operating abnormally and possibly cause an accident. Have the vehicle inspected by any authorized Toyota dealer or repairer, or another duly qualified and equipped professional, immediately.

FarmaSOS.com

Warning light	Warning light/Details
	<p>Malfunction indicator lamp Indicates a malfunction in:</p> <ul style="list-style-type: none"> • The emission control system; • The electronic engine control system; • The electronic throttle control system; or • The electronic automatic transmission control system.
	<p>SRS warning light Indicates a malfunction in:</p> <ul style="list-style-type: none"> • The SRS airbag system; or • The seat belt pretensioner system.
	<p>ABS warning light Indicates a malfunction in:</p> <ul style="list-style-type: none"> • The ABS; or • The brake assist system
	<p>Power steering system warning light Indicates a malfunction in the power steering system</p>
 (Flashes)	<p>Pre-crash safety system warning light (vehicles with optitron type meters)*1 Indicates a malfunction in the pre-crash safety system. The warning light will operate as follows, even when the system is not malfunctioning:</p> <ul style="list-style-type: none"> • The light will flash quickly when the system is operating. (→P. 380) • The light will turn on when the pre-crash braking is disabled. (→P. 381) • The light will turn on when the system cannot temporarily be used. (→P. 727)

5-2. Steps to take in an emergency

Warning light	Warning light/Details
	<p>Slip indicator light Indicates a malfunction in:</p> <ul style="list-style-type: none"> • Vehicle Stability Control; • Active TRC*^{1,2}; <p>The indicator will blink when the system listed above or below is operational. (→P. 374)</p> <ul style="list-style-type: none"> • Down Hill assist Control*^{1,2}; • Hill-start Assist Control*^{1,2}; or • Crawl Control*^{1,2}.
	<p>Automatic transmission fluid temperature warning light (vehicles with an automatic transmission) (vehicles with non-optitron type meters)</p> <ul style="list-style-type: none"> • Indicates that the automatic transmission fluid temperature is too high if the light comes on. Stop the vehicle in a safe place, shift the shift lever to P and wait until the light goes off. If the light goes off, you may start the vehicle again. • Indicates a malfunction in the automatic transmission system if the light flashes.
	<p>KDSS warning light*¹ Indicates a malfunction in KDSS</p>
	<p>Timing belt replacement warning light (vehicles with non-optitron type meters)*³ Indicates that the timing belt should be replaced.</p>
	<p>Fuel filter warning light (vehicles with non-optitron type meters)*³ (warning buzzer)*¹ Indicates that the amount of accumulated water in the fuel filter has reached the specified level</p>

Warning light	Warning light/Details
	<p>Fuel system warning light (vehicles with non-optitron type meters)^{*3} (warning buzzer)^{*1,4}</p> <p>Indicates:</p> <ul style="list-style-type: none"> • The amount of accumulated water in the fuel filter has reached the specified level if the light flashes. • Malfunction in the fuel system if the light comes on.
	<p>DPF system warning light (vehicles with non-optitron type meters)^{*1}</p> <p>Indicates:</p> <ul style="list-style-type: none"> • The amount of accumulated deposit in the DPF catalytic converter has reached the specified level if the light comes on. <p>Regenerate the filter. (→P. 716)</p> <ul style="list-style-type: none"> • Malfunction in the Diesel Particulate Filter system if the light flashes.

*1: If equipped

*2: Refer to the "Off-road Driving Owner's Manual"

*3: 1KD-FTV models (if equipped)



*4: The buzzer will sound at the same time the warning light flashes.



FarmaSOS.com

5-2. Steps to take in an emergency

Follow the correction procedures.



After taking the specified steps to correct the suspected problem, check that the warning light goes off.

Warning light	Warning light/Details	Correction procedure
	Open door warning light (warning buzzer)*1 Indicates that a door or glass hatch is not fully closed.	Check that all doors or glass hatch are closed.
	Low fuel level warning light Vehicles without sub fuel tank: Indicates that remaining fuel is about 13.0 L (3.4 gal., 2.8 Imp.gal.) or less if the light comes on. Vehicles with sub fuel tank*2: Indicates that remaining fuel is about 22.0 L (5.8 gal., 4.8 Imp.gal.) or less if the light comes on. 1KD-FTV models with sub fuel tank*2 only: Indicates that remaining fuel is about 22.0 L (5.8 gal., 4.8 Imp.gal.) or less if the light flashes.	Refuel the vehicle.

Warning light	Warning light/Details	Correction procedure
	Driver's seat belt reminder light (warning buzzer)*3 Warns the driver to fasten his/her seat belt.	Fasten the seat belt.
 (On the center panel)	Front passenger's seat belt reminder light (warning buzzer)*3 Warns the front passenger to fasten his/her seat belt.	Fasten the seat belt.
	Master warning light (vehicles with an optitron type meters) A buzzer sounds and the warning light comes on or flashes to indicate that the master warning system has detected a malfunction.	→P. 718

FarmaSOS.com

5-2. Steps to take in an emergency

Warning light	Warning light/Details	Correction procedure
	<p>Low engine oil level warning light (vehicles with non-optitron type meters)*2</p> <p>Indicates that engine oil level is low</p>	<p>Check the level of engine oil and add more oil if necessary.</p>
 (Flashes)	<p>Engine oil change reminder light (vehicles with non-optitron type meters) (diesel engine)</p> <p>Indicates that the engine oil is scheduled to be changed</p> <p>Flashes approximately 25000 km (15000 miles) after the engine oil is changed (the indicator will not work properly unless the oil maintenance data has been reset)</p>	<p>Check the engine oil and change if necessary. After changing the engine oil, the oil change system should be reset. (→P. 630)</p>

FarmaSOS.com

Warning light	Warning light/Details	Correction procedure
 (Remains on)	Engine oil change reminder light (vehicles with non-optitron type meters) (diesel engine) Indicates that the engine oil should be changed Comes on approximately 30000 km (20000 miles) after the engine oil has been changed (and the oil maintenance data has been reset)	Have the engine oil and oil filter checked and/or changed by any authorized Toyota dealer or repairer, or another duly qualified and equipped professional. After changing the engine oil, the oil change system should be reset. (→P. 630)

*1: Open door warning buzzer:

The open door warning buzzer sounds to alert one or more of the doors is not fully closed (with the vehicle having reached a speed of 5 km/h [3 mph]).

*2: If equipped

*3: Driver's and front passenger's seat belt reminders:

The driver's and front passenger's seat belts reminder sounds to alert the driver and front passenger that his/her seat belt is not fastened. The buzzer sounds for 30 seconds after the vehicle has reached a speed of at least 20 km/h (12 mph). Then, if the seat belt is still unfastened, the buzzer will sound in a different tone for 90 more seconds.



5-2. Steps to take in an emergency

Follow the correction procedures. (Smart entry & start system warning light and buzzer) (vehicles with non-optitron type meters)



After taking the specified steps to correct the suspected problem, check that the warning light turns off.

Interior buzzer	Exterior	Warning light	Details	Correction procedure
Continuous	Continuous		Indicates that the driver's door was opened and closed while the electronic key was not in the vehicle, the shift lever was not in P (automatic transmission) or N (manual transmission) and the "ENGINE START STOP" switch was not turned off.	<ul style="list-style-type: none"> • Shift the shift lever to P. • Bring the electronic key back into the vehicle.

FarmaSOS.com

Interior buzzer	Exterior	Warning light	Details	Correction procedure
Sounds once	3 times		Indicates that the driver's door has been opened or closed with the "ENGINE START STOP" switch in any mode other than OFF, the shift lever was in P (automatic transmission) or N (manual transmission) and the electronic key outside of the detection area.	<ul style="list-style-type: none"> • Turn the "ENGINE START STOP" switch off. • Bring the electronic key back into the vehicle.
Sounds once	Sounds once for 5 seconds	 (Comes on for about 60 seconds.)	Indicates that the "ENGINE START STOP" switch in any mode other than OFF, the shift lever was in P (vehicles with an automatic transmission), the electronic key outside of the detection area and attempt to lock the vehicle with smart entry & start system.	<ul style="list-style-type: none"> • Turn the "ENGINE START STOP" switch off. • Bring the electronic key back into the vehicle.

5-2. Steps to take in an emergency

Interior buzzer	Exterior	Warning light	Details	Correction procedure
Sounds once	Sounds 3 times		Indicates that a door other than the driver's door has been opened or closed with the "ENGINE START STOP" switch in any mode other than OFF, the shift lever was in P (automatic transmission) or N (manual transmission) and the electronic key outside of the detection area.	<ul style="list-style-type: none"> • Turn the "ENGINE START STOP" switch off. • Bring the electronic key back into the vehicle.
Sounds once	—		Indicates the electronic key is not present when attempting to start the engine.	Confirm the location of the electronic key

تلفن شبانه روزی: ۰۲۱-۸۸۶۲۰۸۵

FarmaSOS.com

■ If the malfunction indicator lamp comes on while driving

For some models, the malfunction indicator lamp will come on if the fuel tank becomes completely empty. If the fuel tank is empty, refuel the vehicle immediately. The malfunction indicator lamp will go off after several trips.

If the malfunction indicator lamp does not go off, contact any authorized Toyota dealer or repairer, or another duly qualified and equipped professional.

■ If the low speed four-wheel drive indicator light or the center differential lock indicator light blinks

Take the specified steps. (→Refer to the “Off-road Driving Owner’s Manual”)

■ Front passenger detection sensor and passenger seat belt reminder

- If luggage is placed on the front passenger seat, the front passenger detection sensor may cause the warning light to flash, even if a passenger is not sitting in the seat.

- If a cushion is placed on the seat, the sensor may not detect a passenger, and the warning light may not operate properly.

■ Engine oil change reminder light (diesel engine only)

Replace the engine oil and oil filter when the engine oil change reminder light does not come on even if 24 months have passed or you have driven over 30000 km (18000 miles) after the engine oil was changed.

There is a possibility that the engine oil change reminder light has been illuminated when you have driven less than 30000 km (18000 miles) based on a usage or driving condition.

5-2. Steps to take in an emergency

■ If the DPF system warning light comes on

The deposit collected in the filter needs to be regenerated.

To regenerate the filter, the following driving methods are recommended*:

- By driving continuously (for example, at around 60 km/h [36 mph] for approximately 20 minutes).
- By avoiding short trips, or by driving continuously (leaving the engine running for long periods of time).

The DPF warning light will extinguish when regeneration is complete. However, if this driving cannot be carried out, or if the light does not extinguish even after driving, have the vehicle inspected by any authorized Toyota dealer or repairer, or another duly qualified and equipped professional immediately.

For details of the DPF system, refer to P. 389.

*: When driving, pay sufficient attention to weather, road conditions, terrain and traffic conditions, and drive according to traffic laws.

■ Customization

The vehicle speed linked seat belt reminder buzzer can be disabled.

(Customizable features →P. 849)

تلفن شبانه روزی: ۰۸۵-۸۸۶۲-۰۲۱

FarmaSOS.com

 CAUTION

■ **If both the ABS and the brake system warning lights remain on**

Stop your vehicle in a safe place immediately and contact any authorized Toyota dealer or repairer, or another duly qualified and equipped professional. The vehicle will become extremely unstable during braking, and the ABS system may fail, which could cause an accident resulting in death or serious injury.

■ **When the power steering system warning light comes on**

The steering wheel may become extremely heavy.
If the steering wheel becomes heavier than usual when operating, hold firmly and operate using more force than usual.

 NOTICE

■ **If the fuel filter warning light comes on**

Never drive the vehicle with the warning light on. Continued driving with water accumulated in the fuel filter will damage the fuel injection pump.

FarmaSOS.com

5-2. Steps to take in an emergency

If a warning message is displayed*

For vehicles with optitron type meters: The multi-information display shows warnings of system malfunctions, incorrectly performed operations, or shows messages that indicate a need for maintenance.

If a warning is shown on the multi-information display, stay calm and perform the following actions:

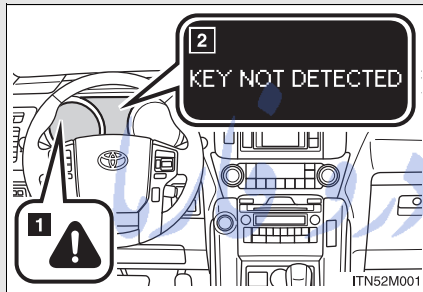

1 Master warning light

The master warning light also comes on or flashes in order to indicate that a message is currently being displayed on the multi-information display.

2 Multi-information display



If any of the warning lights comes on again after the following actions have been performed, contact any authorized Toyota dealer or repairer, or another duly qualified and equipped professional.

FarmaSOS.com

*: If equipped

Stop the vehicle immediately.

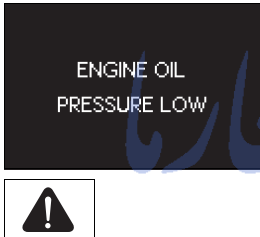



A buzzer sounds and a warning message is shown on the multi-information display. The following warning indicates the possibility of damage to the vehicle that may lead to an accident. Immediately stop the vehicle in a safe place and contact any authorized Toyota dealer or repairer, or another duly qualified and equipped professional.





Warning message	Details
 <p>ENGINE OIL PRESSURE LOW</p> 	<p>Indicates abnormal engine oil pressure The warning light may come on if the engine oil pressure is too low.</p>

Have the vehicle inspected immediately.



A buzzer sounds and a warning message is shown on the multi-information display. Failure to investigate the cause of the following warnings may lead to the system operating abnormally and possibly cause an accident. Have the vehicle inspected by any authorized Toyota dealer or repairer, or another duly qualified and equipped professional immediately.

5-2. Steps to take in an emergency

Warning message	Details
<p data-bbox="381 506 636 674">HIGH AUTOMATIC TRANSMISSION FLUID TEMP. STOP VEHICLE IN A SAFE PLACE</p>  <p data-bbox="435 741 578 772">(If equipped)</p>	<p data-bbox="667 558 1227 617">Indicates that the automatic transmission fluid temperature is too high</p> <p data-bbox="667 621 1203 716">Stop the vehicle in a safe place, shift the shift lever to P and wait until the light goes off. If the light goes off, you may start the vehicle again.</p>
<p data-bbox="381 798 636 966">CHECK TRANSMISSION SYSTEM</p>  <p data-bbox="435 1033 578 1064">(If equipped)</p>	<p data-bbox="667 896 1146 955">Indicates a malfunction in the automatic transmission system</p>
<p data-bbox="381 1089 636 1257">CHECK STEERING LOCK SYSTEM</p> 	<p data-bbox="667 1173 1187 1232">Indicates a malfunction in the steering lock system</p>
<p data-bbox="381 1354 636 1522">CHECK AIR SUSPENSION SYSTEM</p>  <p data-bbox="435 1589 578 1621">(If equipped)</p>	<p data-bbox="667 1451 1219 1509">Indicates a malfunction in the rear height control air suspension system</p>



Warning message	Details
<p data-bbox="383 506 636 667">CHECK PCS SYSTEM</p> <p data-bbox="383 680 586 737">PCS (Flashes)</p> <p data-bbox="383 749 578 840">  (If equipped) </p>	<p data-bbox="667 638 1224 699">Indicates a malfunction in the pre-crash safety system</p>
<p data-bbox="383 869 636 1031">CHECK SONAR SYSTEM</p> <p data-bbox="383 1043 578 1134">  (If equipped) </p>	<p data-bbox="667 932 1208 993">Indicates a malfunction in the parking assist-sensor</p> <p data-bbox="680 999 1211 1060">The malfunctioning sensor is shown flashing on the display.</p>
<p data-bbox="383 1163 636 1325">CHECK CRUISE CONTROL SYSTEM</p> <p data-bbox="383 1337 586 1398">  (Flashes) or </p> <p data-bbox="383 1411 586 1472">  (Flashes) </p> <p data-bbox="383 1484 578 1575">  (If equipped) </p>	<p data-bbox="667 1283 1235 1344">Indicates a malfunction in the radar cruise control system</p> <p data-bbox="680 1350 1203 1440">Press the “ON-OFF” button once to deactivate the system, and then press the button again to reactivate the system.</p>

5-2. Steps to take in an emergency





Warning message	Details
<div data-bbox="380 501 638 667" style="background-color: black; color: white; padding: 5px; text-align: center;"> CHECK CLUTCH SWITCH </div> <div data-bbox="380 678 472 737" style="text-align: center;">  </div> <p data-bbox="435 737 578 764">(If equipped)</p>	<p data-bbox="667 600 1187 659">Indicates a malfunction in the clutch switch system</p>
<div data-bbox="380 795 638 961" style="background-color: black; color: white; padding: 5px; text-align: center;"> FUEL FILTER MAINTENANCE REQUIRED </div> <div data-bbox="380 972 472 1031" style="text-align: center;">  </div> <p data-bbox="435 1031 591 1058">(Diesel engine)</p>	<p data-bbox="667 909 1166 936">Indicates a malfunction in the fuel system</p>
<div data-bbox="380 1083 638 1249" style="background-color: black; color: white; padding: 5px; text-align: center;"> DPF FULL ENGINE SERVICE REQUIRED </div> <div data-bbox="380 1260 472 1318" style="text-align: center;">  </div> <p data-bbox="435 1318 578 1346">(If equipped)</p>	<p data-bbox="667 1182 1203 1241">Indicates a malfunction in the Diesel Particulate Filter system</p>

Follow the correction procedures.







A buzzer sounds and a warning message is shown on the multi-information display. After taking the specified steps to correct the suspected problem, check that the warning message goes off.

Warning message	Details	Correction procedure
<p>5-door models / 3-door models</p> 	<p>Indicates that one or more of the doors is not fully closed</p> <p>The system also indicates which doors are not fully closed.</p> <p>If the vehicle reaches a speed of 5 km/h (3 mph),  flashes and a buzzer sounds to indicate that the door(s) are not yet fully closed.</p>	<p>Make sure that all the doors are closed.</p>

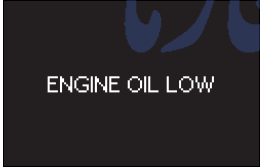

5-2. Steps to take in an emergency

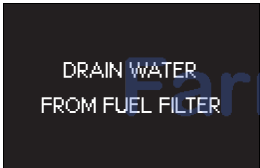
Warning message	Details	Correction procedure
 <p>(If equipped)</p>	<p>Indicates that the glass hatch is not fully closed</p> <p>If the vehicle reaches a speed of 5 km/h (3 mph),  flashes and a buzzer sounds to indicate that the glass hatch is not yet fully closed.</p>	<p>Close the glass hatch.</p>
  (Flashes) (If equipped)	<p>Indicates that the moon roof is not fully closed (with the “ENGINE START STOP” switch off, and the driver’s door open)</p>	<p>Close the moon roof.</p>



FarmaSOS.com

Warning message	Details	Correction procedure
	<p>Indicates that the parking brake is still engaged</p> <p>If the vehicle reaches a speed of 5 km/h (3 mph),  flashes and a buzzer sounds to indicate that the parking brake is still engaged.</p>	<p>Release the parking brake.</p>
 	<p>Indicates that engine oil level is low</p>	<p>Check the level of engine oil, and add if necessary.</p> <p>This message may appear if the vehicle is stopped on a slope. Move the vehicle to a level surface and check to see if the message disappears.</p>
  (Diesel engine)	<p>Indicates that the amount of accumulated water in the fuel filter has reached the specified level</p>	<p>Drain the water from the fuel filter. (→P. 643)</p>





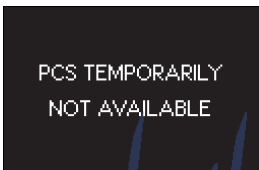

5-2. Steps to take in an emergency





Warning message	Details	Correction procedure
 <p>OIL MAINTENANCE REQUIRED SOON (Diesel engine)</p>	<p>Indicates that the engine oil is scheduled to be changed</p> <p>Comes on approximately 25000 km (15000 miles) after the engine oil is changed. (The indicator will not work properly unless the oil maintenance data has been reset.)</p>	<p>Check the engine oil and change if necessary. After changing the engine oil, the oil change system should be reset. (→P. 630)</p>
 <p>OIL MAINTENANCE REQUIRED (Diesel engine)</p>	<p>Indicates that the engine oil and oil filter should be changed</p>	<p>Have the engine oil and oil filter checked and/or changed by any authorized Toyota dealer or repairer, or another duly qualified and equipped professional. After changing the engine oil, the oil change system should be reset. (→P. 630)</p>

FarmaSOS.com

Warning message	Details	Correction procedure
 <p>T-BELT MAINTENANCE REQUIRED</p> <p>(Diesel engine)</p>	<p>Indicates that the timing belt is scheduled to be changed.</p>	<p>Have the timing belt checked and/or changed by any authorized Toyota dealer or repairer, or another duly qualified and equipped professional.</p>
 <p>PCS TEMPORARILY NOT AVAILABLE</p> <p>PCS (If equipped)</p>	<p>Indicates that the pre-crash safety system is not currently functional</p>	<ul style="list-style-type: none"> • Clean the grill and the sensor if they are dirty. • In case of overheating, the system will become functional once the system cools down.
 <p>CLEAN SONAR</p>  <p>(If equipped)</p>	<p>Indicates that parking assist-sensor is dirty or covered with ice A buzzer also sounds.</p>	<p>Clean the sensor.</p>

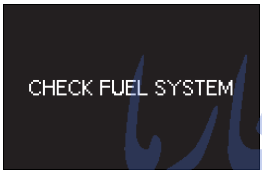
5-2. Steps to take in an emergency

Warning message	Details	Correction procedure
  (Flashes)  (If equipped)	<p>Indicates that the radar cruise control sensor is dirty or covered with ice</p> <p>A buzzer also sounds.</p>	<p>Clean the grill and the sensor if they are dirty.</p>
  (Flashes)  (If equipped)	<p>Indicates that the radar cruise control system is unable to judge vehicle-to-vehicle distance</p> <p>A buzzer also sounds.</p>	<p>If the windshield wipers are on, turn them off or set them to a mode other than "AUTO" or high speed wiper operation.</p>
 (Flashes) (If equipped)	<p>Indicates that your vehicle is nearing the vehicle ahead (in radar cruise mode)</p> <p>A buzzer also sounds.</p>	<p>Slow the vehicle by applying the brakes.</p>

Warning message	Details	Correction procedure
 PCS (Flashes) (If equipped)	Indicates that there is a high possibility of a frontal collision, or that the pre-crash braking function is operating A buzzer also sounds.	Slow the vehicle by applying the brakes.
  (Flashes)  (Diesel engine)*	Indicates that remaining fuel is approximately 22.0 L (5.8 gal., 4.8 Imp.gal.) or less A buzzer also sounds.	Refuel the vehicle.
 (If equipped)	Indicates the amount of accumulated deposit in the DPF catalytic converter has reached the specified level	Regenerate the filter. (→P. 741)

*: 1KD-FTV models with sub fuel tank only

5-2. Steps to take in an emergency

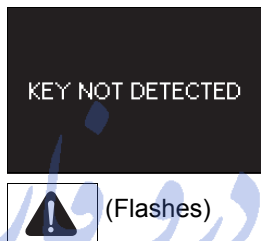

Have the malfunction repaired immediately.

After taking the specified steps to correct the suspected problem, check that the warning message and light go off.





Interior buzzer	Exterior buzzer	Warning message	Details	Correction procedure
Sounds once	—	 (Flashes)	The electronic key is not detected when an attempt is made to start the engine.	Confirm the location of the electronic key.

تلفن شبانه روزی: ۰۲۱-۸۸۶۲۰۸۵





FarmaSOS.com

Interior buzzer	Exterior buzzer	Warning message	Details	Correction procedure
Sounds once	Sounds 3 times	  (Flashes)	<p>The electronic key was carried outside the vehicle and a door other than the driver's door was opened and closed while the "ENGINE START STOP" switch was in a mode other than off.</p>	<p>Bring the electronic key back into the vehicle.</p>
			<p>The driver's door was opened and closed while the electronic key was not in the vehicle, the shift lever was in P (automatic transmission) or N (manual transmission) and the "ENGINE START STOP" switch was not turned off.</p>	<p>Turn the "ENGINE START STOP" switch off or bring the electronic key back into the vehicle.</p>

5-2. Steps to take in an emergency

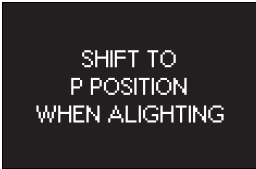
Interior buzzer	Exterior buzzer	Warning message	Details	Correction procedure
Sounds once	Sounds once for 5 seconds	  (Displayed alternately)  (Flashes)	An attempt was made to exit the vehicle with the electronic key and lock the doors without first turning the "ENGINE START STOP" switch off.	Turn the "ENGINE START STOP" switch off and lock the doors again.
Sounds once	—	  (Flashes)	An attempt was made to start the engine without the electronic key being present, or the electronic key was not functioning normally. An attempt was made to drive when the regular key was not inside the vehicle.	Confirm that the electronic key is inside the vehicle.

5-2. Steps to take in an emergency

Interior buzzer	Exterior buzzer	Warning message	Details	Correction procedure
Continuous	—	  (Flashes) (If equipped)	The driver's door was opened when the shift lever was not in P and the "ENGINE START STOP" switch was not turned off.	Shift the shift lever to P.
Continuous	Continuous	  (Displayed alternately)  (Flashes) (If equipped)	The driver's door was opened and closed while the electronic key was not in the vehicle, the shift lever was not in P and the "ENGINE START STOP" switch was not turned off.	<ul style="list-style-type: none"> • Shift the shift lever to P. • Bring the electronic key back into the vehicle.

5

When trouble arises

5-2. Steps to take in an emergency

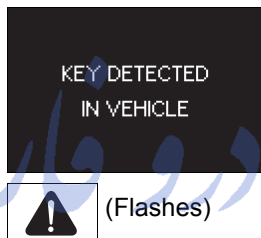



Interior buzzer	Exterior buzzer	Warning message	Details	Correction procedure
Sounds once	Sounds once for 5 seconds	 <p>(Flashes)</p>	<p>An attempt was made to lock the doors using the smart entry & start system while the electronic key was still inside the vehicle.</p> <p>An attempt was made to lock either front door by opening a door and putting the inside lock button into the lock position, then closing the door by pulling on the outside door handle with the electronic key still inside the vehicle.</p>	Retrieve the electronic key from the vehicle and lock the doors again.

FarmaSOS.com

Interior buzzer	Exterior buzzer	Warning message	Details	Correction procedure
Sounds once	—	<p>DEPRESS BRAKE PEDAL, TOUCH ENGINE SWITCH WITH KEY (automatic transmission)</p> <p>or</p> <p>DEPRESS CLUTCH PEDAL, TOUCH ENGINE SWITCH WITH KEY (manual transmission)</p> <p> (Flashes)</p>	<ul style="list-style-type: none"> When the doors were unlocked with the mechanical key and then the “ENGINE START STOP” switch was pressed, the electronic key could not be detected in the vehicle. The electronic key could not be detected in the vehicle even after the “ENGINE START STOP” switch was pressed two consecutive times. 	Touch the electronic key to the “ENGINE START STOP” switch while depressing the brake pedal (automatic transmission) or clutch pedal (manual transmission).

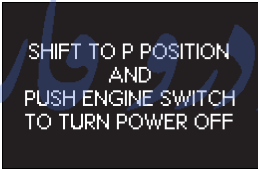

FarmaSOS.com

5-2. Steps to take in an emergency

Interior buzzer	Exterior buzzer	Warning message	Details	Correction procedure
Sounds once	—	  (Flashes)	An attempt was made to start the engine with the shift lever in an incorrect position.	Shift the shift lever to P and start the engine.
Sounds once	—	  (Flashes)	An attempt was made to turn the “ENGINE START STOP” switch off when the shift lever was not in P.	To turn off the engine, first shift the shift lever to P and then turn the “ENGINE START STOP” switch off.

FarmaSOS.com



5-2. Steps to take in an emergency

Interior buzzer	Exterior buzzer	Warning message	Details	Correction procedure
—	—		Power was turned off due to the automatic power off function.	Next time when starting the engine, increase the engine speed slightly and maintain that level for approximately 5 minutes to recharge the battery.
Sounds once	—	 	The electronic key has a low battery. (The message will be shown for about 15 seconds.)	Replace the electronic key battery. (→P. 656)

5

When trouble arises

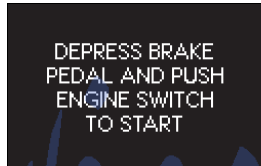
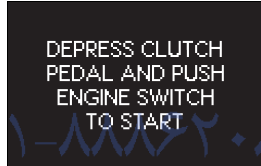
5-2. Steps to take in an emergency

Interior buzzer	Exterior buzzer	Warning message	Details	Correction procedure
Sounds once	—	 (automatic transmission)	The driver's door was opened and closed with the "ENGINE START STOP" switch turned off and then the "ENGINE START STOP" switch was put in ACCESSORY mode twice without the engine being started.	Press the "ENGINE START STOP" switch while depressing the brake pedal (automatic transmission) or clutch pedal (manual transmission).
		 (manual transmission)		
		 (Flashes)		

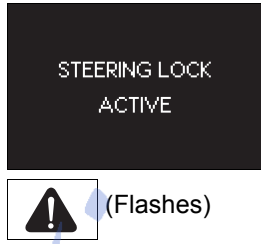
Interior buzzer	Exterior buzzer	Warning message	Details	Correction procedure
Sounds once	—	 <p>STEERING LOCK ACTIVE</p> <p>(Flashes)</p>	The steering lock could not be released within 3 seconds of the “ENGINE START STOP” switch being pressed.	Press the “ENGINE START STOP” switch while depressing the brake pedal and moving the steering wheel left and right.

تلفن شبانه روزی: ۰۲۱-۸۸۶۲۰۸۵

FarmaSOS.com

5-2. Steps to take in an emergency

Other messages

If the following message is displayed, take appropriate action and confirm that the message has disappeared.

(→Refer to the “Off-road Driving Owner’s Manual”)

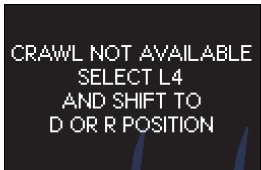
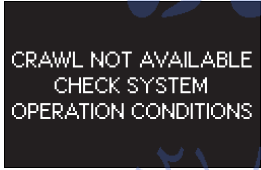
Message	Correction procedure
 (If equipped)	Select the four-wheel driving position switch in L4 and shift the shift lever to D or R.
 (If equipped)	Confirm the operating conditions.

FarmaSOS.com

■ **Warning light display in radar cruise mode (if equipped)**

In the following cases, the warning light may not be displayed even if vehicle-to-vehicle distance decreases:

- When your vehicle and the vehicle ahead are traveling at the same speed or the vehicle ahead is traveling more quickly than your vehicle
- When the vehicle ahead is traveling at a very low speed
- Immediately after cruise control speed is set
- At the instant the accelerator pedal is depressed

■ **After changing the engine oil (Diesel engine)**

Make sure to reset the oil maintenance data. (→P. 630)

■ **If the message “DPF FULL SEE OWNER’S MANUAL” appears on the display**

The deposit collected in the filter needs to be regenerated.

To regenerate the filter, the following driving methods are recommended*:

- By driving continuously (for example, at around 60 km/h [36 mph] for approximately 20 minutes).
- By avoiding short trips, or by driving continuously (leaving the engine running for long periods of time).

The warning message will disappear when regeneration is complete. However, if this driving cannot be carried out, or if the message does not disappear even after driving, have the vehicle inspected by any authorized Toyota dealer or repairer, or another duly qualified and equipped professional immediately.

For details of the DPF system, refer to P. 389.

*: When driving, pay sufficient attention to weather, road conditions, terrain and traffic conditions, and drive according to traffic laws.

 NOTICE

■ **While the engine oil level warning is displayed**

Continued engine operation with low engine oil will damage the engine.

■ **Engine oil maintenance message (diesel engine)**

The warning message is based on the projected driving range after engine oil maintenance message is reset.

The system does not monitor the purity of the engine oil.

امداد خودرو فارما

تلفن شبانه روزی: ۰۲۱-۸۸۸۶۲۰۸۵

FarmaSOS.com

5-2. Steps to take in an emergency

If you have a flat tire (vehicles with a standard spare tire)*

Remove the flat tire and replace it with the spare provided.

■ **Before jacking up the vehicle**

- Stop the vehicle on a hard, flat surface.
- Set the parking brake.
- Shift the shift lever to P (automatic transmission) or R (manual transmission).
- Turn off the rear height control air suspension (if equipped). (→Refer to the “Off-road Driving Owner’s Manual”)
- Stop the engine.
- Turn on the emergency flashers. (→P. 692)

تلفن شبانه روزی: ۰۲۱-۸۸۸۶۲۰۸۵

FarmaSOS.com

5

When trouble arises

*: If equipped

743

5-2. Steps to take in an emergency

■ Location of the spare tire, jack and tools

Vehicles with under floor mounted spare tire

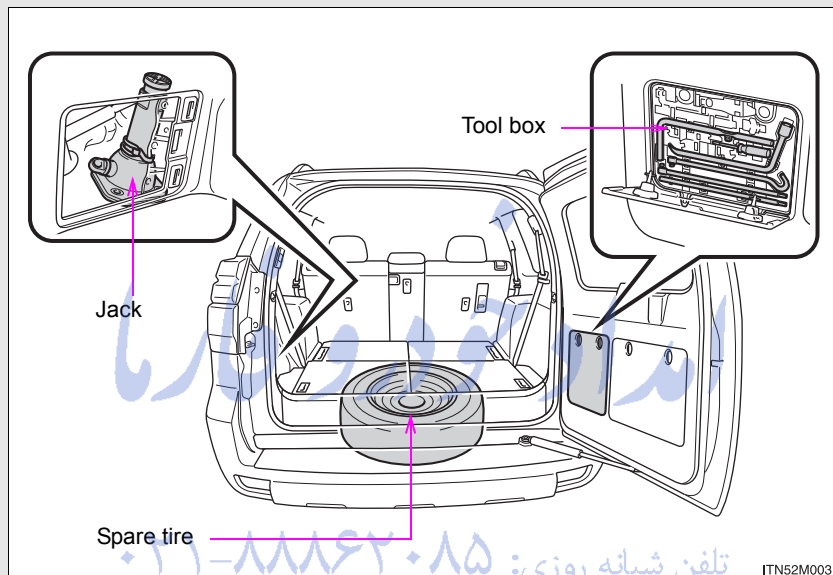

FarmaSOS.com

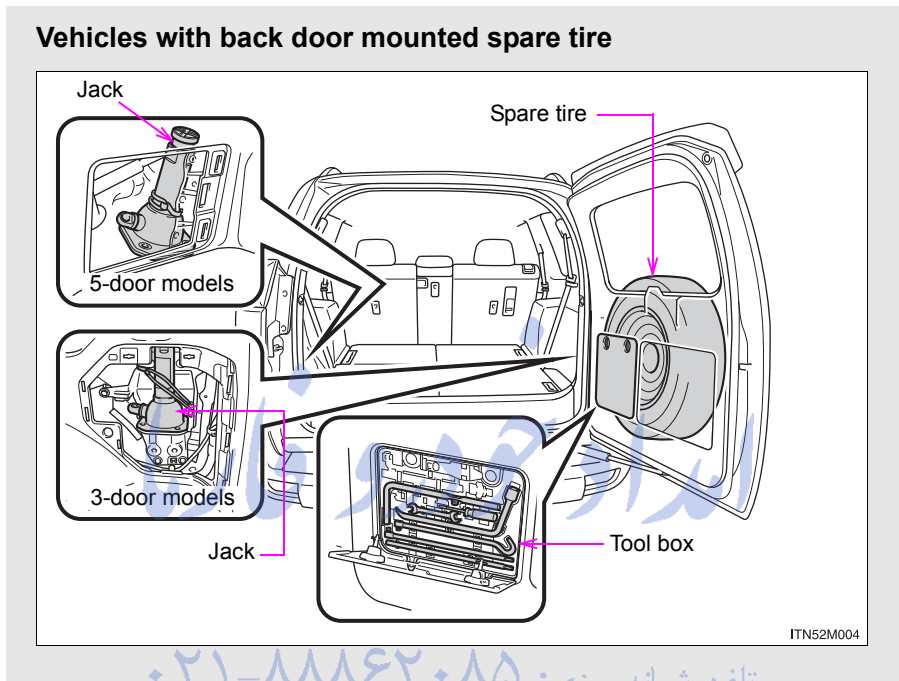

تلفن شبانه روزی: ۰۲۱-۸۸۸۶۲۰۸۵

FarmaSOS.com

5-2. Steps to take in an emergency

Taking out the jack

5-door models

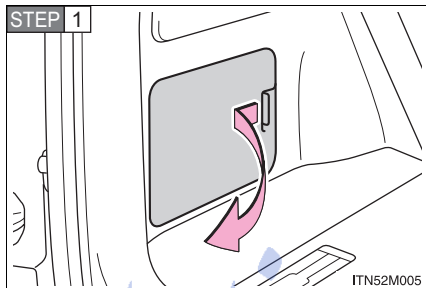

Remove the cover.

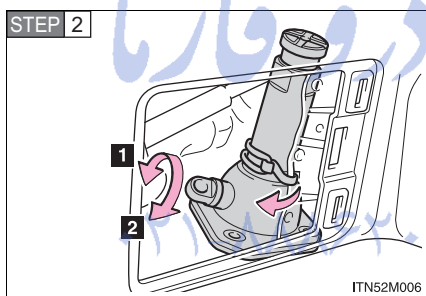

Unhook the rubber band and take out the jack.

- 1** For loosening
- 2** For tightening

FarmaSOS.com

3-door models

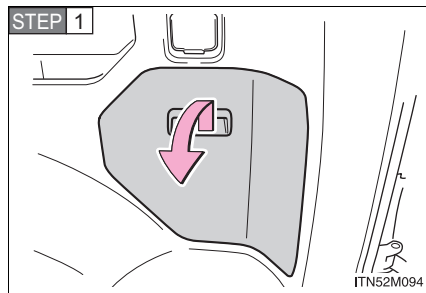

Remove the cover.

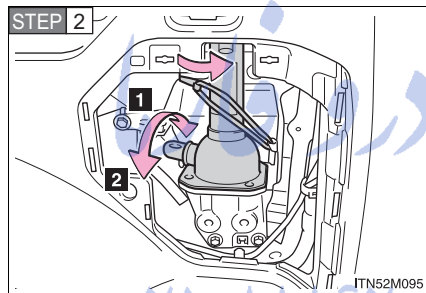

Unhook the rubber band and take out the jack.

- 1 For loosening
- 2 For tightening

تلفن شبانه روزی: ۰۲۱-۸۸۶۲۰۸۵

FarmaSOS.com

5-2. Steps to take in an emergency

Taking out the tool box

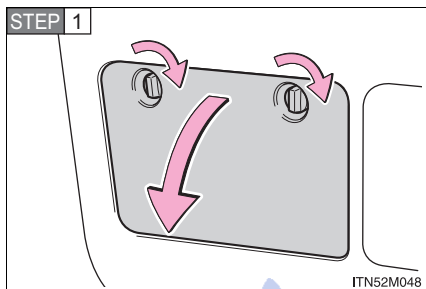

Open the cover.

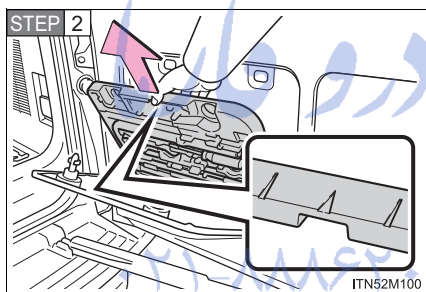

Take out the tool box.

FarmaSOS.com

Taking out the spare tire

Vehicles with back door mounted spare tire

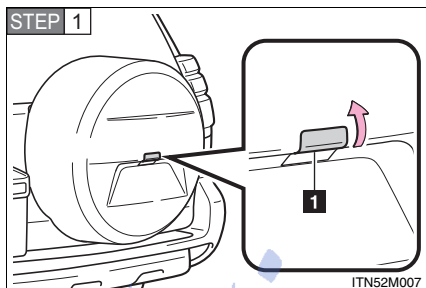

Remove the bolt cover

1 Bolt cover

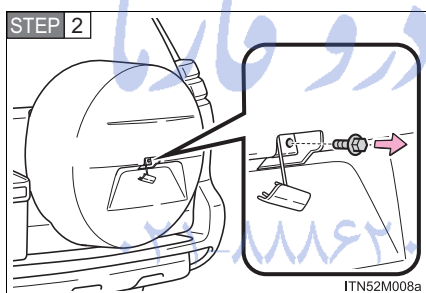

Remove the bolt which fixes the spare wheel cover.

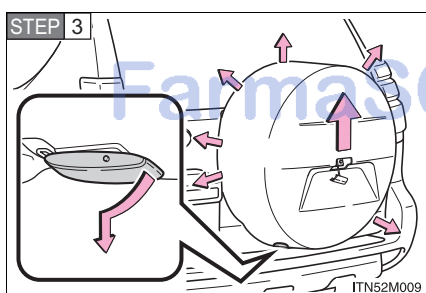

Disengage the craws and remove the spare wheel cover.

5

When trouble arises

5-2. Steps to take in an emergency

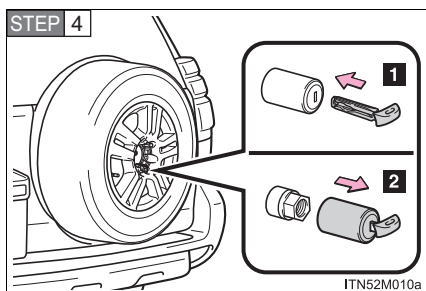

Unlock the spare tire lock system.

- 1** Insert the key into the cylinder.
- 2** Remove the key and the cylinder.

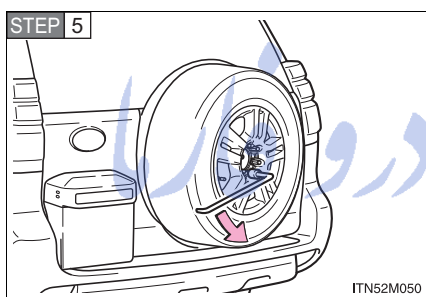

Turn the hold-down nuts counterclockwise with the wheel nut wrench and remove them.

تلفن شبانه روزی: ۰۲۱-۸۸۶۲۰۸۵

FarmaSOS.com

Vehicles with under floor mounted spare tire

STEP 1 Assembling the jack handle.

Remove the jack handle extension bar from the tool box and assemble by following these steps.

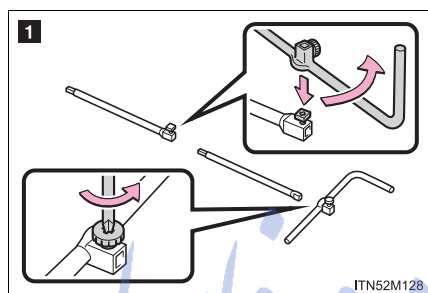

ITN52M128

- 1 Loosen the bolt and the screw using either the jack handle end or a screwdriver.

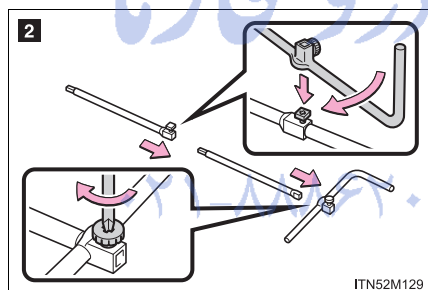

ITN52M129

- 2 Assemble the jack handle extension bar and the jack handle and tighten the bolt and the screw.

Check that the bolt and screw are firmly tightened.

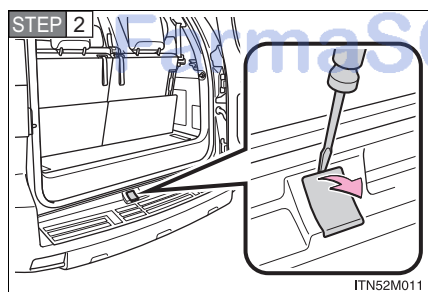

ITN52M011

Remove the cover.

5-2. Steps to take in an emergency

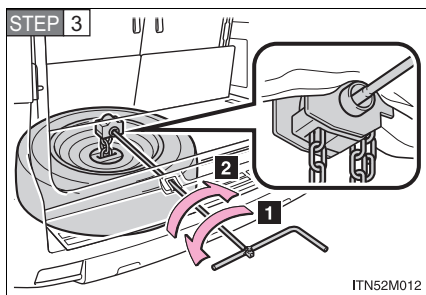

Insert the jack handle extension into the lowering screw.

1 Lower

2 Raise

Place a rag under the jack handle extension to protect the back door.

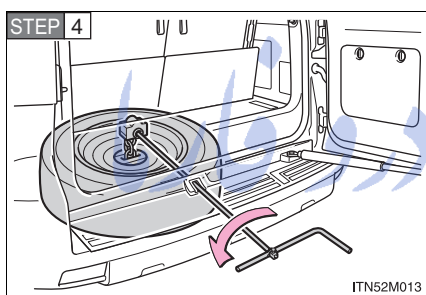

Lower the spare tire completely to the ground.

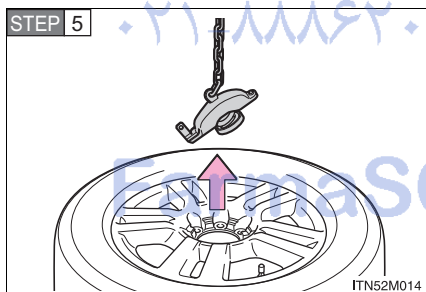

Pull out the spare tire and remove the holding bracket.

Replacing a flat tire

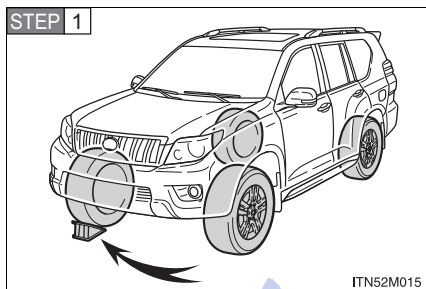

Check the tires.

	Flat tire	Wheel chock positions
Front	Left-hand side	Behind the rear right-hand side tire
	Right-hand side	Behind the rear left-hand side tire
Rear	Left-hand side	In front of the front right-hand side tire
	Right-hand side	In front of the front left-hand side tire

تلفن شبانه روزی: ۰۲۱-۸۸۶۲۰۸۵

FarmaSOS.com

5-2. Steps to take in an emergency

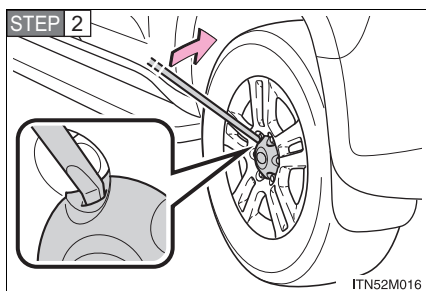

Pry off the wheel ornament, using the beveled end of the wheel ornament remover as shown.

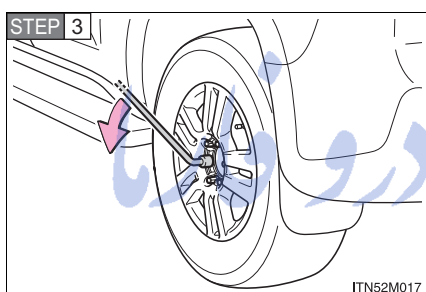

Slightly loosen the wheel nuts (one turn).

تلفن شبانه روزی: ۰۲۱-۸۸۶۲۰۸۵

FarmaSOS.com

STEP 4 Assembling the jack handle.

Remove the jack handle, jack handle extension bar and jack handle bar from the tool box and assemble by following these steps.

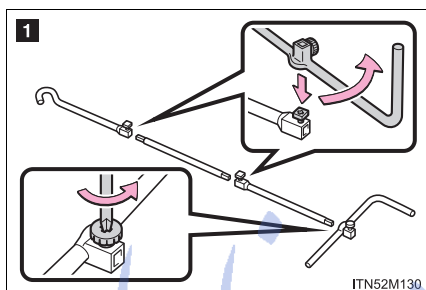

1 Loosen the bolt and the screw using either the jack handle end or a screwdriver.

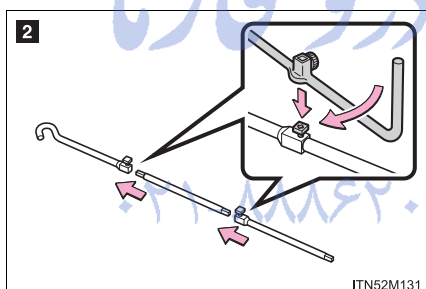

2 Assemble the jack handle extension bar and the jack handle bar and tighten the bolts.

Check that the bolts are firmly tightened. تلفن شبانه ۰۸۵۰۸۸۶۲۰۸۵

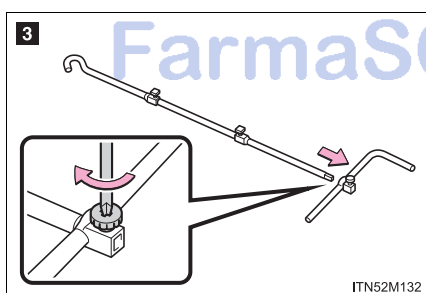

3 Assemble the jack handle extension bar and the jack handle and tighten the screw.

Check that the screw is firmly tightened.

5-2. Steps to take in an emergency

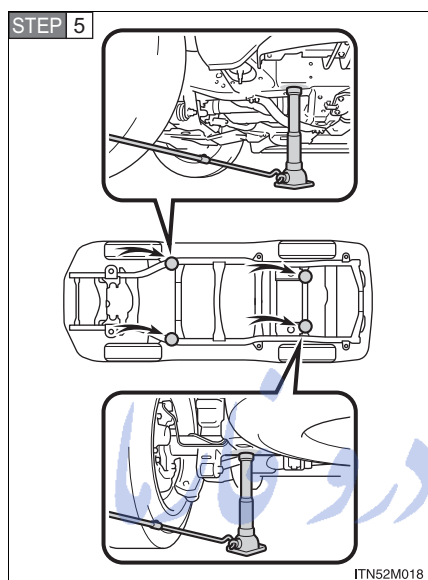

Position the jack at the jack points as shown.

Front - Under the chassis frame side rail

Rear - Under the rear axle housing

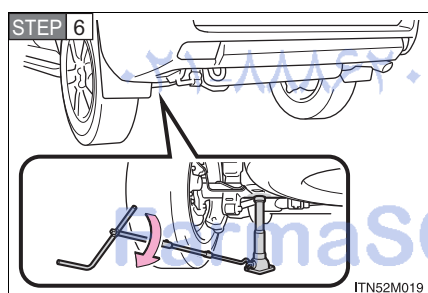

Raise the vehicle until the tire is slightly raised off the ground.

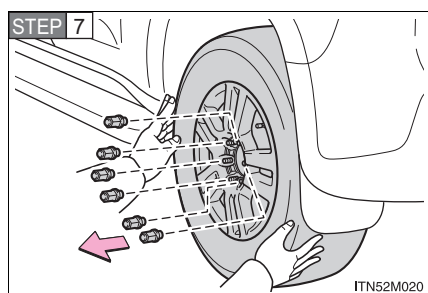

Remove all the wheel nuts and the tire.

When resting the tire on the ground, place the tire so that the wheel design faces up to avoid scratching the wheel surface.

Installing the spare tire

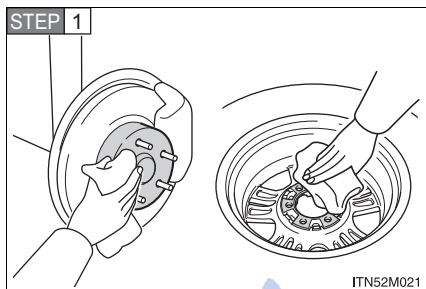

Remove any dirt or foreign matter from the wheel contact surface.

If foreign matter is on the wheel contact surface, the wheel nuts may loosen while the vehicle is in motion, and the tire to come off.

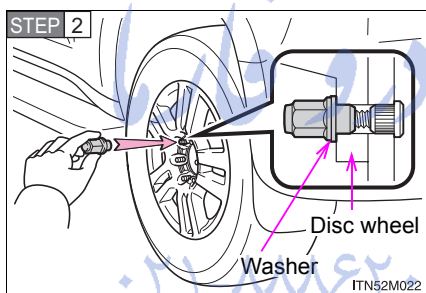

Install the spare tire and loosely tighten each nut by hand to approximately the same amount.

Turn the nut washers until they come into contact with the disc wheel.

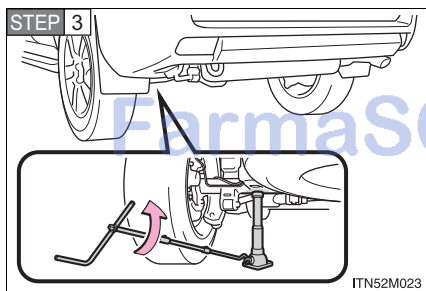

Lower the vehicle.

5-2. Steps to take in an emergency

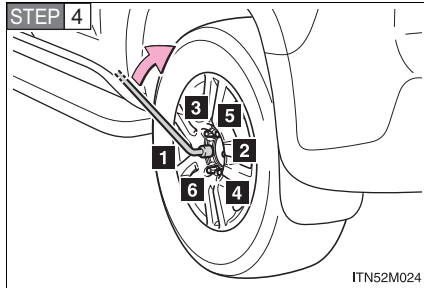

Firmly tighten each nut two or three times in the order shown in the illustration.

Tightening torque:
112 N•m (11.4 kgf•m, 83 ft•lbf)

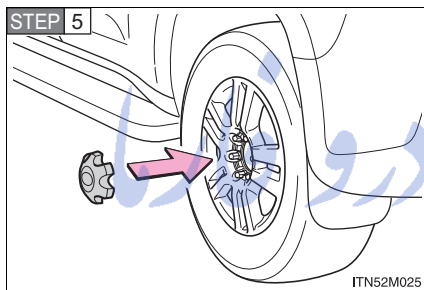

Reinstall the wheel ornament.

STEP 6 Stow the flat tire, tools and jack securely, and replace all covers.
تلفن شبانه روزی: ۰۸۵+۸۸۶۲-۲۱

Stowing the flat/spare tire, jack and tools

Vehicles with back door mounted spare tire

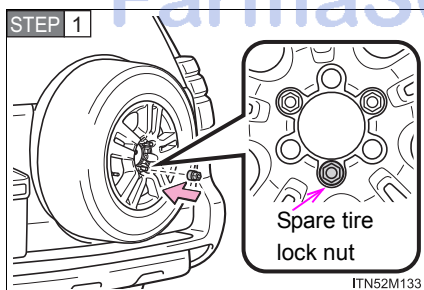

Install the tire and loosely tighten each nut by hand to approximately the same amount.

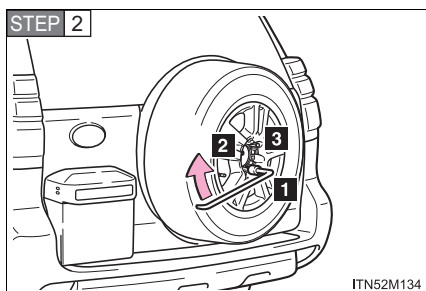

Firmly tighten each nut two or three times in the order shown in the illustration.

Tightening torque:
60 N•m (6.0 kgf•m, 44 ft•lbf)

Tighten the spare tire lock nut first.

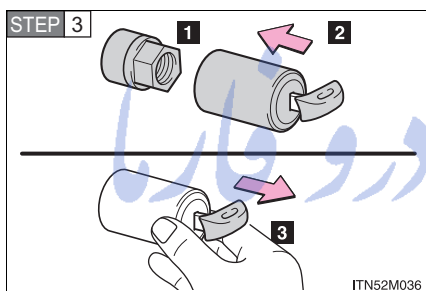

Lock the spare tire lock system

- 1** Spare tire lock nut.
- 2** Insert the key and cylinder.
- 3** Remove the key while holding the cylinder in place.

Check that the cylinder is locked securely.

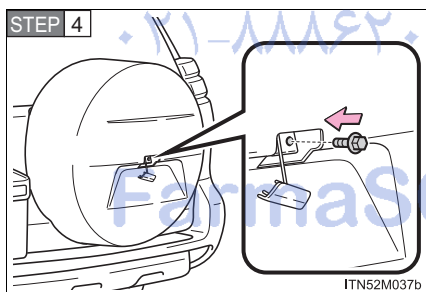

Install the spare wheel cover in the reverse order of removal.

Tightening torque:
14 N•m (1.4 kgf•m, 10 ft•lbf)

STEP 5 Stow the tools and jack securely, and replace all covers.

Vehicles with under floor mounted spare tire

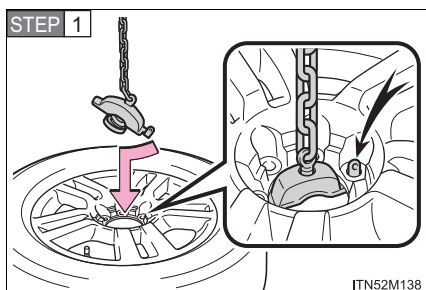

Lay down the tire with the outer side facing up, and install the holding bracket.

Insert the holding bracket tab into one of the holes in the wheel.

STEP 2 Raise the tire.

Vehicles with kinetic dynamic suspension: Pull the tire towards the rear of the vehicle when raising. After raising, visually check that the tire is not interfering with suspension components.

STEP 3 Stow the tools and jack securely, and replace all covers.

■ Vehicles with spare tire lock system (vehicles with back door mounted spare tire)

Use the spare tire lock nut only for the spare tire carrier.

FarmaSOS.com

■ Certification for the jack

Declaration of Conformity

Manufacturer: OKAYA&CO.,LTD. / TAKEUCHI INDUSTRIAL CO.,LTD.

EU Representative:

The EU Directives covered by this Declaration

1999/5/EC R &TTE Directive of the European Parliament and of the Council
2006/95/EC Low Voltage Directive

The product covered by the declaration

Model 1.8 t

The basis on which conformity is being declared

The product identified above complies with the requirements of Low Voltage Directive and R&TTE Directive above by meeting following standards.

ISO0901/JISD8103

The technical documentation required to demonstrate that the product meets the requirements of LVD and R&TTE has been compiled by the signatory below and is available for inspection by the relevant enforcement authorities.

A sample of the product has been tested by the manufacturer,

Technical File No: E-HA0296 / E-HA0297

The CE mark was first applied in 2010

Done at *January 26, 2010*

OKAYA&CO.,LTD.

Fumihiko Yoshida

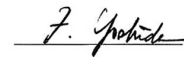

TAKEUCHI INDUSTRIAL CO.,LTD.

Masuo Takeuchi



 CAUTION

■ **Using the tire jack**

Improper use of the tire jack may cause the vehicle to suddenly fall off the jack, leading to death or serious injury.

- Do not use the tire jack for any purpose other than replacing tires or installing and removing tire chains.
- Only use the tire jack that comes with this vehicle for replacing a flat tire. Do not use it on other vehicles, and do not use other tire jacks for replacing tires on this vehicle.
- Always check that the tire jack is securely set to the jack point.
- Do not put any part of your body under the vehicle while it is supported by the jack.
- Do not start or run the engine while your vehicle is supported by the jack.
- Do not raise the vehicle while someone is inside.
- When raising the vehicle, do not put an object on or under the jack.
- Do not raise the vehicle to a height greater than that required to replace the tire.
- Use a jack stand if it is necessary to get under the vehicle.
- Vehicles with rear height control air suspension: Be sure to turn off the height control and stop the engine.

Take particular care when lowering the vehicle to ensure that no one working on or near the vehicle will be injured.

⚠ CAUTION**■ Using the jack handle**

Tighten all the jack handle bolts securely using a Phillips-head screwdriver, to prevent the extension parts from coming apart unexpectedly.

■ Replacing a flat tire

Observe the following precautions to reduce the risk of death or serious injury:

- Do not touch the disc wheels or the area around the brakes immediately after the vehicle has been driven.
After the vehicle has been driven the disc wheels and the area around the brakes will be extremely hot. Touching these areas with hands, feet or other body parts while changing a tire, etc. may result in burns.
- Vehicles with under floor mounted spare tire: Lower the spare tire completely to the ground before removing it from under the vehicle.
- Do not try to remove the wheel ornament by hand. Take due care in handling the ornament to avoid unexpected personal injury.
- Have the wheel nuts tightened with a torque wrench to 112 N•m (11.4 kgf•m, 83 ft•lbf) as soon as possible after changing wheels.
Failure to follow these precautions could cause the nuts to loosen and the wheel may fall off, which could lead to an accident causing death or serious injury.
- Do not attach a heavily damaged wheel ornament, as it may fly off the wheel while the vehicle is moving.
- When installing a tire, only use wheel nuts that have been specifically designed for that wheel.

 CAUTION

■ **Replacing a flat tire**

- If there are any cracks or deformations in the bolt screws, nut threads or bolt holes of the wheel, have the vehicle inspected by any authorized Toyota dealer or repairer, or another duly qualified and equipped professional.

Failure to follow these precautions could cause the wheel nuts to loosen and the tire to fall off, resulting in death or serious injury.

■ **When installing the wheel nuts**

Be sure to install the wheel nuts with the tapered end facing inward.
(→P. 653)

■ **After using the tools and jack**

Before driving, make sure all the tools and jack are securely in place in their storage location to reduce the possibility of personal injury during a collision or sudden braking.

 NOTICE

■ **Do not drive the vehicle with a flat tire.**

Do not continue driving with a flat tire.
Driving even a short distance with a flat tire can damage the tire and the wheel beyond repair.

■ **When stowing the flat tire (vehicles with under floor mounted spare tire)**

Ensure that there is no object caught between the tire and the vehicle underbody.

■ **When assembling the jack handle extension**

Tighten all the joints securely. Otherwise the extension may come off and it may damage the paint or vehicle body.

5-2. Steps to take in an emergency

If you have a flat tire (vehicles with an emergency tire puncture repair kit)*

Your vehicle is equipped with an emergency tire puncture repair kit. A puncture caused by a nail or screw passing through the tire tread can be repaired temporarily with the emergency tire puncture repair kit.

■ Before repairing the vehicle

- Stop the vehicle in a safe place on a hard, flat surface.
- Set the parking brake.
- Shift the lever to P (automatic transmission) or N (manual transmission).
- Turn off the rear height control air suspension (if equipped). (→Refer to the "Off-road Driving Owner's Manual")
- Stop the engine.
- Turn on the emergency flashers. (→P. 692)

تلفن شبانه روزی: ۰۲۱-۸۸۶۲۰۸۵

FarmaSOS.com

5

When trouble arises

*: If equipped

765

5-2. Steps to take in an emergency

■ Location of the emergency tire puncture repair kit, jack and tools

5-door models

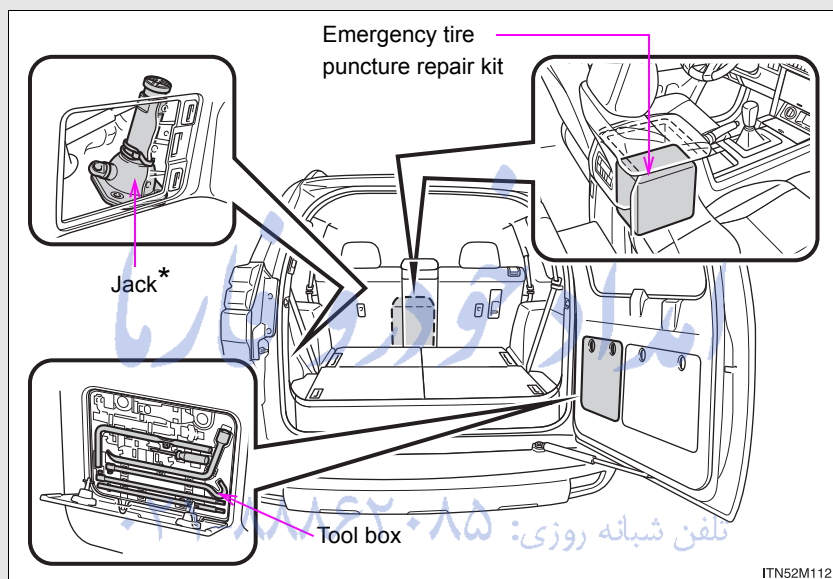

*: Use of the jack (→P. 756)

FarmaSOS.com

3-door models

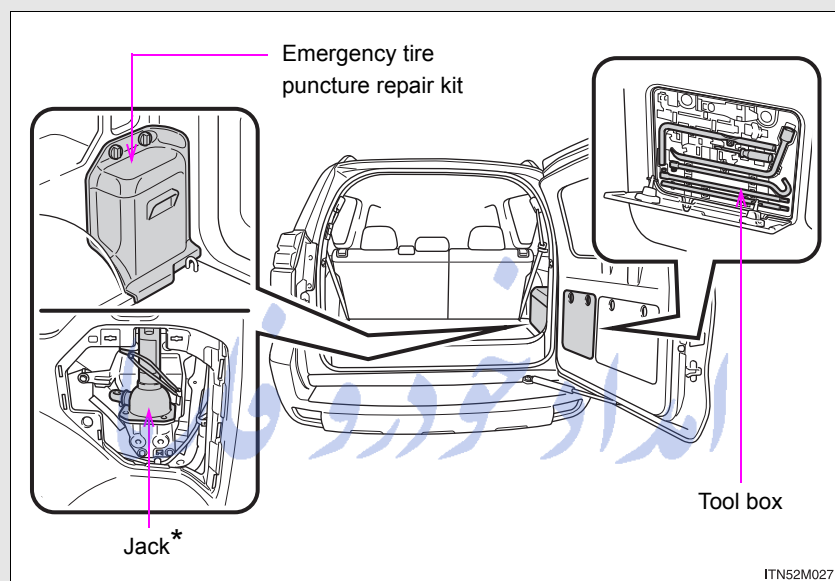

*: Use of the jack (→P. 756)

FarmaSOS.com

5-2. Steps to take in an emergency

■ Emergency tire puncture repair kit components

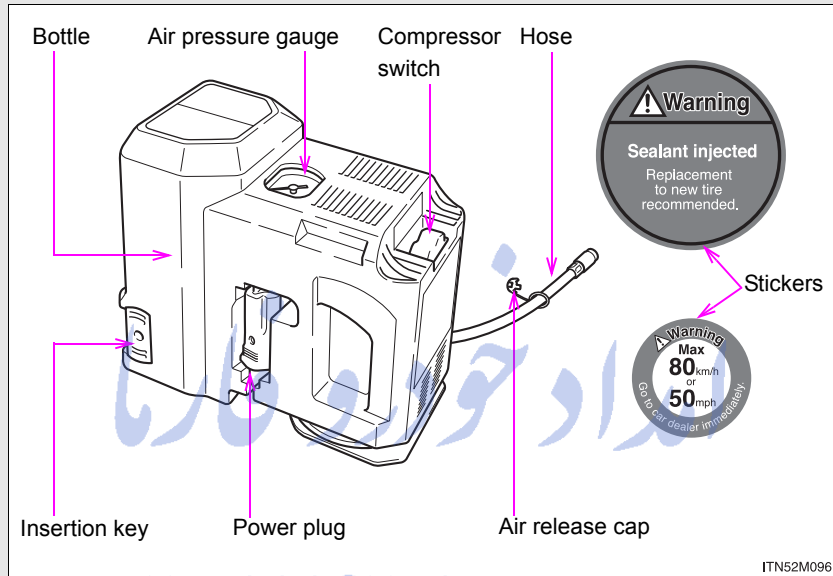

تلفن شبانه روزی: ۰۲۱-۸۸۸۶۲۰۸۵

FarmaSOS.com

Taking out the emergency tire puncture repair kit

5-door models

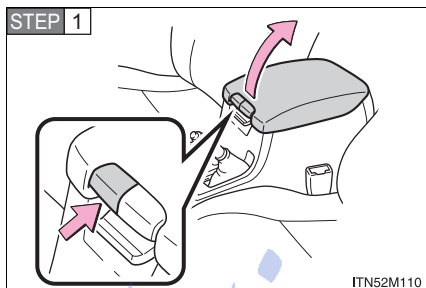

Open the console box.

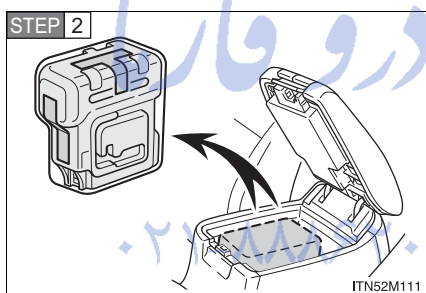

Take out the emergency tire puncture repair kit.

FarmaSOS.com

5-2. Steps to take in an emergency

3-door models

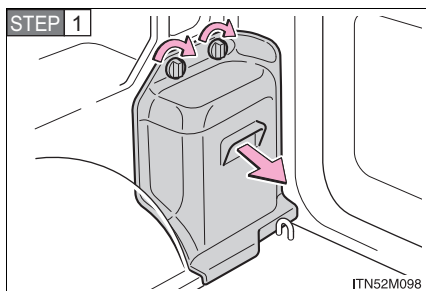

Remove the cover.

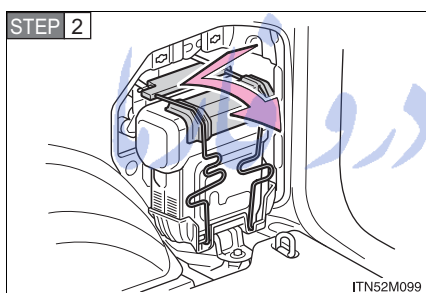

Take out the emergency tire puncture repair kit.

تلفن شبانه روزی: ۰۲۱-۸۸۶۲۰۸۵

FarmaSOS.com

Before performing emergency repair

Check the degree of the tire damage.

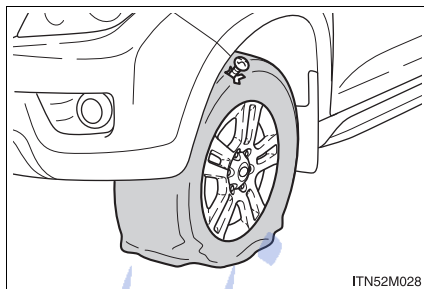

A tire should only be repaired with the emergency tire puncture repair kit if the damage is caused by a nail or screw passing through the tire tread.

- Do not remove the nail or screw from the tire. Removing the object may widen the opening and disenable emergency repair with the kit.
- To avoid sealant leakage, move the vehicle until the area of the puncture, if known, is positioned at the top of the tire.

ایران خودرو فارما
تلفن شبانه روزی: ۰۲۱-۸۸۶۲۰۸۵

FarmaSOS.com

5-2. Steps to take in an emergency

Emergency repair method

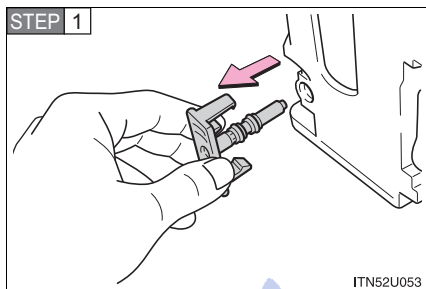

Pull the insertion key out of the kit.

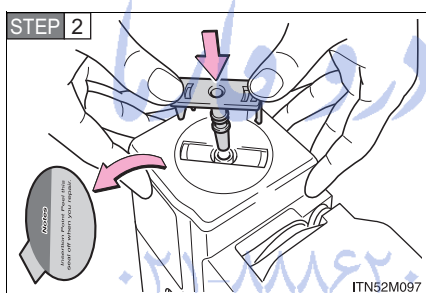

Place the kit with the bottom facing upward.

Peel off the label, and push in the insertion key until a click is heard.

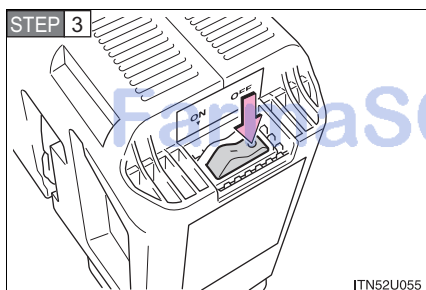

Return the kit to an upright position and make sure that the compressor switch is off.

Use the kit with the top facing upward.

STEP 4 Connect the power plug to the power outlet socket. (→P. 586)

Front

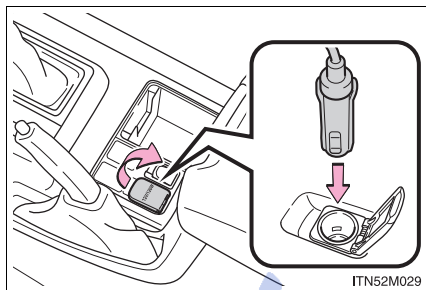

Open the cover and connect the power plug.

Rear

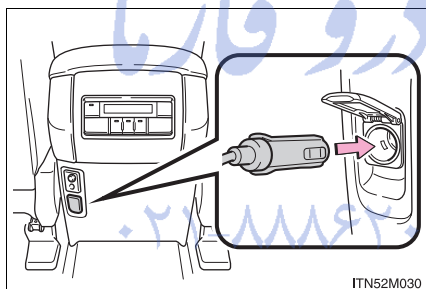

Luggage compartment (DC12 V)

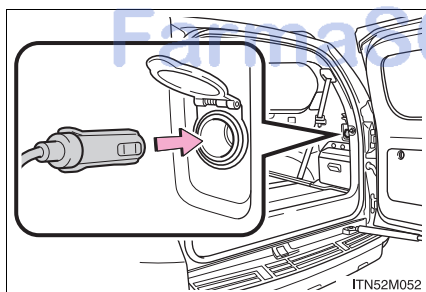

5-2. Steps to take in an emergency

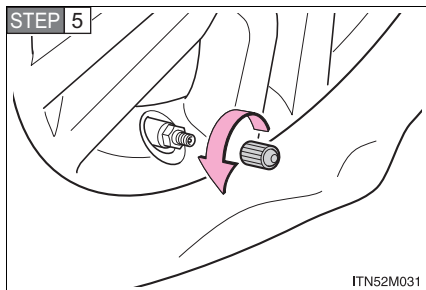

Remove the valve cap from the valve of the punctured tire.

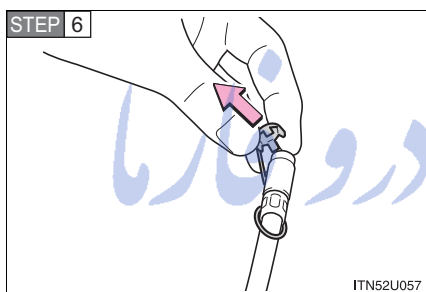

Remove the air release cap from the hose.

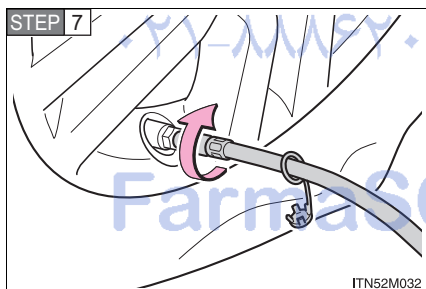

Connect the hose to the valve.
Screw the end of the hose clockwise as far as possible.

STEP 8 Check the specified tire inflation pressure.
The label is placed as shown in the illustration.

Left-hand drive vehicles

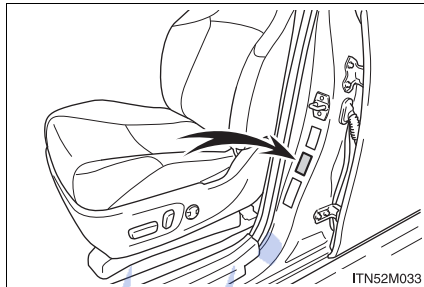

Right-hand drive vehicles

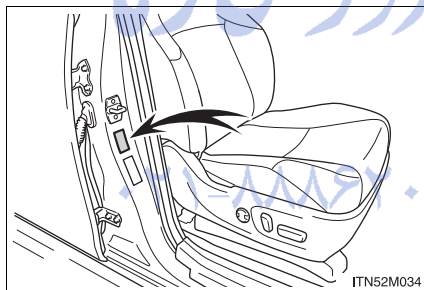

FarmaSOS.com

5-2. Steps to take in an emergency

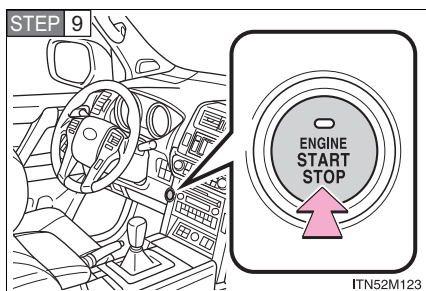

Start the engine.

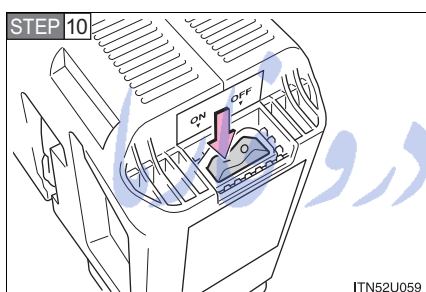

To inject the sealant and inflate the tire, turn the compressor switch on.

Use the kit with the top facing upward.

تلفن شبانه روزی: ۰۲۱-۸۸۶۲۰۸۵

FarmaSOS.com

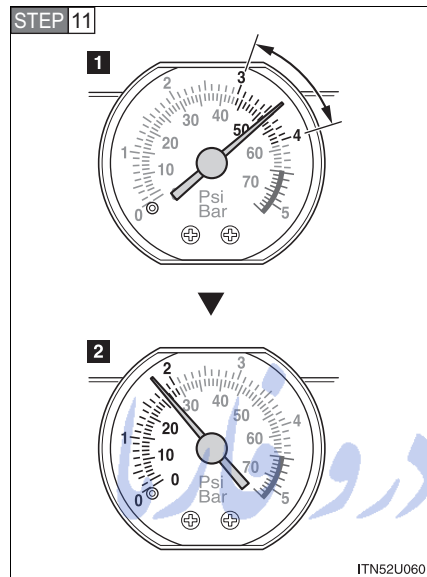

Inflate the tire until the recommended pressure is reached.

1 The sealant will be injected and the pressure will spike to 300 kPa (3.0 kgf/cm² or bar, 44 psi) or 400 kPa (4.0 kgf/cm² or bar, 58 psi), then gradually decrease.

2 The air pressure gauge will display the actual tire inflation pressure about 1 minute after the switch is turned on.

- Turn the compressor switch off and then check the tire inflation pressure. Being careful not to over inflate, check and repeat the inflation procedure until the recommended tire inflation pressure is reached.

تلفن: ۰۲۱-۸۸۶۲۰۸۵

FarmaSOS.com

5-2. Steps to take in an emergency

- If the needle of the air pressure gauge reaches the red zone (450 kPa [4.5 kgf/cm² or bar, 65 psi] or more), there may be a malfunction in the tire or in the kit itself. Stop operation immediately.
- If the tire inflation pressure is still lower than the recommended level after inflation for 10 minutes with the switch on, the tire is too damaged to be repaired. Turn the compressor switch off and contact any authorized Toyota dealer, tire dealer or repairer, or another duly qualified and equipped professional.
- If the tire inflation pressure exceeds the recommended level, let out some air to adjust the tire inflation pressure.

(→P. 783)

STEP 12 Disconnect the hose from the valve on the tire and then pull out the power plug from the power outlet socket.

STEP 13 To spread the liquid sealant evenly within the tire, immediately drive for about 5 km (3 miles).

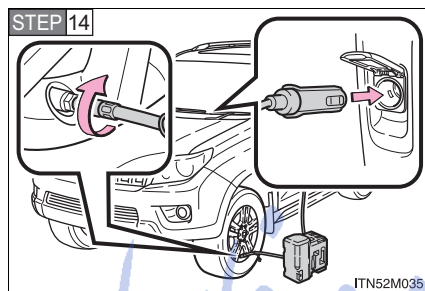

After driving for about 5 km (3 miles), stop your vehicle in a safe place on a hard, flat surface and reconnect the compressor.

تلفن شبانه روزی: ۰۲۱-۸۸۶۲۰۸۵

FarmaSOS.com

5-2. Steps to take in an emergency

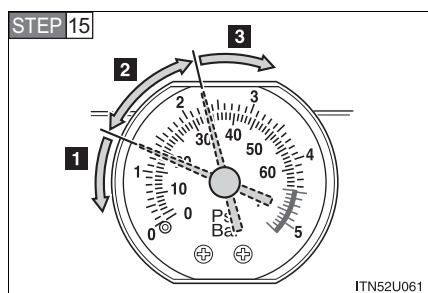

Turn the compressor switch on and wait for several seconds, then turn it off. Check the tire inflation pressure.

1 If the tire inflation pressure is below 130 kPa (1.3 kgf/cm² or bar, 19 psi): The puncture cannot be repaired. Contact any authorized Toyota dealer, tire dealer or repairer, or another duly qualified and equipped professional.

2 If the tire inflation pressure is between 130 kPa (1.3 kgf/cm² or bar, 19 psi) and a point below the recommended level: The tire can be repaired. Proceed to **STEP 16**.

3 If the tire inflation pressure is at the recommended level: Proceed to **STEP 17**.

STEP 16 Turn the compressor switch on to inflate the tire until the recommended tire inflation pressure is reached. Drive for about 5 km (3 miles) and then perform **STEP 14**.

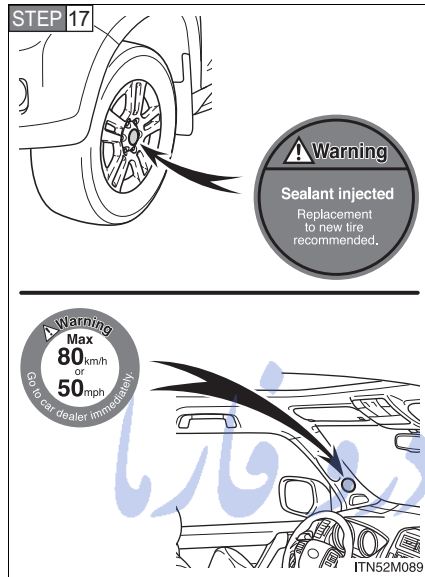

Store the kit and then attach the 2 stickers as shown.

Taking precautions to avoid sudden braking and sharp turns, drive carefully at under 80 km/h (50 mph) to the nearest authorized Toyota dealer, tire dealer or repairer, or another duly qualified and equipped professional for tire repair or replacement.

- **In the following cases, the tire cannot be repaired with the emergency tire puncture repair kit. Contact any authorized Toyota dealer, tire dealer or repairer, or another duly qualified and equipped professional.**
 - When the tire is damaged due to driving without sufficient air pressure
 - When the tire lost air pressure due to a crack or damage in the tire side-wall
 - When the tire is visibly separated from the wheel
 - When the cut or damage to the tread is 4 mm (0.16 in.) long or more
 - When the wheel is damaged
 - When two or more tires have been punctured
 - When there is more than one hole or cut in the damaged tire

5-2. Steps to take in an emergency

■ Emergency tire puncture repair kit

- The sealant has a limited lifespan. The expiry date is marked on the bottle. The sealant should be replaced before the expiry date. Contact any authorized Toyota dealer, tire dealer or repairer, or another duly qualified and equipped professional for replacement.
- The sealant stored in the emergency tire puncture repair kit can be used only once to temporarily repair a single tire. If the sealant in the bottle and other parts of the kit have been used and need to be replaced, contact any authorized Toyota dealer, tire dealer or repairer, or another duly qualified and equipped professional.
- The sealant can be used when the outside temperature is from -30 °C (-22 °F) to 60 °C (140 °F).
- The kit is exclusively designed for size and type of tires originally installed on your vehicle. Do not use it for tires that a different size than the original ones, or for any other purposes.
- If the sealant gets on your clothes, it may stain.
- If the sealant adheres to a wheel or the surface of the vehicle body, the stain may not be removable if it is not cleaned at once. Immediately wipe away the sealant with a wet cloth.
- During operation of the kit, a loud operation noise is produced. This does not indicate a malfunction.

FarmaSOS.com

■ **If the tire is inflated to more than the recommended level**

STEP 1 Disconnect the hose from the valve.

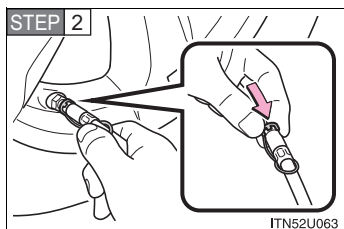

Install the air release cap to the end of the hose and push the protrusion on the air release cap into the valve to let some air out.

STEP 3 Disconnect the hose from the valve, remove the air release cap from the hose and then reconnect the hose.

STEP 4 Turn the compressor switch on and wait for several seconds, then turn it off. Check that the air pressure indicator shows the recommended level. (→P. 840)

If the air pressure is lower than the recommended level, turn the compressor switch on again and repeat the inflation procedure until the recommended pressure is reached.

CAUTION

■ **Precautions for use of the sealant**

- Ingesting the sealant is hazardous to your health. If you ingest sealant, consume as much water as possible, then immediately consult a doctor.
- If sealant gets in eyes or adheres to skin, immediately wash it off with water. If discomfort persists, consult a doctor.

 CAUTION

■ **When fixing the flat tire**

- Stop your vehicle in a safe and flat area.
- Connect the valve and hose securely with the tire installed on the vehicle.
- If the hose is not properly connected to the valve, air leakage may occur or sealant may be sprayed out.
- If the hose comes off the valve while inflating the tire, there is a risk that the hose will move abruptly due to air pressure.
- After inflation of the tire has completed, the sealant may splatter when the hose is disconnected or some air is let out of the tire.
- Keep back from the tire while it is being repaired, as there is a chance of it bursting while the repair operation is being performed. If you notice any cracks or deformation of the tire, turn off the compressor switch and stop the repair operation immediately.
- The kit may overheat if operated for a long period of time. Do not operate the compressor continuously for more than 20 minutes.
- Parts of the kit become hot during operation. Be careful handling the kit during and after operation.
- Do not attach the vehicle speed warning sticker to an area other than the one indicated. If the sticker is attached to an area where an SRS airbag is located, such as the pad of the steering wheel, it may prevent the SRS air bag from operating properly.

■ **Driving to spread the liquid sealant evenly**

- Drive the vehicle carefully at a low speed. Be especially careful when turning and cornering.
- If the vehicle does not drive straight or you feel a pull through the steering wheel, stop the vehicle and check the following:
 - Tire condition. The tire may have separated from the wheel.
 - Tire inflation pressure. If tire inflation pressure is 130 kPa (1.3 kgf/cm² or bar, 19 psi) or below, this may indicate severe tire damage.

 NOTICE**■ Do not drive the vehicle with a flat tire**

Do not continue driving with a flat tire.

Driving even a short distance with a flat tire can damage the tire and the wheel beyond repair.

■ When performing an emergency repair

- Perform the emergency repair without removing the nail or screw that has punctured the tread of the tire. If the object that has punctured the tire is removed, repair by the emergency tire puncture repair kit may not be possible.
- The kit is not waterproof. Make sure that the kit is not exposed to water, such as when it is being used in the rain.
- Do not put the kit directly onto dusty ground such as sand at the side of the road. If the kit vacuums up dust etc., a malfunction may occur.
- Use the kit with the top facing upward. The kit cannot work properly if it is laid on its side.

■ Handling the emergency tire puncture repair kit

- The compressor power source should be 12 V DC suitable for vehicle use. Do not connect the compressor to any other source.
- If gasoline splatters on the kit, the kit may deteriorate. Take care not to allow gasoline to contact it.
- Store the kit in its assigned place out of reach of children.
- Do not disassemble or modify the kit. Do not subject parts such as the air pressure indicator to impacts. This may cause a malfunction.

5-2. Steps to take in an emergency If the engine will not start

If the engine will not start even though correct starting procedures are being followed (→P. 239, P. 235), consider each of the following points:

■ **The engine will not start even when the starter motor operates normally.**

One of the following may be the cause of the problem:

- There may not be sufficient fuel in the vehicle's tank.
Gasoline engine: Refuel the vehicle.
Diesel engine: (→P. 806)
- The engine may be flooded. (gasoline engine)
Try to restart the engine again following correct starting procedures. (→P. 239)
- There may be a malfunction in the engine immobilizer system.
(→P. 152)

■ **The starter motor turns over slowly, the interior lights and headlights are dim, or the horn does not sound or sounds at a low volume.**

One of the following may be the cause of the problem:

- The battery may be discharged. (→P. 795)
- The battery terminal connections may be loose or corroded.

■ **The starter motor does not turn over (vehicles with a smart entry & start system).**

The engine starting system may be malfunctioning due to an electrical problem such as an open circuit or a blown fuse. However, an interim measure is available to start the engine.
(→P. 788)

■ **The starter motor does not turn over, the interior lights and headlights do not turn on, or the horn does not sound.**

One of the following may be the cause of the problem:

- One or both of the battery terminals may be disconnected.
- The battery may be discharged. (→P. 795)
- There may be a malfunction in the steering lock system.

Contact any authorized Toyota dealer or repairer, or another duly qualified and equipped professional, if the problem cannot be repaired, or if repair procedures are unknown.

تلفن شبانه روزی: ۰۲۱-۸۸۶۲۰۸۵

FarmaSOS.com

Emergency start function (vehicles with a smart entry & start system)

When the engine does not start, the following steps can be used as an interim measure to start the engine if the “ENGINE START STOP” switch is functioning normally.

STEP 1 Set the parking brake.

STEP 2 Put the shift lever in P (automatic transmission) or N (manual transmission).

STEP 3 Set the “ENGINE START STOP” switch to the ACCESSORY mode.

STEP 4 Push and hold the “ENGINE START STOP” switch for about 15 seconds while depressing the brake pedal (automatic transmission) or brake and clutch pedal (manual transmission) firmly.

Even if the engine can be started using the above steps, the system may be malfunctioning. Have the vehicle checked by any authorized Toyota dealer or repairer, or another duty qualified and equipped professional.

FarmaSOS.com

5-2. Steps to take in an emergency

If the shift lever cannot be shifted from P*

If the shift lever cannot be shifted with your foot on the brake pedal, there may be a problem with the shift lock system (a system to prevent accidental operation of the shift lever). Have the vehicle inspected by any authorized Toyota dealer or repairer, or another duly qualified and equipped professional, immediately.

The following steps may be used as an emergency measure to ensure that the shift lever can be shifted:

STEP 1 Set the parking brake.

STEP 2 Vehicles without a smart entry & start system: Turn the engine switch to the "ACC" position.

Vehicles with a smart entry & start system: Turn the "ENGINE START STOP" switch to ACCESSORY mode.

STEP 3 Depress the brake pedal.

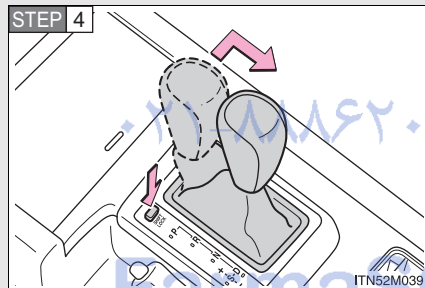

Press the shift lock override button.

The shift lever can be shifted while the button is pressed.

*: If equipped

5-2. Steps to take in an emergency

If you lose your keys/wireless remote control transmitter

■ Keys

New genuine keys can be made by any authorized Toyota dealer or repairer, or another duly qualified and equipped professional. For vehicles with the smart entry & start system, bring the other key and the key number stamped on the key number plate. For vehicles without the smart entry & start system, bring a master key and the key number stamped on the key number plate.

■ Wireless remote control transmitter (if equipped)

New genuine wireless remote control transmitter can be purchased and programmed by any authorized Toyota dealer or repairer, or another duly qualified and equipped professional. If a wireless remote control transmitter has been lost, bring the other wireless remote control transmitter when going to pick up the new transmitter.

تلفن شبانه روزی: ۰۲۱-۸۸۸۶۲۰۸۵

FarmaSOS.com

5-2. Steps to take in an emergency

If the electronic key does not operate properly*

For vehicles with a smart entry & start system: If communication between the electronic key and vehicle is interrupted (→P. 51) or the electronic key cannot be used because the battery is depleted, the smart entry & start system and wireless remote control cannot be used. In such cases, the doors can be opened or the engine can be started by following the procedure below.

Locking and unlocking the doors and key linked functions

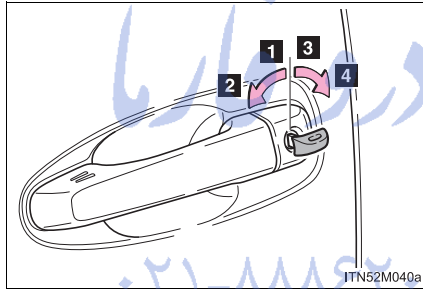

Use the mechanical key (→P. 36) in order to perform the following operations:

An alarm will sound if the alarm is set. (→P. 160)

- 1** Locks all doors
 - 2** Closes the windows/moon roof* (turn and hold)
 - 3** Unlocks all doors
 - 4** Opens the windows/moon roof* (turn and hold)
- *: If equipped

*: If equipped

Starting the engine

Automatic transmission

STEP 1 Ensure that the shift lever is in P and depress the brake pedal.

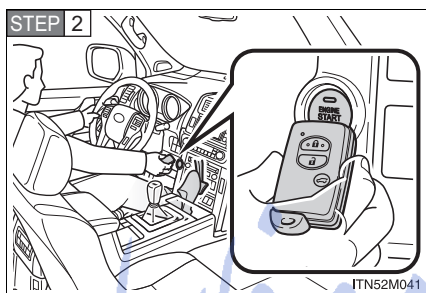

Touch the Toyota emblem side of the electronic key to the “ENGINE START STOP” switch.

If any of the doors is opened or closed while the key is being touched to the switch, an alarm will sound to indicate that the start function cannot detect the key.

STEP 3 Press the “ENGINE START STOP” switch within 10 seconds of the buzzer sounding, keeping the brake pedal depressed.

In the event that the “ENGINE START STOP” switch still cannot be operated, contact any authorized Toyota dealer or repairer, or another duly qualified and equipped professional.

تلفن شبانه روزی: ۰۲۱-۸۸۶۲۰۸۵

FarmaSOS.com

Manual transmission

STEP 1 Shift the shift lever to N and depress the clutch pedal.

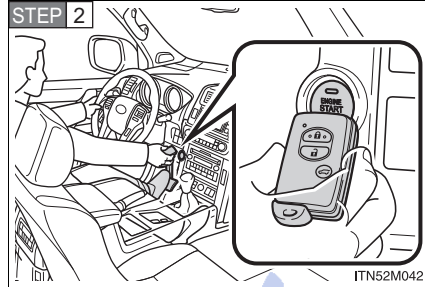

Touch the Toyota emblem side of the electronic key to the “ENGINE START STOP” switch.

If any of the doors is opened or closed while the key is being touched to the switch, an alarm will sound to indicate that the start function cannot detect the key.

STEP 3 Press the “ENGINE START STOP” switch within 10 seconds of the buzzer sounding, keeping the clutch pedal depressed.

In the event that the “ENGINE START STOP” switch still cannot be operated, contact any authorized Toyota dealer or repairer, or another duly qualified and equipped professional.

تلفن شبانه روزی: ۰۲۱-۸۸۶۲۰۸۵

FarmaSOS.com

■ **Stopping the engine**

Vehicles with an automatic transmission

Shift the shift lever to P and press the “ENGINE START STOP” switch as you normally do when stopping the engine.

Vehicles with a manual transmission

Shift the shift lever to N and press the “ENGINE START STOP” switch as you normally do when stopping the engine.

■ **Replacing the key battery**

As the above procedure is a temporary measure, it is recommended that the electronic key battery be replaced immediately when the battery is depleted. (→P. 658)

■ **Alarm**

Using the mechanical key to lock the doors will not set the alarm system. If a door is unlocked using the mechanical key when the alarm system is set, the alarm may be triggered. (→P. 160)

■ **Changing “ENGINE START STOP” switch modes**

Vehicles with an automatic transmission

Within 10 seconds of the buzzer sounding, release the brake pedal and press the “ENGINE START STOP” switch.

The engine does not start and modes will be changed each time the switch is pressed. (→P. 243)

Vehicles with a manual transmission

Within 10 seconds of the buzzer sounding, release the clutch pedal and press the “ENGINE START STOP” switch.

The engine does not start and modes will be changed each time the switch is pressed. (→P. 243)

5-2. Steps to take in an emergency If the vehicle battery is discharged

The following procedures may be used to start the engine if the vehicle's battery is discharged.

You can call any authorized Toyota dealer or repairer, or another duly qualified and equipped professional.

If you have a set of jumper (or booster) cables and a second vehicle with a 12-volt battery, you can jump start your Toyota following the steps below.

STEP 1 Open the hood. (→P. 622)

Remove the engine cover:

Vehicles with 1GR-FE engine

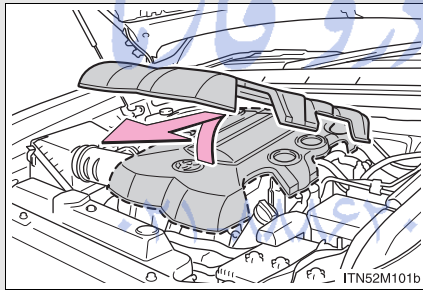

Lift the edge of the cover to fixed pins, and then pull the cover towards you to remove.

FarmaSOS.com

5

When trouble arises

5-2. Steps to take in an emergency

Vehicles with 1KD-FTV engine*1

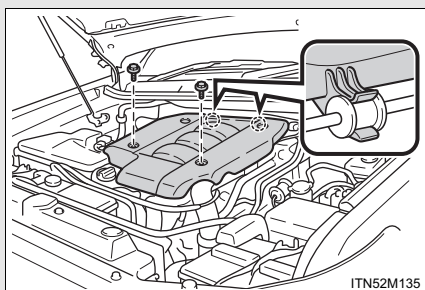

Remove the bolts.

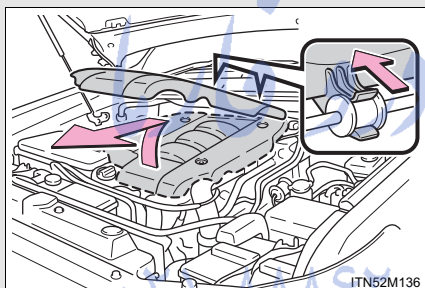

Raise the front of the engine cover and then pull the cover to detach it from the bracket on the rear bar as shown in the illustration.

STEP 2 Connect the jumper cables according to the following procedures:

FarmaSOS.com

2TR-FE engine

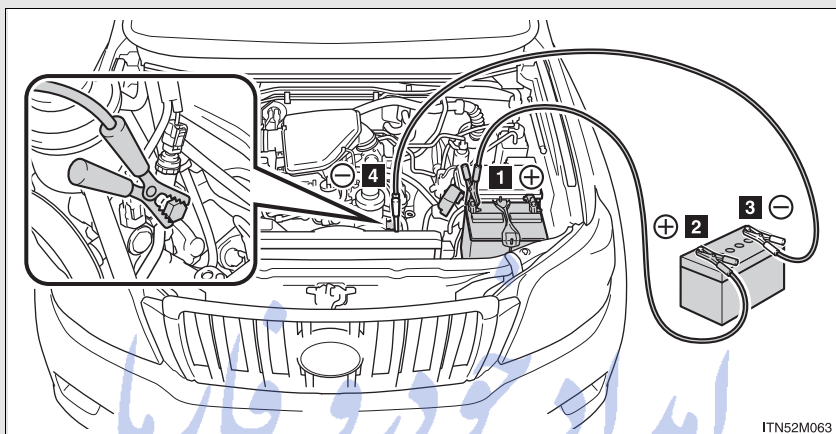

1GR-FE engine

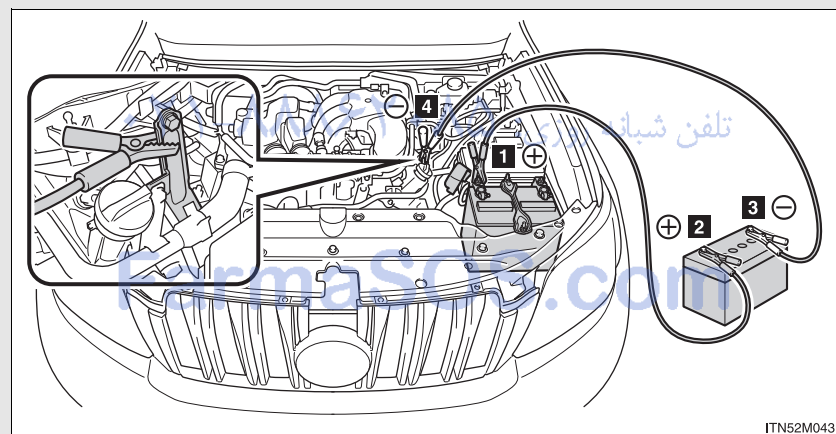

5-2. Steps to take in an emergency

1KD-FTV engine

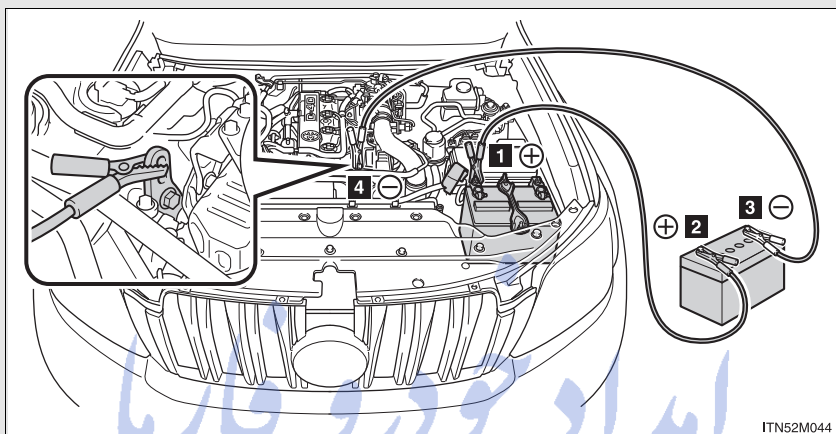

- 1** Positive (+) battery terminal on your vehicle
- 2** Positive (+) battery terminal on the second vehicle
- 3** Negative (-) battery terminal on the second vehicle
- 4** Connect the jumper cable to ground on your vehicle as shown in the illustration.

FarmaSOS.com

- STEP 3** Start the engine of the second vehicle. Increase the engine speed slightly and maintain at that level for approximately 5 minutes to recharge the battery of your vehicle.
- STEP 4** Vehicles with a smart entry & start system only: Open and close any of the doors of your vehicle with the “ENGINE START STOP” switch off.
- STEP 5** Maintain the engine speed of the second vehicle and start the engine of your vehicle by turning the “ENGINE START STOP” switch to IGNITION ON mode (vehicles with a smart entry & start system) or turning the engine switch to the “ON” position (vehicles without a smart entry & start system).
- STEP 6** Once the vehicle’s engine has started, remove the jumper cables in the exact reverse order in which they were connected.
- STEP 7** Vehicles with 1GR-FE engine and 1KD FTV engines*¹: To install the engine cover, conduct the removal procedure in reverse. After installing, check that the fixed pins are inserted securely.

Once the engine starts, have the vehicle checked at any authorized Toyota dealer or repairer, or another duly qualified and equipped professional, as soon as possible.

*¹: 1KD-FTV models (KDJ150R-GKFEYW, KDJ150R-GKAEYW, KDJ150L-GKFEYW, KDJ150L-GKAEYW, KDJ155R-GJFEYW, KDJ155R-GJAEYW, KDJ155L-GJFEYW and KDJ155L-GJAEYW models*² except for Russia, Ukraine, Serbia, Montenegro, Macedonia and Croatia)

*²: The model code is indicated on the manufacturer’s label. (→P. 815)

■ **Starting the engine when the battery is discharged (vehicles with an automatic transmission)**

The engine cannot be started by push-starting.

■ **To prevent battery discharge**

- Turn off the headlights and the audio system while the engine is off.
- Turn off any unnecessary electrical components when the vehicle is running at a low speed for an extended period, such as in heavy traffic.

■ **Charging the battery**

The electricity stored in the battery will discharge gradually even when the vehicle is not in use, due to natural discharge and the draining effects of certain electrical appliances. If the vehicle is left for a long time, the battery may discharge, and the engine may be unable to start. (The battery recharges automatically during driving.)

Make sure that the key is not inside the vehicle when recharging or replacing the battery. The key may be locked in the vehicle if the alarm is activated. (→P. 160)

 **CAUTION**

■ **Avoiding battery fires or explosions**

Observe the following precautions to prevent accidentally igniting the flammable gas that may be emitted from the battery:

- Make sure the jumper cable is connected to the correct terminal and that it is not unintentionally in contact with any other than the intended terminal.
- Do not allow the + and - clamps of the jumper cables to come into contact with each other.
- Do not smoke, use matches, cigarette lighters or allow open flame near the battery.

⚠ CAUTION**■ Battery precautions**

The battery contains poisonous and corrosive acidic electrolyte, while related parts contain lead and lead compounds. Observe the following precautions when handling the battery:

- When working with the battery, always wear safety glasses and take care not to allow any battery fluids (acid) to come into contact with skin, clothing or the vehicle body.
- Do not lean over the battery.
- In the event that battery fluid comes into contact with the skin or eyes, immediately wash the affected area with water and seek medical attention. Place a wet sponge or cloth over the affected area until medical attention can be received.
- Always wash your hands after handling the battery support, terminals, and other battery-related parts.
- Do not allow children near the battery.

■ To prevent damaging the vehicle (vehicles with a manual transmission)

Do not pull- or push-start the vehicle, because the catalytic converter may overheat and become a fire hazard.

FarmaSOS.com

 NOTICE

■ **When handling jumper cables**

When connecting the jumper cables, ensure that they do not become entangled in the cooling fans or belt.

■ **To prevent damage to the engine cover**

- When removing the cover, make sure that you pull the cover towards you after lifting the front edge to remove the fixed pins.
- When installing the cover, do not force the cover or subject it to strong shocks.

امداد خودرو فارما

تلفن شبانه روزی: ۰۲۱-۸۸۸۶۲۰۸۵

FarmaSOS.com

5-2. Steps to take in an emergency If your vehicle overheats

The following may indicate that your vehicle is overheating.

- The engine coolant temperature gauge enters the red zone or a loss of power is experienced.
- Steam is coming from under the hood.

Follow the correction procedure as described below.

STEP 1 Stop the vehicle in a safe place and turn off the air conditioning system, and then stop the engine.

STEP 2 If you see steam:

Carefully lift the hood after the steam subsides.

If you do not see steam:

Carefully lift the hood.

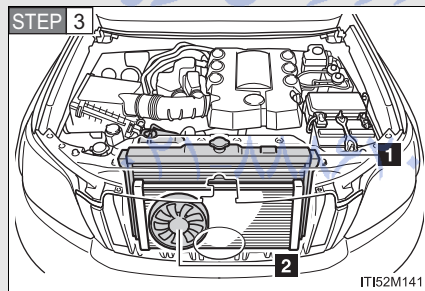

After the engine has cooled down sufficiently, inspect the hoses and radiator core (radiator) for any leaks.

- 1** Radiator
- 2** Cooling fan

If a large amount of coolant leaks, immediately contact any authorized Toyota dealer or repairer, or another duly qualified and equipped professional.

5

When trouble arises

5-2. Steps to take in an emergency

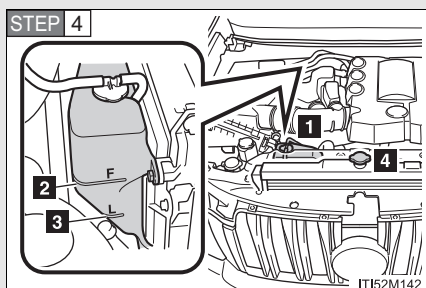

The coolant level is satisfactory if it is between the “FULL” or “F” and “LOW” or “L” lines on the reservoir. (→P. 632)

- 1** Reservoir
- 2** “FULL” or “F”
- 3** “LOW” or “L”
- 4** Radiator cap (if equipped)

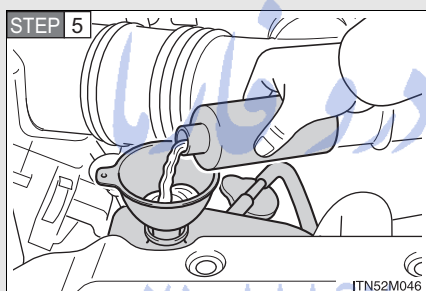

Add coolant if necessary. (→P. 626)

Water can be used in an emergency if coolant is unavailable.

STEP 6 Start the engine and turn the air conditioning system on to check that the radiator cooling fan operates and to check for coolant leaks from the radiator or hoses.

The fan operates when the air conditioning system is turned on immediately after a cold start. Confirm that the fan is operating by checking the fan sound and air flow. If it is difficult to check these, turn the air conditioning system on and off repeatedly. (The fan may not operate in freezing temperatures.)

STEP 7 If the fan is not operating:

Stop the engine immediately and contact any authorized Toyota dealer or repairer, or another duly qualified and equipped professional.

If the fan is operating:

Have the vehicle inspected at the nearest authorized Toyota dealer or repairer, or another duly qualified and equipped professional.

 CAUTION■ **To prevent an accident or injury when inspecting under the hood of your vehicle**

- If steam is seen coming from under the hood, do not open the hood until the steam has subsided. The engine compartment may be very hot, causing serious injury such as burns.
- Keep hands and clothing (especially a tie, a scarf or a muffler) away from the fan and others belts. Failure to do so may cause the hands or clothing to be caught, resulting in serious injury.
- Do not loosen the radiator cap, or the coolant reservoir cap while the engine and radiator are hot.
Serious injury, such as burns, may result from hot coolant and steam released under pressure.

 NOTICE■ **When adding engine coolant**

Wait until the engine has cooled down before adding engine coolant. When adding coolant, do so slowly. Adding cool coolant to a hot engine too quickly can cause damage to the engine.

■ **To prevent damage to the cooling system**

Observe the following precautions:

- Avoid contaminating the coolant with foreign matter (such as sand or dust etc.).
- Do not use commercially available coolant additives.

5-2. Steps to take in an emergency

If you run out of fuel and the engine stalls (diesel engine only)

If you run out of fuel and the engine stalls:

STEP 1 Refuel your vehicle.

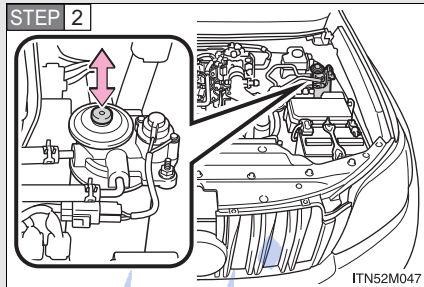

STEP 2

To bleed the fuel system, operate the priming pump until you feel more resistance.

STEP 3 Start the engine. (→P. 239)

If the engine does not start after the above steps have been performed, wait for 10 seconds and try step 2 and 3 again. If the engine still does not start, contact any authorized Toyota dealer or repair, or another duly qualified and equipped professional.

After starting the engine, depress the accelerator pedal lightly until the engine runs smoothly.

NOTICE

■ When restarting the engine

- Do not crank the engine before refueling and operating the priming pump. This may damage the engine and fuel system.
- Do not crank the engine for more than 30 seconds at a time. This may overheat the starter and wiring system.

5-2. Steps to take in an emergency If the vehicle becomes stuck

Carry out the following procedures if the tires spin or the vehicle becomes stuck in mud, dirt, or snow:

- STEP 1** Stop the engine. Set the parking brake and put the shift lever in P (automatic transmission) or N (manual transmission).
- STEP 2** Remove the mud, snow, or sand from around the stuck tire.
- STEP 3** Place wood, stones or some other material to help provide traction under the tires.
- STEP 4** Restart the engine.
- STEP 5** Shift the shift lever to the D or R position (automatic transmission) or 1 or R position (manual transmission), and carefully apply the accelerator to free the vehicle. Turn off TRC and VSC if these functions are hampering your attempts to free the vehicle. (→P. 375)

تلفن شبانه روزی: ۰۲۱-۸۸۶۲۰۸۵

FarmaSOS.com

5

When trouble arises

 CAUTION

■ **When attempting to free a stuck vehicle**

If you choose to push the vehicle back and forth to free it, make sure the surrounding area is clear, to avoid striking other vehicles, objects or people. The vehicle may also lunge forward or lunge back suddenly as it becomes free. Use extreme caution.

■ **When shifting the shift lever**

For vehicles with an automatic transmission, be careful not to shift the shift lever with the accelerator pedal depressed.

This may lead to unexpected rapid acceleration of the vehicle that may cause an accident and result in death or serious injury.

 NOTICE

■ **To avoid damaging the transmission and other components**

- Avoid spinning the wheels and depressing the accelerator pedal more than necessary.
- If the vehicle remains stuck even after these procedures are performed, the vehicle may require towing to be freed.

FarmaSOS.com

5-2. Steps to take in an emergency

If your vehicle has to be stopped in an emergency

Only in an emergency, such as if it becomes impossible to stop the vehicle in the normal way, stop the vehicle using the following procedure:

STEP 1 Steadily step on the brake pedal with both feet and firmly depress it.

Do not pump the brake pedal repeatedly as this will increase the effort required to slow the vehicle.

STEP 2 Shift the shift lever to N.

If the shift lever is shifted to N

STEP 3 After slowing down, stop the vehicle in a safe place by the road.

STEP 4 Stop the engine.

If the shift lever cannot be shifted to N

STEP 3 Keep depressing the brake pedal with both feet to reduce vehicle speed as much as possible.

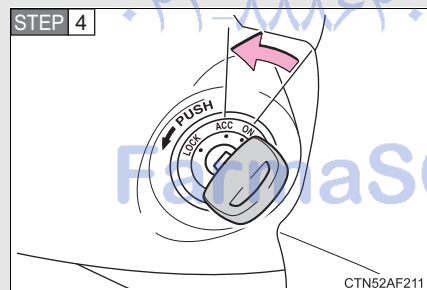

Vehicles without a smart entry & start system: Stop the engine by turning the engine switch to "ACC".

5-2. Steps to take in an emergency

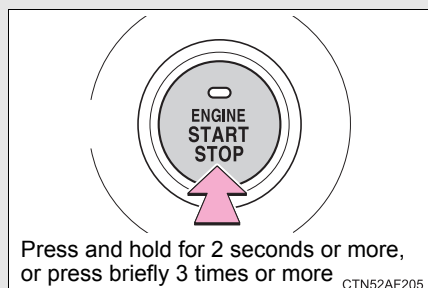

To stop the engine, press and hold the “ENGINE START STOP” switch for 2 consecutive seconds or more, or press it briefly 3 times or more in succession.

STEP 5 Stop the vehicle in a safe place by the road.

⚠ CAUTION

■ If the engine has to be turned off while driving

- Power assist for the brakes and steering wheel will be lost, making the brake pedal harder to depress and the steering wheel heavier to turn. Decelerate as much as possible before turning off the engine.
- Vehicles without a smart entry & start system: Never attempt to remove the key, as doing so will lock the steering wheel.

FarmaSOS.com

Vehicle specifications

6

6-1. Specifications

Maintenance data (fuel, oil level, etc.).....	812
Fuel information	844

6-2. Customization

Customizable features	849
-----------------------------	-----

6-3. Initialization

Items to initialize	862
---------------------------	-----

تلفن شبانه روزی: ۰۲۱-۸۸۸۶۲۰۸۵

FarmaSOS.com

6-1. Specifications

Maintenance data (fuel, oil level, etc.)

Dimensions and weights

Overall length	5-door models	4760 mm (187.4 in.) ^{*1,2} 4820 mm (189.8 in.) ^{*1,3} 4930 mm (194.1 in.) ^{*2,4}
	3-door models	4315 mm (169.9 in.) ^{*1} 4485 mm (176.6 in.) ^{*4}
Overall width		1885 mm (74.2 in.)
Overall height ^{*5}	5-door models	1835 mm (72.2 in.) ^{*6,8} 1845 mm (72.6 in.) ^{*7,8} 1880 mm (74.0 in.) ^{*6,9} 1890 mm (74.4 in.) ^{*7,9}
	3-door models	1835 mm (72.2 in.) ^{*8} 1880 mm (74.0 in.) ^{*9}
Wheelbase	5-door models	2790 mm (109.8 in.)
	3-door models	2455 mm (96.7 in.)
Tread	Front	1585 mm (62.4 in.) ^{*10} 1605 mm (63.2 in.) ^{*11}
	Rear	1585 mm (62.4 in.) ^{*10} 1605 mm (63.2 in.) ^{*11}

FarmaSOS.com

Gross vehicle mass	5-door models	1GR-FE engine	7-seat models 2900 kg (6393 lb.) 5-seat models 2900 kg (6393 lb.) 2-seat models 2830 kg (6239 lb.)
		2TR-FE engine	2850 kg (6283 lb.)
		1KD-FTV engine	Vehicle category M1* ¹³ 2990 kg (6592 lb.) Vehicle category N1* ¹³ 5-seat models 2980 kg (6571 lb.) 2-seat models 2890 kg (6371 lb.)
	3-door models	2600 kg (5732 lb.)	
Maximum permissible axle capacity	Front	1450 kg (3197 lb.)	
	Rear	1800 kg (3968 lb.)	
Drawbar load		120 kg (265 lb.)* ¹⁴ 60 kg (132 lb.)* ¹⁵	
Towing capacity	With brake	3000 kg (6614 lb.)* ¹⁴ 1500 kg (3307 lb.)* ¹⁵	
	Without brake	750 kg (1653 lb.)	

6-1. Specifications

- *1: Vehicles without back door mounted spare tire
- *2: Vehicles without bumper guard
- *3: Vehicles with bumper guard
- *4: Vehicles with back door mounted spare tire
- *5: Unladen vehicles
- *6: Vehicles with rear height control air suspension
- *7: Vehicles without rear height control air suspension
- *8: Vehicles without roof rail
- *9: Vehicles with roof rail
- *10: P265/65R17, 265/65R17, P265/60R18 or 265/60R18 tires
- *11: P245/70R17 or 245/70R17 tires
- *12: The model code is indicated on the manufacturer's label. (→P. 815)
- *13: To distinguish the vehicle category, ask any authorized Toyota dealer or repairer, or another duly qualified and equipped professional.
- *14: GRJ150L-GKAEKW, KDJ150R-GKFEYW, KDJ150R-GKAEYW, KDJ150L-GKFEYW, KDJ150L-GKAEYW, KDJ155R-GJFEYW, KDJ155R-GJAEYW, KDJ155L-GJFEYW and KDJ155L-GJAEYW models*12
- *15: TRJ150L-GKMEK, TRJ150L-GKPEK, GRJ150L-GKAEK, KDJ150L-GKFEY and KDJ150L-GKAEY models*12

FarmaSOS.com

Vehicle identification

■ Vehicle identification number

The vehicle identification number (VIN) is the legal identifier for your vehicle. This is the primary identification number for your Toyota. It is used in registering the ownership of your vehicle.

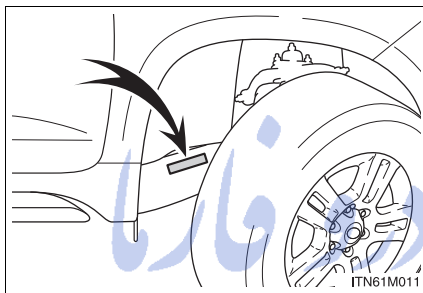

This number is stamped on the front right frame.

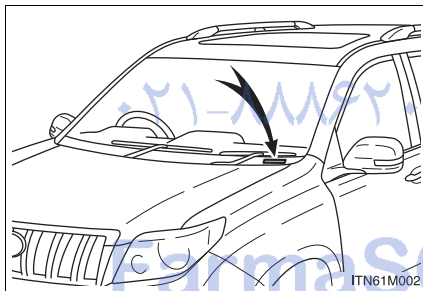

On some models, this number is also stamped on the top left of the instrument panel.

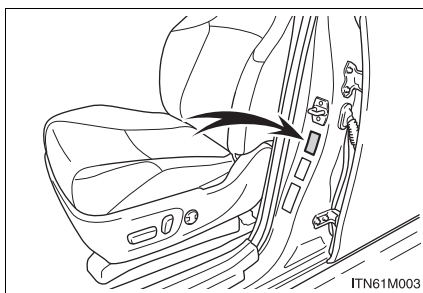

This number is also on the manufacturer's label on the left-hand side center pillar.

6-1. Specifications

■ Engine number

The engine number is stamped on the engine block as shown.

1GR-FE engine

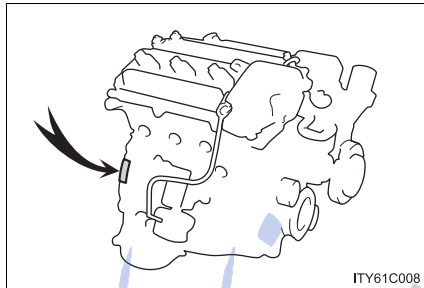

2TR-FE engine

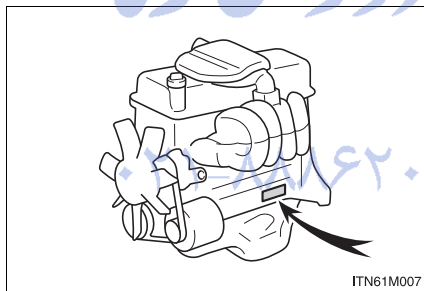

1KD-FTV engine

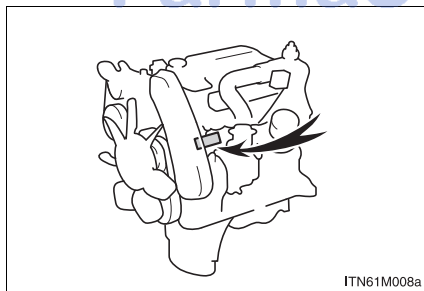

Engine**Gasoline engine**

Model	1GR-FE	2TR-FE
Type	6-cylinder V type, 4-cycle, gasoline	4-cylinder in line, 4-cycle, gasoline
Bore and stroke	94.0 × 95.0 mm (3.70 × 3.74 in.)	95.0 × 95.0 mm (3.74 × 3.74 in.)
Displacement	3956 cm ³ (241.4 cu.in.)	2694 cm ³ (164.4 cu.in.)
Valve clearance (engine cold)	Automatic adjustment	
Drive belt tension	Automatic adjustment	

Diesel engine

Model	1KD-FTV
Type	4-cylinder in line, 4-cycle, diesel (with turbocharger)
Bore and stroke	96.0 × 103.0 mm (3.78 × 4.06 in.)
Displacement	2982 cm ³ (182.0 cu.in.)
Valve clearance (engine cold)	Intake: 0.20 — 0.30 mm (0.008 — 0.012 in.) Exhaust: 0.35 — 0.45 mm (0.014 — 0.018 in.)
Drive belt tension	Automatic adjustment

6-1. Specifications

Fuel

Gasoline engine

Fuel type		Unleaded gasoline only
Research octane number		1GR-FE engine 95 or higher 2TR-FE engine 91 or higher
Fuel tank capacity (Reference)	Vehicles with sub fuel tank system	150 L (39.6 gal., 33.0 Imp.gal.)
	Vehicles without sub fuel tank system	87 L (23.0 gal., 19.1 Imp.gal.)

Diesel engine

Fuel type		Diesel fuel only
Cetane number		48 or higher
Fuel tank capacity (Reference)	Vehicles with sub fuel tank system	150 L (39.6 gal., 33.0 Imp.gal.)
	Vehicles without sub fuel tank system	87 L (23.0 gal., 19.1 Imp.gal.)

Lubrication system**1GR-FE engine**

Oil capacity (Drain and refill — reference)	
With filter	6.1 L (6.4 qt., 5.4 Imp.qt.)
Without filter	5.7 L (6.0 qt., 5.0 Imp.qt.)

■ **Engine oil selection (GRJ150L-GKAEKW models*)**

“Toyota Genuine Motor Oil” is used in your Toyota vehicle. Toyota recommends the use of approved “Toyota Genuine Motor Oil”. Another motor oil of matching quality can also be used.

Oil grade:

0W-20, 5W-20, 5W-30 and 10W-30:

API grade SL “Energy-Conserving”, SM “Energy-Conserving”, SN “Resource-Conserving” or ILSAC multigrade engine oil

15W-40 and 20W-50:

API grade SL, SM or SN multigrade engine oil

FarmaSOS.com

Recommended viscosity (SAE):

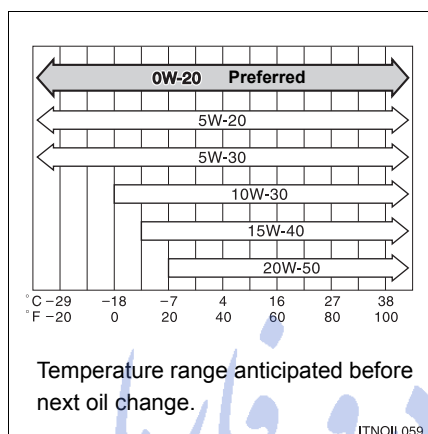

SAE 0W-20 is filled into your Toyota vehicle at manufacturing, and the best choice for good fuel economy and good starting in cold weather.

If SAE 0W-20 oil is not available, SAE 5W-30 oil may be used. However, it should be replaced with SAE 0W-20 at the next oil change.

If you use SAE 10W-30 or a higher viscosity engine oil in extremely low temperatures, the engine may become difficult to start, so SAE 5W-30 or lower viscosity engine oil is recommended.

The 0W portion of the oil viscosity rating indicates the characteristic of the oil which allows cold startability. Oils with a lower value before the W allow for easier starting of the engine in cold weather.

The 20 in 0W-20 indicates the oil viscosity when the oil is at its operating temperature. An oil with a higher viscosity may be better suited if the vehicle is operated at high speeds, or under extreme load conditions.

How to read oil container labels:

Either or both API registered marks are added to some oil containers to help you select the oil you should use.

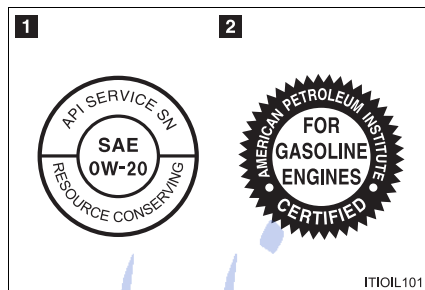

1 API Service Symbol

Top portion: The oil quality designation by API (American Petroleum Institute) (SN)

Center portion: The SAE viscosity grade (SAE 0W-20)

Lower portion: "Resource-Conserving" means that the oil has fuel saving and environmental protection capabilities.

2 ILSAC Certification Mark

The ILSAC (International Lubricant Standardization and Approval Committee) Certification Mark is displayed on the front of the container.

FarmaSOS.com

■ **Engine oil selection (GRJ150L-GKAEK models*)**

“Toyota Genuine Motor Oil” is used in your Toyota vehicle. Use Toyota approved “Toyota Genuine Motor Oil” or equivalent to satisfy the following grade and viscosity.

Oil grade:

5W-30 and 10W-30:

API grade SL “Energy-Conserving”, SM “Energy-Conserving”, SN “Resource-Conserving” or ILSAC multigrade engine oil

15W-40 and 20W-50:

API grade SL, SM or SN multigrade engine oil

Recommended viscosity (SAE):

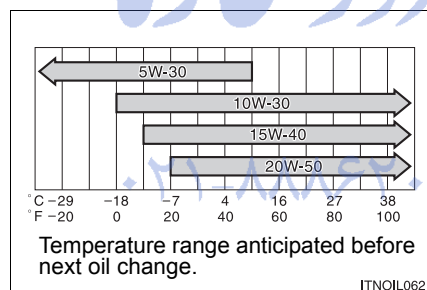

If you use SAE 10W-30 or a higher viscosity engine oil in extremely low temperatures, the engine may become difficult to start, so SAE 5W-30 engine oil is recommended.

The 10W portion of the oil viscosity rating indicates the characteristic of the oil which allows cold startability. Oils with a lower value before the W allow for easier starting of the engine in cold weather.

The 30 in 10W-30 indicates the oil viscosity when the oil is at its operating temperature. An oil with a higher viscosity may be better suited if the vehicle is operated at high speeds, or under extreme load conditions.

How to read oil container labels:

Either or both API registered marks are added to some oil containers to help you select the oil you should use.

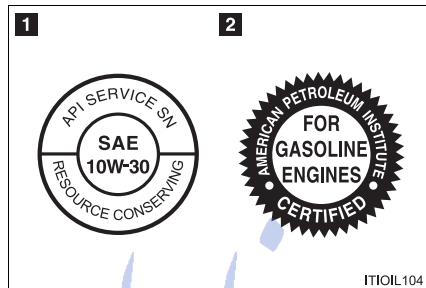

1 API Service Symbol

Top portion: The oil quality designation by API (American Petroleum Institute) (SN)

Center portion: The SAE viscosity grade (SAE 10W-30)

Lower portion: "Resource-Conserving" means that the oil has fuel saving and environmental protection capabilities.

2 ILSAC Certification Mark

The ILSAC (International Lubricant Standardization and Approval Committee) Certification Mark is displayed on the front of the container.

FarmaSOS.com

2TR-FE engine

Oil capacity (Drain and refill — reference)	
With filter	5.7 L (6.0 qt., 5.0 Imp.qt.)
Without filter	5.0 L (5.3 qt., 4.4 Imp.qt.)

■ Engine oil selection

“Toyota Genuine Motor Oil” is used in your Toyota vehicle. Use Toyota approved “Toyota Genuine Motor Oil” or equivalent to satisfy the following grade and viscosity.

Oil grade:

0W-20, 5W-20, 5W-30 and 10W-30:

API grade SL “Energy-Conserving”, SM “Energy-Conserving”, SN “Resource-Conserving” or ILSAC multigrade engine oil

15W-40 and 20W-50:

API grade SL, SM or SN multigrade engine oil

FarmaSOS.com

Recommended viscosity (SAE):

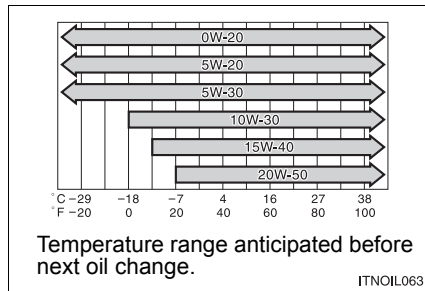

If you use SAE 10W-30 or a higher viscosity engine oil in extremely low temperatures, the engine may become difficult to start, so SAE 5W-30 or lower viscosity engine oil is recommended.

The 0W portion of the oil viscosity rating indicates the characteristic of the oil which allows cold startability. Oils with a lower value before the W allow for easier starting of the engine in cold weather.

The 20 in 0W-20 indicates the oil viscosity when the oil is at its operating temperature. An oil with a higher viscosity may be better suited if the vehicle is operated at high speeds, or under extreme load conditions.

تلفن شبانه روزی: ۰۲۱-۸۸۶۲۰۸۵

FarmaSOS.com

6-1. Specifications

How to read oil container labels:

Either or both API registered marks are added to some oil containers to help you select the oil you should use.

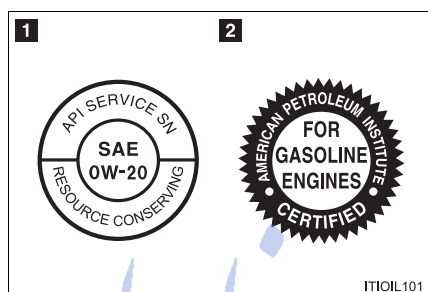

1 API Service Symbol

Top portion: The oil quality designation by API (American Petroleum Institute) (SN)

Center portion: The SAE viscosity grade (SAE 0W-20)

Lower portion: "Resource-Conserving" means that the oil has fuel saving and environmental protection capabilities.

2 ILSAC Certification Mark

The ILSAC (International Lubricant Standardization and Approval Committee) Certification Mark is displayed on the front of the container.

FarmaSOS.com

1KD-FTV engine

Oil capacity (Drain and refill — reference)	
With filter	7.0 L (7.4 qt., 6.2 Imp.qt.)
Without filter	6.7 L (7.1 qt., 5.9 Imp.qt.)

- **Engine oil selection (KDJ150R-GKFEYW, KDJ150R-GKAEYW, KDJ150L-GKFEYW, KDJ150L-GKAEYW, KDJ155R-GJFEYW, KDJ155R-GJAEYW, KDJ155L-GJFEYW and KDJ155L-GJAEYW models* except for Russia, Ukraine, Serbia, Montenegro, Macedonia and Croatia)**

“Toyota Genuine Motor Oil” is used in your Toyota vehicle. Toyota recommends the use of approved “Toyota Genuine Motor Oil”. Another motor oil of matching quality can also be used.

Oil grade: ACEA C2

 NOTICE تلفن شبانه روزی: ۰۸۵+۸۸۶۲-۱
Using engine oil other than ACEA C2 may damage the catalytic converter.

FarmaSOS.com

6-1. Specifications

Recommended viscosity (SAE):

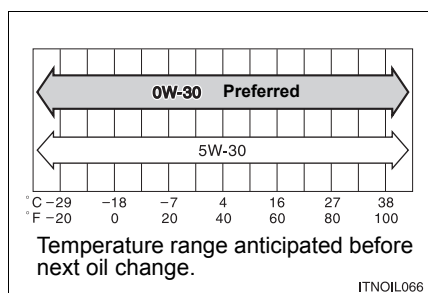

SAE 0W-30 is filled into your Toyota vehicle at manufacturing, and the best choice for good fuel economy and good starting in cold weather.

The 0W portion of the oil viscosity rating indicates the characteristic of the oil which allows cold startability. Oils with a lower value before the W allow for easier starting of the engine in cold weather.

The 30 in 0W-30 indicates the oil viscosity when the oil is at its operating temperature. An oil with a higher viscosity may be better suited if the vehicle is operated at high speeds, or under extreme load conditions.

تلفن شبانه روزی: ۰۲۱-۸۸۶۲۰۸۵

FarmaSOS.com

■ **Engine oil selection (Vehicles for Russia, Ukraine, Serbia, Montenegro, Macedonia and Croatia or KDJ150L-GKFEY and KDJ150L-GKAEY models*)**

“Toyota Genuine Motor Oil” is used in your Toyota vehicle. Use Toyota approved “Toyota Genuine Motor Oil” or equivalent to satisfy the following grade and viscosity.

Oil grade: G-DLD-1, API CF-4, CF or ACEA B1

Recommended viscosity (SAE):

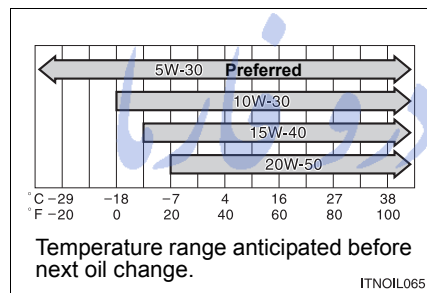

SAE 5W-30 is the best choice for good fuel economy and good starting in cold weather.

If you use SAE 10W-30 or a higher viscosity engine oil in extremely low temperatures, the engine may become difficult to start, so SAE 5W-30 engine oil is recommended.

The 5W portion of the oil viscosity rating indicates the characteristic of the oil which allows cold startability. Oils with a lower value before the W allow for easier starting of the engine in cold weather.

The 30 in 5W-30 indicates the oil viscosity when the oil is at its operating temperature. An oil with a higher viscosity may be better suited if the vehicle is operated at high speeds, or under extreme load conditions.

6-1. Specifications

DLD logo mark:



The Global DLD-1 logo mark, attached on some oil containers to help in selecting the oil you should use, indicates that the oil meets the guidelines recommended by the following associations:

- ACEA (Association des Constructeurs Europeens d'Automobiles)
- AAM (Alliance of Automobile Manufacturers)
- EMA (Engine Manufacturers Association)
- JAMA (Japan Automobile Manufacturers Association)

*: The model code is indicated on the manufacturer's label. (→P. 815)

FarmaSOS.com

Cooling system

Capacity (Refer- ence)	1GR-FE engine	With ATF warmer	With rear heater 12.8 L (13.5 qt., 11.3 Imp.qt.) Without rear heater 11.0 L (11.6 qt., 9.7 Imp.qt.)
		Without ATF warmer	With rear heater 12.3 L (13.0 qt., 10.8 Imp.qt.) Without rear heater 10.5 L (11.1 qt., 9.2 Imp.qt.)
	2TR-FE engine	With automatic transmission	With rear heater 9.9 L (10.5 qt., 8.7 Imp.qt.) Without rear heater 8.1 L (8.6 qt., 7.1 Imp.qt.)
		With manual transmission	With rear heater 10.1 L (10.7 qt., 8.9 Imp.qt.) Without rear heater 8.3 L (8.8 qt., 7.3 Imp.qt.)
	1KD-FTV engine	With automatic transmission	With rear heater 14.9 L (15.7 qt., 13.1 Imp.qt.) Without rear heater 13.1 L (13.8 qt., 11.5 Imp.qt.)
		With manual transmission	With rear heater 15.0 L (15.9 qt., 13.2 Imp.qt.) Without rear heater 13.2 L (13.9 qt., 11.6 Imp.qt.)

6-1. Specifications

Coolant type	Use either of the following. <ul style="list-style-type: none">• “Toyota Super Long Life Coolant”• A similar high-quality ethylene glycol-based non-silicate, non-amine, non-nitrite, and non-borate coolant with long-life hybrid organic acid technology Do not use plain water alone.
--------------	---

امداد خودرو فارما

تلفن شبانه روزی: ۰۲۱-۸۸۸۶۲۰۸۵

FarmaSOS.com

Ignition system (gasoline engine only)

Spark plug	
Make	DENSO SK20HR11
Gap	1.1 mm (0.043 in.)

⚠ NOTICE**■ Iridium-tipped spark plugs**

Use only iridium-tipped spark plugs. Do not adjust the spark plug gap.

Electrical system

Battery	
Specific gravity reading at 20 °C (68 °F):	1.250 — 1.290 Fully charged 1.160 — 1.200 Half charged 1.060 — 1.100 Discharged
Charging rates	
Quick charge	15 A max.
Slow charge	5 A max.

6-1. Specifications

Front differential

Oil capacity	1.40 L (1.48 qt., 1.23 Imp.qt.)
Oil type and viscosity*	Toyota Genuine Differential Gear Oil LT 75W-85 GL-5 or equivalent

*: Your Toyota vehicle is filled with “Toyota Genuine Differential Gear Oil” at the factory.

Use Toyota approved “Toyota Genuine Differential Gear Oil” or an equivalent of matching quality to satisfy the above specification. Please contact any authorized Toyota dealer or repairer, or another duly qualified and equipped professional for further details.

Rear differential

Oil capacity	5-door models	With rear differential lock system	2.65 L (2.80 qt., 2.33 Imp.qt.)
		Without rear differential lock system	2.70 L (2.85 qt., 2.38 Imp.qt.)
	3-door models		2.20 L (2.32 qt., 1.94 Imp.qt.)
Oil type and viscosity*		Toyota Genuine Differential Gear Oil LT 75W-85 GL-5 or equivalent	

*: Your Toyota vehicle is filled with “Toyota Genuine Differential Gear Oil” at the factory.

Use Toyota approved “Toyota Genuine Differential Gear Oil” or an equivalent of matching quality to satisfy the above specification. Please contact any authorized Toyota dealer or repairer, or another duly qualified and equipped professional for further details.

Automatic transmission

Fluid capacity*	1GR-FE engine	10.9 L (11.5 qt., 9.6 Imp.qt.)
	2TR-FE engine	9.9 L (10.5 qt., 8.7 Imp.qt.)
	1KD-FTV engine	10.6 L (11.2 qt., 9.3 Imp.qt.)
Fluid type	Toyota Genuine ATF WS	

*: The fluid capacity is a reference quantity.
If replacement is necessary, contact any authorized Toyota dealer or repairer, or another duly qualified and equipped professional.

⚠ NOTICE**■ Transmission fluid type**

Using transmission fluid other than "Toyota Genuine ATF WS" may cause deterioration in shift quality, locking up of the transmission accompanied by vibration and, ultimately, damage to the vehicle's transmission.

تلفن شبانه روزی: ۰۲۱-۸۸۶۲۰۸۵

FarmaSOS.com

6-1. Specifications

Manual transmission

5-speed models

Gear oil capacity	2.2 L (2.3 qt., 1.9 Imp.qt.)
Gear oil type	Gear oil API GL-4 or GL-5
Recommended gear oil viscosity	SAE 75W-90

6-speed models

Gear oil capacity	2.1 L (2.2 qt., 1.8 Imp.qt.)
Gear oil type	Toyota Genuine Transfer Gear oil LF or equivalent
Recommended gear oil viscosity	SAE 75W

NOTICE

■ Manual transmission gear oil (6-speed models)

Using a manual transmission gear oil other than "TOYOTA Genuine Transfer Gear oil LF SAE 75W" may cause occurrences of gear noise or other types of deterioration.

Clutch

Clutch pedal free play	5 — 15 mm (0.2 — 0.6 in.)
Fluid type	SAE J1703 or FMVSS No.116 DOT 3

Transfer

Oil capacity	1.4 L (1.5 qt., 1.2 Imp.qt.)
Oil type*	Toyota Genuine Transfer Gear oil LF or equivalent
Recommended oil viscosity	SAE 75W

*: Your Toyota vehicle is filled with “Toyota Genuine Transfer Gear oil LF” at the factory. Use Toyota approved “Toyota Genuine Transfer Gear oil LF” or an equivalent of matching quality to satisfy the above specification. Please contact any authorized Toyota dealer or repairer, or another duly qualified and equipped professional for further details.

تلفن شبانه روزی: ۰۲۱-۸۸۶۲۰۸۵
FarmaSOS.com

6-1. Specifications

Brakes

Pedal clearance* ¹	1GR-FE and 1KD-FTV engines	Left-hand drive	With automatic transmission 101 mm (4.0 in.) Min. With manual transmission 94 mm (3.7 in.) Min.
		Right-hand drive	101 mm (4.0 in.) Min.
	2TR-FE engine		With automatic transmission 105 mm (4.1 in.) Min. With manual transmission 102 mm (4.0 in.) Min.
Pedal free play		1 — 6 mm (0.04 — 0.24 in.)	
Parking brake lever travel* ²		5 — 7 clicks	
Fluid type		SAE J1703 or FMVSS No. 116 DOT 3	

*1: Minimum pedal clearance when depressed with a force of 490 N (50 kgf, 110 lbf) while the engine is running

*2: Parking brake lever travel when pulled up with a force of 200 N (20.4 kgf, 45.0 lbf)

FarmaSOS.com

Chassis lubrication

Propeller shafts	Spider	Lithium base chassis grease, NLGI No.2
	Slide yoke	Molybdenum-disulfide lithium base chassis grease, NLGI No.2 or lithium base chassis grease, NLGI No.2

Steering

Free play	Less than 30 mm (1.18 in.)
Power steering fluid type	Automatic transmission fluid DEXRON® II or III

تلفن شبانه روزی: ۰۲۱-۸۸۶۲۰۸۵

FarmaSOS.com

6-1. Specifications

Tires and wheels

17-inch tires (type A)

Tire size	P245/70R17 108S, 245/70R17 110S	
Tire inflation pressure (Recommended cold tire inflation pressure)	Front wheel kPa (kgf/cm ² or bar, psi)	Rear wheel kPa (kgf/cm ² or bar, psi)
	220 (2.2, 32)	220 (2.2, 32)
Wheel size	17 × 6 1/2J	
Wheel nut torque	112 N•m (11.4 kgf•m, 83 ft•lbf)	

17-inch tires (type B)

Tire size	245/70R17 110S	
Tire inflation pressure (Recommended cold tire inflation pressure)	Front wheel kPa (kgf/cm ² or bar, psi)	Rear wheel kPa (kgf/cm ² or bar, psi)
	200 (2.0, 29)	200 (2.0, 29) 220 (2.2, 32)*
Wheel size	17 × 6 1/2J	
Wheel nut torque	112 N•m (11.4 kgf•m, 83 ft•lbf)	

*: Standard inflation for all loads including full rated loads

17-inch tires (type C)

Tire size	P265/65R17 110S, 265/65R17 112S	
Tire inflation pressure (Recommended cold tire inflation pressure)	Front wheel kPa (kgf/cm ² or bar, psi)	Rear wheel kPa (kgf/cm ² or bar, psi)
	220 (2.2, 32)	220 (2.2, 32)
Wheel size	17 × 7 1/2J	
Wheel nut torque	112 N•m (11.4 kgf•m, 83 ft•lbf)	

17-inch tires (type D)

Tire size	265/65R17 112S	
Tire inflation pressure (Recommended cold tire inflation pressure)	Front wheel kPa (kgf/cm ² or bar, psi)	Rear wheel kPa (kgf/cm ² or bar, psi)
	200 (2.0, 29)	200 (2.0, 29)
Wheel size	17 × 7 1/2J	
Wheel nut torque	112 N•m (11.4 kgf•m, 83 ft•lbf)	

تلفن شبانه روزی: ۰۲۱-۸۸۶۲۰۸۵

FarmaSOS.com

6-1. Specifications

18-inch tires (type A)

Tire size	P265/60R18 109H, 265/60R18 110H	
Tire inflation pressure (Recommended cold tire inflation pressure)	Front wheel kPa (kgf/cm ² or bar, psi)	Rear wheel kPa (kgf/cm ² or bar, psi)
	220 (2.2, 32)	220 (2.2, 32)
Wheel size	18 × 7 1/2J	
Wheel nut torque	112 N•m (11.4 kgf•m, 83 ft•lbf)	

18-inch tires (type B)

Tire size	265/60R18 110H	
Tire inflation pressure (Recommended cold tire inflation pressure)	Front wheel kPa (kgf/cm ² or bar, psi)	Rear wheel kPa (kgf/cm ² or bar, psi)
	200 (2.0, 29)	200 (2.0, 29) 220 (2.2, 32)*
Wheel size	18 × 7 1/2J	
Wheel nut torque	112 N•m (11.4 kgf•m, 83 ft•lbf)	

*: Standard inflation for all loads including full rated loads

FarmaSOS.com

Light bulbs

	Light bulbs	W	Type
Exterior	Headlights		
	Low beam (discharge bulbs*)	35	A
	Low beam (halogen bulbs*)	55	B
	High beam	60	C
	Front turn signal lights	21	D
	Front position lights	5	E
	Front fog lights*	55	B
	Rear turn signal lights	21	D
	Back-up lights	16	E
	Rear fog lights*	21	E
License plate lights	5	E	
Running board lights*	5	E	
Interior	Personal/interior lights		
	Front	5	E
	Rear (without personal lights)*	8	F
	Rear (with personal lights)*	5	E
	Vanity lights	8	E
Door courtesy lights	5	E	

A: D4S discharge bulbs

B: H11 halogen bulbs

C: HB3 halogen bulbs

D: Wedge base bulbs (amber)

E: Wedge base bulbs (clear)

F: Double end bulbs

*: If equipped

6-1. Specifications

Fuel information

1GR-FE engine	<p>EU area: Your vehicle must use only unleaded gasoline conforming to European standard EN228. For optimum engine performance, select unleaded gasoline with a Research Octane Number of 95 or higher. If this premium type cannot be obtained, you can temporarily use unleaded gasoline with a Research Octane Number as low as 91.</p> <p>Except EU area: Your vehicle must use only unleaded gasoline. For optimum engine performance, select unleaded gasoline with a Research Octane Number of 95 or higher. If this premium type cannot be obtained, you can temporarily use unleaded gasoline with a Research Octane Number as low as 91.</p>
---------------	--

2TR-FE engine	<p>EU area: Your vehicle must use only unleaded gasoline conforming to European standard EN228. For optimum engine performance, select unleaded gasoline with a Research Octane Number of 91 or higher.</p> <p>Except EU area: Your vehicle must use only unleaded gasoline. For optimum engine performance, select unleaded gasoline with a Research Octane Number of 91 or higher.</p>
---------------	--

تلفن شبانه روزی: ۰۲۱-۸۸۸۶۲۰۸۵

FarmaSOS.com

6-1. Specifications

1KD-FTV engine	<p>Your vehicle must use only diesel fuel conforming to European standard EN590.</p> <p>Without DPF catalytic converter*¹ Your vehicle must use only diesel fuel that contains 350 ppm or less of sulfur and has a cetane number of 48 or higher.</p> <p>With DPF catalytic converter*² Your vehicle must use only diesel fuel that contains 50 ppm or less of sulfur and has a cetane number of 48 or higher.</p>
----------------	--

*¹: Vehicles for Russia, Ukraine, Serbia, Montenegro, Macedonia and Croatia or KDJ150L-GKFEY and KDJ150L-GKAEY models*³

*²: KDJ150R-GKFEYW, KDJ150R-GKAEYW, KDJ150L-GKFEYW, KDJ150L-GKAEYW, KDJ155R-GJFEYW, KDJ155R-GJAEYW, KDJ155L-GJFEYW and KDJ155L-GJAEYW models*³ except for Russia, Ukraine, Serbia, Montenegro, Macedonia and Croatia

*³: The model code is indicated on the manufacturer's label. (→P. 815)

FarmaSOS.com

■ Fuel tank opening for unleaded gasoline

To help prevent incorrect fueling, your vehicle has a fuel tank opening that only accommodates the special nozzle on unleaded fuel pumps.

■ If you plan to drive in foreign countries

Low sulphur diesel fuel may not be available, so please check the availability with your distributor.

■ If your engine knocks

- Consult any authorized Toyota dealer or repairer, or another duly qualified and equipped professional.
- You may occasionally notice light knocking for a short time while accelerating or driving uphill. This is normal and there is no need for concern.

NOTICE

■ Notice on fuel quality

- Do not use improper fuels. If improper fuels are used, the engine will be damaged.
- Gasoline engine: Do not use leaded gasoline.
Leaded gasoline will cause the three-way catalytic converter to lose its effectiveness and the emission control system to function improperly.
- Gasoline engine (EU area): Bioethanol fuel sold under names such as "E50" or "E85" and fuel containing a large amount of ethanol should not be used. The use of these fuels will damage the vehicle's fuel system. In case of any doubt, ask any authorized Toyota dealer or repairer, or another duly qualified and equipped professional.

 NOTICE

- Gasoline engine (except EU area): Bioethanol fuel sold under names such as “E50” or “E85” and fuel containing a large amount of ethanol should not be used. Your vehicle can use gasoline mixed with 10 % max ethanol. The use of fuel with more than 10 % ethanol content (E10) will damage the vehicle’s fuel system. You must ensure that refueling is carried out only from a source where fuel specification and quality can be guaranteed. In case of any doubt, ask any authorized Toyota dealer or repairer, or another duly qualified and equipped professional.
 - 1KD-FTV engine: FAME (Fatty Acid Methyl Ester) fuel sold under names such as “B30” or “B100” and fuel containing a large amount of FAME should not be used. Your vehicle can use diesel mixed with 5 % max bio-diesel FAME (B5). The use of fuel with more than 5 % FAME content (B5) will damage the vehicle’s fuel system. You must ensure that refueling is carried out only from a source where fuel specification and quality can be guaranteed. In case of any doubt, ask any authorized Toyota dealer or repairer, or another duly qualified and equipped professional.
 - 1KD-FTV engine (without DPF catalytic converter*¹):
Do not use a fuel that contains more than 350 ppm of sulfur.
Use of such a high sulfur fuel may damage the engine.
 - 1KD-FTV engine (with DPF catalytic converter*²):
Do not use a fuel that contains more than 50 ppm of sulfur.
Use of such a high sulfur fuel may damage the engine.
- *¹: Vehicles for Russia, Ukraine, Serbia, Montenegro, Macedonia and Croatia or KDJ150L-GKFEY and KDJ150L-GKAEY models*³
- *²: KDJ150R-GKFEYW, KDJ150R-GKAEYW, KDJ150L-GKFEYW, KDJ150L-GKAEYW, KDJ155R-GJFEYW, KDJ155R-GJAEYW, KDJ155L-GJFEYW and KDJ155L-GJAEYW models*³ except for Russia, Ukraine, Serbia, Montenegro, Macedonia and Croatia
- *³: The model code is indicated on the manufacturer’s label. (→P. 815)

6-2. Customization

Customizable features

Your vehicle includes a variety of electronic features that can be personalized to suit your preferences. Programming of these preferences can be performed by any authorized Toyota dealer or repairer, or another duly qualified and equipped professional.

It is also possible to customize certain vehicle features yourself using the menu switch and the “ENTER” switch.

Some function settings are changed simultaneously with other functions being customized. Contact any authorized Toyota dealer or repairer, or another duly qualified and equipped professional for further details.

Customizing vehicle features

It is possible to customize certain vehicle features using the menu switch and the “ENTER” switch.

When customizing vehicle features, ensure that the vehicle is parked in a safe place with the shift lever in P (automatic transmission) or N (manual transmission) and the parking brake set.

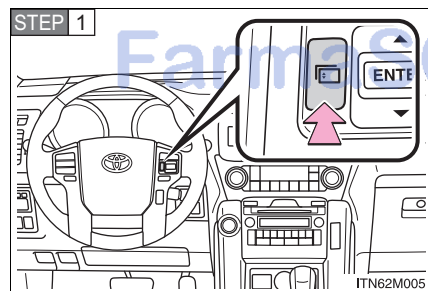

Press and hold the menu switch to display customization mode.

6-2. Customization

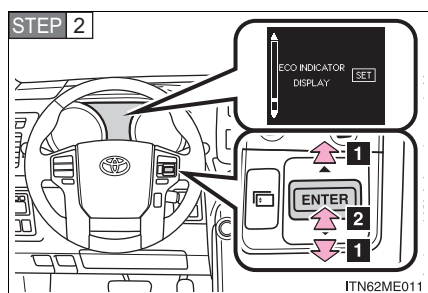

- 1 Press the “ENTER” switch upwards or downwards to select the item to be customized.
- 2 Press the “ENTER” switch to confirm.

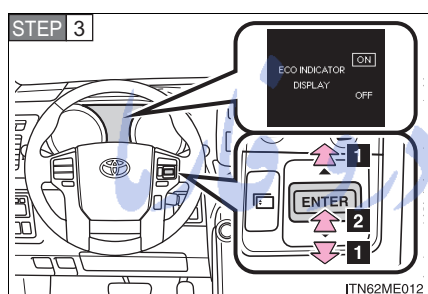

- 1 Press the “ENTER” switch upwards or downwards to select the desired setting for the item being customized.
- 2 Press the “ENTER” switch to confirm.

When customization is completed, press the menu switch to clear the customization screen.

Customizable features

- 1 Settings that can be changed using the menu switch and the “ENTER” switch
- 2 Settings that can be changed by any authorized Toyota dealer or repairer, or another duly qualified and equipped professional

Definition of symbols: O = Available, – =Not available

Item	Function	Default setting	Customized setting	1	2
Door lock (→P. 74, 791)	Unlocking using a key	All doors unlocked in one step	Driver's door unlocked in one step, all doors unlocked in two steps	–	○
	Speed-detecting automatic door lock function*1, 2	On	Off	○	○
	Shifting gears to position other than P locks all doors*1	Off	On	○	○
	Shifting gears to P unlocks all doors*1	Off	On	○	○
	Opening driver's door unlocks all doors*1, 2	Off	On	○	○

6-2. Customization

Item	Function	Default setting	Customized setting	1	2
Smart entry & start system and wireless remote control (→P. 39, 66)	Operation signal (buzzer) ^{*3}	7	Off	○	○
			1 to 6		
	Operation signal (Emergency flashers)	On	Off	○	○
	Time elapsed before the automatic door lock function is activated if a door is not opened after being unlocked	30 seconds	60 seconds	-	○
			120 seconds		
	Open door warning function (When locking the vehicle) ^{*3}	On	Off	-	○
Glass hatch opening operation ^{*3}	Push and hold (Short)	Push twice	-	○	
		One short push			
		Push and hold (Long)			
		Off			

Item	Function	Default setting	Customized setting	1	2
Smart entry & start system (→P. 39)	Smart door unlocking* ⁴	All the doors	Driver's door	○	○
	Smart entry & start system* ⁴	On	Off	○	○
Wireless remote control (→P. 66)	Unlocking operation	All doors unlocked in one step	Driver's door unlocked in one step, all doors unlocked in two steps	○	○
Automatic light control system (→P. 300)	Time elapsed before the headlights turn off* ³	30 seconds	Off	○	○
			60 seconds		
			90 seconds		
	Light sensor sensitivity* ³	Standard	-2 to 2	○	○
Time elapsed before headlights automatically turn on* ³	Standard	Long	-	○* ⁷	

6-2. Customization

Item	Function	Default setting	Customized setting	1	2
Illumination (→P. 557)	Time elapsed before the interior lights turn off	15 seconds	Off	○	○
			7.5 seconds		
			30 seconds		
	Time elapsed before the exterior lights turn off	15 seconds	Off	○	○
			7.5 seconds		
			30 seconds		
	Sensitivity of the ambient light sensor used for dimming the meter lights etc.*3	Standard	-2 to 2	-	○
Sensitivity of the ambient light sensor used for brightening the meter lights etc.*3	Standard	-2 to 2	-	○	

Item	Function	Default setting	Customized setting	1	2
Illumination (→P. 557)	Operation after the engine switch is turned to the "LOCK" position (without a smart entry & start system) or the "ENGINE START STOP" switch is turned to OFF (with a smart entry & start system)	On	Off	-	0
	Operation when the doors are unlocked with the smart entry & start system or wireless remote control	On	Off	-	0

6-2. Customization

Item	Function	Default setting	Customized setting	1	2
Illumination (→P. 557)	Operation when you approach the vehicle with the electronic key on your person*4	On	Off	-	0
	Footwell lighting	On	Off	-	0

امداد خودرو فارما

تلفن شبانه روزی: ۰۲۱-۸۸۸۶۲۰۸۵

FarmaSOS.com

Item	Function	Default setting	Customized setting	1	2
Running board lights (→P. 557)	Running board lights*3	On	Off	–	O
	Operation when you approach the vehicle with the electronic key on your person*3	On	Off	–	O
	Operation when the doors are unlocked with the smart entry & start system or wireless remote control*3	On	Off	–	O
	Operation when the doors are unlocked with the power door lock switch*3	On	Off	–	O
	Operation when the door is opened*3	On	Off	–	O

6-2. Customization

Item	Function	Default setting	Customized setting	1	2
Front automatic air conditioning system	Switching between outside air and recirculated air mode linked to automatic mode button operation*3	Auto	Manual	-	O
	A/C automatic mode button operation*3	Auto	Manual	-	O
Seat belt reminder buzzer (→P. 709)	Speed-linked seat belt reminder function*3	On	Off	-	O
Eco Driving Indicator Light (→P. 276, 282, 292)	Activating Eco Driving Indicator Light*5	On	Off	O	-

FarmaSOS.com

Item	Function	Default setting	Customized setting	1	2
Power windows (→P. 137)	Door key linked operation	Off	On	–	○
	Wireless remote control linked operation	Off	On	–	○
Moon roof (→P. 141)	Door key linked operation*3	Off	On	–	○
	Wireless remote control linked operation*3, 6	Off	On	–	○
Toyota parking assist-sensor (→P. 345)	Buzzer volume*3	3	1 to 5	–	○

*1: GRJ150L-GKAEKW, KDJ150R-GKAEYW, KDJ150L-GKAEYW, KDJ155R-GJAEYW and KDJ155L-GJAEYW models*8

*2: KDJ150R-GKFEYW, KDJ150L-GKFEYW, KDJ155R-GJFEYW and KDJ155L-GJFEYW models*8

*3: If equipped.

*4: Vehicles with a smart entry & start system only.

*5: For vehicles with non-optitron type multi-information display, the setting can be changed by operating the multi-information display. (→P. 276)

*6: This function cannot be customized unless power window operation using the wireless remote control is enabled.

*7: TRJ150L-GKMEK, TRJ150L-GKPEK, GRJ150L-GKAEK, KDJ150L-GKFEY and KDJ150L-GKAEY models (The model code is indicated on the manufacturer's label)

*8: The model code is indicated on the manufacturer's label. (→P. 815)

Multi-information display (→P. 276, 282, 292)

Settings that can be changed using the menu switch and the “ENTER” switch.

Available units	
Type A	km & l (km/l), km & l (l/100 km), miles & Imp.gal. and miles & U.S. gal.
Type B	km & l (l/100 km) and miles & Imp.gal.

Available languages (accessory meters and optitron type meters)	
Type A	English (UK), French, German, Spanish, Italian, Taiwanese and Russian
Type B	English (UK), English (U.S.A.), French, Spanish and Chinese

■ **In the following situations, customize mode will automatically be turned off.**

- A warning message appears after the customize mode screen is displayed.
- The engine switch is turned to the “LOCK” position (without a smart entry & start system) or the “ENGINE START STOP” switch is turned to OFF (with a smart entry & start system).
- The vehicle begins to move while the customize mode screen is displayed.

⚠ CAUTION**■ Cautions during customization**

As the engine needs to be running during customization, ensure that the vehicle is parked in a place with adequate ventilation. In a closed area such as a garage, exhaust gases including harmful carbon monoxide (CO) may collect and enter the vehicle. This may lead to death or a serious health hazard.

⚠ NOTICE**■ During customization**

To prevent battery discharge, ensure that the engine is running while customizing features.

تلفن شبانه روزی: ۰۲۱-۸۸۶۲۰۸۵

FarmaSOS.com

6-3. Initialization

Items to initialize

The following items must be initialized for normal system operation in cases such as after the battery is reconnected, or maintenance is performed on the vehicle.

Item	When to initialize	Reference
Engine oil maintenance data*	After changing engine oil	P. 630

*: If equipped

امداد خودرو فارما

تلفن شبانه روزی: ۰۲۱-۸۸۸۶۲۰۸۵

FarmaSOS.com

Index

Abbreviation list 864

Alphabetical index..... 865

What to do if... 875

For vehicles with a navigation system, refer to the “Navigation System Owner’s Manual” for information regarding the equipment listed below.

- Navigation system
- Air conditioning
- Hands-free system (for cellular phone)
- Toyota parking assist monitor
- Rear view monitor system
- Rear seat entertainment system
- Audio/video system
- Toyota parking assist-sensor
- Wide view front & side monitor

For details of information about off-road driving techniques and off-road assistance functions, refer to the “Off-road Driving Owner’s Manual”.

Abbreviation list**Abbreviation/Acronym list**

ABBREVIATIONS	MEANING
ABS	Anti-lock Brake System
ACC	Accessory
AFS	Adaptive Front-lighting System
AI-SHIFT	Artificial Intelligence Shift control
ALR	Automatic Locking Retractor
AVS	Adaptive Variable Suspension System
CRS	Child Restraint System
DAC	Downhill Assist Control
DISP	Display
DPF	Diesel Particulate Filter
ELR	Emergency Locking Retractor
GVM	Gross Vehicle Mass
KDSS	Kinetic Dynamic Suspension System
LED	Light Emitting Diode
PCS	Pre-Crash Safety
SRS	Supplemental Restraint System
TRC	Traction Control
VIN	Vehicle Identification Number
VSC	Vehicle Stability Control

Alphabetical index

Alphabetical index

A	A/C 418, 425	Alarm 160
	ABS 373	Antenna 457
	Active head restraint 94, 96	Anti-lock brake system 373
	Active traction control *1 373	Armrest 593
	Adaptive Front-lighting	Assist grips 595
	System 307	Ashtray 584
	Adaptive Variable	Audio system
	Suspension System *1	Antenna 457
	AFS 307	Audio input..... 499
	Air conditioning filter 654	AUX adapter 499
	Airbags	CD player/changer..... 458
	Airbag manual on-off	iPod..... 477
	system 213	MP3/WMA disc 468
	Airbag operating	Optimal use..... 496
	conditions 174	Portable music player 499
	Airbag precautions for	Radio 453
	your child 179	Steering wheel audio
	Airbag warning light 705	switch 501
	General airbag precautions... 179	Type..... 449
	Locations of airbags..... 170	USB memory 486
	Modification and disposal of	Automatic air conditioning
	airbags..... 184	system
	Proper driving posture... 168, 179	Air conditioning filter 654
	Side and curtain	Front automatic
	shield airbags operating	air conditioning system..... 425
	conditions 174	Rear automatic
	Side and curtain shield	air conditioning system..... 438
	airbags precautions 179	Automatic headlight leveling
	SRS airbags..... 170	system 311
	Air conditioning system	Automatic light control
	Air conditioning filter..... 654	system 300
	Front automatic	Automatic transmission
	air conditioning system 425	Automatic transmission..... 249
	Front manual	If the shift lever cannot be
	air conditioning system 418	shifted from P 789
	Rear automatic	S mode 254
	air conditioning system 438	AUX adapter 499
	Rear manual	Auxiliary box 573, 600
	air conditioning system 435	Auxiliary tray 601
		AVS *1

*1: Refer to the "Off-road Driving Owner's Manual".

B	<p>Back door</p> <ul style="list-style-type: none"> Back door 81 Back door child-protector lock 83 Wireless remote control 66 <p>Back-up lights</p> <ul style="list-style-type: none"> Replacing light bulbs 675 Wattage 843 <p>Battery</p> <ul style="list-style-type: none"> Checking 636 If the vehicle has discharged battery 795 Preparing and checking before winter 396 <p>Bluetooth®</p> <ul style="list-style-type: none"> Audio 504 Mobile phone 523 <p>Bottle holders/ door pockets 567</p> <p>Brake</p> <ul style="list-style-type: none"> Fluid 838 Parking brake 264 <p>Brake assist 373</p> <p>Brightness control</p> <ul style="list-style-type: none"> Instrument panel light control 268 Lounge illumination control 560 	<p>Child restraint system</p> <ul style="list-style-type: none"> Baby seats, definition 185 Baby seats, installation 197 Child seats, definition 185 Child seats, installation 197 Installing CRS with ISOFIX rigid anchor 204 Installing CRS with seat belts 199 Installing CRS with top straps 206 Junior seats, definition 185 Junior seats, installation 197 <p>Child safety</p> <ul style="list-style-type: none"> Airbag precautions 179 Back door precautions 636, 801 Battery precautions 636, 801 Child restraint system 185 Child-protectors 76, 83 Glass hatch precaution 84 How your child should wear the seat belt 126 Installing child restraints 197 Moon roof precautions 145 Power window lock switch 137 Power window precautions ... 140 Removed key battery precautions 660 Seat belt precautions 127 Seat heater precautions 592 <p>Child-protectors 76, 83</p> <p>Cleaning</p> <ul style="list-style-type: none"> Exterior 606 Interior 610 Seat belts 611 <p>Clock 581</p> <p>Coat hooks 594</p> <p>Condenser 635</p>
C	<p>Care</p> <ul style="list-style-type: none"> Exterior 606 Interior 610 Seat belts 611 <p>Card holder 564</p> <p>Cargo capacity 392</p> <p>Cargo hooks 598</p> <p>CD changer 458</p> <p>CD player 458</p> <p>Center differential lock *1</p> <p>Chains 396</p>	

Console box 565

Cool box 576

Cooling system

 Engine overheating 803

Crawl Control*1

Cruise control

 Cruise control 324

 Dynamic radar

 cruise control 328

Cup holder 569

Curtain shield airbags 170

Customizable features 849

D

DAC*1

Daytime running light system 308

Deck rail 598

Defogger

 Rear window 444

 Side mirrors 444

Dimension 812

Display

 Dynamic radar cruise control 328

 Multi-information display 276, 282, 292

 Trip information 276, 282, 292

 Toyota parking assist-sensor 345

 Warning message 718

Do-it-yourself maintenance 617

Door courtesy lights

 Door courtesy lights 557

 Wattage 843

Doors

 Back door 81

 Back door child-protector lock 83

 Door glasses 137

 Door lock 39, 66, 74

 Double locking system 158

 Rear door child-protector lock 76

 Side doors 74

 Side mirrors 134

Double locking system 158

Downhill Assist Control System*1

DPF

 Diesel Particulate Filter system 389

 Warning light 703

 Warning message 718

Driver's seat belt reminder light 709

Driving

 Correct posture 168

 Off-road precautions*1

 Procedures 218

 Winter driving tips 396

Driving position memory 115

Dynamic radar cruise control 328

E

Electronic key

 If the electronic key does not operate properly 791

Emergency brake signal 374

Emergency, in case of

 If the electronic key does not operate properly 791

 If the engine will not start 786

 If the shift lever cannot be shifted from P 789

 If the vehicle has discharged battery 795

 If the warning buzzer sounds 703

*1: Refer to the "Off-road Driving Owner's Manual".

If the warning light turns on ... 703	
If the warning message is displayed 718	
If you have a flat tire 743, 765	
If you lose your keys 790	
If you think something is wrong..... 701	
If you run out of fuel and the engine stalls..... 806	
If your vehicle becomes stuck 807	
If your vehicle has to be stopped in an emergency 809	
If your vehicle needs to be towed 694	
If your vehicle overheats 803	
Emergency flashers	
Switch 692	
Engine	
Compartment 623	
Engine switch..... 235, 239	
Hood 622	
How to start the engine..... 235, 239	
Identification number..... 815	
If the engine will not start 786	
If you run out of fuel and the engine stalls..... 806	
Ignition switch 235, 239	
Overheating 803	
Engine compartment cover 626	
Engine coolant	
Capacity 831	
Checking 632	
Preparing and checking before winter..... 396	
Engine coolant temperature gauge..... 266	
Engine immobilizer system 152	
	Engine oil
	Capacity 819
	Checking..... 627
	Preparing and checking before winter..... 396
	Engine switch 235, 239
	Engine switch light..... 557
	F
	Floor mat 596
	Fluid
	Brake 838
	Power steering..... 839
	Washer 641
	Fog lights
	Replacing light bulbs..... 679, 686
	Switch 312
	Wattage 843
	Foot well lights 557
	Four-wheel drive system*1
	Front fog lights
	Replacing light bulbs..... 679
	Switch 312
	Wattage 843
	Front passenger's seat belt reminder light 709
	Front position lights
	Replacing light bulbs..... 681
	Switch 300
	Wattage 843
	Front seats
	Adjustment..... 93
	Driving position memory 115
	Front turn signal lights
	Replacing light bulbs..... 682
	Switch 263
	Wattage 843
	Fuel
	Capacity..... 818
	Fuel gauge..... 266
	Fuel pump shut off system.... 702

Gas station information	880	I	Identification	
If you run out of fuel and the engine stalls.....	806		Engine.....	815
Information	844		Vehicle	815
Refueling.....	146		Ignition switch	235, 239
Type	844		Ignition switch light.....	557
Fuel door	146		Illuminated entry system	561
Fuel filler door.....	146		Inside door handle light	557
Fuel pump shut off system	702		Indicator lights	270
Fuses	661		Inside rear view mirror	132
			Instrument panel light	
G			control	268
Gas station information	880		Intercooler.....	635
Gauges.....	266		Intrusion sensor	162
Glass hatch	88			
Glove box	563	J	Jack	
Glove box light.....	563		Vehicle-equipped jack... 743, 765	
			Jack handle	743, 765
H				
Hands-free system		K	KDSS*1	374
(for mobile phone).....	523		Keyless entry	66
Head restraints			Keys	
Adjusting	119		Electronic key	34
Headlight cleaner.....	322		Engine switch.....	235, 239
Headlights			If you lose your keys	790
Adaptive front lighting			If your electronic key does	
system	307		not operate properly	791
Discharge headlights			Key number	34
precautions	690		Keyless entry	66
Replacing light bulbs.....	677, 678		Keys.....	34
Switch	300		Mechanical key	36
Wattage.....	843		Wireless remote control key ...	66
Heaters			Kinetic dynamic suspension	
Seat heaters.....	590		system*1	374
Side mirror	444		Knee airbags	170
Hill-start assist control*1	374			
Hood.....	622			
Hooks				
Cargo	598			
Cargo net	600			
Coat	594			

*1: Refer to the "Off-road Driving Owner's Manual".

L	License plate lights		
	Replacing light bulbs.....	687	
	Wattage.....	843	
	Light bulbs		
	Replacing.....	675	
	Wattage.....	843	
	Lights		
	Door courtesy lights.....	557	
	Engine switch light.....	557	
	Fog light switch.....	312	
	Headlights switch.....	300	
	Inside door handle lights.....	557	
	Interior light list.....	557	
	Personal/interior light switch.....	559	
	Replacing light bulbs.....	675	
	Running board lights.....	557	
	Shift lever light.....	557	
	Turn signal lever.....	263	
	Vanity lights.....	580	
	Wattage.....	843	
	Luggage cover.....	602	
M	Maintenance		
	Do-it-yourself maintenance...617		
	Maintenance data.....	812	
	Maintenance requirements...613		
	Manual headlight leveling		
	dial.....	301	
	Manual transmission.....	258	
	Meter		
	Instrument panel light control.....	268	
	Meters.....	266	
	Mirrors		
	Conversation mirror.....	585	
	Inside rear view mirror.....	132	
	Side mirror heater.....	444	
	Side mirrors.....	134	
	Vanity mirrors.....	580	
	Moon roof.....	141	
	MP3 disc.....	468	
	Multi-information		
	display.....	276, 282, 292	
	Multi-terrain ABS*1		
	Multi-terrain Monitor*1		
	Multi-terrain Select*1		
O	Odometer.....	266	
	Off road precautions*1		
	Oil		
	Engine oil.....	627	
	Opener		
	Back door.....	81	
	Fuel filler door.....	146	
	Hood.....	622	
	Outside rear view mirrors		
	Adjusting and folding.....	134	
	Driving position memory.....	115	
	Outside temperature		
	display.....	582	
	Overhead console.....	573	
	Overheating, Engine.....	803	
P	Parking brake.....	264	
	PCS.....	380	
	Personal/interior lights		
	Personal/interior lights.....	557	
	Switch.....	559	
	Wattage.....	843	
	Pollen removal mode.....	433	
	Power heater.....	443	
	Power outlet.....	586	
	Power steering		
	Fluid.....	839	
	Power windows.....	137	
	Pre-Crash Safety system.....	380	

R	Radiator 635 Radio 453 RDS 455 Rear air conditioning system Automatic air conditioning system 438 Manual air conditioning system 435 Rear fog lights Replacing light bulbs 686 Switch 313 Wattage 843 Rear view monitor system 356 Rear differential lock system *1 Rear height control air suspension *1 Rear seat Adjustment 97 Folding down the second seatbacks 102, 103 Folding down the third seats 106, 109 Tumbling seats 100 Rear seat entertainment system *2 Rear step bumper 83 Rear turn signal lights Replacing light bulbs 684 Wattage 843 Rear window defogger 444 Rear window wiper 320 Replacing Key battery 656 Fuses 661 Light bulbs 675 Tires 743 Roof luggage carrier 392	S	Seat belts Adjusting the seat belt 123 Automatic Locking Retractor 125 Child restraint system installation 197 Cleaning and maintaining the seat belts 611 Emergency Locking Retractor 125 How to wear your seat belt ... 122 How your child should wear the seat belt 126 Pre-crash seat belts 124 Pregnant women, proper seat belt use 125 Reminder light 709 Seat belt pretensioners 124 Seat heaters 590 Seats Adjustment 115 Adjustment precautions 96 Child seats/child restraint system installation 197 Cleaning 610 Driver's seat position memory 115 Front seat adjustment 93 Head restraint 119 Properly sitting in the seat ... 168 Rear seat adjustment 97 Seat heaters 590 Service reminder indicators 270
----------	---	----------	---

*1: Refer to the "Off-road Driving Owner's Manual".

*2: Refer to the "Navigation System Owner's Manual".

Shift lever	
Automatic transmission.....	249
If the shift lever cannot be shifted from "P"	789
Manual transmission	258
Shift lever light.....	557
Shift lock system	789
Side airbags	170
Side mirror	
Adjusting and folding.....	134
Mirror position memory	115
Side turn signal lights	
Replacing light bulbs.....	688
Smart entry & start system	
Antenna location	43
Entry function	39
Starting the engine.....	239
Spare tire	
Inflation pressure	840
Storage location	743
Spark plug	833
Specifications	812
Speedometer.....	266
Steering	
Column lock release	237, 246
Fluid	839
Steering wheel	
Adjustment	129
Audio switches	501
Steering wheel position memory.....	115
Stop lights	
Replacing light bulbs.....	688
Storage compartment.....	598
Storage feature	562
Storage precautions	393
Stuck	
If your vehicle becomes stuck	807
Sun visors	579
Sunshade	
Roof	142
Switch	
Airbag manual on-off system	213
"ENGINE START STOP" switch	239
Engine switch.....	235, 243
Fog light switch	312
Ignition switch	235, 243
Light switches	300
Power door lock switch	74
Power window switch.....	137
Rear window wiper and washer switch.....	320
Window lock switch.....	137
Wipers and washer switch	314, 320
Tachometer	266
Tail lights	
Replacing light bulbs.....	688
Switch	300
Talk switch*2	533
Telephone switch*2.....	533
Theft deterrent system	
Alarm	160
Double locking system.....	158
Engine immobilizer system...	152
Intrusion sensor	162
Tilt sensor	162
Tilt sensor	162
Tire inflation pressure.....	649
Tires	
Chains.....	396
Checking.....	645
If you have a flat tire	743, 765
Inflation pressure	649
Replacing.....	743, 765
Rotating tires.....	645

Size 840
 Snow tires 396
 Spare tire 743
Tools 743, 765
Towing
 Emergency towing 694
 Trailer towing 400
Toyota parking
assist-sensor 345
Traction control 373
Trailer towing 400
TRC 373
Trip information
display 276, 282, 292
Trip meter 266

V **Valet key 34**
Vanity lights
 Vanity lights 580
 Wattage 843
Vanity mirrors 580
Vehicle identification
number 815
Vehicle stability control 373
VSC 373

W **Warning buzzers**
 Brake system 703, 725
 Driver's seat belt reminder 709
 Front passenger's seat belt
 reminder 709
 Fuel filter 706, 729
 Glass hatch 724
 Open door 708, 723
 Radar cruise control 727
 Third power seat 109
 Toyota parking
 assist-sensor 728

Warning lights
 Automatic transmission fluid
 temperature 706
 Anti-lock brake system 705
 Brake system 703
 Charging system 704
 Driver's seat belt reminder 709
 Engine oil change
 reminder 710
 Front passenger's seat belt
 reminder 709
 Fuel filter 706
 KDSS 706
 Low engine oil level 710
 Low engine oil pressure 704
 Low fuel level 708
 Malfunction indicator lamp 705
 Master warning light 709
 Open door 708
 Power steering system 705
 Pre-crash safety system 705
 Seat belt reminder light 708
 Slip indicator light 706
 Smart entry & start system ... 712
 SRS airbags 705
 Timing belt replacement 706

Warning messages
 Automatic transmission fluid
 temperature 720
 Brake system 725
 Clutch switch system 722
 Crawl control 740
 Engine oil maintenance 726
 Engine oil level 725
 Engine oil pressure 719
 Four-wheel drive system 740
 Fuel filter 725
 Glass hatch 724
 Low fuel level 729

*2: Refer to the "Navigation System Owner's Manual".

Alphabetical index

Moon roof.....	724
Open door.....	723
Pre-crash brake	729
Pre-crash safety system	721, 727
Radar cruise control system	721, 728
Rear height control air suspension system.....	720
Smart entry & start system....	730
Steering lock system.....	720
Timing belt replacement.....	727
Toyota parking assist....	721, 727
Warning reflector holder.....	599
Washer	
Checking.....	641
Preparing and checking before winter.....	396
Switch	314, 320
Washing and waxing	606
Weight.....	812
Wheels	652
Wide view front & side monitor.....	361
Window glasses	137
Window lock switch.....	137
Windows	
Power windows	137
Rear window defogger	444
Washer.....	314, 320
Windshield wiper de-icer	447
Windshield wipers	314
Wireless remote control key	
Locking/Unlocking.....	66
Replacing the battery	656
Wireless remote control key....	66
WMA disc.....	468

**What to do if...
What to do if...**

A tire punctures	P. 743, 765	If you have a flat tire
The engine does not start	P. 786	If the engine will not start
	P. 806	If you run out of fuel and the engine stalls
	P. 152	Engine immobilizer system
	P. 795	If the vehicle battery is discharged
The shift lever cannot be moved out	P. 789	If the shift lever cannot be shifted from "P"
The engine coolant temperature gauge enters the red zone	P. 803	If your vehicle overheats
Steam can be seen coming from under the hood		
The key is lost	P. 790	If you lose your keys/wireless remote control transmitter
The battery runs out	P. 795	If the vehicle battery is discharged
The doors cannot be locked	P. 74	Side doors
	P. 81	Back door
The horn begins to sound	P. 160	Alarm
The vehicle is stuck in mud or sand	P. 807	If the vehicle becomes stuck

What to do if...

The warning light or indicator light comes on

P. 703 If a warning light turns on

■ Instrument cluster

Non-Optitron type meters

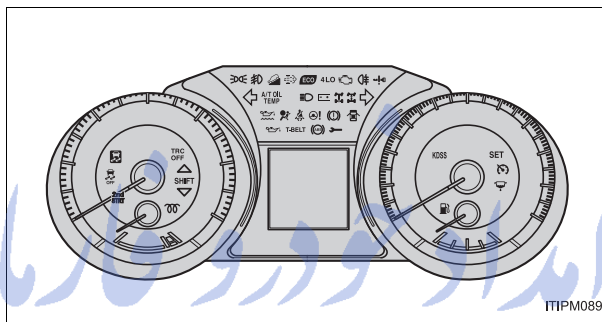

Optitron type meters

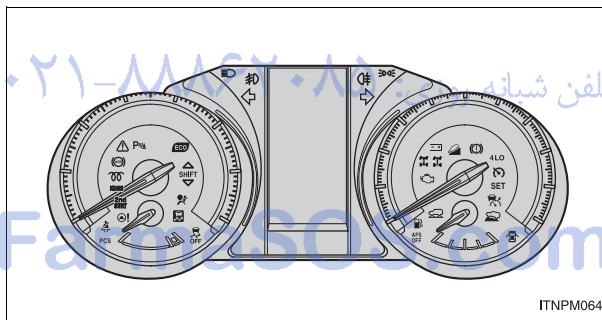

■ Center panel

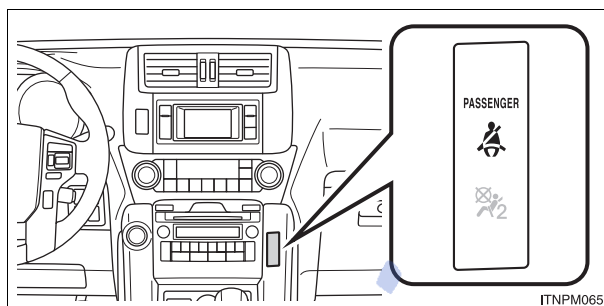























امداد خودرو فارما

تلفن شبانه روزی: ۰۲۱-۸۸۸۶۲۰۸۵

FarmaSOS.com

■ Warning lights

	Brake system warning light P. 703		Fuel filter warning light P. 706
	Charging system warning light P. 704		Fuel system warning light P. 707
	Low engine oil pressure warning light P. 704		DPF system warning light P. 707
	Malfunction indicator lamp P. 705		Open door warning light P. 708
	SRS warning light P. 705		Low fuel level warning light P. 708
	ABS warning light P. 705		Driver's seat belt reminder light P. 709
	Power steering system warning light P. 705		Front passenger's seat belt reminder light P. 709
	Pre-crash safety system warning light P. 705		Master warning light P. 709
	Slip indicator light P. 706		Low engine oil level warning light P. 710
	Automatic transmission fluid temperature warning light P. 706		Engine oil change reminder light P. 710
	KDSS warning light P. 706		Smart entry & start system warning light P. 712
	Timing belt replacement warning light P. 706		

The warning message is displayed

P. 718 If a warning message is displayed

امداد خودرو فارما

تلفن شبانه روزی: ۰۲۱-۸۸۸۶۲۰۸۵

FarmaSOS.com

GAS STATION INFORMATION

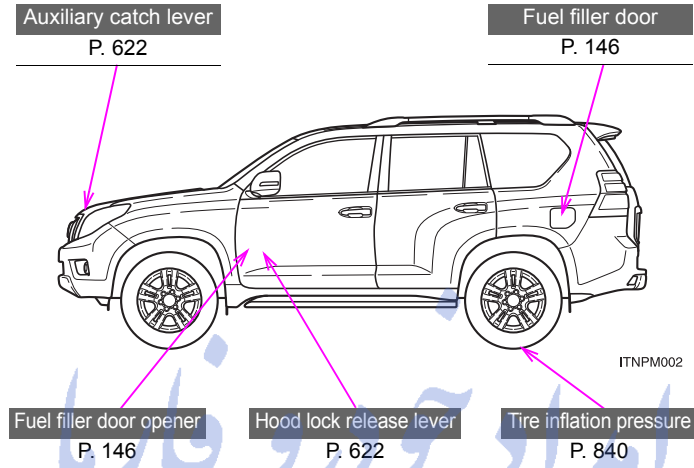

Fuel tank capacity (Reference)	Vehicles with sub fuel tank system	150 L (39.6 gal., 33.0 Imp.gal.)
	Vehicles with- out sub fuel tank system	87 L (23.0 gal., 19.1 Imp.gal.)
Fuel type		P. 148, 818
Cold tire inflation pressure		P. 840
Engine oil capacity (Drain and refill — reference)		P. 819
Engine oil type		P. 819