

TABLE OF CONTENTS

1	Before driving	Adjusting and operating features such as door locks, mirrors, and steering column
2	When driving	Driving, stopping and safe-driving information
3	Interior features	Air conditioning and audio systems, as well as other interior features for a comfortable driving experience
4	Maintenance and care	Cleaning and protecting your vehicle, performing do-it-yourself maintenance, and maintenance information
5	When trouble arises	What to do if the vehicle needs to be towed, gets a flat tire, or is involved in an accident
6	Vehicle specifications	Detailed vehicle information
7	For U.S. owners	Reporting safety defects for U.S. owners
	Index	Alphabetical listing of information contained in this manual

For vehicles with a navigation system, refer to the “Navigation System Owner’s Manual” for information regarding the equipment listed below.

- Navigation system
- Air conditioning
- Climate control
- Audio/video system
- Rear view monitor system

<p>1 Before driving</p> <hr/> <p>1-1. Key information</p> <p>Keys 30</p> <p>1-2. Opening, closing and locking the doors</p> <p>Smart key system..... 32</p> <p>Wireless remote control 44</p> <p>Side doors 46</p> <p>Back door 51</p> <p>1-3. Adjustable components (seats, mirrors, steering wheel)</p> <p>Front seats 57</p> <p>Rear seats 59</p> <p>Driving position memory system..... 68</p> <p>Head restraints..... 72</p> <p>Seat belts 76</p> <p>Steering wheel 86</p> <p>Inside rear view mirror..... 88</p> <p>Outside rear view mirrors 90</p>	<p>1-4. Opening and closing the windows and moon roof</p> <p>Power windows..... 93</p> <p>Moon roof 97</p> <p>1-5. Refueling</p> <p>Opening the fuel tank cap..... 101</p> <p>1-6. Theft deterrent system</p> <p>Engine immobilizer system 105</p> <p>Alarm 107</p> <p>1-7. Safety information</p> <p>Correct driving posture 111</p> <p>SRS airbags 113</p> <p>Front passenger occupant classification system..... 129</p> <p>Child restraint systems 135</p> <p>Installing child restraints 140</p>
----------------------------------------------------------------------------------------------------------------------------------------------------------------------------------------------------------------------------------------------------------------------------------------------------------------------------------------------------------------------------------------------------------------------------------------------------------------------------------------------------------------------------------------------------------------------------------------------------------------------------------------------	-----------------------------------------------------------------------------------------------------------------------------------------------------------------------------------------------------------------------------------------------------------------------------------------------------------------------------------------------------------------------------------------------------------------------------------------------------------------------------------------------------------------------------------------------------------------------------

2 When driving

2-1. Driving procedures

Driving the vehicle.....	154
Engine (ignition) switch	166
Automatic transmission.....	171
Turn signal lever	176
Parking brake.....	177
Horn	178

2-2. Instrument cluster

Gauges and meters	179
Indicators and warning lights	184
Multi-information display	189

2-3. Operating the lights and wipers

Headlight switch.....	196
Fog light switch	201
Windshield wipers and washer	202
Rear window wiper and washer	208
Headlight cleaner switch	209

2-4. Using other driving systems

Cruise control	210
Dynamic radar cruise control	214
Intuitive parking assist.....	229
Four-wheel drive system	240
Crawl Control (with Turn Assist function).....	245
Multi-terrain Select	251
Multi-terrain Monitor	257
Driving assist systems.....	281
Pre-Collision System	289

2-5. Driving information

Off-road precautions.....	296
Cargo and luggage.....	301
Vehicle load limits.....	308
Winter driving tips.....	309
Trailer towing.....	314
Dinghy towing.....	332

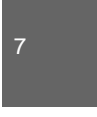
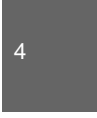
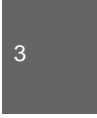

3 Interior features

3-1. Using the air conditioning system and defogger

Front air conditioning system..... 336
 Rear air conditioning system..... 347
 Rear window and outside rear view mirror defoggers 351
 Windshield wiper de-icer 352

3-2. Using the audio system

Audio system type..... 353
 Using the radio 356
 Using the CD player 365
 Playing back MP3 and WMA discs 373
 Operating an iPod 380
 Operating a USB memory 387
 Optimal use of the audio system..... 395
 Using the AUX port 397
 Using the steering switches 398

3-3. Using the Bluetooth® audio system

Bluetooth® audio system 402
 Using the Bluetooth® audio system 406
 Operating a Bluetooth® enabled portable player..... 412
 Setting up a Bluetooth® enabled portable player..... 415
 Bluetooth® audio system setup..... 422

3-4. Using the hands-free system (for cellular phone)

Hands-free system (for cellular phone) 423
 Using the hands-free system 428
 Making a phone call..... 436
 Setting a cellular phone 441
 Security and system setup..... 447
 Using the phone book..... 453

3-5. Using the interior lights

Interior lights list..... 462
 • Interior lights 463
 • Personal lights 464

3-6. Using the storage features

List of storage features 466

- Glove box..... 467
- Console box..... 468
- Overhead console..... 469
- Cup holders 470
- Bottle holders 472
- Card holders 474
- Auxiliary boxes..... 474

3-7. Other interior features

Cool box..... 475

Sun visors 477

Vanity mirror..... 478

Clock..... 479

Outside temperature display..... 480

Ashtrays 482

Cigarette lighter..... 484

Power outlets 485

Heated steering wheel 487

Seat heaters and ventilators 489

Armrest 491

Assist grips..... 492

Floor mats..... 493

Luggage compartment features..... 495

Garage door opener..... 497

Safety Connect 504

4 Maintenance and care

4-1. Maintenance and care

Cleaning and protecting the vehicle exterior 512

Cleaning and protecting the vehicle interior 515

4-2. Maintenance

Maintenance requirements 518

General maintenance 521

Emission inspection and maintenance (I/M) programs 524

4-3. Do-it-yourself maintenance

Do-it-yourself service precautions..... 525

Hood..... 528

Engine compartment 529

Tires 544

Tire inflation pressure..... 553

Wheels 557

Air conditioning filter 560

Electronic key battery 563

Checking and replacing fuses..... 566

Headlight aim 580

Light bulbs..... 582

1

2

3

4

5

6

7

5 When trouble arises

5-1. Essential information

Emergency flashers 600
 If your vehicle needs to
 be towed 601
 If you think something
 is wrong..... 606
 Fuel pump shut off
 system..... 607

5-2. Steps to take in an emergency

If a warning light turns on
 or a warning buzzer
 sounds... 608
 If a warning message
 is displayed 619
 If you have a flat tire 635
 If the engine will not start ... 649
 If the shift lever cannot be
 shifted from P..... 651
 If you lose your keys 652
 If the electronic key does
 not operate properly..... 653
 If the battery is
 discharged 656
 If your vehicle overheats 659
 If the vehicle becomes
 stuck..... 662
 If your vehicle has to be
 stopped in an
 emergency 664

6 Vehicle specifications

6-1. Specifications

Maintenance data
 (fuel, oil level, etc.) 668
 Fuel information 678
 Tire information..... 682

6-2. Customization

Customizable features 694

6-3. Initialization

Items to initialize 703

7 For U.S. owners

Reporting safety defects
 for U.S. owners..... 706

Index

Abbreviation list 708

Alphabetical index..... 710

What to do if... 720

امداد خودرو فارما

تلفن شبانه روزی: ۰۲۱-۸۸۸۶۲۰۸۵

FarmaSOS.com

1

2

3

4

5

6

7

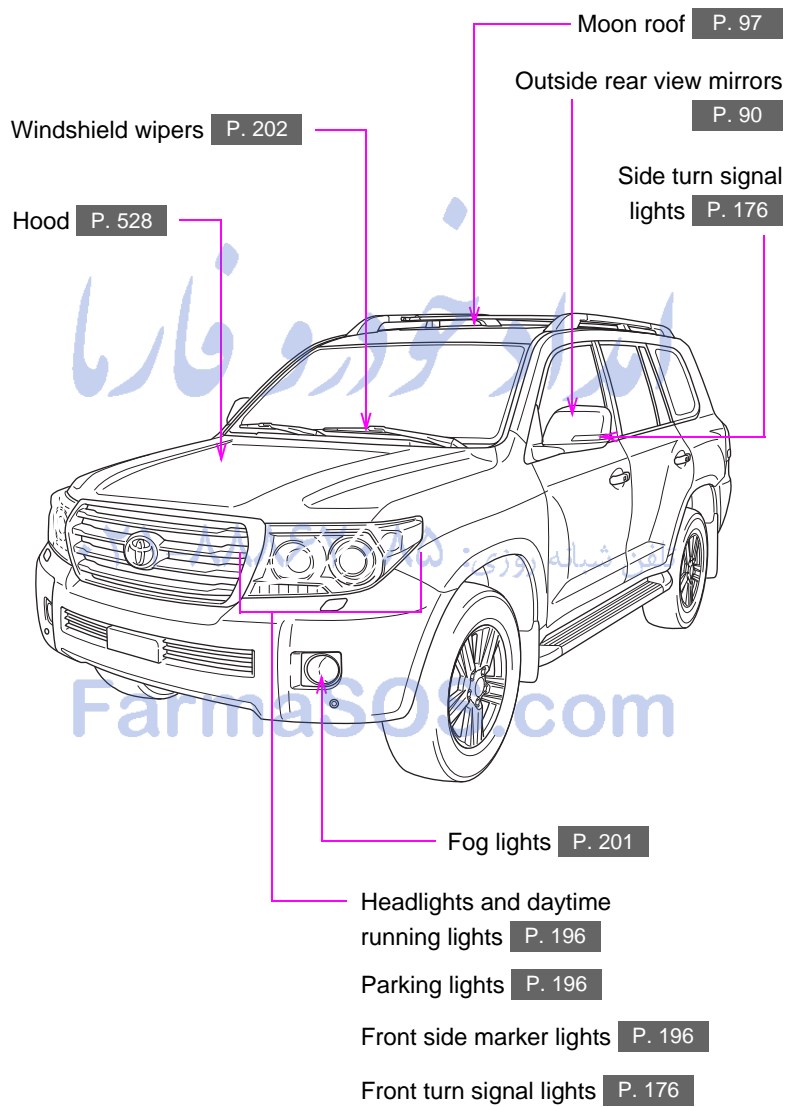

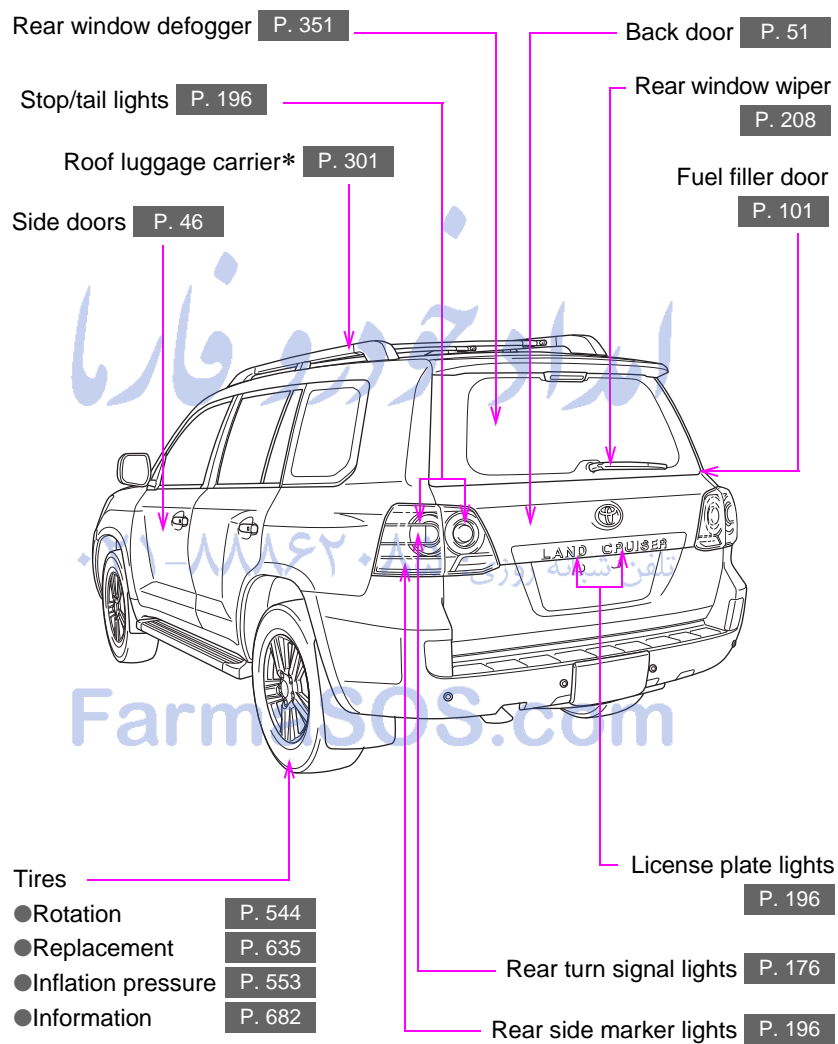

*: If equipped

Pictorial index

Interior

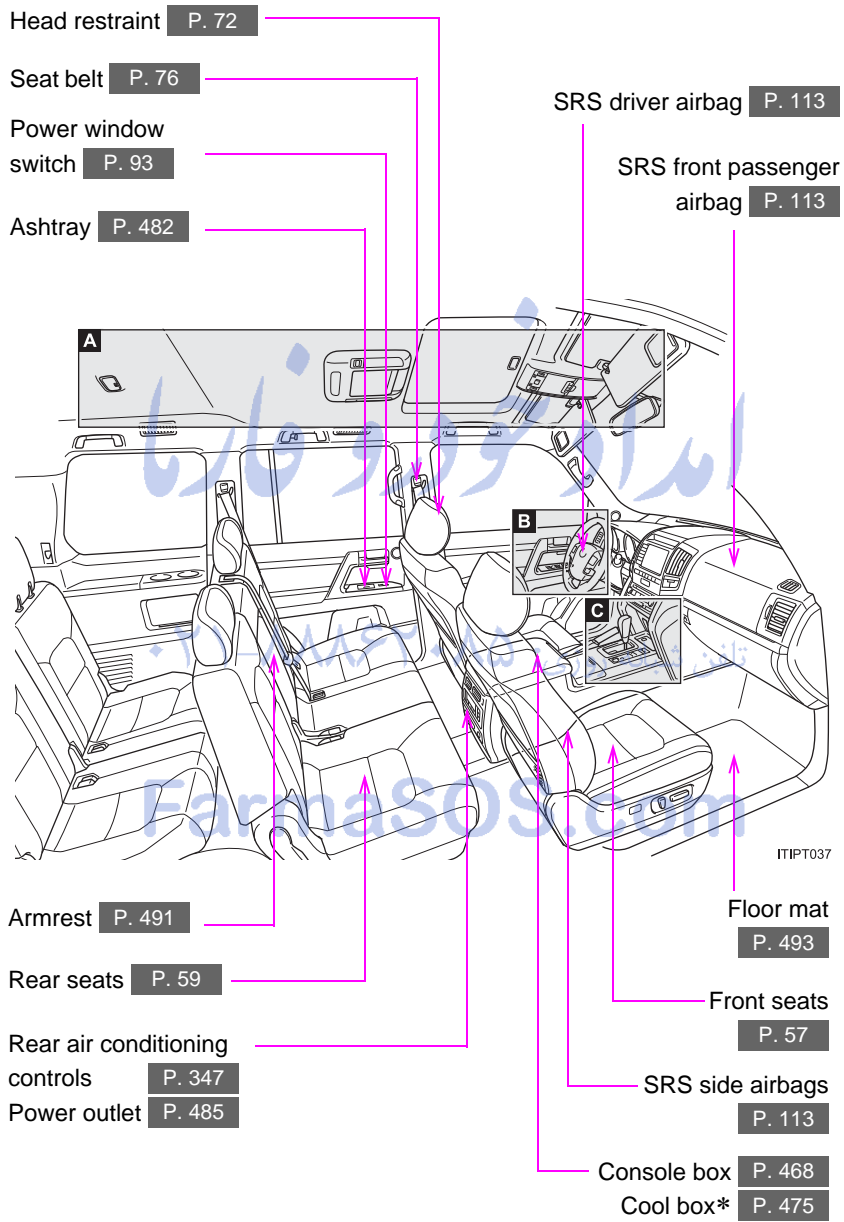

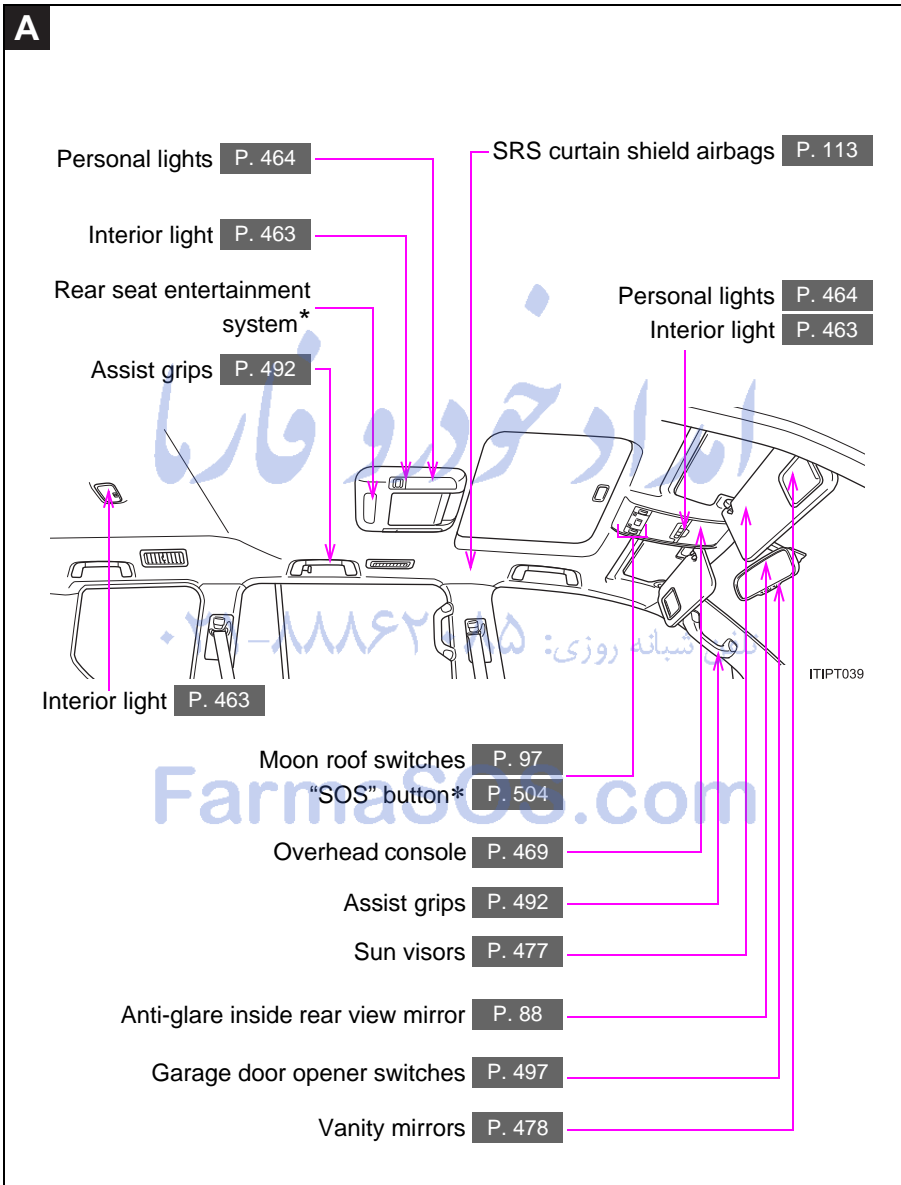

*: If equipped

*: Refer to "Navigation System Owner's Manual".

B

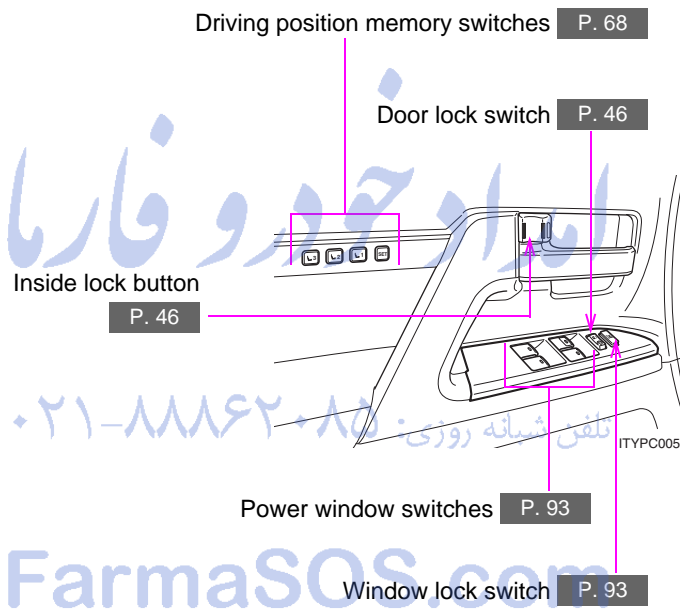

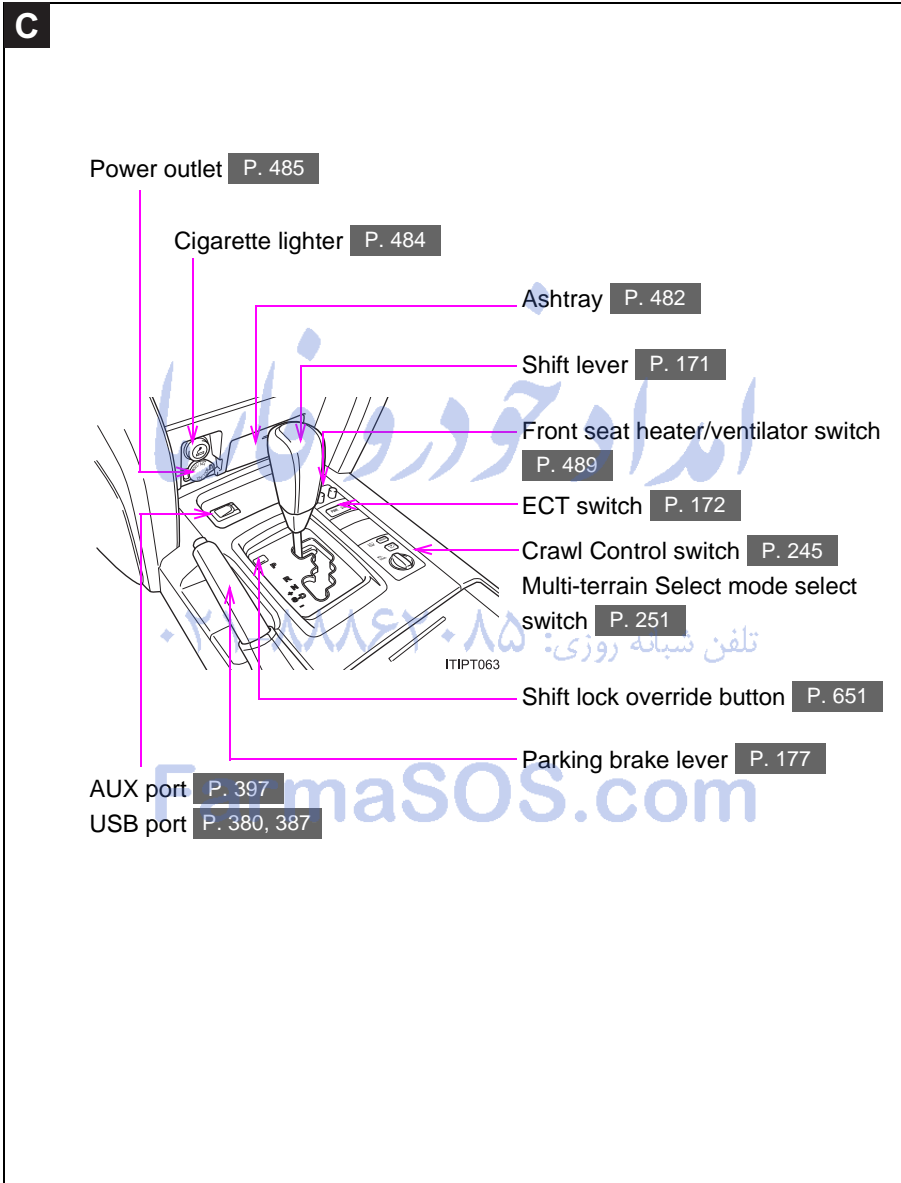

Pictorial index

Instrument panel

Headlight switch P. 196

Turn signal lever P. 176

Fog light switch P. 201

Gauges and meters P. 179

Multi-information display P. 189

Windshield wipers and washer switch P. 202

Rear window wiper and washer switch P. 208

Glove box P. 467

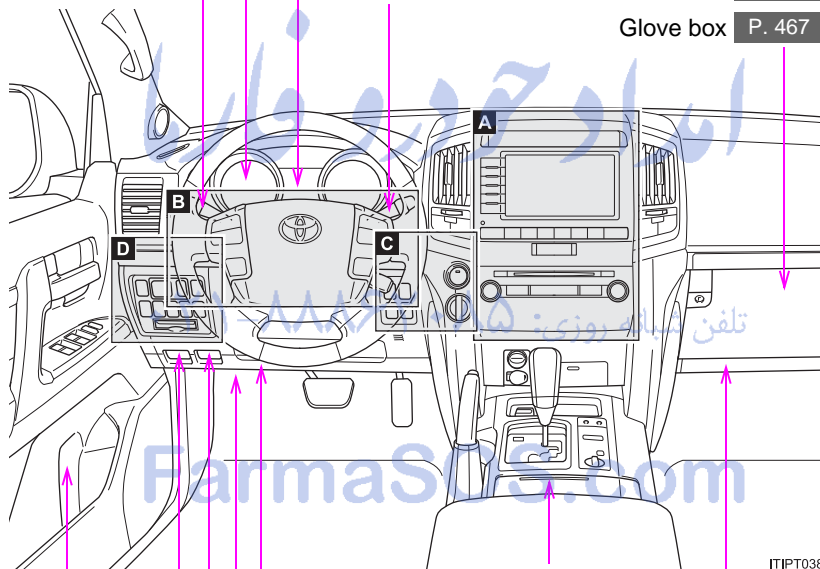

Cup holders P. 470

ITIPT038

SRS knee airbags P. 113

Tire pressure warning reset switch P. 544

Hood opener P. 528

Fuel filler door opener P. 101

Bottle holder P. 472

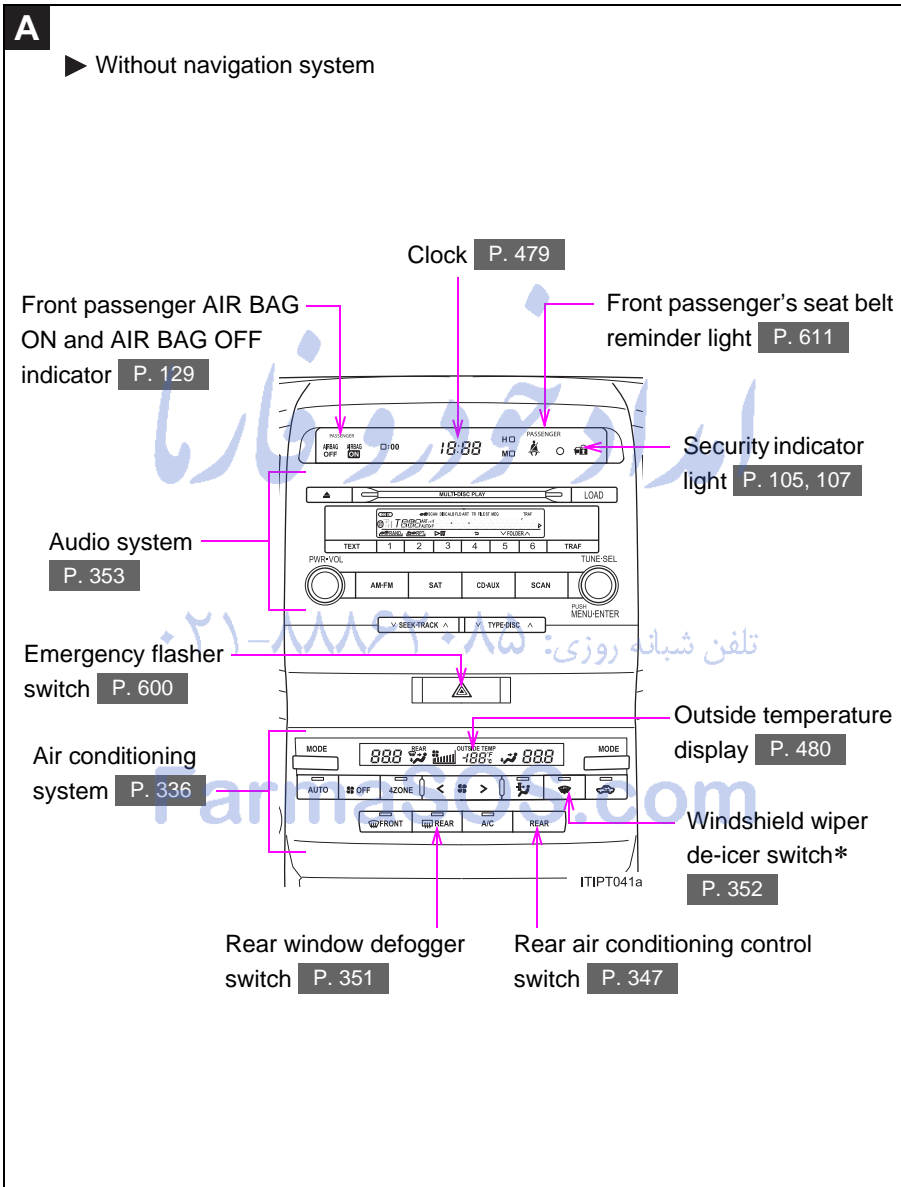

*: If equipped

A

► With navigation system

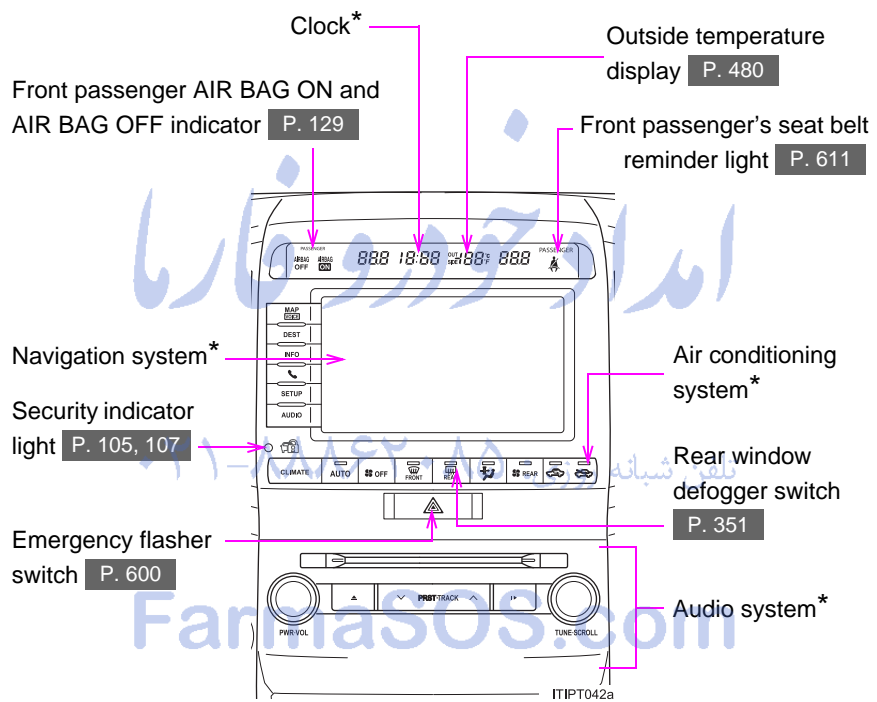

B

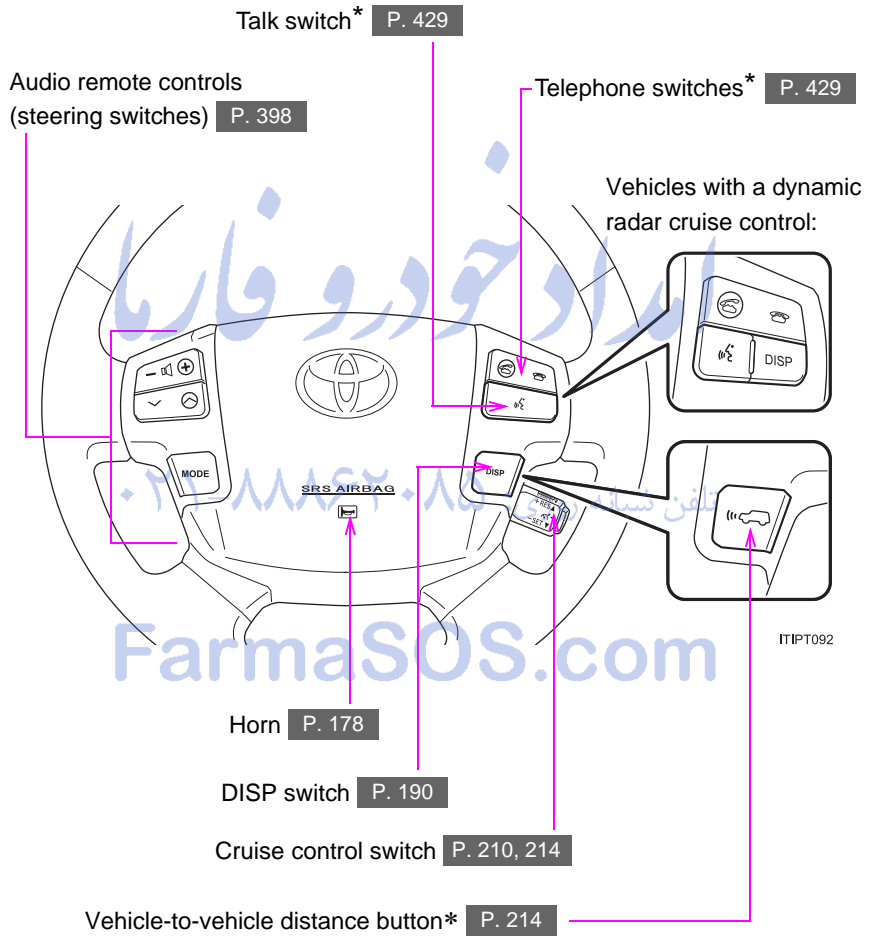

*: If equipped
*: Refer to "Navigation System Owner's Manual".

C

VIEW switch* P. 257

Engine (ignition) switch P. 166

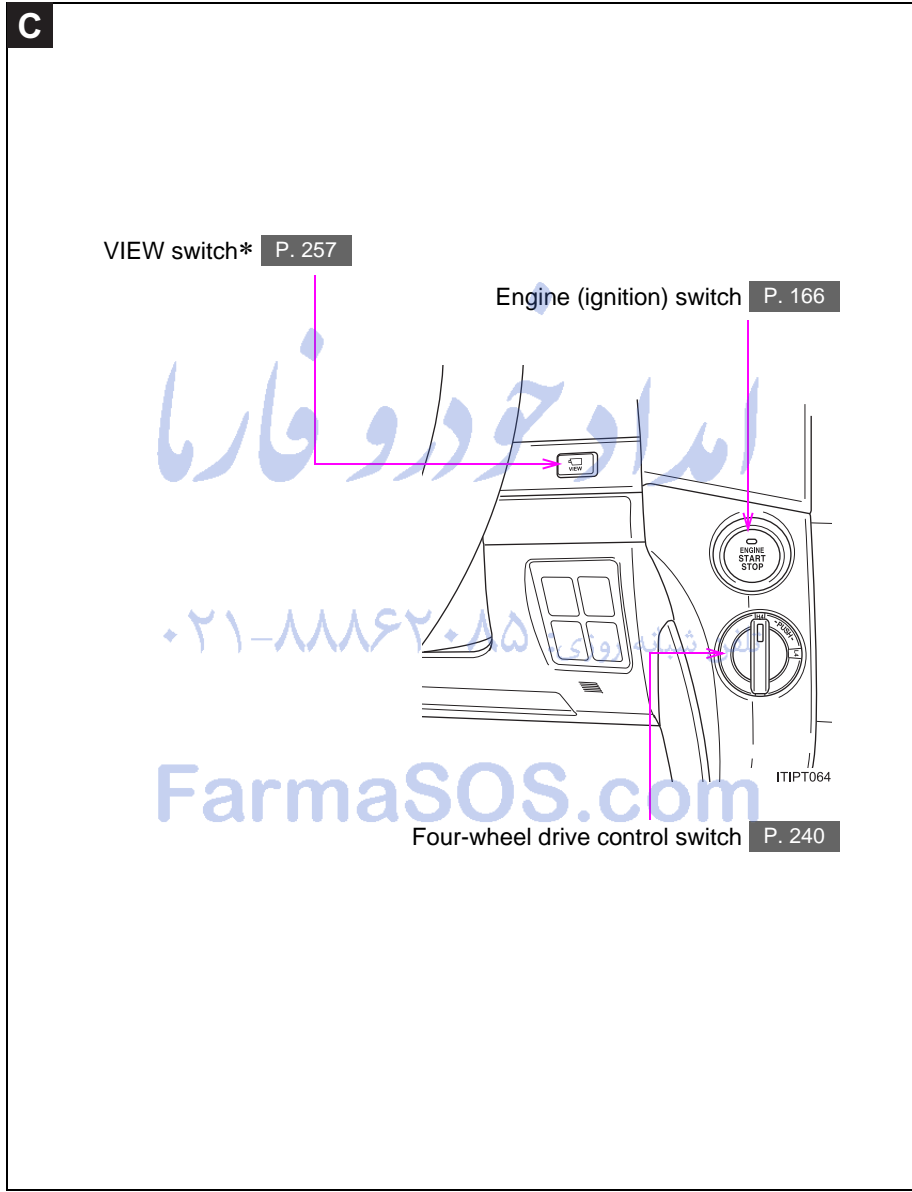

Four-wheel drive control switch P. 240

D

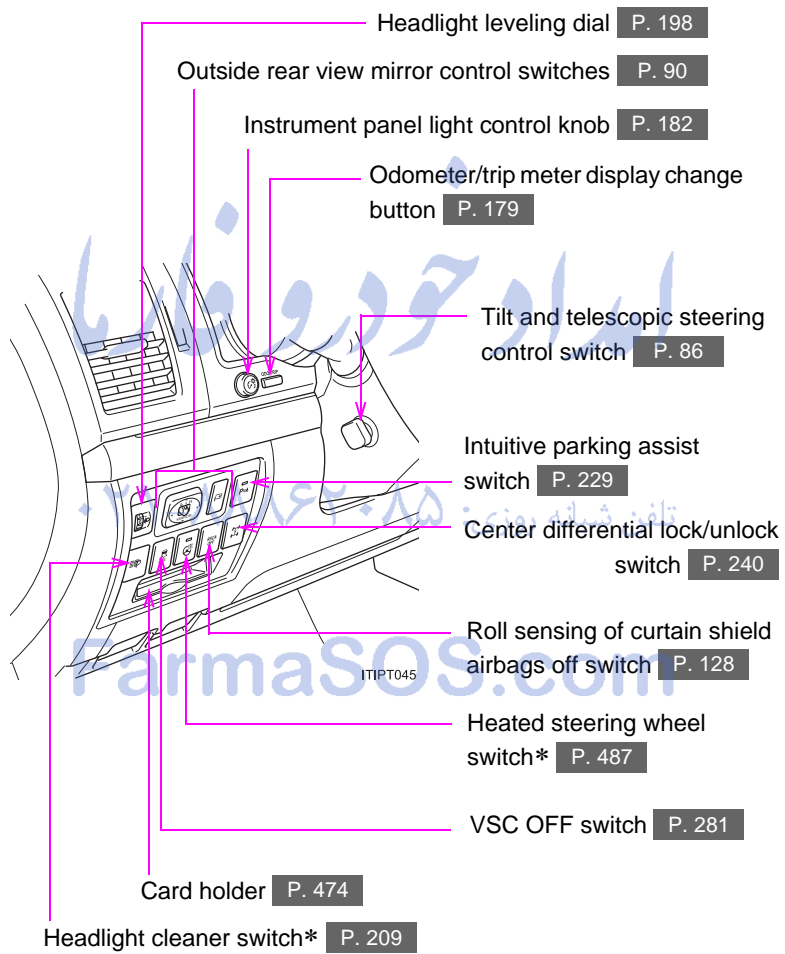

*: If equipped

Head restraint angle lever P. 72

Seatback handles P. 63

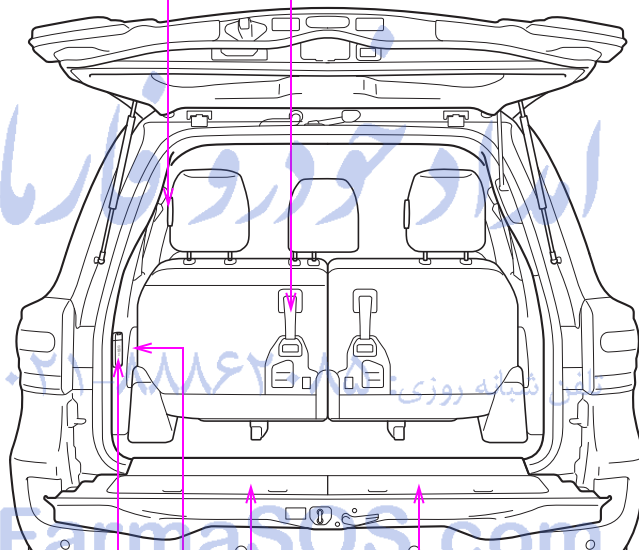

ITIPT046a

Power outlet P. 485

Tools P. 635

Seatback angle lever P. 59

Warning reflector holder P. 496

امداد خودرو فارما

تلفن شبانه روزی: ۰۲۱-۸۸۸۶۲۰۸۵

FarmaSOS.com

For your information

Main Owner's Manual

Please note that this manual applies to all models and explains all equipment, including options. Therefore, you may find some explanations for equipment not installed on your vehicle.

All specifications provided in this manual are current at the time of printing. However, because of the Toyota policy of continual product improvement, we reserve the right to make changes at any time without notice.

Depending on specifications, the vehicle shown in the illustration may differ from your vehicle in terms of equipment.

Noise from under vehicle after turning off the engine

Approximately five hours after the engine is turned off, you may hear sound coming from under the vehicle for several minutes. This is the sound of a fuel evaporation leakage check and, it does not indicate a malfunction.

Accessories, spare parts and modification of your Toyota

A wide variety of non-genuine spare parts and accessories for Toyota vehicles are currently available in the market. You should know that Toyota does not warrant these products and is not responsible for their performance, repair, or replacement, or for any damage they may cause to, or adverse effect they may have on, your Toyota vehicle.

This vehicle should not be modified with non-genuine Toyota products. Modification with non-genuine Toyota products could affect its performance, safety or durability, and may even violate governmental regulations. In addition, damage or performance problems resulting from the modification may not be covered under warranty.

Installation of a mobile two-way radio system

The installation of a mobile two-way radio system in your vehicle could affect electronic systems such as:

- Multiport fuel injection system/sequential multiport fuel injection system
- Cruise control system
- Dynamic radar cruise control system
- Anti-lock brake system
- SRS airbag system
- Seat belt pretensioner system

Be sure to check with your Toyota dealer for precautionary measures or special instructions regarding installation of a mobile two-way radio system.

تلفن شبانه روزی: ۰۲۱-۸۸۸۶۲۰۸۵

FarmaSOS.com

Vehicle data recordings

Your Toyota is equipped with several sophisticated computers that will record certain data, such as:

- Engine speed
- Accelerator status
- Brake status
- Vehicle speed
- Shift position

The recorded data varies according to the vehicle grade level and options with which it is equipped. Furthermore, these computers do not record conversations, sounds or pictures.

● Data usage

Toyota may use the data recorded in these computers to diagnose malfunctions, conduct research and development, and improve quality.

Toyota will not disclose the recorded data to a third party except:

- With the consent of the vehicle owner or with the consent of the lessee if the vehicle is leased
- In response to an official request by the police, a court of law or a government agency
- For use by Toyota in a lawsuit
- For research purposes where the data is not tied to a specific vehicle or vehicle owner
- Usage of data collected through Safety Connect (U.S. mainland only)

If your Toyota has Safety Connect and if you have subscribed to those services, please refer to the Safety Connect Telematics Subscription Service Agreement for information on data collected and its usage.

Event data recorder

This vehicle is equipped with an event data recorder (EDR). The main purpose of an EDR is to record, in certain crash or near crash-like situations, such as an air bag deployment or hitting a road obstacle, data that will assist in understanding how a vehicle's systems performed. The EDR is designed to record data related to vehicle dynamics and safety systems for a short period of time, typically 30 seconds or less.

The EDR in this vehicle is designed to record such data as:

- How various systems in your vehicle were operating;
- Whether or not the driver and passenger safety belts were buckled/fastened;
- How far (if at all) the driver was depressing the accelerator and/or brake pedal; and,
- How fast the vehicle was traveling.

These data can help provide a better understanding of the circumstances in which crashes and injuries occur.

NOTE: EDR data are recorded by your vehicle only if a nontrivial crash situation occurs; no data are recorded by the EDR under normal driving conditions and no personal data (e.g., name, gender, age, and crash location) are recorded. However, other parties, such as law enforcement, could combine the EDR data with the type of personally identifying data routinely acquired during a crash investigation.

To read data recorded by an EDR, special equipment is required, and access to the vehicle or the EDR is needed. In addition to the vehicle manufacturer, other parties, such as law enforcement, that have the special equipment, can read the information if they have access to the vehicle or the EDR.

- Disclosure of the EDR data

Toyota will not disclose the data recorded in an EDR to a third party except when:

- An agreement from the vehicle's owner (or the lessee for a leased vehicle) is obtained
- In response to an official request by the police, a court of law or a government agency
- For use by Toyota in a lawsuit

However, if necessary, Toyota may:

- Use the data for research on vehicle safety performance
- Disclose the data to a third party for research purposes without disclosing information about the specific vehicle or vehicle owner

Scraping of your Toyota

The SRS airbag and seat belt pretensioner devices in your Toyota contain explosive chemicals. If the vehicle is scrapped with the airbags and seat belt pretensioners left as they are, this may cause an accident such as fire. Be sure to have the systems of the SRS airbag and seat belt pretensioner removed and disposed of by a qualified service shop or by your Toyota dealer before you scrap your vehicle.

Perchlorate Material

Special handling may apply. See www.dtsc.ca.gov/hazardouswaste/perchlorate. Your vehicle has components that may contain perchlorate. These components may include airbag, seat belt pretensioners, and wireless remote control batteries.

 CAUTION

■ **General precautions while driving**

Driving under the influence: Never drive your vehicle when under the influence of alcohol or drugs that have impaired your ability to operate your vehicle. Alcohol and certain drugs delay reaction time, impair judgment and reduce coordination, which could lead to an accident that could result in death or serious injury.

Defensive driving: Always drive defensively. Anticipate mistakes that other drivers or pedestrians might make and be ready to avoid accidents.

Driver distraction: Always give your full attention to driving. Anything that distracts the driver, such as adjusting controls, talking on a cellular phone or reading can result in a collision with resulting death or serious injury to you, your occupants or others.

■ **General precaution regarding children's safety**

Never leave children unattended in the vehicle, and never allow children to have or use the key.

Children may be able to start the vehicle or shift the vehicle into neutral. There is also a danger that children may injure themselves by playing with the cigarette lighter, the windows, the moon roof, or other features of the vehicle. In addition, heat build-up or extremely cold temperatures inside the vehicle can be fatal to children.

FarmaSOS.com

Symbols used throughout this manual

Cautions & Notices

CAUTION

This is a warning against anything which may cause injury to people if the warning is ignored. You are informed about what you must or must not do in order to reduce the risk of injury to yourself and others.

NOTICE

This is a warning against anything which may cause damage to the vehicle or its equipment if the warning is ignored. You are informed about what you must or must not do in order to avoid or reduce the risk of damage to your Toyota and its equipment.

Symbols used in illustrations



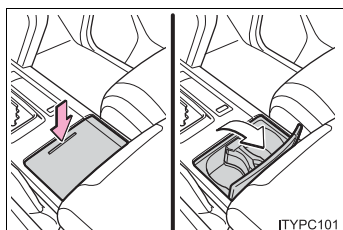

Safety symbol

The symbol of a circle with a slash through it means “Do not”, “Do not do this”, or “Do not let this happen”.



Arrows indicating operations

-  Indicates the action (pushing, turning, etc.) used to operate switches and other devices.
-  Indicates the outcome of an operation (e.g. a lid opens).

Before driving

1

1-1. Key information		1-4. Opening and closing the windows and moon roof	
Keys	30	Power windows	93
1-2. Opening, closing and locking the doors		Moon roof	97
Smart key system	32	1-5. Refueling	
Wireless remote control	44	Opening the fuel tank cap	101
Side doors	46	1-6. Theft deterrent system	
Back door	51	Engine immobilizer system	105
1-3. Adjustable components (seats, mirrors, steering wheel)		Alarm	107
Front seats	57	1-7. Safety information	
Rear seats	59	Correct driving posture	111
Driving position memory system	68	SRS airbags	113
Head restraints	72	Front passenger occupant classification system	129
Seat belts	76	Child restraint systems	135
Steering wheel	86	Installing child restraints	140
Inside rear view mirror	88		
Outside rear view mirrors	90		

1-1. Key information Keys

The following keys are provided with the vehicle.

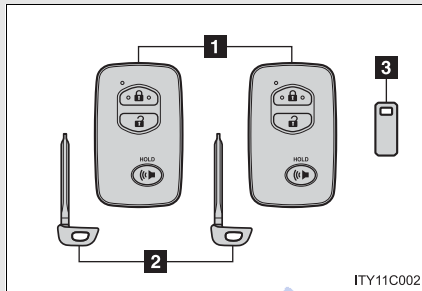

1 Electronic keys

- Operating the smart key system (→P. 32)
- Operating the wireless remote control function (→P. 44)

2 Mechanical keys

3 Key number plate

Using the mechanical key

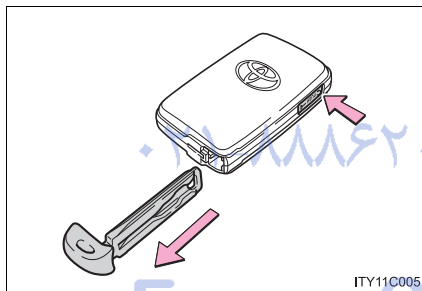

Take out the mechanical key.

After using the mechanical key, store it in the electronic key. Carry the mechanical key together with the electronic key. If the electronic key battery depletes or entry function does not operate properly, you will need the mechanical key. (→P. 653)

■ When required to leave the vehicle's key with a parking attendant

Lock the glove box as circumstances demand. (→P. 467)

Remove the mechanical key for your own use and provide the attendant with the electronic key only.

■ Key number plate

Keep the plate in a safe place such as your wallet, not in the vehicle. In the event that a key is lost, a new key can be made at your Toyota dealer using the key number plate. (→P. 652)

■ When riding in an aircraft

When bringing an electronic key onto an aircraft, make sure you do not press any buttons on the electronic key while inside the aircraft cabin. If you are carrying an electronic key in your bag etc., ensure that the buttons are not likely to be pressed accidentally. Pressing a button may cause the electronic key to emit radio waves that could interfere with the operation of the aircraft.

⚠ NOTICE

■ To prevent key damage

- Do not subject the keys to strong shocks, expose them to high temperatures by placing them in direct sunlight, or get them wet.
- Do not expose the keys to electromagnetic materials or attach any material that blocks electromagnetic waves to the key surface.
- Do not disassemble the electronic key.

1-2. Opening, closing and locking the doors Smart key system

The following operations can be performed simply by carrying the electronic key on your person, for example in your pocket.
(The driver should always carry the electronic key.)

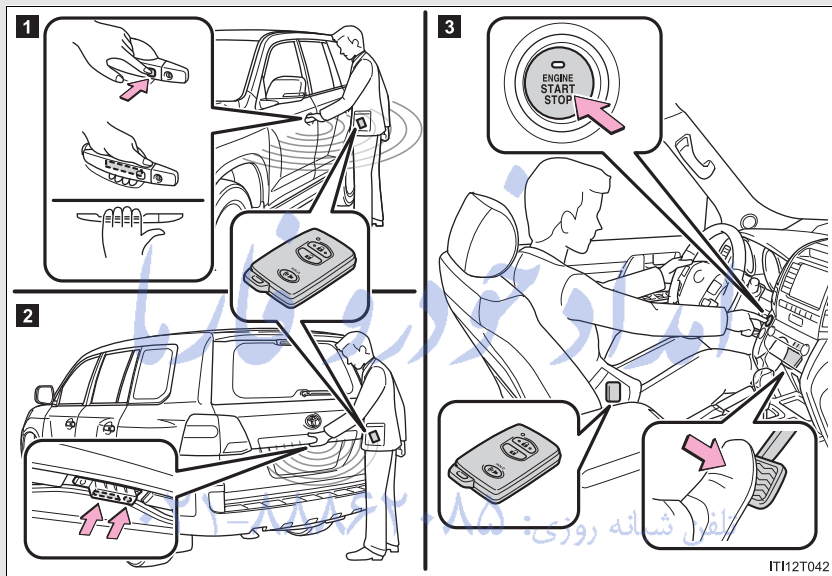

- 1** Locks and unlocks the doors (→P. 33)
- 2** Locks and unlocks the doors (→P. 33)
- 3** Starts and stops the engine (→P. 166)

Unlocking and locking the doors

► Side door handle

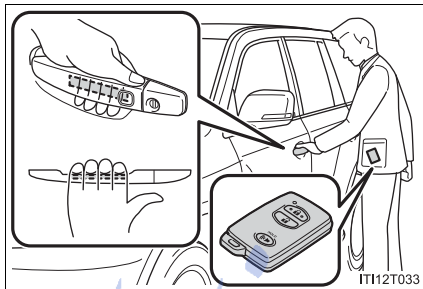

Grip the driver's door handle to unlock the door. Grip the passenger's door handle to unlock all the doors.*

Make sure to touch the sensor on the back of the handle.

The doors cannot be unlocked for 3 seconds after the doors are locked.

*: The door unlock settings can be changed. (→P. 37)

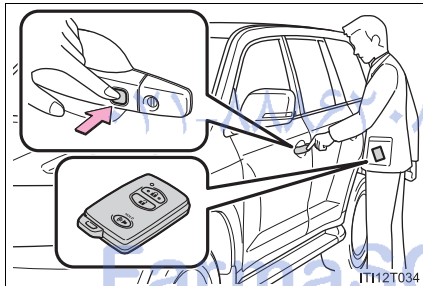

Press the lock button to lock the doors.

Pressing and holding the button closes the windows and moon roof. (This setting must be customized at your Toyota dealer.)

► Back door

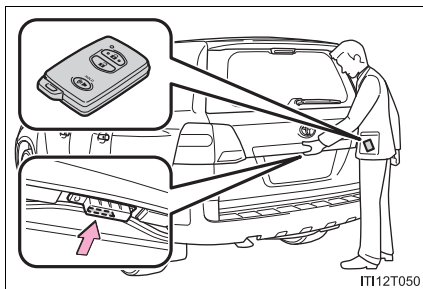

Press the unlock button to unlock the doors.

The door cannot be unlocked for 3 seconds after the door is locked.

Lock the back door again when you leave the vehicle. The back door will not lock automatically after it has been opened and then closed.

1

Before driving

1-2. Opening, closing and locking the doors

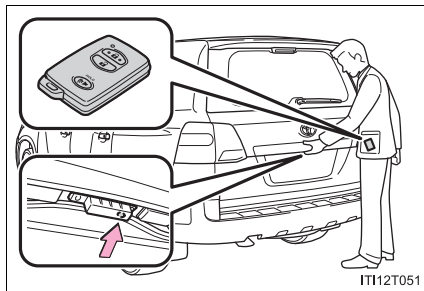

Press the lock button to lock the doors.

Antenna location and effective range

■ Antenna location

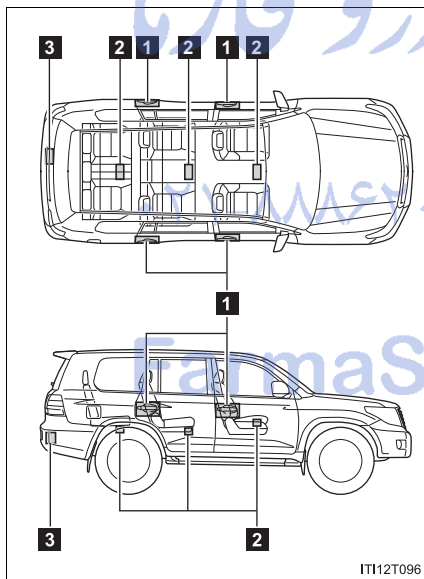

- 1 Antennas outside cabin
- 2 Antennas inside cabin
- 3 Antenna outside luggage compartment

1-2. Opening, closing and locking the doors

■ Effective range (areas within which the electronic key is detected)

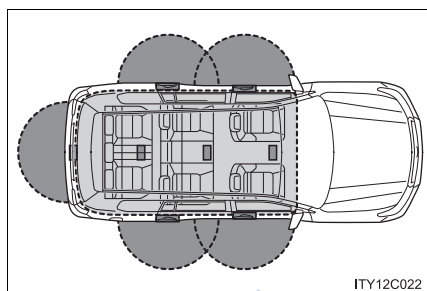

- When locking or unlocking the doors

The system can be operated when the electronic key is within about 2.3 ft. (0.7 m) of an outside door handle.

- When starting the engine or changing “ENGINE START STOP” switch modes

The system can be operated when the electronic key is inside the vehicle.

1

Before driving

تلفن شبانه روزی: ۰۲۱-۸۸۸۶۲۰۸۵

FarmaSOS.com

1-2. Opening, closing and locking the doors

■ Operation signals

A buzzer sounds and the emergency flashers flash to indicate that the doors have been locked/unlocked. (Locked: Once; Unlocked: Twice)

■ Conditions affecting operation

The smart key system uses weak radio waves. In the following situations, the communication between the electronic key and the vehicle may be affected, preventing the smart key system and wireless remote control from operating properly. (Ways of coping →P. 653)



- When the electronic key battery is depleted
- Near a TV tower, electric power plant, gas station, radio station, large display, airport or other facility that generates strong radio waves or electrical noise
- When carrying a portable radio, cellular phone, cordless phone or other wireless communication devices
- When the electronic key has come into contact with, or is covered by a metallic object
- When multiple electronic keys are in the vicinity
- When carrying or using the electronic key together with the following devices that emit radio waves
 - Another vehicle's electronic key
 - A wireless key that emits radio waves
 - Personal computer
- If window tint with a metallic content or metallic objects are attached to the rear window

1-2. Opening, closing and locking the doors



■ Switching the door unlock function

It is possible to set which doors the entry function unlocks.

STEP 1 Turn the “ENGINE START STOP” switch OFF.

STEP 2 When the indicator on the key surface is turned off, press and hold  or  for approximately 5 seconds while pressing  on the key.

The setting changes each time an operation is performed, as shown below. (When changing the setting continuously, release the buttons, wait for at least 5 seconds, and repeat **STEP 2**.)

Multi-information display	Unlocking function	Beep
	Hold the driver's door handle to unlock only the driver's door.	Exterior: Beeps three times Interior: Pings once
	Hold either door handle to unlock all doors.	Exterior: Beeps twice Interior: Pings once

To prevent unintended triggering of the alarm, unlock the doors using the wireless remote control and open and close a door once after the setting have been changed. (If a door is not opened within 60 seconds after  is pressed, the doors will be locked again and the alarm will automatically be set.)

In case that the alarm is triggered, immediately stop the alarm. (→P. 107)

1

Before driving

1-2. Opening, closing and locking the doors

■ Battery-saving function

In the following circumstances, the entry function is disabled in order to prevent the vehicle and electronic key batteries from discharging.

- When the entry function has not been used for 2 weeks or more
- When the electronic key has been left within approximately 3 ft. (1 m) of the vehicle for 10 minutes or more

The system will resume operation when...

- The vehicle is locked using the door handle lock switch.
- The vehicle is locked/unlocked using the wireless remote control function (→P. 44) or the mechanical key. (→P. 653)

■ Electronic key battery depletion

- The standard battery life is 1 to 2 years. (The battery becomes depleted even if the electronic key is not used.) If the smart key system or the wireless remote control function does not operate, or the detection area becomes smaller, the battery may be depleted. Replace the battery when necessary. (→P. 563)
- If the battery becomes low, an alarm will sound in the cabin when the engine stops. (→P. 40)
- To avoid serious deterioration, do not leave the electronic key within 3 ft. (1 m) of the following electrical appliances that produce a magnetic field.
 - TVs
 - Personal computers
 - Recharging cellular phones or cordless phones
 - Table lamps

■ To operate the system properly

Make sure to carry the electronic key when operating the system. Do not get the electronic key too close to the vehicle when operating the system from the outside of the vehicle.

Depending on the position and holding condition of the electronic key, the key may not be detected correctly and the system may not operate properly. (The alarm may go off accidentally, or the door lock prevention may not function.)

■ **Note for the smart key system**

- Even when the electronic key is within the effective range (detection areas), the system may not operate properly in the following cases:
 - The electronic key is too close to the window or outside door handle, near the ground, or in a high place when the doors are locked or unlocked.
 - The electronic key is near the ground or in a high place, or too close to the rear bumper center when the back door is locked or unlocked.
 - The electronic key is on the instrument panel, floor or in the glove box when the engine is started or “ENGINE START STOP” switch modes are changed.
- Do not leave the electronic key on top of the instrument panel or near the door pockets when exiting the vehicle. Depending on the radio wave reception conditions, it may be detected by the antenna outside the cabin and the door will become lockable from the outside, possibly trapping the electronic key inside the vehicle.
- As long as the electronic key is within the effective range, the doors may be locked or unlocked by anyone.
- Even if the electronic key is not inside the vehicle, it may be possible to start the engine if the electronic key is near the window.
- The doors may unlock if a large amount of water splashes on the door handle, such as in the rain or in a car wash. (The doors will automatically be locked after approximately 60 seconds if the doors are not opened and closed.)
- Gripping the door handle when wearing a glove may not unlock the door.
- If the wireless remote control is used to lock the doors when the electronic key is near the vehicle, there is a possibility that the door may not be unlocked by the smart key system. (Use the wireless remote control to unlock the doors.)
- A sudden approach to the effective range or door handle operation may prevent the doors from being unlocked. In this case, return the door handle to the original position and check that the doors unlock before pulling the door handle.

■ **When the vehicle is not driven for extended periods**

To prevent theft of the vehicle, do not leave the electronic key within 6 ft. (2 m) of the vehicle.

1-2. Opening, closing and locking the doors

■ Security feature

If a door is not opened within approximately 60 seconds after the vehicle is unlocked, the security feature automatically locks the vehicle again.

■ Alarms and warning indicators

A combination of exterior and interior alarms as well as warnings displayed on the multi-information display are used to prevent theft of the vehicle and unforeseeable accidents resulting from erroneous operation. Perform the appropriate correction procedure described in the following table.

Alarm	Situation	Correction procedure
Exterior alarm sounds once for 2 seconds	An attempt was made to lock the doors using the entry function while the electronic key was still inside the passenger compartment	Retrieve the electronic key from the passenger compartment and lock the doors again
Exterior alarm sounds once for 60 seconds	An attempt was made to exit the vehicle and lock the doors without first turning the "ENGINE START STOP" switch OFF	Turn the "ENGINE START STOP" switch OFF and lock the doors again
Exterior alarm sounds once for 5 seconds	An attempt was made to lock the vehicle while a door is open	Close all of the doors and lock the doors again
Interior alarm pings continuously	The "ENGINE START STOP" switch was turned to ACCESSORY mode while the driver's door was open (or the driver's door was opened while the "ENGINE START STOP" switch was in ACCESSORY mode)	Turn the "ENGINE START STOP" switch OFF and close the driver's door
	The "ENGINE START STOP" switch was turned OFF while the driver's door was open	Close the driver's door

1-2. Opening, closing and locking the doors

Alarm	Situation	Correction procedure
Interior alarm sounds continuously*1	When the "ENGINE START STOP" switch is in IGNITION ON or ACCESSORY mode, an attempt was made to open the door and exit the vehicle, and the shift lever was not in "P"	Shift the shift lever to "P" and turn the "ENGINE START STOP" switch OFF
Interior and exterior alarms sound continuously*1	When the "ENGINE START STOP" switch is in IGNITION ON or ACCESSORY mode, the driver's door was closed after the key was carried outside the vehicle, and the shift lever not in "P"	Shift the shift lever to "P", turn the "ENGINE START STOP" switch OFF and close the driver's door again
Interior alarm pings once*1	The electronic key has a low battery	Replace the electronic key battery
	An attempt was made to start the engine without the electronic key being present, or the electronic key was not functioning normally	Start the engine with the electronic key present*2

1

Before driving

1-2. Opening, closing and locking the doors

Alarm	Situation	Correction procedure
Interior alarm pings once and exterior alarm sounds 3 times*1	The driver's door was closed after the key was carried outside the vehicle, and the "ENGINE START STOP" switch was not turned OFF	Turn the "ENGINE START STOP" switch OFF and close the driver's door again
	An occupant carried the electronic key outside the vehicle and closed the door while the "ENGINE START STOP" switch was not OFF	Bring the electronic key back into the vehicle

*1: A message will be shown on the multi-information display in the instrument cluster.

*2: If the engine does not start when the electronic key is inside the vehicle, the electronic key battery may be depleted or there may be difficulties receiving signal from the key. (→P. 653)

■ If the smart key system does not operate properly

- Locking and unlocking the doors: Use the mechanical key. (→P. 653)
- Starting the engine (→P. 166)

■ When the electronic key battery is fully depleted

→P. 563

■ Customization

Settings (e.g. smart key system) can be changed.
(Customizable features →P. 694)

■ **Certification for the smart key system**

FCC ID:NI4TMLF-5

NOTE:

This device complies with part 15 of the FCC Rules. Operation is subject to the following two conditions: (1) This device may not cause harmful interference, and (2) this device must accept any interference received, including interference that may cause undesired operation.

FCC WARNING:

Changes or modifications not expressly approved by the party responsible for compliance could void the user's authority to operate the equipment.

1

Before driving

⚠ CAUTION

■ **Caution regarding interference with electronic devices**

- People with implantable cardiac pacemakers, cardiac resynchronization therapy-pacemakers or implantable cardioverter defibrillators should keep away from the smart key system antennas. (→P. 34) The radio waves may affect the operation of such devices. If necessary, the entry function can be disabled. Ask your Toyota dealer for details, such as the frequency of radio waves and timing of the emitted radio waves. Then, consult your doctor to see if you should disable the entry function.
- Users of any electrical medical device other than implantable cardiac pacemakers, cardiac resynchronization therapy-pacemakers or implantable cardioverter defibrillators should consult the manufacturer of the device for information about its operation under the influence of radio waves. Radio waves could have unexpected effects on the operation of such medical devices.

Ask your Toyota dealer for details for disabling the smart key system.

1-2. Opening, closing and locking the doors Wireless remote control

The wireless remote control can be used to lock and unlock the vehicle from outside the vehicle.

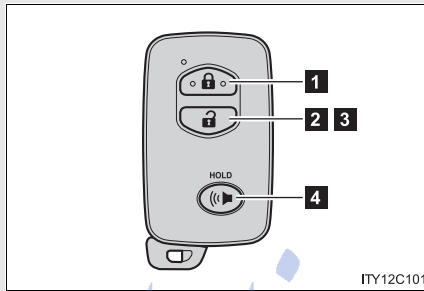

1 Locks all doors

2 Unlocks all doors

Pressing the button unlocks the driver's door. Pressing the button again within 3 seconds unlocks the other doors.

3 Opens the windows and moon roof (press and hold)*

4 Sounds alarm (press and hold) (→P. 107)

*: This setting must be customized at your Toyota dealer.

■ Operation signals

- Doors: A buzzer sounds and the emergency flashers flash to indicate that the doors have been locked/unlocked. (Locked: Once; Unlocked: Twice)
- Windows and moon roof: A buzzer sounds when the windows and moon roof begin to open.

■ Operating conditions

The wireless remote control will not operate when the "ENGINE START STOP" switch is in any position other than OFF.

■ Door lock buzzer

If a door is not fully closed, a buzzer sounds continuously for 5 seconds if an attempt to lock the door is made. Fully close the door to stop the buzzer, and lock the vehicle once more.

■ Security feature

→P. 40

■ **Alarm**

Using the wireless remote control to lock the door will set the alarm system.
(→P. 107)

■ **Electronic key battery depletion**

→P. 653

■ **If the wireless remote control does not operate properly**

- Locking and unlocking the doors: Use the mechanical key. (→P. 653)
- Starting the engine (→P. 166)

■ **When the electronic key battery is fully depleted**

→P. 563

■ **Conditions affecting operation**

→P. 36

■ **Customization**

Settings (e.g. 2-step unlocking function) can be changed.
(Customizable features →P. 694)

■ **Certification for wireless remote control**

FCC ID: HYQ14AEM
FCC ID: HYQ13BZS
FCC ID: HYQ14ABK*
FCC ID: HYQ13CZA*

*: For U.S. mainland only

NOTE:

This device complies with part 15 of the FCC Rules. Operation is subject to the following two conditions: (1) This device may not cause harmful interference, and (2) this device must accept any interference received, including interference that may cause undesired operation.

FCC WARNING:

Changes or modifications not expressly approved by the party responsible for compliance could void the user's authority to operate the equipment.

1-2. Opening, closing and locking the doors Side doors

The vehicle can be locked and unlocked using the smart key system, wireless remote control or door lock switch.

■ Entry function

→P. 32

■ Wireless remote control

→P. 44

■ Door lock switch

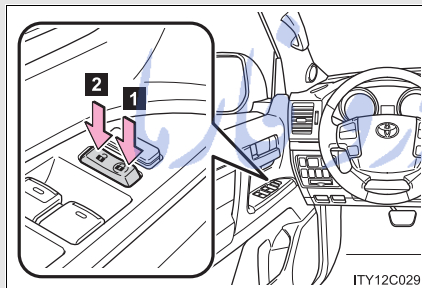

- 1 Locks all doors
- 2 Unlocks all doors

■ Inside lock button

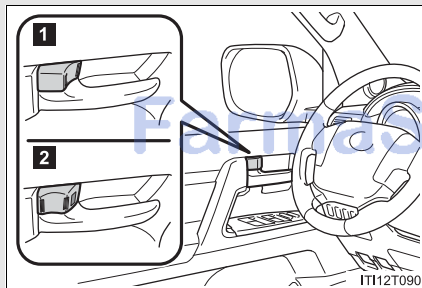

- 1 Locks the door
- 2 Unlocks the door

The front doors can be opened by pulling the inside handles even if the lock buttons are in the lock position.

Locking the driver's door from the outside without a key

STEP 1 Move the inside lock button to the lock position.

STEP 2 Close the door.

The door cannot be locked if the "ENGINE START STOP" switch is in ACCESSORY or IGNITION ON mode, or the electronic key is left inside the vehicle.

Depending on the position of the electronic key, the key may not be detected correctly and the door may be locked.

1

Before driving

Rear door child-protector lock

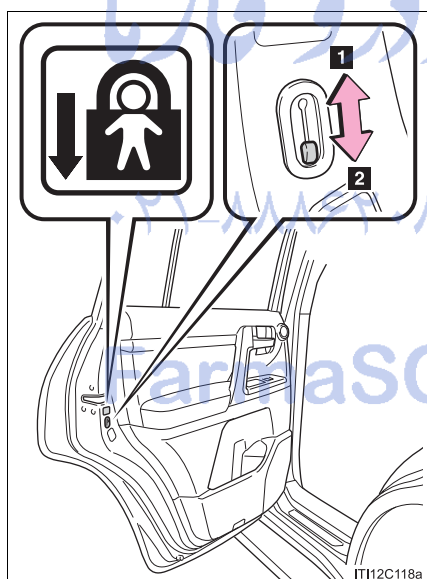

The door cannot be opened from inside the vehicle when the locks are set.

1 Unlock

2 Lock

These locks can be set to prevent children from opening the rear doors. Press down rear door switches to lock the rear doors.

1-2. Opening, closing and locking the doors

Automatic door locking and unlocking systems

The following functions can be set or canceled:



Function	Operation
Shift position linked door locking function	Shifting the shift lever out of "P" locks all doors.
Shift position linked door unlocking function	Shifting the shift lever to "P" unlocks all doors.
Speed linked door locking function	All doors are locked when the vehicle speed is approximately 12 mph (20 km/h) or higher.
Driver's door linked door unlocking function	All doors are unlocked when the driver's door is opened within 45 seconds after turning the "ENGINE START STOP" switch OFF.

■ Setting and canceling the functions

To switch between setting and canceling, follow the procedure below:

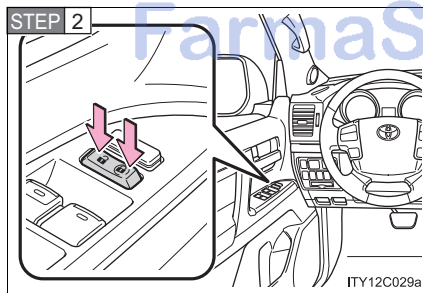
STEP 1 Close all the doors and turn the "ENGINE START STOP" switch to IGNITION ON mode. (Perform step 2 within 20 seconds.)







Shift the shift lever to "P" or "N", press and hold the driver's door lock switch ( or ) for 5 seconds then release.

The shift lever and switch positions corresponding to the desired function to be set are shown as follows.

Use the same procedure to cancel the function.

1-2. Opening, closing and locking the doors

Function	Shift lever position	Driver's door lock switch position
Shift position linked door locking function	"P"	
Shift position linked door unlocking function		
Speed linked door locking function	"N"	
Driver's door linked door unlocking function		

1

Before driving

When the setting or canceling operation is complete, all doors are locked and then unlocked.

■ Impact detection door lock release system

In the event that the vehicle is subject to a strong impact, all the doors are unlocked.

Depending on the force of the impact or the type of accident, however, the system may not operate.

■ Using the mechanical key

The doors can also be locked and unlocked with the mechanical key.
(→P. 653)

■ Customization

Settings (e.g. unlocking function using a key) can be changed.
(Customizable features →P. 694)

1-2. Opening, closing and locking the doors

CAUTION

■ To prevent an accident

Observe the following precautions while driving the vehicle.

Failing to do so may result in a door opening and an occupant falling out, resulting in death or serious injury.

- Always use a seat belt.
- Always lock all doors.
- Ensure that all doors are properly closed.
- Do not pull the inside handle of the doors while driving.
The doors may be opened and the passengers are thrown out of the vehicle and it may result in serious injury or death.
Be especially careful of the front doors, as the doors may be opened even if the inside lock buttons are in locked position.
- Set the rear door child-protector locks when children are seated in the rear seat.

تلفن شبانه روزی: ۰۲۱-۸۸۸۶۲۰۸۵

FarmaSOS.com

1-2. Opening, closing and locking the doors Back door

The back door can be locked/unlocked and opened by the following procedures.

■ Locking and unlocking the back door

- ▶ Door lock switch
→P. 46
- ▶ Entry function
→P. 32
- ▶ Wireless remote control
→P. 44

■ Opening the back door from outside the vehicle

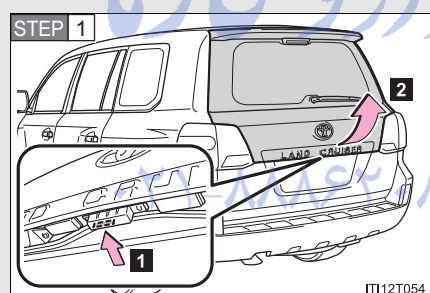

- 1 Unlock the back door
- 2 Raise the back door

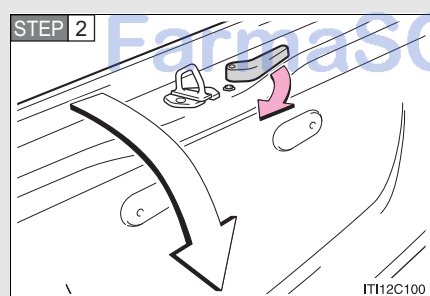

Pull the handle

1

Before driving

1-2. Opening, closing and locking the doors

When closing the back door

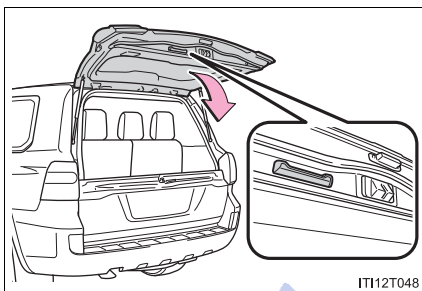

- Make sure that the lower side of the back door is closed before closing the upper side of the back door.
- Lower the back door using the back door handle, and make sure to push the back door down from the outside to close it.

Rear step bumper

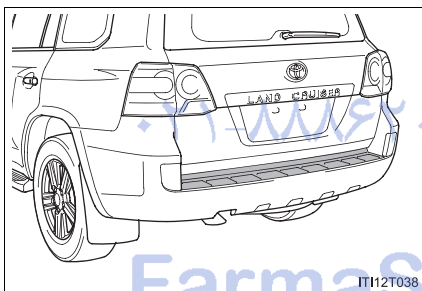

The rear step bumper is for rear end protection and easier step-up loading.

1-2. Opening, closing and locking the doors

■ If the back door opener is inoperative

The back door can be operated from the inside.

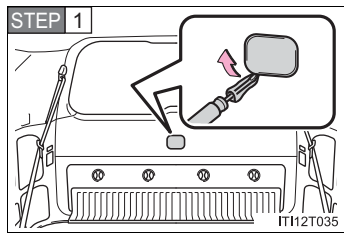

Remove the cover on the back door trim.
Use a cloth to prevent scratches.

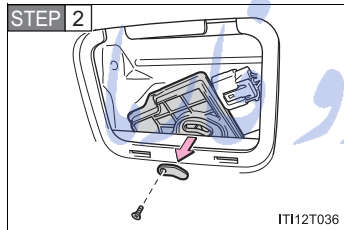

Remove the screw and cover.

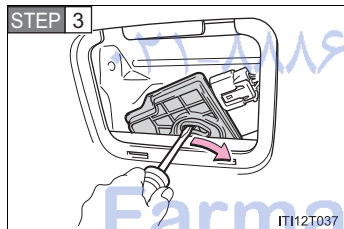

Push the lever for the back door motor,
open the back door.

1

Before driving

1-2. Opening, closing and locking the doors

CAUTION

■ While driving

- Keep the back door closed while driving.
If the back door is left open, it may hit near-by objects while driving or luggage may be unexpectedly thrown out, causing an accident.
In addition, exhaust gases may enter the vehicle, causing death or a serious health hazard. Make sure to close the back door before driving.
- Before driving the vehicle, make sure that the back door is fully closed. If the back door is not fully closed, it may open unexpectedly while driving, causing an accident.
- Never let anyone sit in the luggage compartment. In the event of sudden braking or an accident, they are susceptible to death or serious injury.

■ When children are in the vehicle

Observe the following precautions.

Failure to do so may result in death or serious injury.

- Do not allow children to play in the luggage compartment.
If a child is accidentally locked in the luggage compartment, they could have heat exhaustion or other injuries.
- Do not allow a child to open or close the back door.
Doing so may cause the back door to move unexpectedly, or cause the child's hands, head, or neck to be caught by the closing back door.

⚠ CAUTION**■ Operating the back door**

Observe the following precautions.

Failure to do so may cause parts of the body to be caught, resulting in death or serious injury.

- Remove any heavy loads, such as snow and ice, from the back door before opening it. Failure to do so may cause the back door suddenly shut again after it is opened.
- When opening or closing the back door, thoroughly check to make sure the surrounding area is safe.
- If anyone is in the vicinity, make sure they are safe and let them know that the back door is about to open or close.
- Use caution when opening or closing the back door in windy weather as it may move abruptly in strong wind.

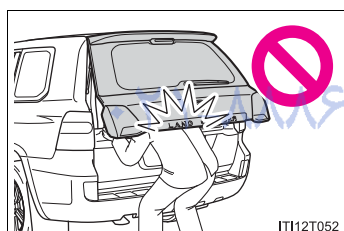

- The back door may suddenly shut if it is not opened fully. It is more difficult to open or close the back door on an incline than on a level surface, so beware of the back door unexpectedly opening or closing by itself. Make sure that the back door is fully open and secure before using the luggage compartment.



- When closing the back door, take extra care to prevent your fingers etc. from being caught.
- When closing the back door, make sure to press it lightly on its outer surface. If the back door handle is used to fully close the back door, it may result in hands or arms being caught.

1-2. Opening, closing and locking the doors

⚠ CAUTION

- Do not pull on the back door damper stay to close the back door, and do not hang on the back door damper stay. Doing so may cause hands to be caught or the back door damper stay to break, causing an accident.
- If a bicycle carrier or similar heavy object is attached to the back door, it may suddenly shut again after being opened, causing someone's hands, head or neck to be caught and injured. When installing an accessory part to the back door, using a genuine Toyota part is recommended.

⚠ NOTICE

■ Back door damper stays

The back door is equipped with damper stays that hold the back door in place.

Observe the following precautions.

Failure to do so may cause damage to the back door damper stay, resulting in malfunction.

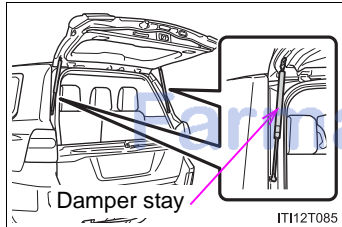

- Do not attach any foreign objects, such as stickers, plastic sheets, or adhesives to the damper stay rod.
- Do not touch the damper stay rod with gloves or other fabric items.
- Do not attach any accessories other than genuine Toyota parts to the back door.
- Do not place your hand on the damper stay or apply lateral forces to it.

1-3. Adjustable components (seats, mirrors, steering wheel) Front seats

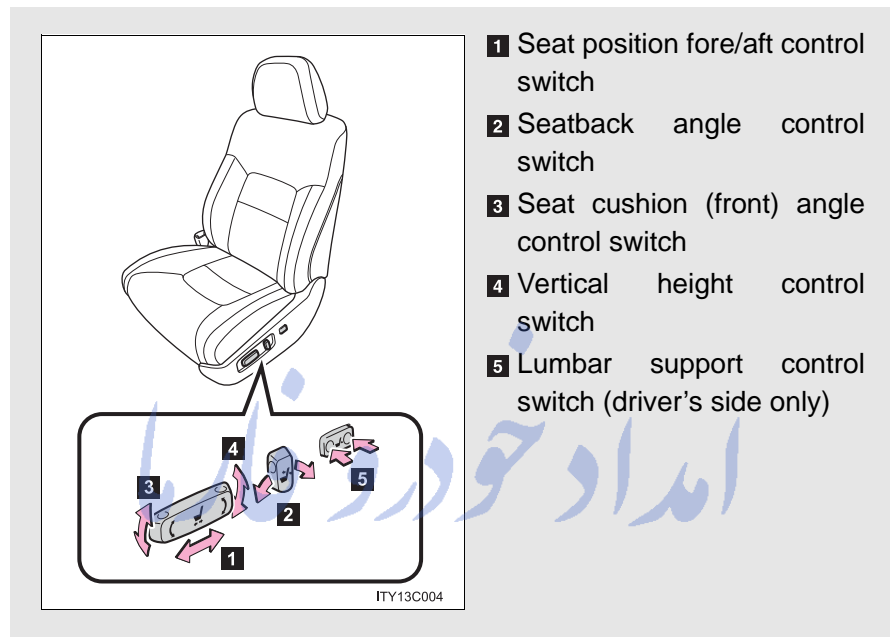

1

Before driving

Active head restraint

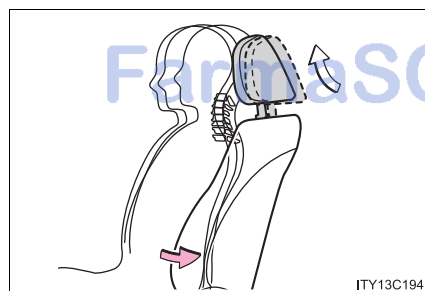

When the occupant's lower back presses against the seatback during a rear-end collision, the head restraint moves slightly forward and upward to help reduce the risk of whiplash on the seat occupant.

1-3. Adjustable components (seats, mirrors, steering wheel)

■ Active head restraint

Even small forces applied to the seatback may cause the head restraint to move. Pushing up a locked head restraint forcibly may make the inner structure of the head restraint appear. This does not indicate a problem.

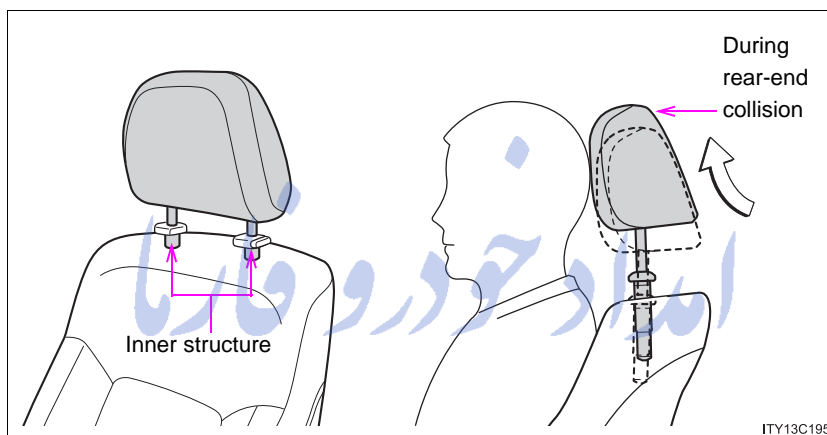

⚠ CAUTION

■ Seat adjustment

- Be careful that the seat does not hit passengers or luggage.
- Do not recline the seat more than necessary when the vehicle is in motion to reduce the risk of sliding under the lap belt.
If the seat is too reclined, during an accident the lap belt may slide past the hips and apply restraint forces directly to the abdomen or your neck may contact the shoulder belt, increasing the risk of death or serious injury. Adjustments should not be made while driving as the seat may unexpectedly move and cause the driver to lose control of the vehicle.

1-3. Adjustable components (seats, mirrors, steering wheel)
Rear seats

► Second seat

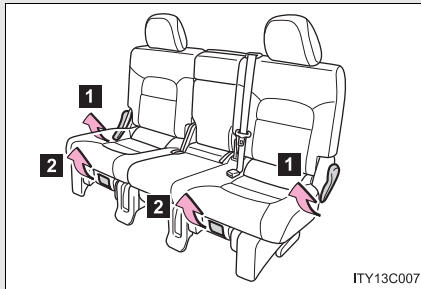

- 1** Seatback angle adjustment lever
- 2** Seat position adjustment lever

► Third seat

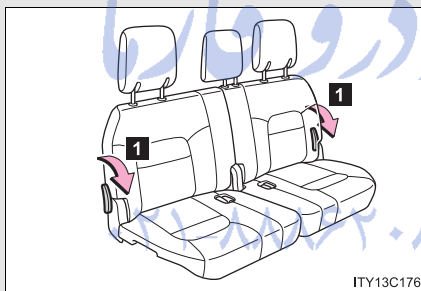

1
Before driving

FarmaSOS.com

1-3. Adjustable components (seats, mirrors, steering wheel)

Tumbling the second seats and third seat entry

For easy access to the third seat, perform **STEP 1** in “Tumbling the second seats”. (→P. 61)

■ **Before tumbling the second seats**

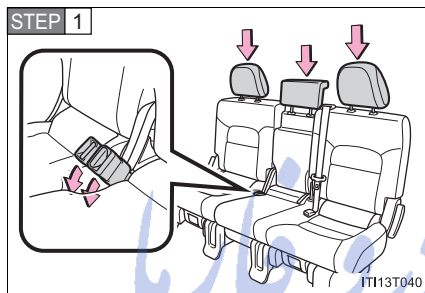

Stow the seat belt buckles and lower the head restraints to the lowest position.

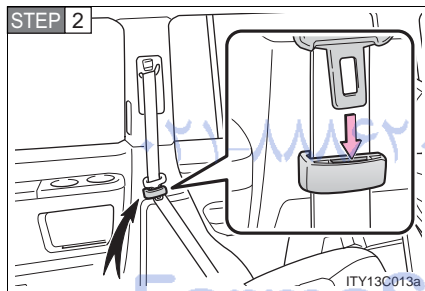

Pass the outer seat belts through the seat belt hangers and secure the seat belt plates.

This prevents the shoulder belt from being damaged.

Make sure that the seat belts are removed from the hangers before using them.

1-3. Adjustable components (seats, mirrors, steering wheel)

■ **Tumbling the second seats**

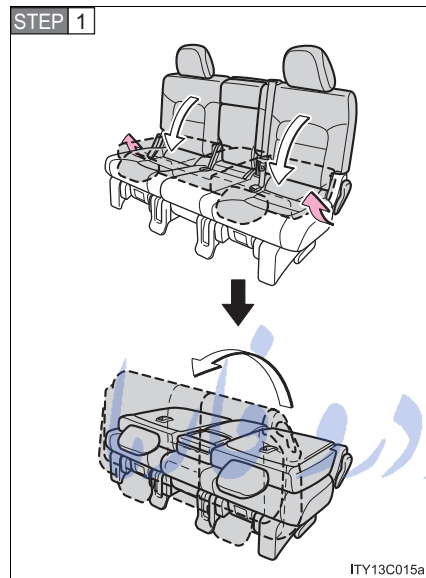

Fold down the seatback while pulling the seatback angle adjustment lever, and swing the whole seat up and forward.

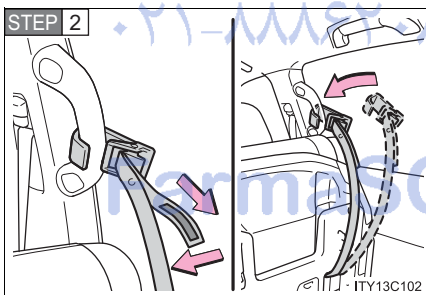

Hook the holding strap to the assist grip and secure the seat by pulling its free end.

When returning the second seat to its original position, stow the holding strap.

1

Before driving

1-3. Adjustable components (seats, mirrors, steering wheel)

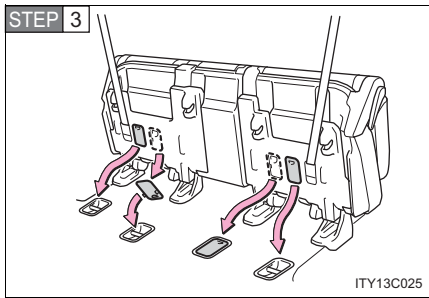

Remove the seat hook covers from the back of the seat cushion, and install them on the seat hooks.

When returning the second seat to its original position, remove the seat hook covers from the floor and install them in the back of the seat cushion.

■ If you cannot raise the left side seatback

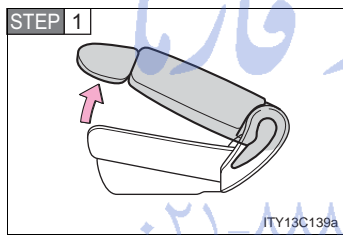

Lift the seatback until it stops.

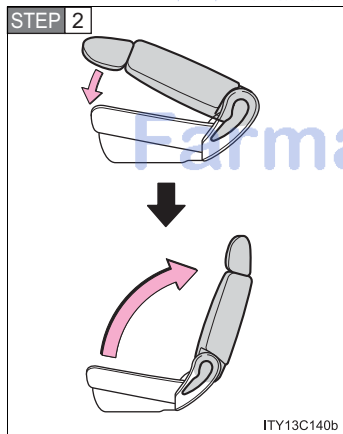

Lower the seatback a little then lift it again.

Folding up the third seats

■ Before folding up the third seats

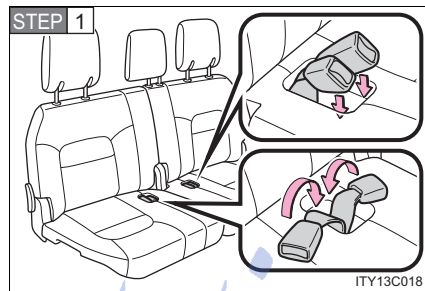

Stow the seat belts buckles.

STEP 2 Stow the center head restraint in the seatback. (→P. 75)

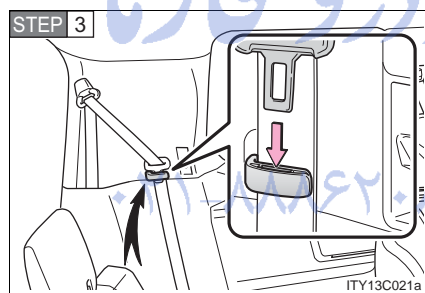

Pass the outer seat belts through the seat belt hangers and secure the seat belt plates.

This prevents the shoulder belt from being damage.

Make sure that the seat belts are removed from the hangers before using them.

STEP 4 Stow the center seat belt tabs in the cover set in the roof. (→P. 78)

1

Before driving

1-3. Adjustable components (seats, mirrors, steering wheel)

■ Folding up the third seats

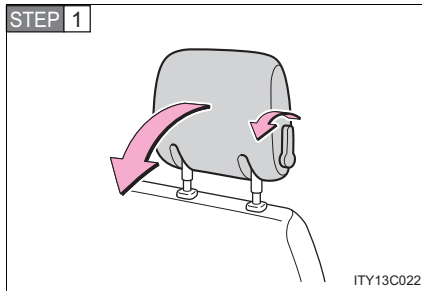

Fold down the head restraints while pulling the head restraint angle lever.

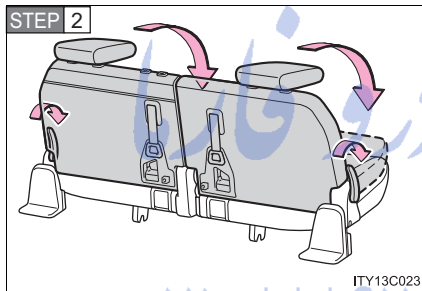

Push the seatback angle levers and fold the third seatbacks.

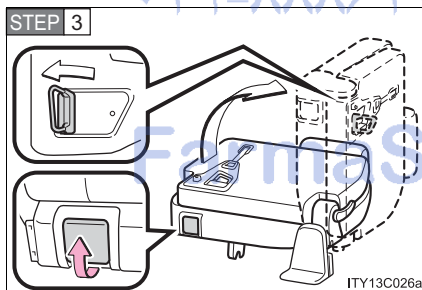

Pull the seat leg lock release levers.

The seat will rise, and the seatback striker will also automatically sit up.

Before raising, make sure that the handle on the rear of the seatback is secure.

1-3. Adjustable components (seats, mirrors, steering wheel)

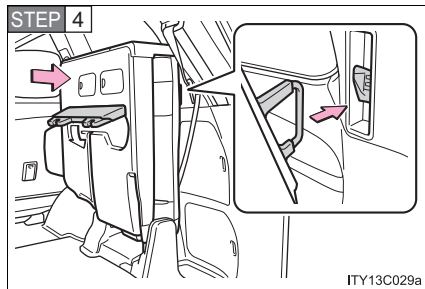

Secure the seats by the strikers.

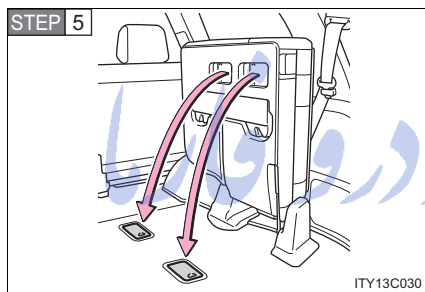

Remove the seat hook covers from the back of the seat cushion, and install them on the seat hooks.

■ Returning the third seats

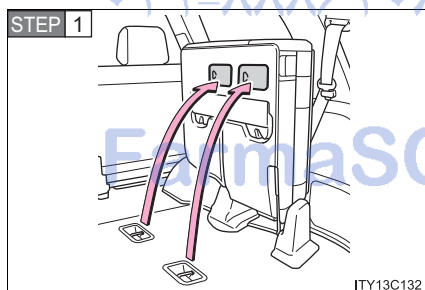

Remove the seat hook covers from the floor and install them into the back of the seat cushion.

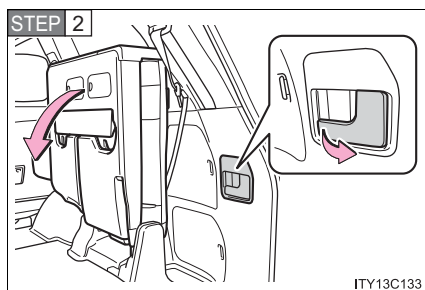

Unlock the seats by pulling the stowed seat lock release levers and lower the seats to its original position.

1

Before driving

1-3. Adjustable components (seats, mirrors, steering wheel)

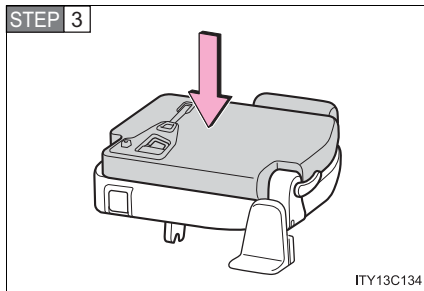

Secure the seats by the strikers.

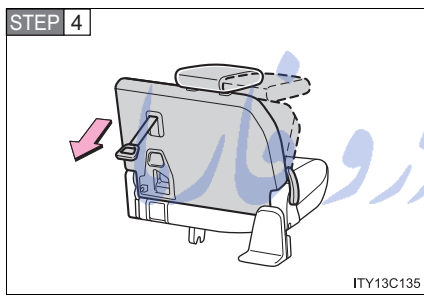

Pull the handle and raise the seatbacks.

Fix the handle securely in its original position after use.

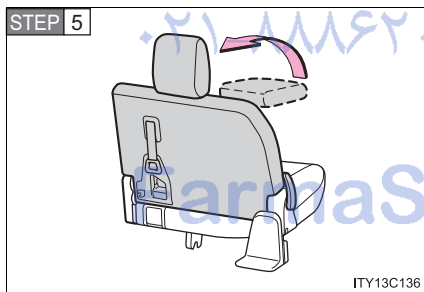

Raise the head restraints.

1-3. Adjustable components (seats, mirrors, steering wheel)

CAUTION

■ **Seat adjustment**

Do not recline the seat more than necessary when the vehicle is in motion, to reduce the risk of sliding under the lap belt.

If the seat is too reclined, during an accident the lap belt may slide past the hips and apply restraint forces directly to the abdomen or your neck may contact the shoulder belt, increasing the risk of death or serious injury.

■ **When the seatback is folded**

- Do not sit on or place anything on the seatback while driving.
- Be sure to install the seat hook covers on the seat hooks, or you may get burned when they become hot.

■ **When returning the seatbacks to their original position**

Observe the following precautions. Failure to do so may result in death or serious injury.

- Be careful not to get your hands or feet pinched in the seat.
- Make sure the seats are securely locked. Failure to do so will prevent the seat belt from operating properly.
- Check that the seat belts are not twisted or caught under the seat.
- Arrange the seat belts in the proper positions for ready use.

■ **Avoiding damage to seat components**

Do not hang or attach anything on the seatback striker.

NOTICE

■ **Before tumbling, folding up the seats**

The seat belts and buckles must be stowed.

■ **After returning the third seat**

Make sure that the handle on the rear of the seatback has been secured.

1

Before driving

1-3. Adjustable components (seats, mirrors, steering wheel) Driving position memory system

Your preferred driving position (the position of the driver's seat, steering wheel and outside rear view mirrors) can be entered into the computer's memory and recalled with the touch of a button. It is also possible to set this function to activate automatically when the doors are unlocked.

Three different driving positions can be entered into memory.

■ Entering a position to memory

STEP 1 Turn the "ENGINE START STOP" switch to IGNITION ON mode.

STEP 2 Adjust the driver's seat, steering wheel, and outside rear view mirrors to the desired positions.

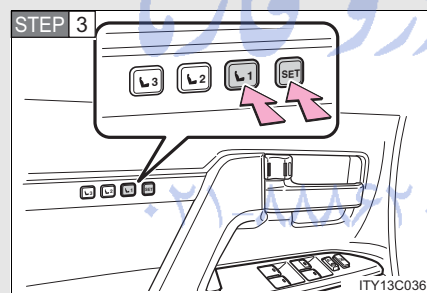

While pressing the "SET" button, or within 3 seconds after the "SET" button is pressed, press and hold button "1", "2" or "3" until the signal beeps.

If the selected button has already been preset, the previously recorded position will be overwritten.

FarmaSOS.com

1-3. Adjustable components (seats, mirrors, steering wheel)

■ Recalling the memorized position

Check that the shift lever is set in "P".

STEP 1 Turn the "ENGINE START STOP" switch to IGNITION ON mode.

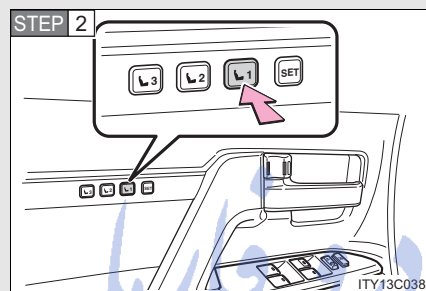

Press button "1", "2" or "3" to recall the desired position.

1

Before driving

Linking driving position memory with door unlock operation

Record your driving position to button "1", "2" or "3" before performing the following:

► Using the wireless remote control

STEP 1 Turn the "ENGINE START STOP" switch to OFF after closing the driver's door.

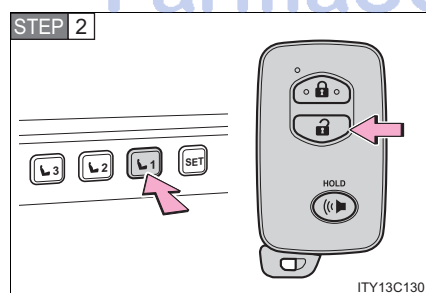

While pressing the desired button ("1", "2" or "3"), press  on the wireless remote control until the signal beeps.

The driving position is recalled when the driver's door is unlocked using the entry function or wireless remote control and the driver's door is opened.

1-3. Adjustable components (seats, mirrors, steering wheel)

To prevent unintended triggering of the alarm, open and close a door once after a driving position has been recorded. (If a door is not opened within 60 seconds after  is pressed, the doors will be locked again and the alarm will automatically be set.)

In case that the alarm is triggered, immediately stop the alarm.

(→P. 107)

► Using the door lock switch

Carry only the key to which you want to link the driving position. If 2 or more keys are in the vehicle, the driving position cannot be linked properly.

STEP 1 Turn the “ENGINE START STOP” switch to OFF after closing the driver’s door.

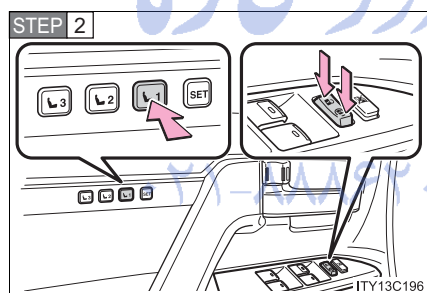

While pressing the desired button (“1”, “2”, or “3”), press the lock or unlock side on the door lock switch until the signal beeps.

The driving position is recalled when the driver’s door is unlocked using the entry function or wireless remote control and the driver’s door is opened.

■ Canceling the linked door unlock operation

STEP 1 Turn the “ENGINE START STOP” switch to OFF after closing the driver’s door.

STEP 2 Using the wireless remote control: While pressing “SET” button, press  button on the wireless remote control until the signal beeps.

Using the door lock switch: While pressing “SET” button, press the lock or unlock side on the door lock switch until the signal beeps.

■ Retained accessory power

- Each memorized position (except for the steering wheel position) can be activated within 3 minutes after the driver’s door is opened, even if the “ENGINE START STOP” switch is turned off.
- Each memorized position (except for the steering wheel position) can be activated within 60 seconds after the driver’s door is closed, even if the “ENGINE START STOP” switch is turned off.

■ To cancel seat position recall

Perform any one of the following operations.

- Press the “SET” button
- Press button “1”, “2” or “3”.
- Adjust the seat using the switches (only cancels seat position recall)
- Adjust the steering wheel using the tilt and telescopic steering control switch (only cancels steering wheel position recall)

■ If the battery is disconnected

The memorized positions must be reset because the computer’s memory is erased when the battery is disconnected.

CAUTION

■ Seat adjustment caution

Take care during seat adjustment that the seat does not strike the rear passenger or squeeze your body against the steering wheel.

1-3. Adjustable components (seats, mirrors, steering wheel) Head restraints

Head restraints are provided for all seats.

► Front seats

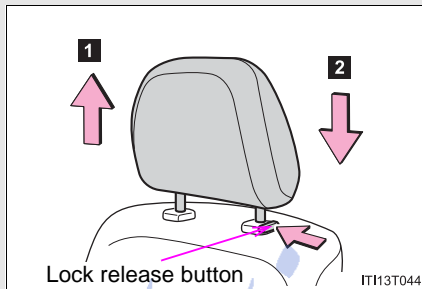

Vertical adjustment

- 1 Up
- 2 Down

Push the head restraint up or down while pressing the lock release button.

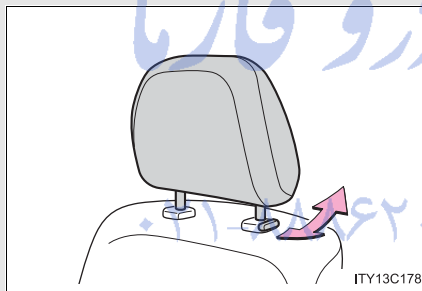

Angle adjustment

► Second seats

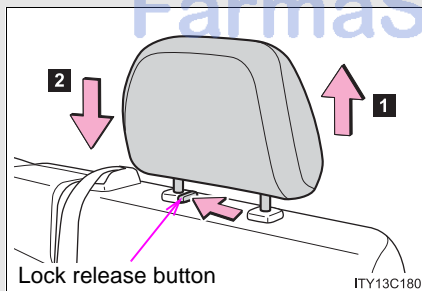

Vertical adjustment

- 1 Up
- 2 Down

Pull the head restraint up.
Press and hold the lock release button when lowering the head restraint.

1-3. Adjustable components (seats, mirrors, steering wheel)

▶ Third outboard seats

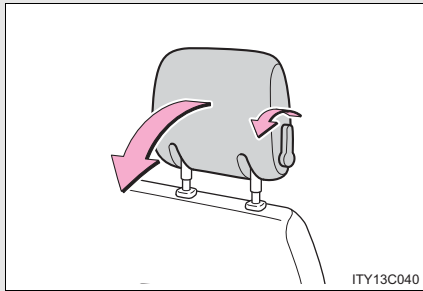

To fold

Pull the head restraint angle lever to fold the head restraint.

1

Before driving

■ Adjusting the height of the head restraints

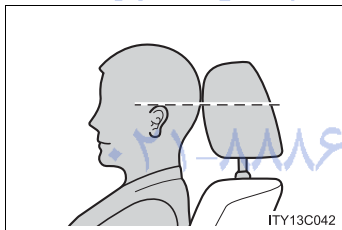

Make sure that the head restraints are adjusted so that the center of the head restraint is closest to the top of your ears.

■ Adjusting the second center seat head restraint

Always raise the head restraint one level from the stowed position when using.

1-3. Adjustable components (seats, mirrors, steering wheel)

■ Removing the head restraints

► Front seats

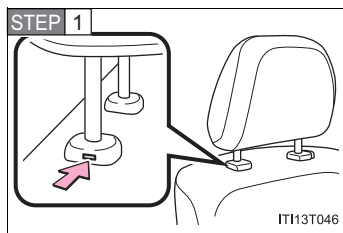

Push a flathead screwdriver into the slot. The slot is located on the right side of the right head restraint anchor.

STEP 2 While pressing in the flathead screwdriver, pull up the head restraint.

► Second seats

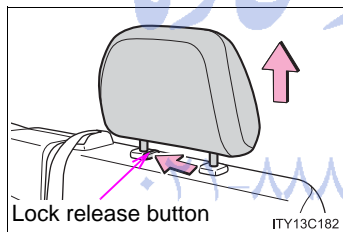

Pull the head restraint up while pressing the lock release button.

► Third center seat

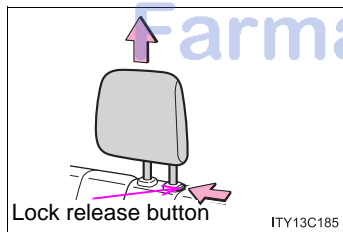

Pull the head restraint up while pressing the lock release button.

1-3. Adjustable components (seats, mirrors, steering wheel)

► Third outboard seats

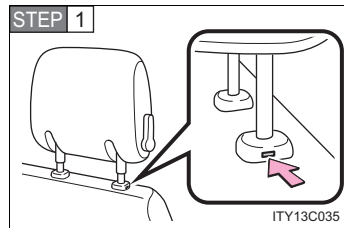

Push a flathead screwdriver into the slot. The slot is located on the left side of the left head restraint anchor.

STEP 2 While pressing in the flathead screwdriver, pull up the head restraint.

■ Installing the head restraints

STEP 1 Align the head restraint with the installation holes.

STEP 2 Push down the head restraint to the lock position.

■ When not using the third center seat head restraint

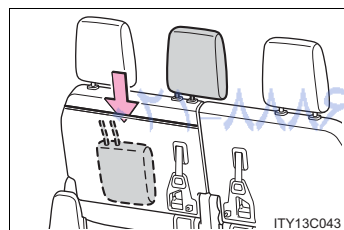

Open the zipper on the back of the third seat and stow the head restraint inside.

⚠ CAUTION

■ Head restraint precautions

Observe the following precautions regarding the head restraints. Failure to do so may result in death or serious injury.

- Use the head restraints designed for each respective seat.
- Adjust the head restraints to the correct position at all times.
- After adjusting the head restraints, push down on them and make sure they are locked in position.
- Do not drive with the head restraints removed.

1

Before driving

1-3. Adjustable components (seats, mirrors, steering wheel) Seat belts

Make sure that all occupants are wearing their seat belts before driving the vehicle.

■ Correct use of the seat belts

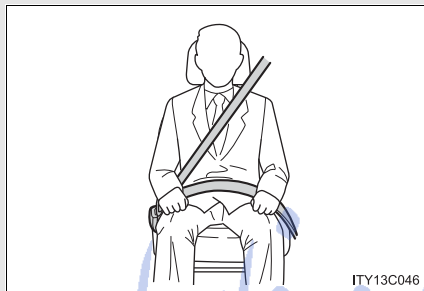

- Extend the shoulder belt so that it comes fully over the shoulder, but does not come into contact with the neck or slide off the shoulder.
- Position the lap belt as low as possible over the hips.
- Adjust the position of the seatback. Sit up straight and well back in the seat.
- Do not twist the seat belt.

■ Fastening and releasing the seat belt

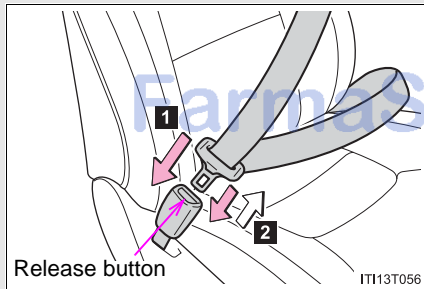

1 Fastening the belt

Push the tab into the buckle until a clicking sound is heard.

2 Releasing the belt

Press the release button.

1-3. Adjustable components (seats, mirrors, steering wheel)

■ Fastening and releasing the third center seat belt

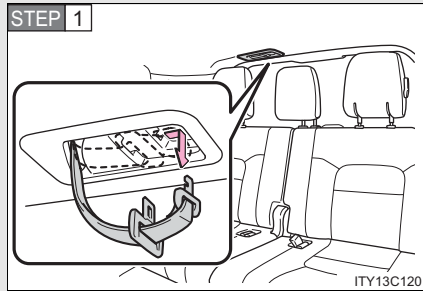

Pull out the tab

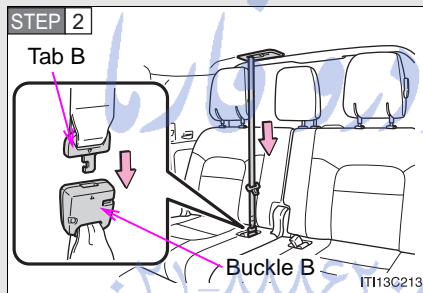

Push tab B into buckle B until a clicking sound is heard

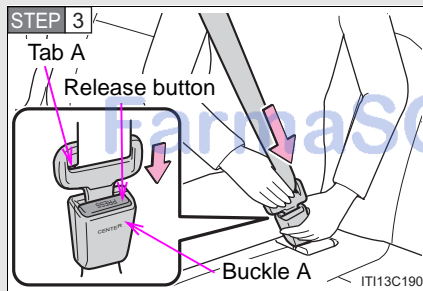

Push tab A into buckle A until a clicking sound is heard

To release, push the release button on buckle A.

1

Before driving

1-3. Adjustable components (seats, mirrors, steering wheel)

■ Releasing and storing the third center seat belt

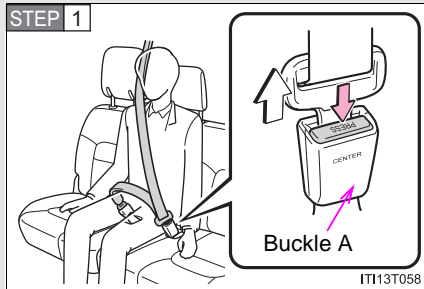

Push the release button on buckle A

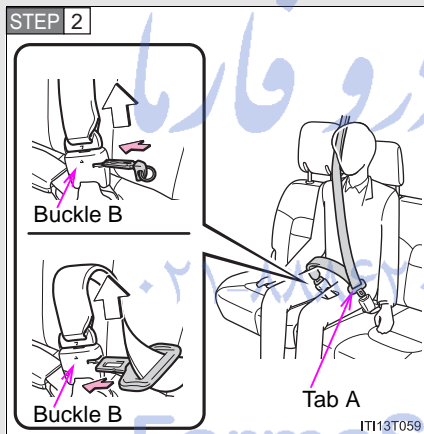

Push either the mechanical key or tab A into buckle B

When releasing and storing the seat belt, hold the belt while winding it back gently

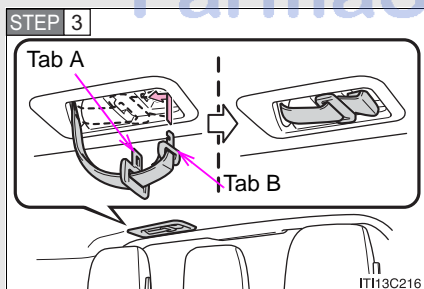

Put tabs A and B together and stow them in the holder

To reattach the seat belt, reverse the above procedure, pulling out the tabs and inserting tab B into buckle B

1-3. Adjustable components (seats, mirrors, steering wheel)

■ Adjusting the height of the belt (front and second outboard seats)

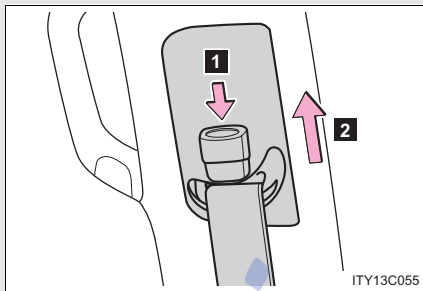

1 Down

2 Up

Move the height adjuster up and down as needed until you hear a click.

1

Before driving

Seat belt pretensioners (front and second outboard seats)

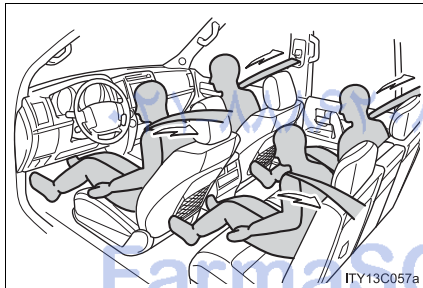

The pretensioner helps the seat belt to quickly restrain the occupant by retracting the seat belt when the vehicle is subjected to certain types of severe frontal collision or a vehicle rollover.

The pretensioner may not activate in the event of a minor frontal impact, a side impact or a rear impact.

Pre-collision seat belts (front seats of vehicles with pre-collision system)

▶ **Brake-linked pre-collision system**

If the system determines that emergency braking is being performed or the vehicle is out of control, the front seat belts will retract. (→P. 289)

▶ **Radar type pre-collision system**

If the system determines that a collision is unavoidable, the front seat belts will retract before the collision. (→P. 289)

■ **Emergency locking retractor (ELR)**

The retractor will lock the belt during a sudden stop or on impact. It may also lock if you lean forward too quickly. A slow, easy motion will allow the belt to extend, and you can move around fully.

■ **Automatic locking retractor (ALR)**

When a passenger's shoulder belt is completely extended and then retracted even slightly, the belt is locked in that position and cannot be extended. This feature is used to hold the child restraint system (CRS) firmly. To free the belt again, fully retract the belt and then pull the belt out once more. (→P. 140)

1-3. Adjustable components (seats, mirrors, steering wheel)

■ When the third center seat belt cannot be extended

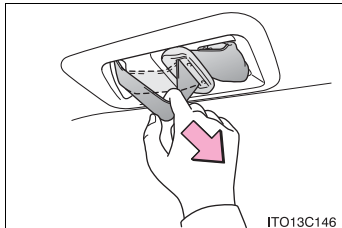

Put your fingers between the seat belt and the holder.

Pull the seat belt forcefully in the direction of the arrow and then release it to unlock.

1

Before driving

■ Child seat belt usage

The seat belts of your vehicle were principally designed for persons of adult size.

- Use a child restraint system appropriately for the child, until the child becomes large enough to properly wear the vehicle's seat belt. (→P. 135)
- When the child becomes large enough to properly wear the vehicle's seat belt, follow the instructions on P. 76 regarding seat belt usage.

■ Replacing the belt after the pretensioner has been activated

If the vehicle is involved in multiple collisions, the pretensioner will activate for the first collision, but will not activate for the second or subsequent collisions.

■ Seat belt extender

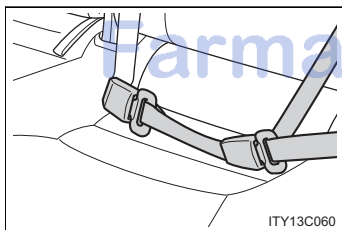

If your seat belts cannot be fastened securely because they are not long enough, a personalized seat belt extender is available from your Toyota dealer free of charge.

⚠ CAUTION

Observe the following precautions to reduce the risk of injury in the event of sudden braking, sudden swerving or an accident. Failing to do so may cause death or serious injury.

■ Wearing a seat belt

- Ensure that all passengers wear a seat belt.
- Always wear a seat belt properly.
- Each seat belt should be used by one person only. Do not use a seat belt for more than one person at the same time, including children.
- Children should be seated in the rear seat and always use a seat belt and/or an appropriate child restraint system.
- Do not recline the seat any more than necessary to achieve a proper seating position. The seat belt is most effective when the occupants are sitting up straight and well back in the seats.
- Do not wear the shoulder belt under your arm.
- Always wear your seat belt low and snug across your hips.

■ Pregnant women

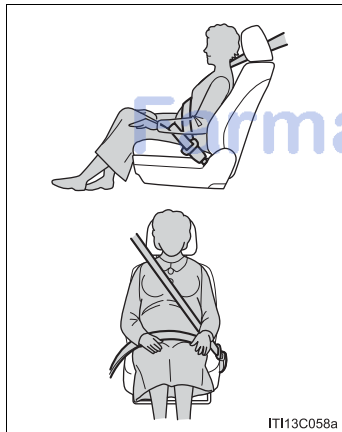

تلفن شبانه روزی: ۰۸۵ ۸۸۶۲ ۸۱-۳۱
Obtain medical advice and wear the seat belt in the proper way. (→P. 76)

Women who are pregnant should position the lap belt as low as possible over the hips in the same manner as other occupants. Extend the shoulder belt completely over the shoulder and position the belt across the chest. Avoid belt contact over the rounding of the abdominal area.

If the seat belt is not worn properly, not only a pregnant woman, but also the fetus could suffer death or serious injury as a result of sudden braking, sudden swerving or a collision.

■ People suffering illness

Obtain medical advice and wear the seat belt in the proper way. (→P. 76)

⚠ CAUTION

■ **When children are in the vehicle**

Do not allow children to play with the seat belt. If the seat belt becomes twisted around a child's neck, it may lead to choking or other serious injuries that could result in death.

If this occurs and the buckle cannot be unfastened, scissors should be used to cut the belt.

■ **Seat belt pretensioners**

● Do not place anything, such as a cushion, on the front passenger's seat. Doing so will disperse the passenger's weight, which prevents the sensor from detecting the passenger's weight properly. As a result, the seat belt pretensioner for the front passenger's seat may not activate in the event of a collision.

● If the pretensioner has activated, the SRS warning light will come on. In that case, the seat belt cannot be used again and must be replaced at your Toyota dealer.

■ **Adjustable shoulder anchor**

Always make sure the shoulder belt is positioned across the center of your shoulder. The belt should be kept away from your neck, but not falling off your shoulder. Failure to do so could reduce the amount of protection in an accident and cause death or serious injuries in the event of a sudden stop, sudden swerve or accident. (→P. 79)

■ **When using the third center seat belt**

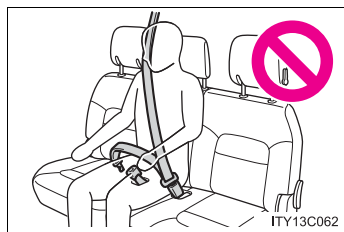

Do not use the third center seat belt with either buckle released. Fastening only one of the buckles may result in death or serious injury in case of sudden braking, sudden swerving or a collision.

 CAUTION

■ **Seat belt damage and wear**

- Do not damage the seat belts by allowing the belt, plate or buckle to be jammed in the door.
- Inspect the seat belt system periodically. Check for cuts, fraying, and loose parts. Do not use a damaged seat belt until it is replaced. Damaged seat belts cannot protect an occupant from death or serious injury.
- Ensure that the belt and tab are locked and the belt is not twisted. If the seat belt does not function correctly, immediately contact your Toyota dealer.
- Replace the seat assembly, including the belts, if your vehicle has been involved in a serious accident, even if there is no obvious damage.
- Do not attempt to install, remove, modify, disassemble or dispose of a seat belt. Have any necessary repairs carried out by your Toyota dealer. Inappropriate handling of the pretensioner may cause it to activate or operate improperly and may cause death or serious injury.

■ **Using a seat belt extender**

- Do not wear the seat belt extender, if you can fasten the seat belt without the extender.
- Do not use the seat belt extender when installing a child restraint system, because the belt will not securely hold the child restraint system, increasing the risk of death or serious injury in the event of a sudden stop, sudden swerve or accident.
- The personalized extender may not be safe on another vehicle, when used by another person, or at a different seating position other than the one originally intended.

1-3. Adjustable components (seats, mirrors, steering wheel)

 NOTICE

■ **When using a seat belt extender**

When releasing the seat belt, press on the buckle release button on the extender, not on the seat belt.

This helps prevent damage to the vehicle interior and the extender itself.

1

Before driving

امداد خودرو فارما

تلفن شبانه روزی: ۰۲۱-۸۸۸۶۲۰۸۵

FarmaSOS.com

1-3. Adjustable components (seats, mirrors, steering wheel) Steering wheel

The steering wheel can be adjusted to a comfortable position while the “ENGINE START STOP” switch is in **ACCESSORY** or **IGNITION ON** mode.

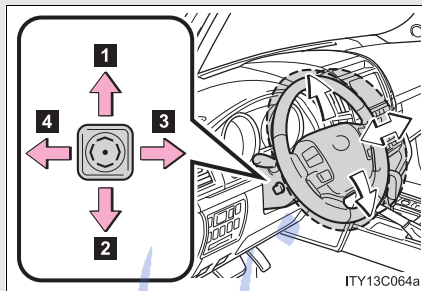

- 1 Up
- 2 Down
- 3 Toward the driver
- 4 Away from the driver

Auto tilt away

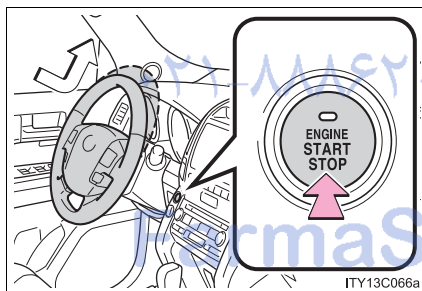

When the “ENGINE START STOP” switch is **OFF**, the steering wheel returns to its stowed position by moving up and away to enable easier driver entry and exit.

Switching to **ACCESSORY** or **IGNITION ON** mode will return the steering wheel to the original position.

■ **One-touch adjustment of the steering position**

A desired steering position can be entered to memory and recalled automatically by the driving position memory. (→P. 68)

 **CAUTION**

■ **While driving**

Do not adjust the steering wheel.
Doing so may cause the driver to mishandle the vehicle and an accident, resulting in death or serious injury.

1

Before driving

امداد خودرو فارما

تلفن شبانه روزی: ۰۲۱-۸۸۸۶۲۰۸۵

FarmaSOS.com

1-3. Adjustable components (seats, mirrors, steering wheel) Inside rear view mirror

The rear view mirror's position can be adjusted to enable sufficient confirmation of the rear view in accordance with the driver's seating posture.

Adjusting the height of the rear view mirror

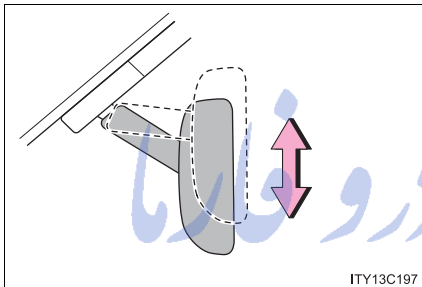

Adjust the height of the rear view mirror by moving it up and down.

Automatic anti-glare function

Responding to the level of brightness of the headlights of vehicles behind, the reflected light is automatically reduced.

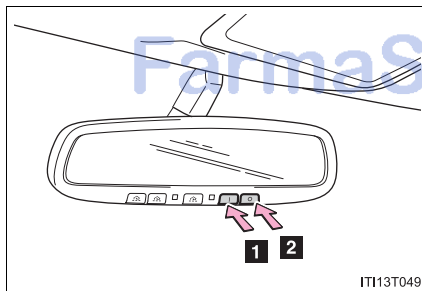

Changing automatic anti-glare function mode ON/OFF

- 1 ON
- 2 OFF

When the automatic anti-glare function is in ON mode, the indicator illuminates.

The function will be set to ON mode each time the "ENGINE START STOP" switch is turned to IGNITION ON mode.

Pressing the button turns the function to OFF mode. (The indicator also turns off.)

1-3. Adjustable components (seats, mirrors, steering wheel)

■ To prevent sensor error

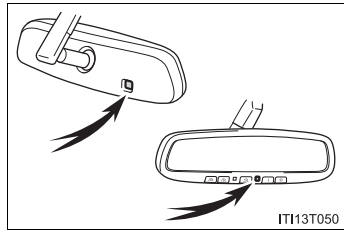

To ensure correct functioning of the sensors, do not touch or cover the sensors.

1

Before driving

⚠ CAUTION

■ While driving

Do not adjust the position of the mirror.
Doing so may lead to mishandling of the vehicle and an accident, or resulting in death or serious injury.

تلفن شبانه روزی: ۰۲۱-۸۸۶۲۰۸۵

FarmaSOS.com

1-3. Adjustable components (seats, mirrors, steering wheel) Outside rear view mirrors

Mirror angle can be adjusted.

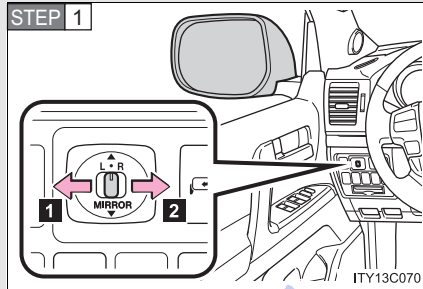

Select a mirror to adjust

- 1 Left
- 2 Right

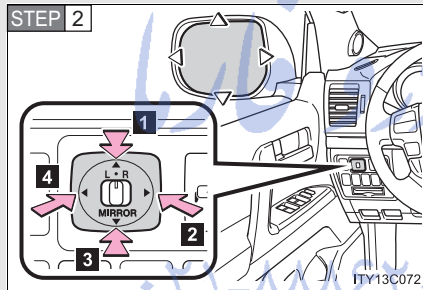

Adjust the mirror

- 1 Up
- 2 Right
- 3 Down
- 4 Left

Folding back the mirrors

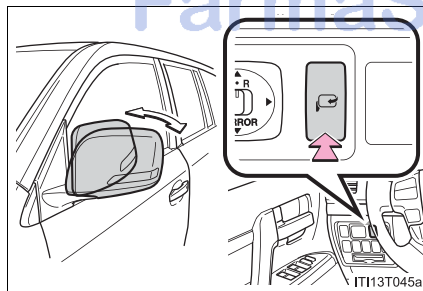

Press the switch

Pressing again will extend the mirrors.

■ **Mirror angle can be adjusted when**

The "ENGINE START STOP" switch is in ACCESSORY or IGNITION ON mode.

■ **When the mirrors are fogged up**

The outside rear view mirrors can be cleared using the mirror defoggers. Turn on the rear window defogger to turn on the outside rear view mirror defoggers. (→P. 351)

■ **Auto anti-glare function**

When the anti-glare inside rear view mirror is set to auto mode, the outside rear view mirrors will activate in conjunction with the anti-glare inside rear view mirror to reduce reflected light. (→P. 88)

■ **Linked mirror function when reversing**

When the mirror select switch is in the "L" or "R" position, the outside rear view mirrors will automatically angle downwards when the vehicle is reversing in order to give a better view of the ground. To disable this function, move the mirror select switch to the neutral position (between "L" and "R").

■ **One-touch adjustment of the mirror angle**

A desired mirror face angle can be entered to memory and adjusted with the touch of a button. (→P. 68)

1-3. Adjustable components (seats, mirrors, steering wheel)

CAUTION

■ While driving

Observe the following precautions.

Failing to do so may result in losing control of the vehicle and cause an accident, resulting in death or serious injury.

- Do not adjust the mirrors.
- Do not drive with the mirrors folded back.
- Before driving, be sure to extend mirrors and make an adjustment properly.

■ When a mirror is moving

To avoid personal injury and mirror malfunction, be careful not to get your hand caught by the moving mirror.

■ When the mirror defoggers are operating

Do not touch the rear view mirror surfaces, as they can become very hot and burn you.

NOTICE

■ If ice should jam the mirror

Do not operate the control or scrape the mirror face. Use a spray de-icer to free the mirror.

1-4. Opening and closing the windows and moon roof Power windows

The power windows can be opened and closed using the following switches.

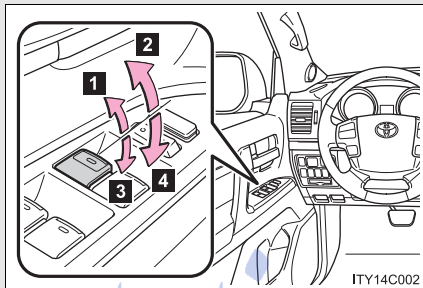

- 1 Closing
- 2 One-touch closing*
- 3 Opening
- 4 One-touch opening*

*:To stop the window partway, operate the switch in the opposite direction.

1

Before driving

Lock switch

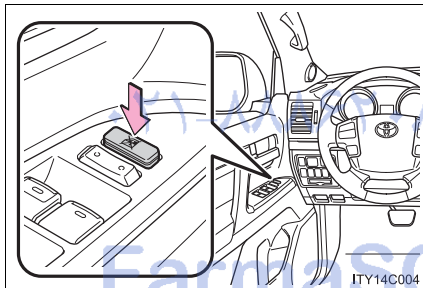

Press the switch down to lock passenger window switches.

Use this switch to prevent children from accidentally opening or closing a passenger window.

■ **The power windows can be operated when**

The “ENGINE START STOP” switch is in IGNITION ON mode.

■ **Door lock linked window operation**

The following functions can be used if customized at your Toyota dealer.

- The power windows can be opened and closed using the mechanical key. (→P. 46, 653)
- The power windows can be opened using the wireless remote control. (→P. 44)
- The power windows can be closed using the smart key system. (→P. 33)

■ **Operating the power windows after turning the “ENGINE START STOP” switch OFF**

The power windows can be operated for approximately 45 seconds even after the “ENGINE START STOP” switch is turned ACCESSORY mode or turned OFF. They cannot, however, be operated once the driver’s or front passenger’s door is opened.

■ **Jam protection function**

If an object becomes caught between the window and the window frame, window travel is stopped and the window is opened slightly.

FarmaSOS.com

■ **When the power window does not close normally**

If the jam protection function is operating abnormally and a window cannot be closed, perform the following operations using the power window switch on the relevant door.

- After stopping the vehicle, the window can be closed by holding the power window switch in the one-touch closing position while the “ENGINE START STOP” switch is turned to IGNITION ON mode.
- If the window still cannot be closed even by carrying out the operation explained above, initialize the function by performing the following procedure.

STEP 1 Hold the power window switch in the one-touch closing position. Continue holding the switch for a further 6 seconds after the window has closed.

STEP 2 Hold the power window switch in the one-touch opening position. Continue holding the switch for a further 2 seconds after the window has opened completely.

STEP 3 Hold the power window switch in the one-touch closing position once again. Continue holding the switch for a further 2 seconds after the window has closed.

If you release the switch while the window is moving, start again from the beginning. If the window continues to close but then re-open slightly even after performing the above procedure correctly, have the vehicle inspected by your Toyota dealer.

■ **Customization**

Settings (e.g. linked door lock operation) can be changed.
(Customizable features →P. 694)

1-4. Opening and closing the windows and moon roof

CAUTION

■ Closing the windows

Observe the following precautions.

Failing to do so may result in death or serious injury.

- Check to make sure that all passengers do not have any part of their body in a position where it could be caught when a window is being operated.
- Do not allow children to operate the power windows.
Closing a power window on someone can cause death or serious injury.

■ Jam protection function

- Never try jamming any part of your body to activate the jam protection function intentionally.
- The jam protection function may not work if something gets caught just before the window fully closes.

تلفن شبانه روزی: ۰۲۱-۸۸۸۶۲۰۸۵

FarmaSOS.com

1-4. Opening and closing the windows and moon roof Moon roof

Use the overhead switches to open, close, and tilt the moon roof up and down.

■ Opening and closing

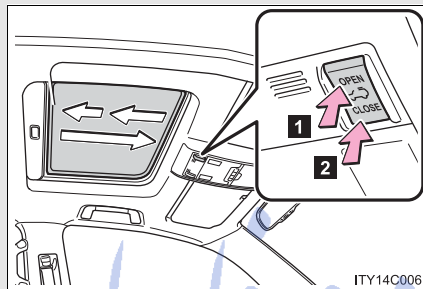

1 Open

Stops just before it is opened fully. Press the switch again to fully open.

2 Close

To stop partway, press the switch lightly.

■ Tilt up and down

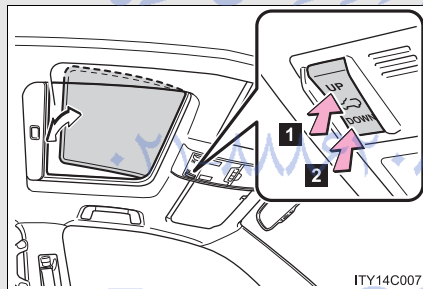

1 Tilt up

2 Tilt down

To stop partway, press the switch lightly.

1

Before driving

FarmaSOS.com

■ **The moon roof can be operated when**

The “ENGINE START STOP” switch is in IGNITION ON mode.

■ **Door lock linked moon roof operation**

The following functions can be used if customized at your Toyota dealer.

- The moon roof can be opened and closed using the mechanical key.
(→P. 46)
- The moon roof can be opened using the wireless remote control.
(→P. 44)
- The moon roof can be closed using the smart key system. (→P. 33)

■ **Operating the moon roof after turning the “ENGINE START STOP” switch OFF**

The moon roof can be operated for approximately 45 seconds even after the “ENGINE START STOP” switch is turned to ACCESSORY mode or turned OFF. It cannot, however, be operated once the driver’s or front passenger’s door is opened.

■ **Jam protection function**

If an object is detected between the moon roof and the frame while closing or tilting down, travel is stopped and the moon roof opens slightly.

■ **If the moon roof cannot be closed automatically**

Keep the switch depressed.

■ **To reduce moon roof wind noise**

When the moon roof is opened automatically, it will stop slightly before the fully open position. Driving with the moon roof in this position can help reduce wind noise.

■ **Sunshade**

The sunshade can be opened and closed manually. However, the sunshade will open automatically when the moon roof is opened.

■ **When the moon roof does not close normally**

Perform the following procedure:

- If the moon roof closes but then re-opens slightly

STEP 1 Stop the vehicle.

STEP 2 Press and hold the "CLOSE" switch.*1

The moon roof will close, reopen and pause for approximately 10 seconds.*2 Then it will close again, tilt up and pause for approximately 1 second. Finally, it will tilt down, open and close.

STEP 3 Check to make sure that the moon roof is completely closed and then release the switch.

- If the moon roof tilts down but then tilts back up

STEP 1 Stop the vehicle.

STEP 2 Press and hold the "UP" switch*1 until the moon roof moves into the tilt up position and stops.

STEP 3 Release the "UP" switch once and then press and hold the "UP" switch again.*1

The moon roof will pause for approximately 10 seconds in the tilt up position.*2 Then it will adjust slightly and pause for approximately 1 second. Finally, it will tilt down, open and close.

STEP 4 Check to make sure that the moon roof is completely closed and then release the switch.

*1: If the switch is released at the incorrect time, the procedure will have to be performed again from the beginning.

*2: If the switch is released after the above mentioned 10 second pause, automatic operation will be disabled. In that case, press and hold the "CLOSE" or "UP" switch, and the moon roof will tilt up and pause for approximately 1 second. Then it will tilt down, open and close. Check to make sure that the moon roof is completely closed and then release the switch.

If the moon roof does not fully close even after performing the above procedure correctly, have the vehicle inspected by your Toyota dealer.

1-4. Opening and closing the windows and moon roof

■ Moon roof open warning buzzer

The buzzer sounds and message is shown on the multi-information display in the instrument panel when the “ENGINE START STOP” switch is turned OFF and the driver’s door is opened with the moon roof open.

■ Customization

Settings (e.g. linked door lock operation) can be changed.
(Customizable features →P. 694)

 **CAUTION**

■ **Opening the moon roof**

Observe the following precautions.
Failing to do so may cause death or serious injury.

- Do not allow any passengers to put their hands or heads outside the vehicle while it is moving.
- Do not sit on top of the moon roof.

■ **Closing the moon roof**

Observe the following precautions.
Failing to do so may result in death or serious injury.

- Check to make sure that all passengers do not have any part of their bodies in a position where they could be caught when the moon roof is being operated.
- Do not allow children to operate the moon roof.
Closing the moon roof on someone can cause death or serious injury.

■ **Jam protection function**

- Never try jamming any part of your body to activate the jam protection function intentionally.
- The jam protection function may not work if something gets caught just before the moon roof fully closes.

1-5. Refueling Opening the fuel tank cap

Perform the following steps to open the fuel tank cap.

■ Before refueling the vehicle

- Turn the “ENGINE START STOP” switch OFF and ensure that all the doors and windows are closed.
- Confirm the type of fuel. (→P. 102)

■ Opening the fuel tank cap

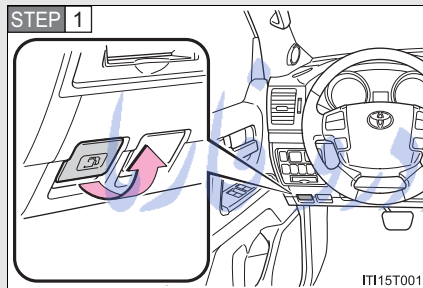

Pull the lever.

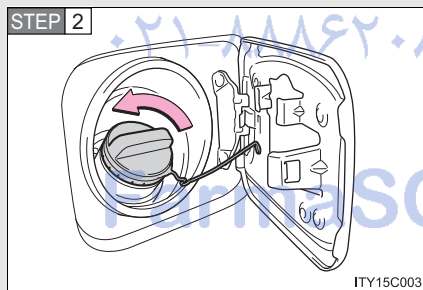

Turn the fuel tank cap slowly to open.

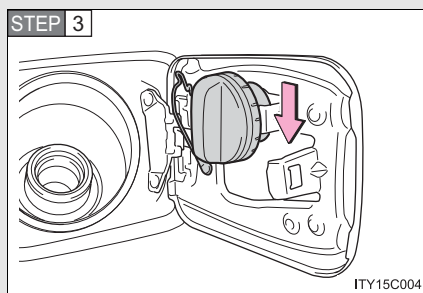

Hang the fuel tank cap on the back of the fuel filler door.

1

Before driving

1-5. Refueling

Closing the fuel tank cap

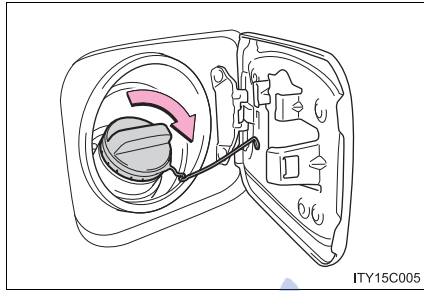

When replacing the fuel tank cap, turn it until a clicking sound is heard.

After releasing your hand, the cap will turn slightly to the opposite direction.

■ Fuel types

Use unleaded gasoline (Octane Rating 87 [Research Octane Number 91] or higher)

تلفن شبانه روزی: ۰۲۱-۸۸۶۲۰۸۵

FarmaSOS.com

⚠ CAUTION**■ Refueling the vehicle**

Observe the following precautions while refueling the vehicle. Failure to do so, may result in death or serious injury.

- Touch the vehicle or some other metal surface to discharge any static electricity.
Sparks resulting from discharging static electricity may cause the fuel vapors to ignite.
- Always hold the grips on the fuel tank cap and turn it slowly to remove it. A whooshing sound may be heard when the fuel tank cap is loosened. Wait until the sound cannot be heard before fully removing the cap. In hot weather, pressurized fuel may spray out the filler neck and cause injury.
- Do not allow anyone that has not discharged static electricity from their bodies to come close to an open fuel tank.
- Do not inhale vaporized fuel.
Fuel contains substances that are harmful if inhaled.
- Do not smoke while refueling the vehicle.
Doing so may cause the fuel to ignite and cause a fire.
- Do not return to the vehicle or touch any person or object that is statically charged.
This may cause static electricity to build up, resulting in a possible ignition hazard.

■ When replacing the fuel tank cap

Do not use anything but a genuine Toyota fuel tank cap designed for your vehicle. Failure to do so may cause a fire or other incident which may result in death or serious injury.

1

Before driving

1-5. Refueling

NOTICE

■ Refueling

Do not spill fuel during refueling.

Failing to do so may damage the vehicle, such as causing the exhaust systems to operate abnormally or damaging fuel system components or the vehicle's painted surface.

امداد خودرو فارما

تلفن شبانه روزی: ۰۲۱-۸۸۸۶۲۰۸۵

FarmaSOS.com

1-6. Theft deterrent system Engine immobilizer system

The vehicle's keys have built-in transponder chips that prevent the engine from starting if the key has not been previously registered in the vehicle's on-board computer.

Never leave the keys inside the vehicle when you leave the vehicle.

► Vehicles with navigation system

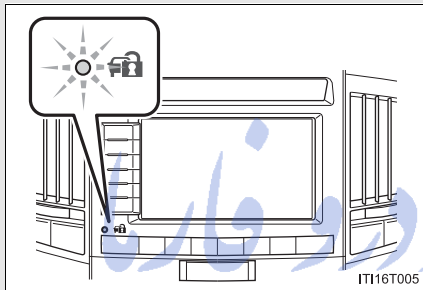

The indicator light flashes after the "ENGINE START STOP" switch has been turned OFF to indicate that the system is operating.

The indicator light stops flashing after the "ENGINE START STOP" switch has been turned to ACCESSORY or IGNITION ON mode to indicate that the system has been canceled.

► Vehicles without navigation system

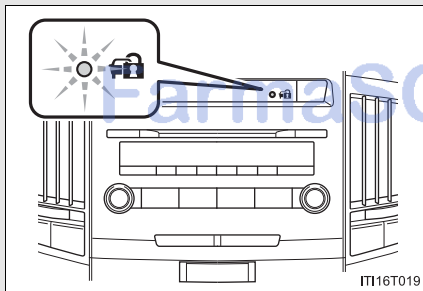

1

Before driving

1-6. Theft deterrent system

■ System maintenance

The vehicle has a maintenance-free type engine immobilizer system.

■ Conditions that may cause the system to malfunction

- If the key is in contact with a metallic object.
- If the key is in close proximity to or touching a key to the security system (key with a built-in transponder chip) of another vehicle.

■ Certifications for the engine immobilizer system

FCC ID: NI4TMIMB-1

NOTE:

This device complies with part 15 of the FCC Rules. Operation is subject to the following two conditions: (1) This device may not cause harmful interference, and (2) this device must accept any interference received, including interference that may cause undesired operation.

FCC WARNING:

Changes or modifications not expressly approved by the party responsible for compliance could void the user's authority to operate the equipment.

CAUTION

■ Certifications for the engine immobilizer system

Changes or modifications not expressly approved by the party responsible for compliance could void the user's authority to operate the equipment.

NOTICE

■ To ensure the system operates correctly

Do not modify or remove the system. If modified or removed, the proper operation of the system cannot be guaranteed.

1-6. Theft deterrent system Alarm

The system sounds the alarm and flashes lights when forcible entry is detected.

■ Triggering of the alarm

The alarm is triggered in the following situations when the alarm is set:

- A locked door is unlocked or opened in any way other than by using the smart key system, the wireless remote control or using the mechanical key. (The doors will lock again automatically)
- The hood is opened.
- The battery is reconnected.

■ Setting the alarm system

▶ Vehicles with navigation system

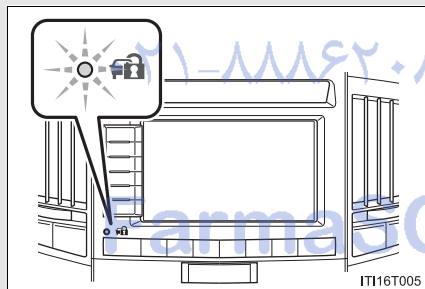

Close the doors and hood, and lock all doors.

The system will be set automatically after 30 seconds.

The indicator light changes from being on to flashing when the system is set.

▶ Vehicles without navigation system

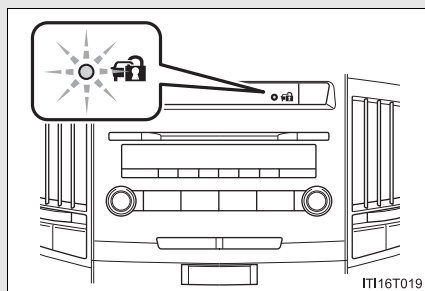

1-6. Theft deterrent system

■ Deactivating or stopping the alarm

Do one of the following to deactivate or stop the alarm.

- Unlock the doors.
- Turn the "ENGINE START STOP" switch to ACCESSORY or IGNITION ON mode, or start the engine. (The alarm will be deactivated or stopped after a few seconds.)

■ System maintenance

The vehicle has a maintenance-free type alarm system.

■ Items to check before locking the vehicle

To prevent unexpected triggering of the alarm and vehicle theft, make sure of the following.

- Nobody is in the vehicle.
- The windows and moon roof are closed before the alarm is set.
- No valuables or other personal items are left in the vehicle.

FarmaSOS.com

■ **Triggering of the alarm**

The alarm may be triggered in the following situations.
(Stopping the alarm deactivates the alarm system.)



- A person inside the vehicle opens a door or hood.

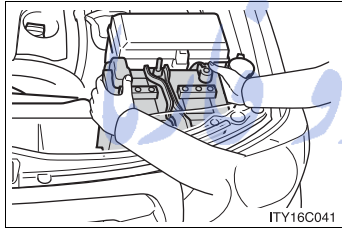

- The battery is recharged or replaced when the vehicle is locked.

1

Before driving

تلفن شبانه روزی: ۰۲۱-۸۸۶۲۰۸۵

FarmaSOS.com

1-6. Theft deterrent system

■ When the battery is disconnected

Be sure to cancel the alarm system.

If the battery is disconnected before canceling the alarm, the system may be triggered when the battery is reconnected.

■ Alarm-operated door lock

- When the alarm is operating, the doors are locked automatically to prevent intruders.
- Do not leave the key inside the vehicle when the alarm is operating, and make sure the key is not inside the vehicle when recharging or replacing the battery.

■ Panic mode

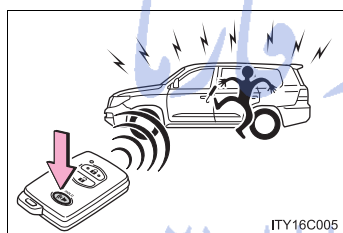

When  is pressed for longer than about one second, the headlights/tail lights/emergency flashers will flash, the front and rear interior lights will come on, and an alarm will sound for about 60 seconds to deter any person from trying to break into or damage your vehicle.

To stop the alarm, press any button on the wireless remote control.

NOTICE

■ To ensure the system operates correctly

Do not modify or remove the system. If modified or removed, the proper operation of the system cannot be guaranteed.

1-7. Safety information Correct driving posture

Drive with a good posture as follows:

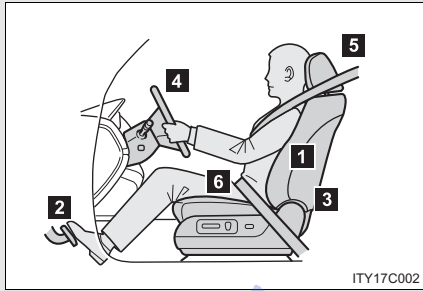

- 1** Sit upright and well back in the seat. (→P. 57)
- 2** Adjust the position of the seat forward or backward to ensure the pedals can be reached and easily depressed to the extent required. (→P. 57)
- 3** Adjust the seatback so that the controls are easily operable.
- 4** Adjust the tilt and telescopic positions of the steering wheel downward so the air-bag is facing your chest. (→P. 86)
- 5** Lock the head restraint in place with the center of the head restraint closest to the top of your ears. (→P. 72)
- 6** Wear the seat belt correctly. (→P. 76)

1

Before driving

 CAUTION

■ **While driving**

- Do not adjust the position of the driver's seat.
Doing so could cause the driver to lose control of the vehicle.
- Do not place a cushion between the driver or passenger and the seatback.
A cushion may prevent correct posture from being achieved, and reduce the effectiveness of the seat belt and head restraint, increasing the risk of death or serious injury to the driver or passenger.
- Do not place anything under the front seats.
Objects placed under the front seats may become jammed in the seat tracks and stop the seat from locking in place. This may lead to an accident. The adjustment mechanism may also be damaged.

■ **Adjusting the seat position**

- Do not recline the seat more than necessary when the vehicle is in motion, to reduce the risk of sliding under the lap belt.
If the seat is too reclined during an accident, the lap belt may slide past the hips and apply restraint forces directly to the abdomen or your neck may contact the shoulder belt, increasing the risk of death or serious injury.
- Take care when adjusting the seat position to ensure that other passengers are not injured by the moving seat.
- Do not put your hands under the seat or near the moving parts to avoid injury.
Fingers or hands may become jammed in the seat mechanism.

1-7. Safety information SRS airbags

The SRS airbags inflate when the vehicle is subjected to certain types of severe impacts that may cause significant injury to the occupants. They work together with the seat belts to help reduce the risk of death or serious injury.

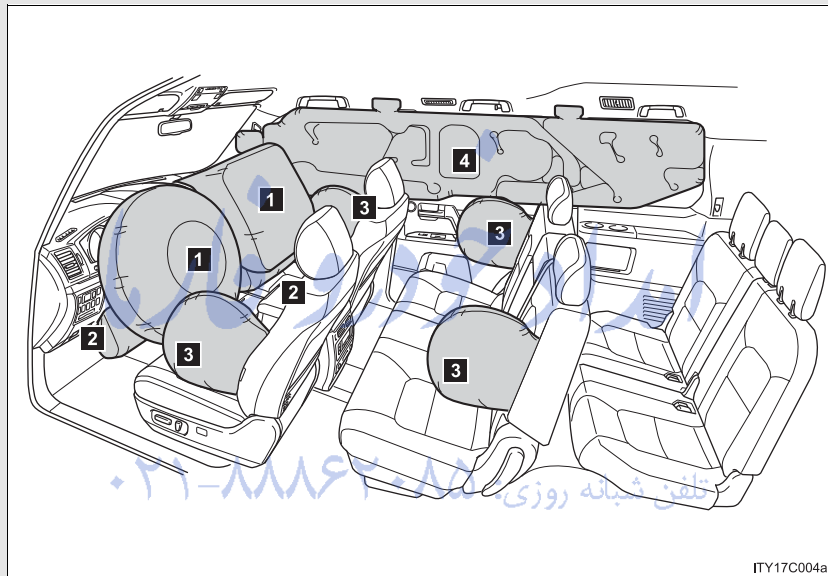

► Front airbags

- 1** Driver airbag/front passenger airbag
Can help protect the head and chest of the driver and front passenger from impact with interior components.
- 2** Knee airbags
Can help provide driver and front passenger protection.

1

Before driving

1-7. Safety information

► Side and curtain shield airbags

3 Side airbags

Can help protect the torso of the front and second outboard seat occupants.

4 Curtain shield airbags

Can help protect primarily the head of front seat occupants, second and third outboard seat occupants.

امداد خودرو فارما

تلفن شبانه روزی: ۰۲۱-۸۸۸۶۲۰۸۵

FarmaSOS.com

Airbag system components

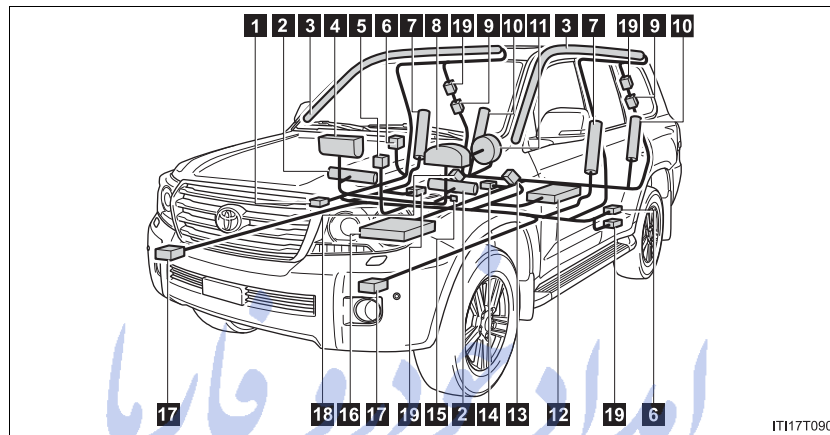

- | | |
|-------------------------------------------------------------------------|-------------------------------------------------------------|
| 1 Front passenger occupant classification system (ECU & sensors) | 10 Side airbags (second outboard seats) |
| 2 Knee airbags | 11 Driver airbag |
| 3 Curtain shield airbags | 12 Driver's seat position sensor |
| 4 Front passenger airbag | 13 Driver's seat belt buckle switch |
| 5 "AIR BAG ON" and "AIR BAG OFF" indicator lights | 14 Safing sensor (rear) |
| 6 Side impact sensors (front door) | 15 Roll sensing of curtain shield airbags off switch |
| 7 Side airbags (front seats) | 16 Airbag sensor assembly |
| 8 SRS warning light and "RSCA OFF" indicator light | 17 Front impact sensors |
| 9 Side impact sensors (rear) | 18 Front passenger's seat belt buckle switch |
| | 19 Seat belt pretensioners |

1

Before driving

1-7. Safety information

Your vehicle is equipped with ADVANCED AIRBAGS designed based on the US motor vehicle safety standards (FMVSS208). The airbag sensor assembly (ECU) controls airbag deployment based on information obtained from the sensors etc. shown in the system components diagram above. This information includes crash severity and occupant information. As the airbags deploy, a chemical reaction in the inflators quickly fills the airbags with nontoxic gas to help restrain the motion of the occupants.

■ If the SRS airbags deploy (inflate)

- Bruising and slight abrasions may result from contact with a deploying (inflating) SRS airbag.
- A loud noise and white powder will be emitted.
- Parts of the airbag module (steering wheel hub, airbag cover and inflator) as well as the front seats, second seats, and parts of the front, side and rear pillars, and roof side rail, may be hot for several minutes. The airbag itself may also be hot.
- The windshield may crack.
- For Safety Connect subscribers, if the SRS airbags deploy or in the event of a severe rear-end collision, the system is designed to send an emergency call to the response center, notifying them of the vehicle's location (without needing to push the "SOS" button) and an agent will attempt to speak with the occupants to ascertain the level of emergency and assistance required. If the occupants are unable to communicate, the agent automatically treats the call as an emergency and helps to dispatch the necessary emergency services. (→P. 504)

■ SRS airbag deployment conditions (SRS front airbags)

- The SRS front airbag will deploy in the event of an impact that exceeds the set threshold level (the level of force corresponding to an approximately 12 - 18 mph [20 - 30 km/h] frontal collision with a fixed wall that does not move or deform).

However, this threshold velocity will be considerably higher in the following situations:

- If the vehicle strikes an object, such as a parked vehicle or sign pole, which can move or deform on impact
- If the vehicle is involved in an underride collision, such as a collision in which the front of the vehicle “underrides”, or goes under, the bed of a truck
- Depending on the type of collision, it is possible that only the seat belt pretensioners will activate.
- The SRS front airbags for the front passenger will not activate if there is not passenger sitting in the front passenger seat. However, the front airbags for the front passenger may deploy if luggage is put in the seat, even if the seat is unoccupied.

■ SRS airbag deployment conditions (SRS side airbags and SRS curtain shield airbags)

- The SRS side airbags and SRS curtain shield airbags will deploy in the event of an impact that exceeds the set threshold level (the level of force corresponding to the impact force produced by an approximately 3300 lb. [1500 kg] vehicle colliding with the vehicle cabin from a direction perpendicular to the vehicle orientation at an approximate speed of 12 - 18 mph [20 - 30 km/h]).
- The SRS curtain shield airbags will deploy in the event of vehicle rollover.

1

Before driving

1-7. Safety information

■ Conditions under which the SRS airbags may deploy (inflate), other than a collision

The SRS front airbags may also deploy if a serious impact occurs to the underside of your vehicle. Some examples are shown in the illustration.

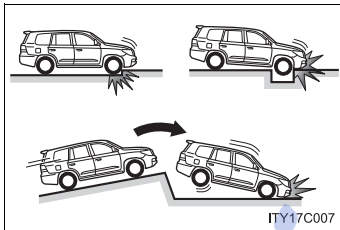

- Hitting a curb, edge of pavement or hard surface
- Falling into or jumping over a deep hole
- Landing hard or falling

The SRS curtain shield airbags may also deploy under the situations shown in the illustration.

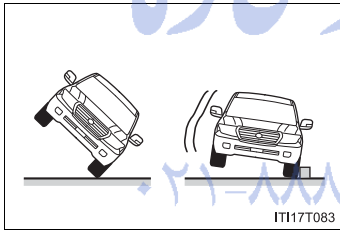

- The angle of vehicle tip-up is marginal.
- The vehicle skids and hits a curb stone.

■ Types of collisions that may not deploy the SRS airbag (front airbags)

The SRS front airbags do not generally inflate if the vehicle is involved in a side or rear collision, if it rolls over, or if it is involved in a low-speed frontal collision. But, whenever a collision of any type causes sufficient forward deceleration of the vehicle, deployment of the SRS front airbags may occur.

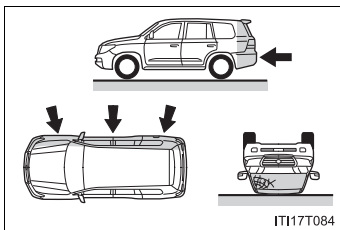

- Collision from the side
- Collision from the rear
- Vehicle rollover

■ **Types of collisions that may not deploy the SRS airbag (side and curtain shield airbags)**

The SRS side airbag and curtain shield airbag may not activate if the vehicle is subjected to a collision from the side at certain angles, or a collision to the side of the vehicle body other than the passenger compartment.

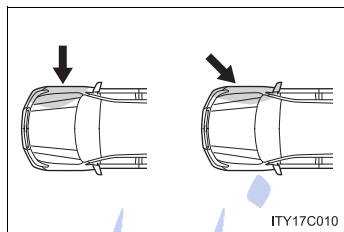

- Collision from the side to the vehicle body other than the passenger compartment
- Collision from the side at an angle

The SRS side airbags do not generally inflate if the vehicle is involved in a frontal or rear collision, if it rolls over, or if it is involved in a low-speed side collision.

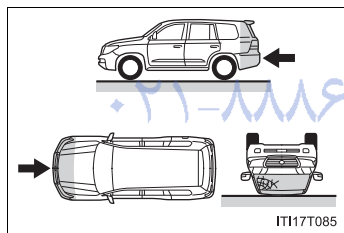

- Collision from the front
- Collision from the rear
- Vehicle rollover

The SRS curtain shield airbags do not generally inflate if the vehicle is involved in a frontal or rear collision, if it pitches end over end, or if it is involved in a low-speed side collision.

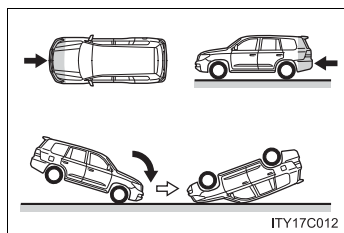

- Collision from the front
- Collision from the rear
- Pitching end over end

1

Before driving

1-7. Safety information

■ When to contact your Toyota dealer

In the following cases, contact your Toyota dealer as soon as possible.

- Any of the SRS airbags have been inflated.

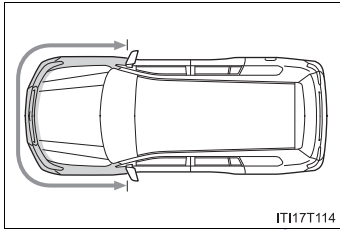

- The front of the vehicle is damaged or deformed, or the vehicle was involved in an accident that was not severe enough to cause the SRS front airbags to inflate.

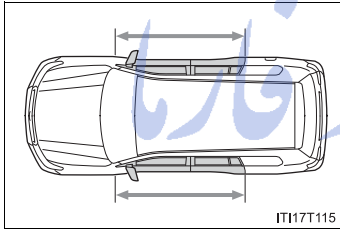

- A portion of the doors is damaged or deformed, or the vehicle was involved in an accident that was not severe enough to cause the SRS side and curtain shield airbags to inflate.

تلفن شبانه روزی: ۰۲۱-۸۸۶۲۰۸۵

FarmaSOS.com

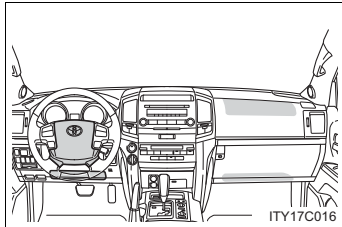

- The pad section of the steering wheel, dashboard near the front passenger airbag or lower portion of the instrument panel is scratched, cracked or otherwise damaged.

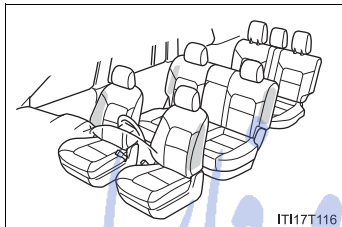

- The surface of the seats with the side airbag is scratched, cracked, or otherwise damaged.

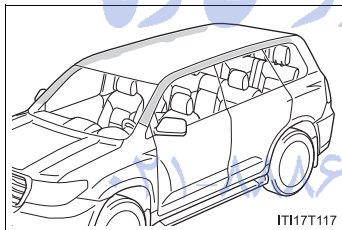

- The portion of the front, side and rear pillars or roof side rail garnishes (padding) containing the curtain shield airbags is inside scratched, cracked, or otherwise damaged.

1

Before driving

FarmaSOS.com

 CAUTION

■ **SRS airbag precautions**

Observe the following precautions regarding the SRS airbags. Failure to do so may cause death or serious injury.

- The driver and all passengers in the vehicle must wear their seat belts properly.

The SRS airbags are supplemental devices to be used with the seat belts.

- The SRS driver airbag deploys with considerable force, and can cause death or serious injury especially if the driver is very close to the airbag. The National Highway Traffic Safety Administration (“NHTSA”) advises:

Since the risk zone for driver airbag is the first 2 - 3 in. (50 - 75 mm) of inflation, placing yourself 10 in. (250 mm) from your driver airbag provides you with a clear margin of safety. This distance is measured from the center of the steering wheel to your breastbone. If you sit less than 10 in. (250 mm) away now, you can change your driving position in several ways:

- Move your seat to the rear as far as you can while still reaching the pedals comfortably.
- Slightly recline the back of the seat.
Although vehicle designs vary, many drivers can achieve the 10 in. (250 mm) distance, even with the driver seat all the way forward, simply by reclining the back of the seat somewhat. If reclining the back of your seat makes it hard to see the road, raise yourself by using a firm, non-slippery cushion, or raise the seat if your vehicle has that feature.
- If your steering wheel is adjustable, tilt it downward. This points the airbag toward your chest instead of your head and neck.

The seat should be adjusted as recommended by NHTSA above, while still maintaining control of the foot pedals, steering wheel, and your view of the instrument panel controls.

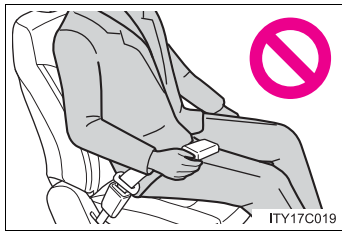
⚠ CAUTION**■ SRS airbag precautions**

- If the seat belt extender has been connected to the front seat belt buckles but the seat belt extender has not also been fastened to the latch plate of the seat belt, the SRS front airbags will judge that the driver and front passenger are wearing the seat belt even though the seat belt has not been connected. In this case, the SRS front airbags may not activate correctly in a collision, resulting in death or serious injury in the event of collision. Be sure to wear the seat belt with the seat belt extender.

- The SRS front passenger airbag also deploys with considerable force, and can cause death or serious injury especially if the front passenger is very close to the airbag. The front passenger seat should be as far from the airbag as possible with the seatback adjusted, so the front passenger sits upright.

- Improperly seated and/or restrained infants and children can be killed or seriously injured by a deploying airbag. An infant or child who is too small to use a seat belt should be properly secured using a child restraint system. Toyota strongly recommends that all infants and children be placed in the rear seats of the vehicle and properly restrained. The rear seats are safer for infants and children than the front passenger seat. (→P. 135)

1

Before driving

⚠ CAUTION

■ SRS airbag precautions

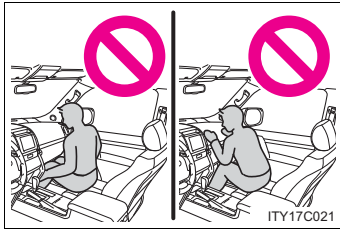

- Do not sit on the edge of the seat or lean against the dashboard.

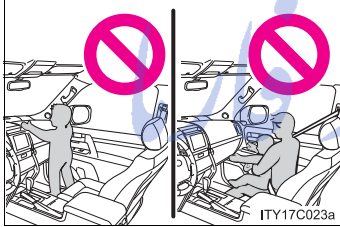

- Do not allow a child to stand in front of the SRS front passenger airbag unit or sit on the knees of a front passenger.
- Do not allow the front seat occupants to hold items on their knees.



- Do not lean against the door, the roof side rail or the front, center and rear pillars.

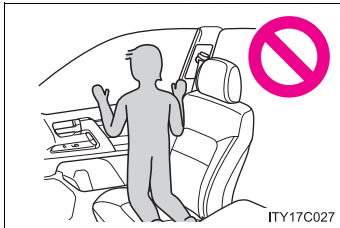

- Do not allow anyone to kneel on the passenger seat toward the door or put their head or hands outside the vehicle.

⚠ CAUTION

■ SRS airbag precautions

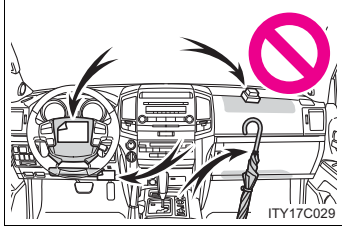

ITY17C029

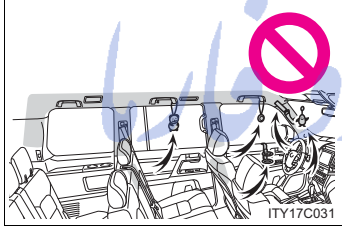

ITY17C031

- Do not attach anything to or lean anything against areas such as the dashboard or steering wheel pad or lower portion of the instrument panel. These items can become projectiles when SRS driver, front passenger and knee airbags deploy.
- Do not attach anything to areas such as a door, windshield glass, side door glass, front, center and rear pillars, roof side rail or assist grip.
- Do not hang coat hangers or other hard objects on the coat hooks. All of these items could become projectiles and may cause death or serious injury, should the SRS curtain shield airbag deploy.

۰۲۱-۸۸۶۲۰۸۸۸
تلفن شبانه روزی: ۰۲۱-۸۸۶۲۰۸۸۸

1

Before driving

FarmaSOS.com

 CAUTION

■ SRS airbag precautions

- If a vinyl cover is put on the area where the SRS knee airbag will deploy, be sure to remove it.
- Do not use seat accessories which cover the parts where the SRS side airbags inflate as they may interfere with inflation of the airbags.
- Do not strike or apply significant levels of force to the area of the SRS airbag components. Doing so can cause the SRS airbags to malfunction.
- Do not touch any of the component parts immediately after the SRS airbags have deployed (inflated) as they may be hot.
- If breathing becomes difficult after the SRS airbag have deployed, open a door or window to allow fresh air in, or leave the vehicle if it is safe to do so. Wash off any residue as soon as possible to prevent skin irritation.
- If the areas where the SRS airbags are stored, such as the steering wheel pad and front, center and rear pillar garnishes, are damaged or cracked, have them replaced by your Toyota dealer.

تلفن شبانه روزی: ۰۲۱-۸۸۶۲۰۸۵

FarmaSOS.com

⚠ CAUTION**■ Modification and disposal of SRS airbag system components**

Do not dispose of your vehicle or perform any of the following modifications without consulting your Toyota dealer. The SRS airbag may malfunction or deploy (inflate) accidentally, causing death or serious injury.

- Installation, removal, disassembly and repair of the SRS airbags
- Repairs, modifications, removal or replacement of the steering wheel, instrument panel, dashboard, seats or seat upholstery, front, side and rear pillars or roof side rail
- Repairs or modifications of the front fender, front bumper, or side of the occupant compartment
- Installation of a grille guard (bull bars, kangaroo bar, etc.), snow plows or winches
- Modifications to the vehicle's suspension system
- Installation of electronic devices such as mobile two-way radios (RF-transmitter) and CD players
- Modifications to your vehicle for a person with a physical disability

1

Before driving

FarmaSOS.com

Deactivating the curtain shield airbags in a vehicle rollover

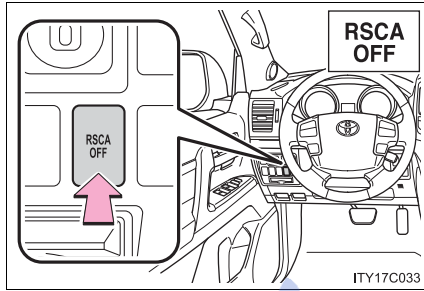

ON/OFF (hold for a few seconds)

The RSCA OFF indicator turns on (only when the “ENGINE START STOP” switch is in IGNITION ON mode.)

The roll sensing function for the curtain shield airbags and seat belt pretensioners will turn back on automatically each time the “ENGINE START STOP” switch is turned to IGNITION ON mode.

■ This switch only should be used

In a situation where the inflation is not desired (such as during extreme off road driving).

■ Operating conditions when the RSCA OFF indicator is on

- The curtain shield airbag and seat belt pretensioner will not activate in a vehicle rollover.
- The curtain shield airbag will activate in a severe side impact.
- The pretensioner will activate in a severe frontal collision.

⚠ CAUTION

■ While normal driving

Make sure the RSCA OFF indicator is not turned on. If it is left on, the curtain shield airbag will not activate in the event of an accident, which may result in death or serious injury.

1-7. Safety information

Front passenger occupant classification system

Your vehicle is equipped with a front passenger occupant classification system. This system detects the conditions of the front passenger seat and activates or deactivates the devices for front passenger.

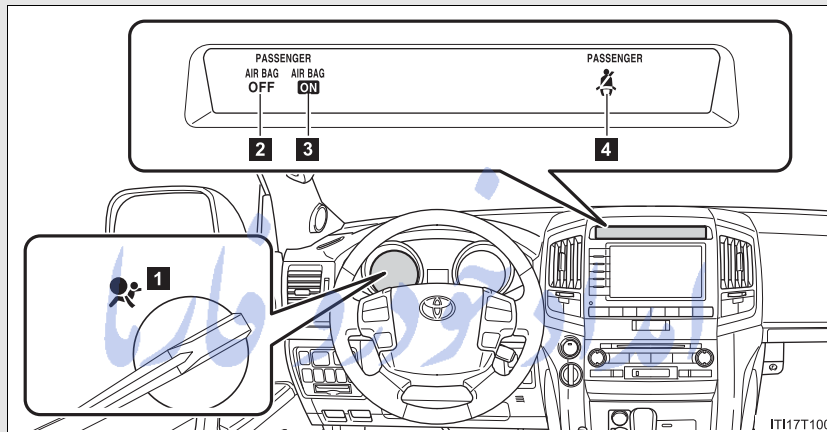

- 1 SRS warning light
- 2 AIR BAG OFF indicator light
- 3 AIR BAG ON indicator light
- 4 Front passenger's seat belt reminder light

1

Before driving

FarmaSOS.com

Condition and operation in the front passenger occupant classification system

■ **Adult*1**

Indicator/ warning light	AIR BAG ON and AIR BAG OFF indicator lights	“AIR BAG ON”
	SRS warning light	Off
	Front passenger’s seat belt reminder light	Flashing*2
Devices	Front passenger airbag and knee airbag	Activated
	Side airbag in the front passenger seat	
	Curtain shield airbag on the front passenger side	
	Front passenger’s seat belt pretensioner	

■ **Child*3 or child restraint system*4**

Indicator/ warning light	AIR BAG ON and AIR BAG OFF indicator lights	“AIR BAG OFF”*5
	SRS warning light	Off
	Front passenger’s seat belt reminder light	Flashing*2
Devices	Front passenger airbag and knee airbag	Deactivated
	Side airbag in the front passenger seat	Activated
	Curtain shield airbag on the front passenger side	
	Front passenger’s seat belt pretensioner	

■ **Unoccupied**

Indicator/ warning light	AIR BAG ON and AIR BAG OFF indicator lights	Not illumi- nated
	SRS warning light	Off
	Front passenger's seat belt reminder light	
Devices	Front passenger airbag and knee airbag	Deactivated
	Side airbag in the front passenger seat	Activated
	Curtain shield airbag on the front passenger side	
	Front passenger's seat belt pretensioner	Deactivated

1

Before driving

امداد خودرو فارما
تلفن شبانه روزی: ۰۲۱-۸۸۸۶۲۰۸۵

FarmaSOS.com

■ System malfunction

Indicator/ warning light	AIR BAG ON and AIR BAG OFF indicator lights	“AIR BAG OFF”
	SRS warning light	On
	Front passenger’s seat belt reminder light	Off
Devices	Front passenger airbag and knee airbag	Deactivated
	Side airbag in the front passenger seat	Activated
	Curtain shield airbag on the front passenger side	
	Front passenger’s seat belt pretensioner	

- *1: The system judges a person of adult size as an adult. When a smaller adult sits in the front passenger seat, the system may recognize him/her as a child depending on his/her physique and posture.
- *2: In the event the front passenger does not wear a seat belt.
- *3: When a larger child who has outgrown a child restraint system sits in the front passenger seat, the system may recognize him/her as an adult depending on his/her physique or posture.
- *4: Never install a rear-facing child restraint system on the front passenger seat. A forward-facing child restraint system should only be installed on the front passenger seat when it is unavoidable. (→P. 135)
- *5: In case the indicator is not illuminated, consult this manual as for installing the child restraint system properly. (→P. 140)

⚠ CAUTION**■ Front passenger occupant classification system precautions**

Observe the following precautions regarding front passenger occupant classification system.

Failure to do so may cause death or serious injury.

- Wear the seat belt properly.
- Make sure the front passenger's seat belt tab has not been left inserted into the buckle before someone sits in the front passenger seat.
- Make sure the AIR BAG OFF indicator light is not illuminated when using the seat belt extender for the front passenger seat. If the AIR BAG OFF indicator light is illuminated, disconnect the extender tongue from the seat belt buckle, then reconnect the seat belt. Reconnect the seat belt extender after making sure the AIR BAG ON indicator light is illuminated. If you use the seat belt extender while the AIR BAG OFF indicator light is illuminated, the SRS airbags for the passenger may not activate correctly, which could cause death or serious injury in the event of collision.
- Do not apply a heavy load to the front passenger seat.
- Do not put weight on the front passenger seat by putting your hands or feet on the front passenger seat seatback from the second seat.
- Do not let a second seat passenger lift the front passenger seat with their feet or press on the seatback with their legs.
- Do not put objects under the front passenger seat.
- Do not recline the front passenger seatback so far that it touches a second seat. This may cause the AIR BAG OFF indicator light to be illuminated, which indicates that the passenger's airbags will not deploy in the event of a severe accident. If the seatback touches the second seat, return the seatback to a position where it does not touch the second seat. Keep the front passenger seatback as upright as possible when the vehicle is moving. Reclining the seatback excessively may lessen the effectiveness of the seat belt system.

1

Before driving

 CAUTION

■ **Front passenger occupant classification system precautions**

- If an adult sits in the front passenger seat, the AIR BAG ON indicator light is illuminated. If the AIR BAG OFF indicator is illuminated, ask the passenger to sit up straight, well back in the seat, feet on the floor, and with the seat belt worn correctly. If the AIR BAG OFF indicator still remain illuminated, either ask the passenger to move to the second seat, or if that is not possible, move the front passenger seat fully rearward.
- When it is unavoidable to install the forward-facing child restraint system on the front passenger seat, install the child restraint system on the front passenger seat in the proper order. (→P. 140)
- Do not modify or remove the front seat.
- Do not kick the front passenger seat or subject it to severe impact. Otherwise, the SRS warning light may come on to indicate a malfunction in the detection system. In this case, contact your Toyota dealer immediately.
- Do not use a seat accessory, such as a cushion or seat cover, that covers the seat cushion surface.
- Child restraint systems installed on the second seat should not contact the front seatbacks.

FarmaSOS.com

1-7. Safety information Child restraint systems

A child restraint system for a small child or baby must itself be properly restrained on the seat with the lap portion of the lap/shoulder belt.

The laws of all 50 states of the U.S.A. now require the use of child restraint systems.

1

Before driving

Points to remember

Studies have shown that installing a child restraint on a rear seat is much safer than installing one to the front passenger seat.

- Choose a child restraint system that suits your vehicle and is appropriate to the age and size of the child.
- For installation details, follow the instructions provided with the child restraint system.

General installation instructions are provided in this manual.

(→P. 140)

FarmaSOS.com

Types of child restraints

Child restraint systems are classified into the following 3 types according to the age and size of the child.

- ▶ Rear facing—Infant seat/convertible seat

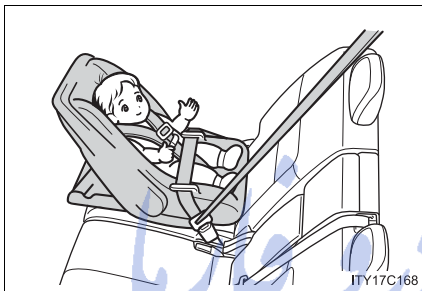

- ▶ Forward facing—Convertible seat



- ▶ Booster seat

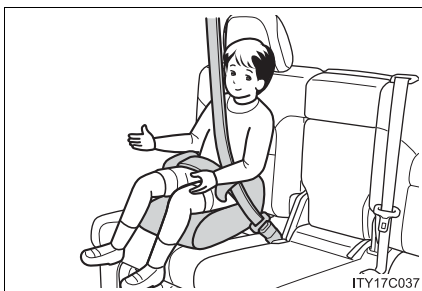

■ When installing the child restraint system on the front passenger seat

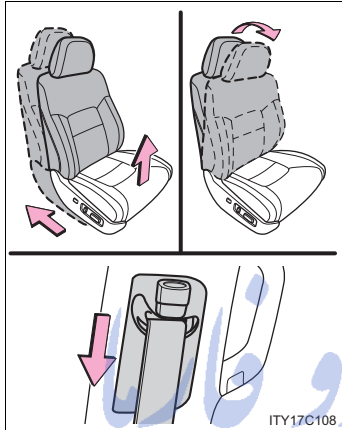

When you have to use a child restraint system on the front passenger seat, adjust the following:

- The seatback to the most upright position
- The seat cushion to the fully rearward and highest position
- The seat belt height to the lowest position

1

Before driving

■ Selecting an appropriate child restraint system

- Use a child restraint system appropriate for the child until the child becomes large enough to properly wear the vehicle's seat belt.
- If a child is too large for a child restraint system, sit the child on a rear seat and use the vehicle's seat belt. (→P. 76)

FarmaSOS.com

 CAUTION

■ **Using a child restraint system**

The use of a child restraint system not suitable for the vehicle may not properly secure the infant or child, resulting in serious injury or even death.

■ **Child restraint precautions**

- For effective protection in automobile accidents and sudden stops, a child must be properly restrained, using a seat belt or child restraint system depending on the age and size of the child. Holding a child in your arms is not a substitute for a child restraint system. In an accident, the child can be crushed against the windshield, or between you and the vehicle's interior.
- Toyota strongly urges the use of a proper child restraint system that conforms to the size of the child, installed on the rear seat. According to accident statistics, the child is safer when properly restrained in the rear seat than in the front seat.
- Never install a rear-facing child restraint system on the front passenger seat even if the AIR BAG OFF indicator light illuminates. In the event of an accident, the force of the rapid inflation of the front passenger airbag can cause death or serious injury to the child if the rear-facing child restraint system is installed on the front passenger seat.
- A forward-facing child restraint system may be installed on the front passenger seat only when it is unavoidable. A child restraint system that requires a top tether strap should not be used in the front passenger seat since there is no top tether strap anchor for the front passenger seat. Adjust the seatback as upright as possible and always move the seat as far back as possible even if the AIR BAG OFF indicator light illuminates, because the front passenger airbag could inflate with considerable speed and force. Otherwise, the child may be killed or seriously injured.

⚠ CAUTION**■ Child restraint precautions**

- Do not use the seat belt extender when installing a child restraint system on the front or rear passenger seat. If installing a child restraint system with the seat belt extender connected to the seat belt, the seat belt will not securely hold the child restraint system, which could cause death or serious injury to the child or other passengers in the event of a sudden stop, sudden swerve or accident.
- Do not allow the child to lean his/her head or any part of his/her body against the door or the area of the seat, front, center and rear pillars or roof side rail from which the side airbags or curtain shield airbags deploy even if the child is seated in the child restraint system. It is dangerous if the side airbags and curtain shield airbags inflate, and the impact could cause death or serious injury to the child.
- Make sure you have complied with all installation instructions provided by the child restraint manufacturer and that the system is properly secured. If it is not secured properly, it may cause death or serious injury to the child in the event of a sudden stop, sudden swerve or accident.

■ When children are in the vehicle

Do not allow children to play with the seat belt. If the seat belt becomes twisted around a child's neck, it may lead to choking or other serious injuries that could result in death.

If this occurs and the buckle cannot be unfastened, scissors should be used to cut the belt.

■ When the child restraint system is not in use

- Keep the child restraint system properly secured on the seat even if it is not in use. Do not store the restraint unsecured in the passenger compartment.
- If it is necessary to detach the child restraint system, remove it from the vehicle or store it securely in the luggage compartment. This will prevent it from injuring passengers in the event of a sudden stop, sudden swerve or accident.

1

Before driving

1-7. Safety information

Installing child restraints

Follow the child restraint system manufacturer's instructions. Firmly secure the child restraints using the LATCH anchors or a seat belt. Attach the top tether strap when installing a child restraint.

The lap/shoulder belt can be used if your child restraint system is not compatible with the LATCH (Lower Anchors and Tethers for Children) system.

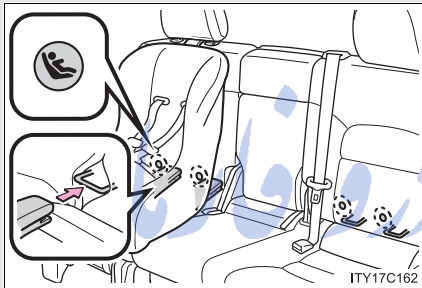

Child restraint LATCH anchors

LATCH anchors are provided for the outside second seat. (Buttons displaying the location of the anchors are attached to the seats.)

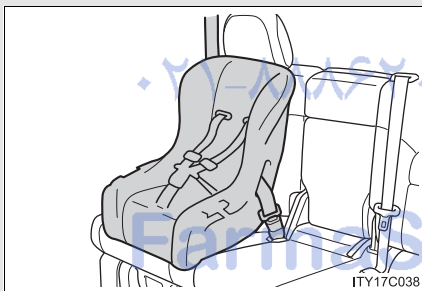

Seat belts equipped with a child restraint locking mechanism (ALR/ELR belts except driver's seat belt) (→P. 76)

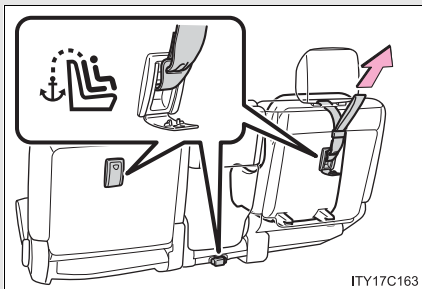

Anchor bracket (for top tether strap)

Anchor brackets are provided for all second seats.

Installation with LATCH system

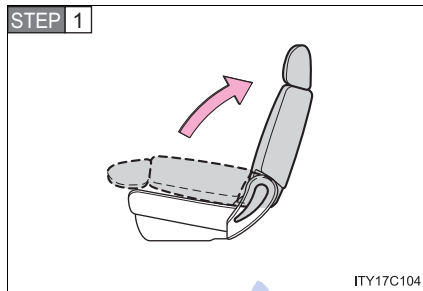

Fold the seatback forward and then adjust it as upright as possible.

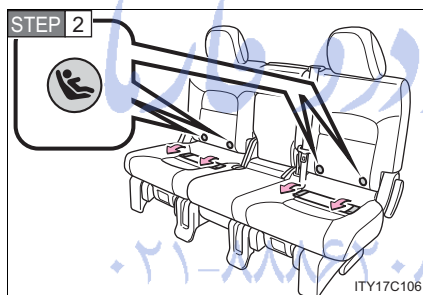

Take off the covers between the seat cushion and seatback, then confirm the position of the LATCH anchors below the symbol in the seatback.

1
Before driving

FarmaSOS.com

1-7. Safety information

► Type A

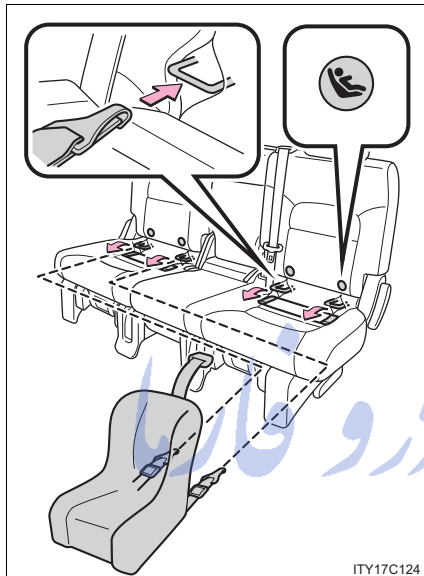

STEP 3 Latch the hooks of the lower straps onto the LATCH anchors.

STEP 4 If the child restraint has a top tether strap, the top tether strap should be latched onto the top tether strap anchor.

► Type B

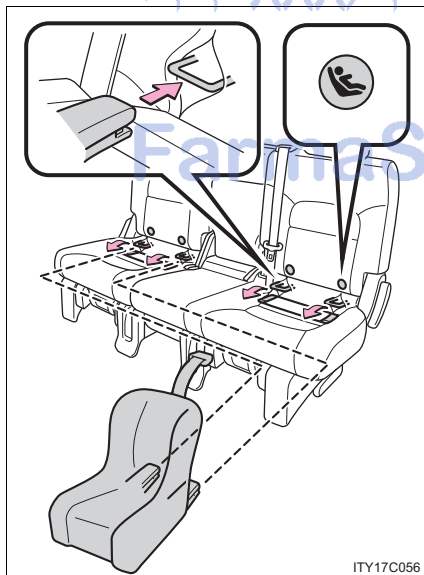

STEP 3 Latch the buckles onto the LATCH anchors.

STEP 4 If the child restraint has a top tether strap, the top tether strap should be latched onto the top tether strap anchor.

Installing child restraints using a seat belt (child restraint lock function belt)

■ **Rear-facing — Infant seat/convertible seat**

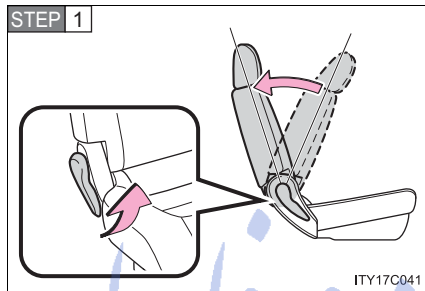

Fold the seatback while pulling the seatback angle lever. Return the seatback and secure it at the first lock position. (→P. 59)

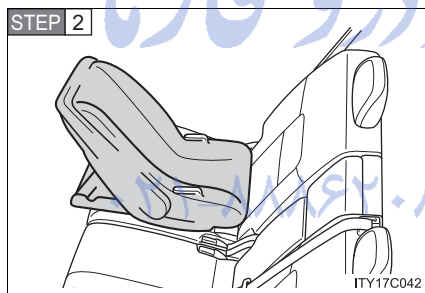

Place the child restraint system on the second or third seat facing the rear of the vehicle.

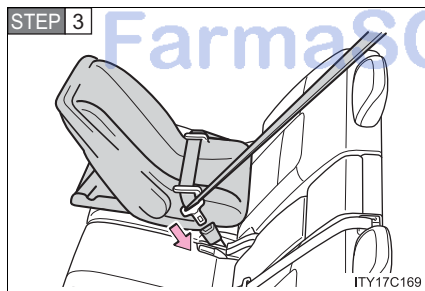

Run the seat belt through the child restraint system and insert the plate into the buckle. Make sure that the belt is not twisted.

1
Before driving

1-7. Safety information

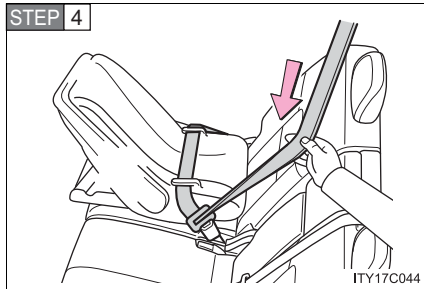

Fully extend the shoulder belt and then allow it to retract slightly in order to activate the ALR lock mode.

Lock mode allows the seat belt to retract only.

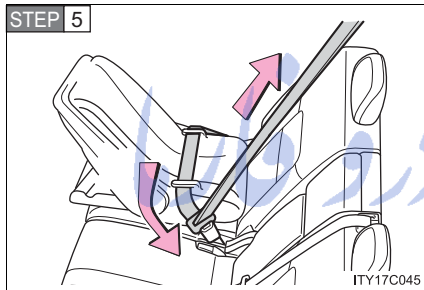

While pushing the child restraint system down into the seat, allow the shoulder belt to retract until the child restraint system is securely in place.

After the shoulder belt has retracted to a point where there is no slack in the belt, pull the belt to check that it cannot be extended.

تلفن شبانه روزی: ۰۲۱-۸۸۶۲۰۸۵

FarmaSOS.com

■ Forward-facing — Convertible seat

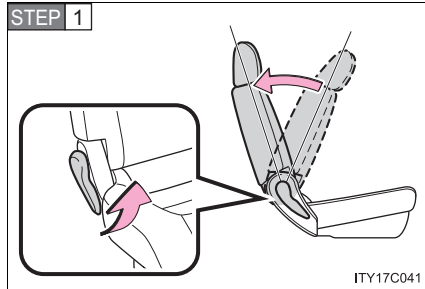

Fold the seatback while pulling the seatback angle lever. Return the seatback and secure it at the first lock position. (→P. 59)

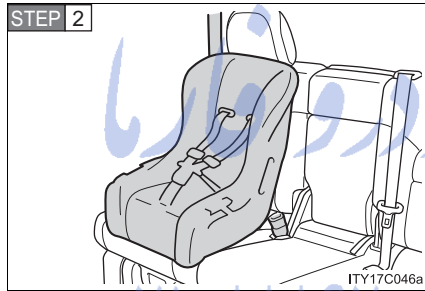

Place the child restraint system on the second or third seat facing the front of the vehicle.

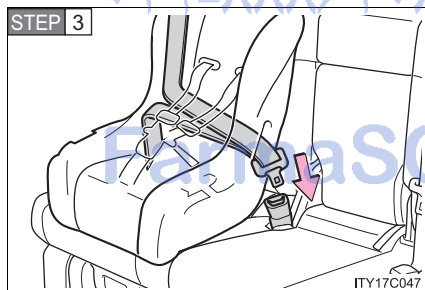

Run the seat belt through the child restraint system and insert the plate into the buckle. Make sure that the belt is not twisted.

1

Before driving

1-7. Safety information

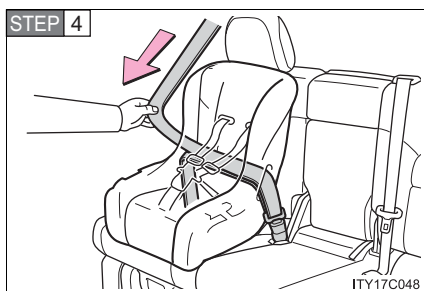

Fully extend the shoulder strap and then allow it to retract slightly into the ALR lock mode.

Lock mode allows the seat belt to retract only.

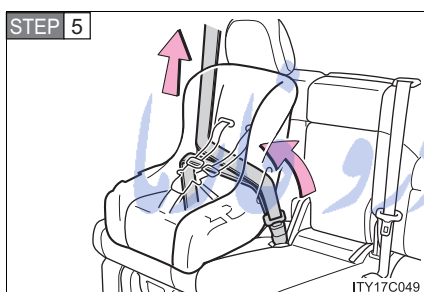

While pushing the child restraint system into the seat, allow the shoulder belt to retract until the child restraint system is securely in place.

After the shoulder belt has retracted to a point where there is no slack in the belt, pull the belt to check that it cannot be extended.

STEP 6 If the child restraint system has a top tether strap, the top tether strap should be latched onto the top tether strap anchor. (→P. 141)

FarmaSOS.com

■ **Booster seat**

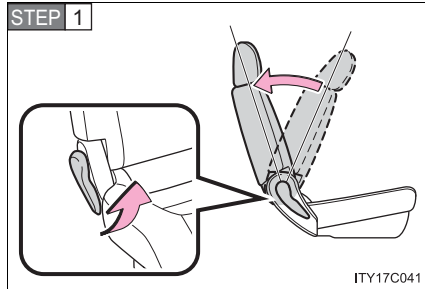

Fold the seatback while pulling the seatback angle lever. Return the seatback and secure it at the first lock position. (→P. 59)

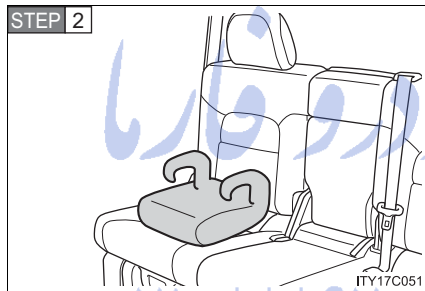

Place the child restraint system on the seat facing the front of the vehicle.

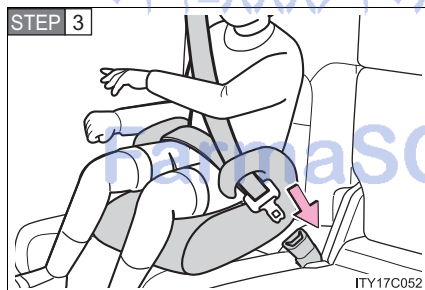

Sit the child in the child restraint system. Fit the seat belt to the child restraint system according to the manufacturer's instructions and insert the plate into the buckle. Make sure that the belt is not twisted.

Check that the shoulder belt is correctly positioned over the child's shoulder, and that the lap belt is as low as possible. (→P. 76)

1

Before driving

Removing a child restraint system installed with a seat belt

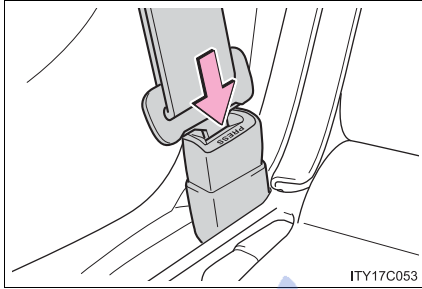

Press the buckle release button and fully retract the seat belt.

Child restraint systems with a top tether strap

STEP 1 Secure the child restraint system using a seat belt or LATCH anchors, and do the following.

► Outside

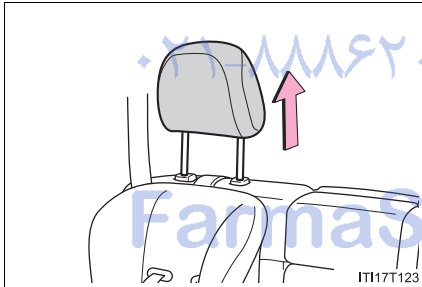

Adjust the head restraint to the upmost position.

► Center

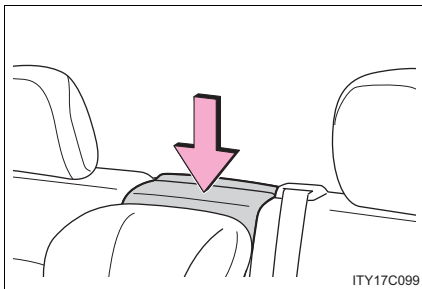

Lower the head restraint to the lowest position.

STEP 2 Open the anchor bracket cover, latch the hook onto the anchor bracket and tighten the top tether strap.

► Outside

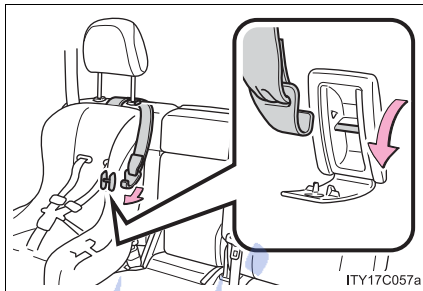

Make sure the top tether strap is securely latched.

1

Before driving

► Center

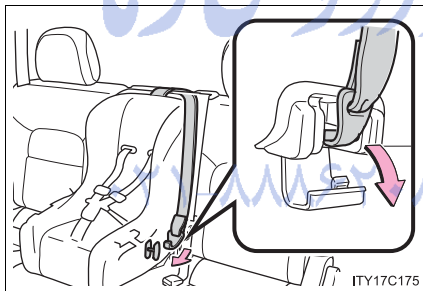

STEP 3

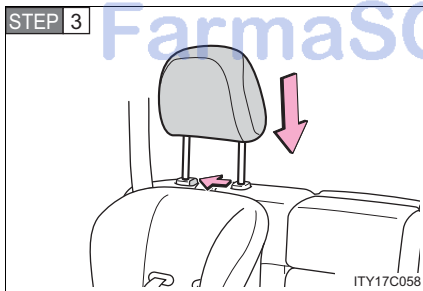

Outside only: Adjust the head restraint to the downmost position.

1-7. Safety information

■ Laws and regulations pertaining to anchorages

The LATCH system conforms to FMVSS225.

Child restraint systems conforming to FMVSS213 specifications can be used.

This vehicle is designed to conform to the SAE J1819.

⚠ CAUTION

■ When installing a booster seat

Do not fully extend the shoulder belt to prevent the belt from going to ALR lock mode: (→P. 80)

ALR mode causes the belt to tighten only which could cause injury or discomfort to the child.

تلفن شبانه روزی: ۰۲۱-۸۸۶۲۰۸۵

FarmaSOS.com

! CAUTION**■ When installing a child restraint system**

Follow the directions given in the child restraint system installation manual and fix the child restraint system securely in place.

If the child restraint system is not correctly fixed in place, the child or other passengers may be seriously injured or even killed in the event of sudden braking, sudden swerving or an accident.

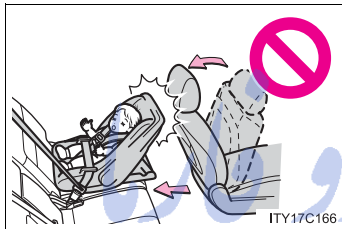

- If the driver's seat interferes with the child restraint system and prevents it from being attached correctly, attach the child restraint system to the right-hand rear seat.

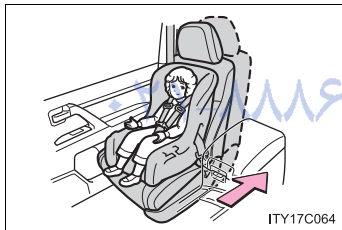

- Child restraint system installed on the third seat should not contact the second seatbacks.

- Only put a forward-facing child restraint system on the front seat when unavoidable. When installing a forward-facing child restraint system on the front passenger seat, move the seat as far back as possible even if the AIR BAG OFF indicator light illuminates. Failing to do so may result in death or serious injury if the airbags deploy (inflate).

- When using the LATCH anchors for a child restraint system, move the seat as far as possible and adjust the seatback as upright as possible, with the seatback close to the child restraint system.

- When a booster seat is installed, always ensure that the shoulder belt is positioned across the center of the child's shoulder. The belt should be kept away from the child's neck, but not so that it could fall off the child's shoulder. Failing to do so may result in death or serious injury in the event of sudden braking, sudden swerving or an accident.

1

Before driving

 CAUTION

■ **When installing a child restraint system**

- Ensure that the belt and tab are securely locked and the seat belt is not twisted.
- Shake the child restraint left and right, and forward and back to ensure that it has been securely installed.
- After securing a child restraint system, never adjust the seat.
- Follow all installation instructions provided by the child restraint system manufacturer.

■ **Do not use a seat belt extender**

If a seat belt extender is used when installing a child restraint system, the seat belt will not securely hold the child restraint system, which could cause death or serious injury to the child or other passengers in the event of sudden braking, sudden swerving or an accident.

■ **To correctly attach a child restraint system to the anchors**

When using the LATCH anchors, be sure that there are no foreign objects around the anchors and that the seat belt is not caught behind the child restraint system. Make sure the child restraint system is securely attached, or it may cause death or serious injury to the child or other passengers in the event of a sudden stop, sudden swerve or accident.

FarmaSOS.com

2-1. Driving procedures

Driving the vehicle..... 154
 Engine (ignition) switch..... 166
 Automatic transmission..... 171
 Turn signal lever 176
 Parking brake..... 177
 Horn 178

2-2. Instrument cluster

Gauges and meters 179
 Indicators and warning lights 184
 Multi-information display..... 189

2-3. Operating the lights and wipers

Headlight switch..... 196
 Fog light switch 201
 Windshield wipers and washer 202
 Rear window wiper and washer 208
 Headlight cleaner switch..... 209

2-4. Using other driving systems

Cruise control..... 210
 Dynamic radar cruise control 214
 Intuitive parking assist..... 229
 Four-wheel drive system 240
 Crawl Control (with Turn Assist function) 245
 Multi-terrain Select 251
 Multi-terrain Monitor 257
 Driving assist systems 281
 Pre-Collision System..... 289

2-5. Driving information

Off-road precautions 296
 Cargo and luggage 301
 Vehicle load limits 308
 Winter driving tips 309
 Trailer towing 314
 Dinghy towing 332

2-1. Driving procedures

Driving the vehicle

The following procedures should be observed to ensure safe driving.

■ Starting the engine (→P. 166)

■ Driving

STEP 1 With the brake pedal depressed, shift the shift lever to “D”.
(→P. 171)

STEP 2 Release the parking brake.
(→P. 177)

STEP 3 Gradually release the brake pedal and gently push the accelerator pedal to accelerate the vehicle.

■ Stopping

STEP 1 With the shift lever in “D”, push the brake pedal.

STEP 2 If necessary, set the parking brake.

When the vehicle is stopped for an extended period of time, shift the shift lever to “P” or “N”.
(→P. 171)

■ Parking the vehicle

STEP 1 With the shift lever in “D”, push the brake pedal.

STEP 2 Set the parking brake.
(→P. 177)

STEP 3 Shift the shift lever to “P”.
(→P. 171)

When parking on a hill, if necessary, block the wheels.

STEP 4 Press the “ENGINE START STOP” switch to stop the engine.

STEP 5 Lock the door, making sure that you have the key on your person.

Starting on a steep incline

STEP 1 Firmly set the parking brake and shift the shift lever to “D”.

STEP 2 Gently depress the accelerator pedal.

STEP 3 Release the parking brake.

■ Driving in the rain

- Drive carefully when it is raining, because visibility will be reduced, the windows may become fogged-up, and the road will be slippery.
- Drive carefully when it starts to rain, because the road surface will be especially slippery.
- Refrain from high speeds when driving on an expressway in the rain, because there may be a layer of water between the tires and the road surface, preventing the steering and brakes from operating properly.

■ Engine speed while driving

In the following conditions, the engine speed may become high while driving. This is due to automatic up-shifting control or down-shifting implementation to meet driving conditions. It does not indicate sudden acceleration.

- The vehicle is judged to be driving uphill or downhill
- When the accelerator pedal is released
- When the brake pedal is depressed while power mode is selected (→P. 172)

■ Breaking in your new Toyota

To extend the life of the vehicle, the following precautions are recommended to observe:

- For the first 200 miles (300 km):
Avoid sudden stops.
- For the first 500 miles (800 km):
Do not tow a trailer.
- For the first 1000 miles (1600 km):
 - Do not drive at extremely high speeds.
 - Avoid sudden acceleration.
 - Do not drive continuously in the low gears.
 - Do not drive at a constant speed for extended periods.

■ Drum-in-disc type parking brake system

Your vehicle has a drum-in-disc type parking brake system. This type of brake system needs bedding-down of the brake shoes periodically or whenever the parking brake shoes and/or drums are replaced. Have your Toyota dealer perform the bedding down operation.

■ Operating your vehicle in a foreign country

Comply with the relevant vehicle registration laws and confirm the availability of the correct fuel. (→P. 670)

■ Eco Driving Indicator

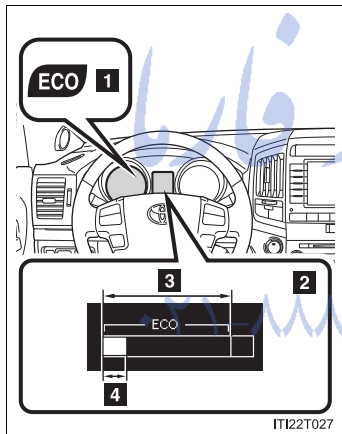

- 1** Eco Driving Indicator Light
During Eco-friendly acceleration (Eco driving), Eco Driving Indicator Light will turn on.
- 2** Eco Driving Indicator Zone Display
Suggests Zone of Eco driving with current Eco driving ratio based on acceleration.
- 3** Zone of Eco driving
- 4** Eco driving ratio based on acceleration
If the vehicle exceeds Zone of Eco driving, the right side of Eco Driving Indicator Zone Display will blink and Eco Driving Indicator Light will turn off.

Eco Driving Indicator Light will not operate in the following conditions:

- The shift lever is in anything other than "D".
- The vehicle is set to second start mode or power mode. (→P. 172)
- The vehicle speed is approximately 81 mph (130 km/h) or higher.
- The Crawl Control is operating. (→P. 245)

■ When turning off the engine

Emission system operating sounds may continue for a short time after the engine is turned off. This is not a malfunction, and helps to ensure optimal performance of the emission system.

⚠ CAUTION

■ When starting the vehicle

Always keep your foot on the brake pedal while stopped with the engine running. This prevents the vehicle from creeping.

■ When driving the vehicle

- Do not drive if you are unfamiliar with the location of the brake and accelerator pedals to avoid depressing the wrong pedal.
 - Accidentally depressing the accelerator pedal instead of the brake pedal will result in sudden acceleration that may lead to an accident that could result in death or serious injury.
 - When backing up, you may twist your body around, leading to a difficulty in operating the pedals. Make sure to operate the pedals properly.
 - Make sure to keep a correct driving posture even when moving the vehicle only slightly, allowing you to depress the brake and accelerator pedals properly.
 - Depress the brake pedal using your right foot. Depressing the brake pedal using your left foot may delay response in an emergency, resulting in an accident.
- Do not drive the vehicle over or stop the vehicle near flammable materials. The exhaust system and exhaust gases can be extremely hot. This may cause a fire if there is any flammable material nearby.
- Do not let the vehicle roll backwards while the shift lever is in a driving position, or roll forward while the shift lever is in "R". Doing so may cause the engine to stall and lead to poor steering performance, resulting in an accident or damage to the vehicle.
- If the smell of exhaust is noticed inside the vehicle, open the windows and check that the back door is closed. Large amounts of exhaust in the vehicle can cause driver drowsiness and an accident, resulting in death or a serious health hazard. Have the vehicle inspected by your Toyota dealer immediately.

 CAUTION

- Do not shift the shift lever to “P” while the vehicle is moving.
Doing so can damage the transmission and may result in a loss of vehicle control.
- Do not shift the shift lever to “R” while the vehicle is moving forward.
Doing so can damage the transmission and may result in a loss of vehicle control.
- Do not shift the shift lever to “D” while the vehicle is moving backward.
Doing so can damage the transmission and may result in a loss of vehicle control.
- Moving the shift lever to “N” while the vehicle is moving will disengage the engine from the transmission. Engine braking is not available when “N” is selected.
- During normal driving, do not turn off the engine. Turning the engine off while driving will not cause loss of steering or braking control, but the power assist to these systems will be lost. This will make it more difficult to steer and brake, so you should pull over and stop the vehicle as soon as it is safe to do so.
However, in the event of an emergency, such as if it becomes impossible to stop the vehicle in the normal way: →P. 664
- Use engine braking (downshift) to maintain a safe speed when driving down a steep hill.
Using the brakes continuously may cause the brakes to overheat and lose effectiveness. (→P. 171)
- When stopped on an inclined surface, use the brake pedal and parking brake to prevent the vehicle from rolling backward or forward and causing an accident.
- Do not adjust the position of the steering wheel, the seat, or the inside or outside rear view mirrors while driving.
Doing so may result in a loss of vehicle control that can cause accidents that may result in death or serious injury.
- Always check that all passengers’ arms, heads or other parts of their bodies are not outside the vehicle, as this may result in death or serious injury.

⚠ CAUTION

- Do not drive in excess of the speed limit. Even if the legal speed limit permits it, do not drive over 85 mph (140 km/h) unless your vehicle has high-speed capability tires. Driving over 85 mph (140 km/h) may result in tire failure, loss of control and possible injury. Be sure to consult a tire dealer to determine whether the tires on your vehicle are high-speed capability tires or not before driving at such speeds.

■ When driving on slippery road surfaces

- Sudden braking, acceleration and steering may cause tire slippage and reduce your ability to control the vehicle, resulting in an accident.
- Sudden acceleration, engine braking due to shift changing, or changes in engine speed could cause the vehicle to skid, resulting in an accident.
- After driving through a puddle, lightly depress the brake pedal to make sure that the brakes are functioning properly. Wet brake pads may prevent the brakes from functioning properly. If the brakes on only one side are wet and not functioning properly, steering control may be affected, resulting in an accident.

■ When shifting the shift lever

Be careful not to shift the shift lever with the accelerator pedal depressed. This may lead to unexpected rapid acceleration of the vehicle that may cause an accident and result in death or serious injury.

■ If you hear a squealing or scraping noise (brake pad wear limit indicators)

Have your Toyota dealer check and replace the brake pads as soon as possible.

Rotor damage may result if the pads are not replaced when needed.

It is dangerous to drive the vehicle when the wear limits of the brake pads and/or those of the rotors are exceeded.

 CAUTION

■ **When the vehicle is stopped**

- Do not race the engine.
If the vehicle is in any gear other than “P” or “N”, the vehicle may accelerate suddenly and unexpectedly, and may cause an accident.
- Do not leave the vehicle with the engine running for a long time.
If such a situation cannot be avoided, park the vehicle in an open space and check that exhaust fumes do not enter the vehicle interior.
- In order to prevent accidents due to the vehicle rolling away, always keep depressing the brake pedal while the engine is running, and apply the parking brake as necessary.
- If the vehicle is stopped on an incline, in order to prevent accidents caused by the vehicle rolling forward or backward, always depress the brake pedal and securely apply the parking brake as needed.
- Avoid revving or racing the engine.
Running the engine at high speed while the vehicle is stopped may cause the exhaust system to overheat, which could result in a fire if combustible material is nearby.

تلفن شبانه روزی: ۰۲۱-۸۸۶۲۰۸۵

FarmaSOS.com

⚠ CAUTION**■ When the vehicle is parked**

- Do not leave glasses, cigarette lighters, spray cans, or soft drink cans in the vehicle when it is in the sun.
Failure to do so may result in the following:
 - Gas may leak from a cigarette lighter or spray can, and may lead to a fire.
 - The temperature inside the vehicle may cause the plastic lenses and plastic material of eye glasses to deform or crack.
 - Soft drink cans may fracture, causing the contents to spray over the interior of the vehicle, and may also cause a short circuit in the vehicle's electrical components.
- Always apply the parking brake, shift the shift lever to "P", stop the engine and lock the vehicle.
Do not leave the vehicle unattended while the engine is running.
- If the shift lever is moved before the low speed four-wheel drive indicator turns on/off, the transfer mode may not be shifted completely. The transfer mode disengages both the front and rear driveshafts from the powertrain and allows the vehicle to move regardless of the shift position. (At this time, the indicator blinks and the buzzer sounds.)
Therefore, the vehicle is free to roll even if the automatic transmission is in "P". You or someone else could be seriously injured. You must complete the shifting of the transfer mode. (→P. 240)
- Do not touch the exhaust pipe while the engine is running or immediately after turning the engine off.
Doing so may cause burns.
- Do not leave the engine running in an area with snow build-up, or where it is snowing. If snowbanks build up around the vehicle while the engine is running, exhaust gases may collect and enter the vehicle. This may lead to death or a serious health hazard.

 CAUTION

■ **Exhaust gases**

Exhaust gases include harmful carbon monoxide (CO) that is colorless and odorless. Inhaling exhaust gases may lead to death or a serious health hazard.

- If the vehicle is in a poorly ventilated area, stop the engine. In a closed area, such as a garage, exhaust gases may collect and enter the vehicle. This may lead to death or a serious health hazard.
- The exhaust should be checked occasionally. If there is a hole or crack caused by corrosion, damage to a joint or abnormal exhaust noise, be sure to have the vehicle inspected and repaired by your Toyota dealer. Failure to do so may allow exhaust gases to enter the vehicle, resulting in death or a serious health hazard.

■ **When taking a nap in the vehicle**

Always turn the engine off. Otherwise, you may accidentally move the shift lever or depress the accelerator pedal, which could cause an accident or fire due to engine overheating. Additionally, if the vehicle is parked in a poorly ventilated area, exhaust gases may collect and enter the vehicle, leading to death or a serious health hazard.

FarmaSOS.com

⚠ CAUTION**■ When braking the vehicle**

- When the brakes are wet, drive more cautiously.
Braking distance increases when the brakes are wet, and may cause one side of the vehicle to brake differently than the other side. Also the parking brake may not securely hold the vehicle.
- If the power brake assist function does not operate, do not follow other vehicles closely and avoid hills or sharp turns that require braking.
In this case, braking is still possible, but the brake pedal should be depressed more firmly than usual. Also, the braking distance will increase. Have your brakes fixed immediately.
- Do not pump the brake pedal if the engine stalls.
Each push on the brake pedal uses up the reserve for the power-assisted brakes.
- The brake system consists of 2 individual hydraulic systems: if one of the systems fails, the other will still operate. In this case, the brake pedal should be depressed more firmly than usual and the braking distance will increase.
Have your brakes fixed immediately.

2

When driving

FarmaSOS.com

2-1. Driving procedures

NOTICE

■ While driving the vehicle

- Do not depress the accelerator and brake pedals at the same time during driving, as this may restrain driving torque.
- Do not use the accelerator pedal or depress accelerator and brake pedals together to hold the vehicle on a hill.

■ When parking the vehicle

Always put the shift lever in "P". Failure to do so may cause the vehicle to move or the vehicle may accelerate suddenly if the accelerator pedal is accidentally depressed.

■ Avoiding damage to vehicle parts

- Do not turn the steering wheel fully in either direction and hold it there for a long time.
Doing so may damage the power steering pump.
- When driving over bumps in the road, drive as slowly as possible to avoid damaging the wheels, underside of the vehicle, etc.

تلفن شبانه روزی: ۰۲۱-۸۸۸۶۲۰۸۵

FarmaSOS.com

 NOTICE

■ **If you get a flat tire while driving**

A flat or damaged tire may cause the following situations. Hold the steering wheel firmly and gradually press the brake pedal to slow down the vehicle.

- It may be difficult to control your vehicle.
- The vehicle will make abnormal sounds.
- The vehicle will behave abnormally.

Replace a flat tire with a new one. (→P. 635)

■ **When encountering flooded roads**

Do not drive on a road that has flooded after heavy rain etc. Doing so may cause the following serious damage to the vehicle.

- Engine stalling
- Short in electrical components
- Engine damage caused by water immersion

In the event that you drive on a flooded road and the vehicle is flooded, be sure to have your Toyota dealer check the following.

- Brake function
- Changes in quantity and quality of oil and fluid used for the engine, transmission, transfer, differentials, etc.
- Lubricant condition for the propeller shaft, bearings and suspension joints (where possible) and the function of all joints, bearings, etc.

2-1. Driving procedures Engine (ignition) switch

Performing the following operations when carrying the electronic key on your person starts the engine or changes “ENGINE START STOP” switch modes.

■ Starting the engine

STEP 1 Check that the parking brake is set.

STEP 2 Check that the shift lever is set in “P”.

STEP 3 Sit in the driver’s seat and firmly depress the brake pedal.

The “ENGINE START STOP” switch indicator turns green.

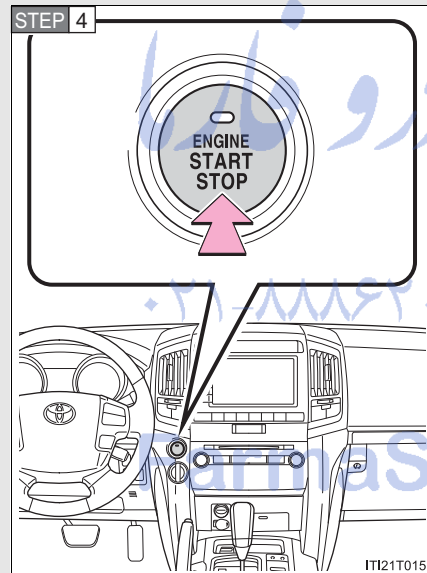

Press the “ENGINE START STOP” switch.

The engine can be started from any “ENGINE START STOP” switch mode.

Continue depressing the brake pedal until the engine is completely started. The engine will crank until it starts or for up to 30 seconds, whichever is less.

■ Changing “ENGINE START STOP” switch mode

Modes can be changed by pressing the “ENGINE START STOP” switch with the brake pedal released. (The mode changes each time the switch is pressed.)

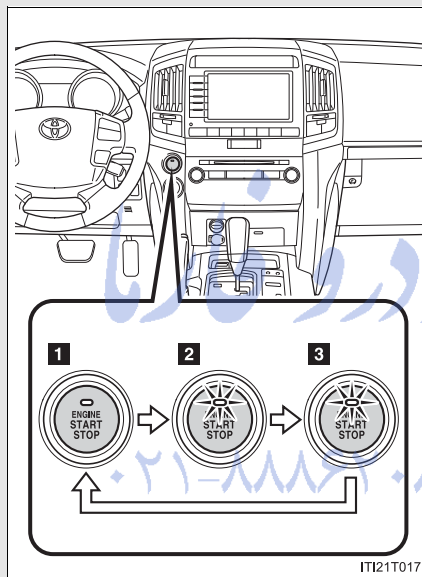

1 OFF*

Emergency flashers can be used.

2 ACCESSORY mode

Some electrical components such as the audio system can be used.

The “ENGINE START STOP” switch indicator turns amber.

3 IGNITION ON mode

All electrical components can be used.

The “ENGINE START STOP” switch indicator turns amber.

*: If the shift lever is in a position other than “P” when turning off the engine, the “ENGINE START STOP” switch will be turned to ACCESSORY mode, not to OFF.

■ **Operation of the “ENGINE START STOP” switch**

When operating the “ENGINE START STOP” switch, one short, firm press is enough. If the switch is pressed improperly, the engine may not start or the “ENGINE START STOP” switch mode may not change. It is not necessary to press and hold the switch.

■ **When the steering lock cannot be released**

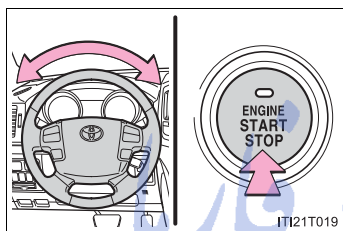

The green indicator light on the “ENGINE START STOP” switch will flash and a message will be shown on the multi-information display. Press the “ENGINE START STOP” switch again while turning the steering wheel left and right.

■ **If the engine does not start**

The engine immobilizer system may not have been deactivated. (→P. 105)
Contact your Toyota dealer.

■ **When the “ENGINE START STOP” switch indicator flashes in amber**

The system may be malfunctioning. Have the vehicle inspected by your Toyota dealer immediately.

FarmaSOS.com

■ **Auto power off function**

If the vehicle is left in ACCESSORY mode for more than 20 minutes with the shift lever in P, the “ENGINE START STOP” switch will automatically turn off. However, this function cannot entirely prevent battery discharge. Do not leave the vehicle with the “ENGINE START STOP” switch in ACCESSORY mode for long periods of time when the engine is not running.

■ **Electronic key battery depletion**

→P. 38

■ **When the electronic key battery is discharged**

→P. 653

■ **Conditions affecting operation**

→P. 36

■ **Note for the smart key system**

→P. 39

امداد خودرو مارا
تلفن شبانه روزی: ۰۲۱-۸۸۶۲۰۸۵

FarmaSOS.com

 CAUTION

■ **When starting the engine**

Always start the engine while sitting in the driver's seat. Do not depress the accelerator pedal while starting the engine under any circumstances. Doing so may cause an accident resulting in death or serious injury.

■ **Stopping the engine in an emergency**

If you want to stop the engine in an emergency while driving the vehicle, press and hold the "ENGINE START STOP" switch for more than 2 seconds, or press it briefly 3 times or more in succession. (→P. 664)

However, do not touch the "ENGINE START STOP" switch while driving except in an emergency. Turning the engine off while driving will not cause loss of steering or braking control, but the power assist to these systems will be lost. This will make it more difficult to steer and brake, so you should pull over and stop the vehicle as soon as it is safe to do so.

 NOTICE

■ **To prevent battery discharge**

Do not leave the "ENGINE START STOP" switch in ACCESSORY or IGNITION ON mode for long periods without the engine running.

■ **When starting the engine**

- Do not race a cold engine.
- If the engine becomes difficult to start or stalls frequently, have your vehicle checked by your Toyota dealer immediately.

■ **Symptoms indicating a malfunction with the "ENGINE START STOP" switch**

If the "ENGINE START STOP" seems to be operating somewhat differently than usual, such as the switch sticking slightly, there may be a malfunction. Contact your Toyota dealer immediately.

2-1. Driving procedures Automatic transmission

Select a shift position appropriate for the driving conditions.

■ Shifting the shift lever

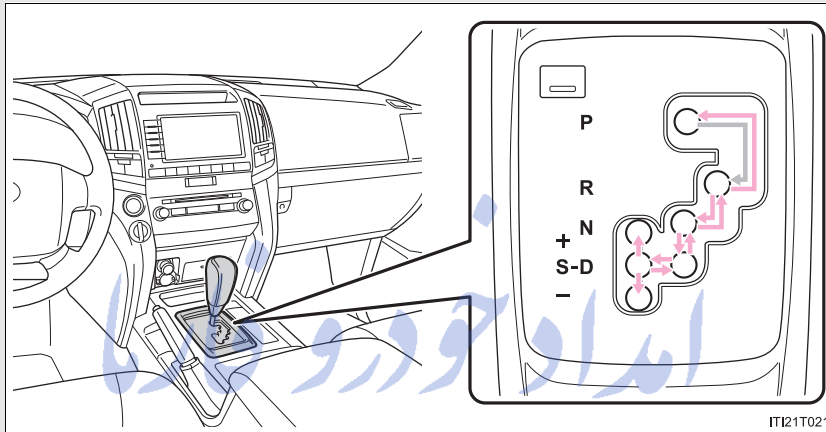

← While the “ENGINE START STOP” switch is in IGNITION ON mode, depress the brake pedal and move the shift lever.

■ Shift position uses

Shift position	Function
P	Parking the vehicle or starting the engine
R	Reversing
N	Condition in which the power is not transmitted
D	Normal driving ^{*1}
S	“S” mode driving ^{*2} (→P. 173)

^{*1}: Shifting to the “D” position allows the system to select a gear suitable for the driving conditions. Setting the shift lever to the “D” position is recommended for normal driving.

^{*2}: Selecting shift ranges using “S” mode restricts the upper limit of the possible gear ranges, controls engine braking forces, and prevents unnecessary upshifting.

2

When driving

■ Selecting a driving mode

The following patterns can be selected to suit current driving and operating conditions.

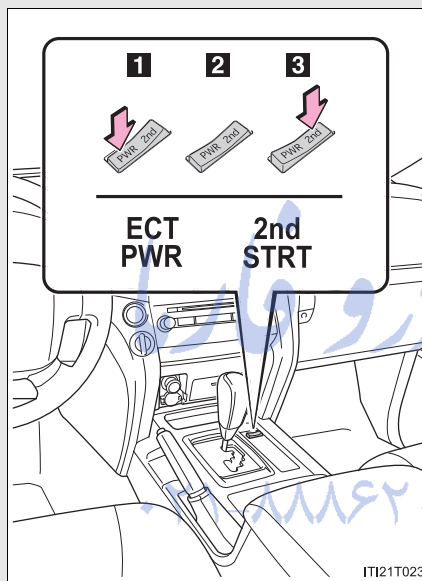

1 Power mode

For powerful acceleration and driving in mountainous regions.

2 Normal mode

For normal driving.

3 Second start mode

For starting on slippery road surfaces, such as on snow.

Press "2nd" to return to normal mode.

Changing shift ranges in “S” mode

Shift the shift lever to the “S” position and operate the shift lever.

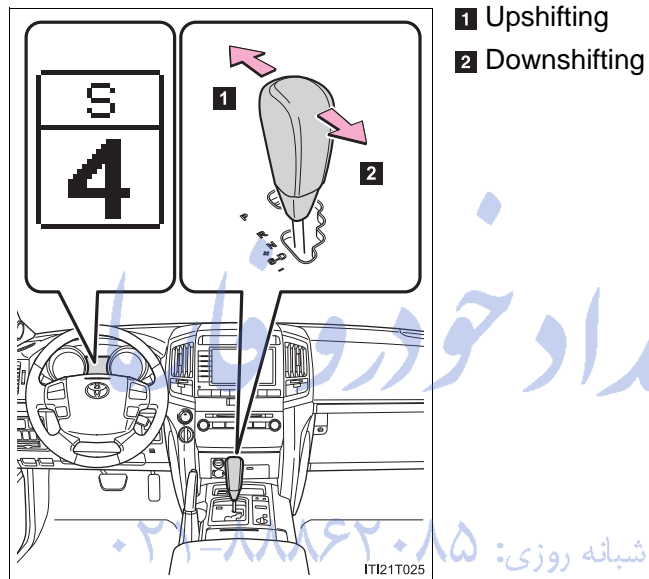

The initial shift range in “S” mode is automatically set to “5” or “4” according to the vehicle’s speed. However, the initial shift range may be set to “3” or “2” if the AI-SHIFT was operated while the shift lever was in the “D” position. (→P. 175)

2

When driving

■ **Shift ranges and their functions**

- Automatically selecting gears between 1 and 6 according to vehicle speed and driving conditions. But, the gear is limited according to selected shift range.
- You can choose from 6 levels of engine braking force.
- A lower shift range will provide greater engine braking force than a higher shift range, and the engine revolutions will also increase.

■ **“S” mode**

- When the shift range is “5” or lower, holding the shift lever toward “+” sets the shift range to “6”.
- To prevent excessive engine speed, a function was adopted that automatically selects a higher shift range before the engine speed becomes too high.
- To protect the automatic transmission, a function is adopted that automatically selects a higher shift range when the fluid temperature is high.

■ **Downshifting restrictions warning buzzer (in the “S” mode)**

To help ensure safety and driving performance, downshifting operation may sometimes be restricted. In some circumstances, downshifting may not be possible even when the shift lever is operated. (The warning buzzer will sound twice.)

■ **When driving with the cruise control or radar cruise control activated**

Even when performing the following actions with the intent of enabling engine braking, engine braking will not activate because cruise control or radar cruise control will not be canceled.

- While driving in “S” mode, downshifting to “5” or “4”. (→P. 210, 214)
- When switching the driving mode to power mode while driving in “D” position. (→P. 172)

■ **Second start mode automatic deactivation**

Second start mode is automatically deactivated if the engine is turned off after driving in second start mode.

■ **If the shift lever cannot be shifted from “P”**

→P. 651

■ **If the “S” indicator does not come on even after shifting the shift lever to “S”**

This may indicate a malfunction in the automatic transmission system. Have the vehicle inspected by your Toyota dealer immediately.
(In this situation, the vehicle will operate as if the shift lever is in “D”.)

■ **AI-SHIFT**

The AI-SHIFT automatically shifts the gear to the suitable position according to the driver performance and driving conditions.
The AI-SHIFT automatically operates when the shift lever is in the “D” position. (Shifting the shift lever to the “S” position cancels the function.)

2

When driving

تلفن شبانه روزی: ۰۲۱-۸۸۶۲۰۸۵

FarmaSOS.com

2-1. Driving procedures

Turn signal lever

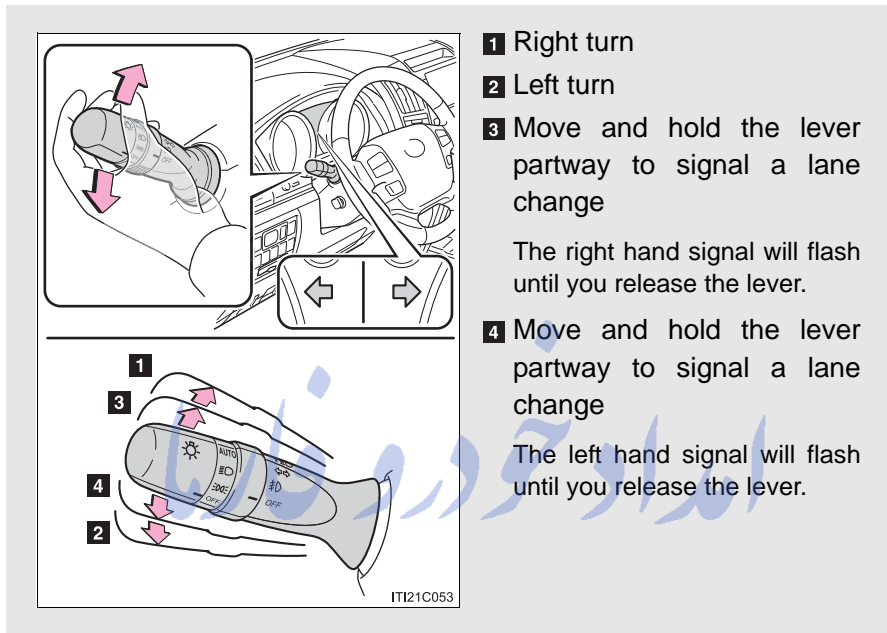

■ Turn signals can be operated when

The "ENGINE START STOP" switch is in IGNITION ON mode.

■ If the indicators flash faster than usual

Check that a light bulb in the front or rear turn signal lights has not burned out.

2-1. Driving procedures Parking brake



1 Sets the parking brake

Fully set the parking brake while depressing the brake pedal.

2 Releases the parking brake

Slightly raise the lever and lower it completely while pressing the button.

2

When driving

تلفن شماره روزی: ۰۲۱-۸۸۶۲۰۸۵

■ Usage in winter time

→P. 309

⚠ NOTICE

■ Before driving

Fully release the parking brake.

Driving the vehicle with the parking brake set will lead to brake components overheating, which may affect braking performance and increase brake wear.

2-1. Driving procedures

Horn

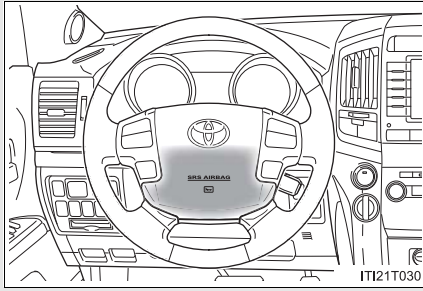

To sound the horn, press on or close to the  mark.

امداد خودرو فارما

تلفن شبانه روزی: ۰۲۱-۸۸۸۶۲۰۸۵

FarmaSOS.com

2-2. Instrument cluster Gauges and meters

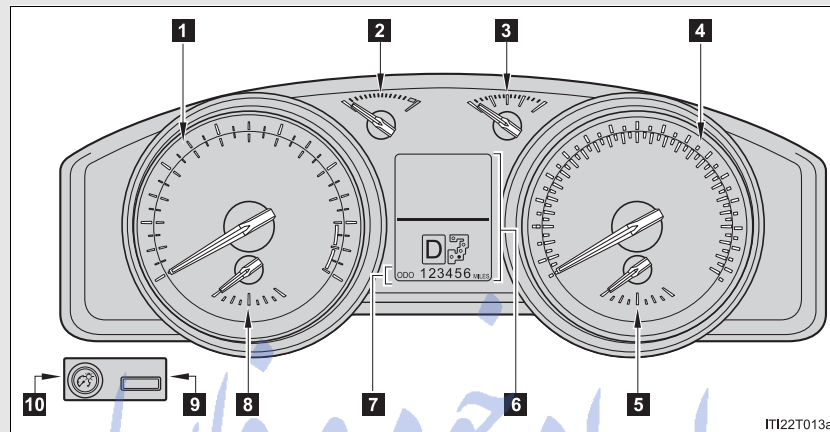

- 1 Tachometer**
Displays the engine speed in revolutions per minute
- 2 Engine coolant temperature gauge**
Displays the engine coolant temperature
- 3 Fuel gauge**
Displays the quantity of fuel remaining in the tank
- 4 Speedometer**
Displays the vehicle speed
- 5 Voltmeter**
Displays the charge state
- 6 Multi-information display**
Presents the driver with a variety of driving-related data
→P. 189

2

When driving

2-2. Instrument cluster

7 Odometer and trip meter

Odometer: Displays the total distance the vehicle has been driven

Trip meter: Displays the distance the vehicle has been driven since the meter was last reset. Trip meters A and B can be used to record and display different distances independently.

8 Engine oil pressure gauge

Displays the engine oil pressure

9 Odometer/trip meter display change button

Switches between odometer and trip meter displays

10 Instrument panel light control dial

The brightness of the instrument panel light can be adjusted

Switching the display

Pressing this button switches between odometer and trip meter.

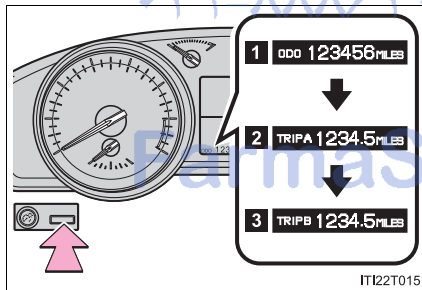

1 Odometer تلفن شبانه

2 Trip meter A*

3 Trip meter B*

*: Pushing and holding the button will reset the trip meter.

Eco Driving Indicator Light customization

Eco Driving Indicator Light can activated or deactivated.

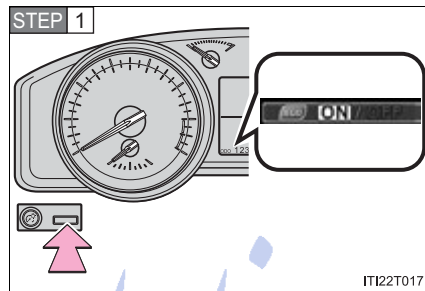

While the odometer is being displayed, press and hold the odometer/trip meter display change button to display the Eco Driving Indicator Light customization screen.

STEP 2 Press the odometer/trip meter display change button to set Eco Driving Indicator Light to on or off.

STEP 3 Press and hold the odometer/trip meter display change button to complete the setting.

2

When driving

تلفن شبانه روزی: ۰۲۱-۸۸۶۲۰۸۵

FarmaSOS.com

Instrument panel light control

The brightness of the instrument panel lights can be adjusted.

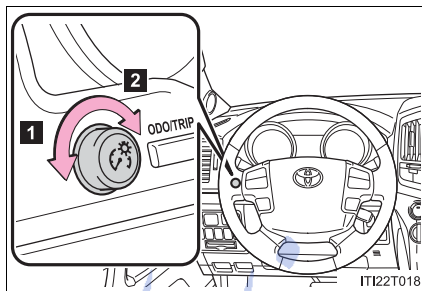

- 1 Darker
- 2 Brighter

■ The meters and display illuminate when

The "ENGINE START STOP" switch is in IGNITION ON mode.

■ The brightness of the instrument panel lights

When the tail lights are turned on, the meter's brightness will be reduced slightly unless the meter brightness level adjustment is set to the brightest setting.

If the tail lights are turned on when the surroundings are dark, the meter's brightness will reduce slightly. However, when the surroundings are bright, such as during the daytime, the meter's brightness will not be reduced even if the tail lights are turned on.

 NOTICE

■ **To prevent damage to the engine and its components**

- Do not let the indicator needle of the tachometer enter the red zone, which indicates the maximum engine speed.
- The engine may be overheating if the engine coolant temperature gauge is in the red zone ("H"). In this case, immediately stop the vehicle in a safe place, and check the engine after it has cooled completely. (→P. 659)

■ **Voltmeter**

When the voltmeter indicates 19 V or higher or 9 V or lower while the engine is running, there may be a battery or charging system malfunction. Have the vehicle inspected at your Toyota dealer.

■ **Engine oil pressure gauge**

When the value of the engine oil pressure gauge drops while the engine is running, stop the vehicle in a safe place immediately and check the amount of engine oil. (→P. 531)

When the oil pressure drops even though the engine oil amount has not decreased, or if the oil pressure does not increase when engine oil is added, contact your Toyota dealer, as there may be a problem with the lubrication system.

2

When driving

FarmaSOS.com

2-2. Instrument cluster Indicators and warning lights

The indicator and warning lights on the instrument cluster and center panel inform the driver of the status of the vehicle's various systems.

For the purpose of explanation, the following illustration displays all indicators and warning lights illuminated.

► Instrument cluster

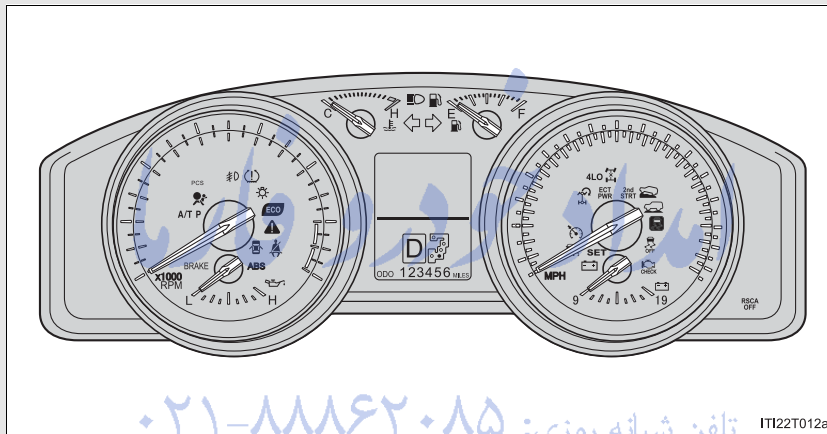

تلفن شبانه روزی: ۰۲۱-۸۸۸۶۲۰۸۵

FarmaSOS.com

► Center panel (vehicles with navigation system)

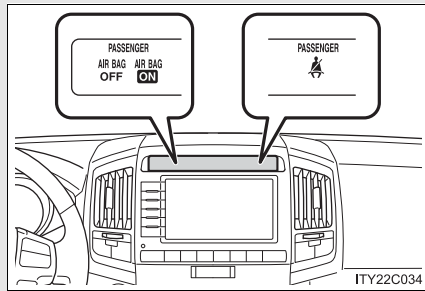

► Center panel (vehicles without navigation system)

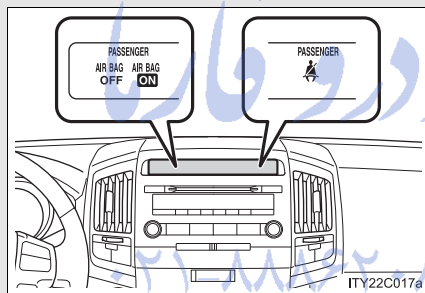



















FarmaSOS.com

2-2. Instrument cluster

■ Indicators

The indicators inform the driver of the operating state of the vehicle's various systems.

	Turn signal indicator (→P. 176)		Eco Driving Indicator Light (→P. 156)
	Headlight high beam indicator (→P. 197)		Roll sensing of curtain shield airbags off indica- tor (→P. 128)
	Headlight indicator (→P. 196)		"PWR" mode indicator (→P. 172)
	Fog light indicator (→P. 201)		Automatic transmission second start indicator (→P. 172)
	Cruise control indicator (→P. 210, 214)		Low speed four-wheel drive indicator light (→P. 240)
	^{*1, 2} Slip indicator (→P. 282)		Center differential lock indicator (→P. 240)
	^{*1} Crawl Control indicator (→P. 245)		^{*1} "AIR BAG ON/OFF" indicator (→P. 129)
	^{*1} VSC OFF indicator (→P. 283)		Dynamic radar cruise control indicator (→P. 214)
	"SET" indicator (→P. 210, 214)		Turn Assist function indicator (→P. 245)
	Multi-terrain Select indi- cator (→P. 251)		

*1: These lights turn on when the “ENGINE START STOP” switch is turned to IGNITION ON mode to indicate that a system check is being performed. They will turn off after the engine is started, or after a few seconds. There may be a malfunction in a system if a light does not come on, or if the lights do not turn off. Have the vehicle inspected by your Toyota dealer.

*2: The light flashes to indicate that the system is operating.

■ Warning lights

Warning lights inform the driver of malfunctions in the indicated vehicle’s systems. (→P. 608)

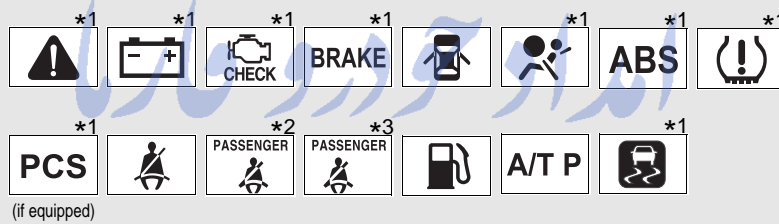

*1: These lights turn on when the “ENGINE START STOP” switch is turned to IGNITION ON mode to indicate that a system check is being performed. They will turn off after the engine is started, or after a few seconds. There may be a malfunction in a system if the lights do not come on, or if the lights do not turn off. Have the vehicle inspected by your Toyota dealer.

*2: Vehicles with navigation system

*3: Vehicles without navigation system

2-2. Instrument cluster

CAUTION

■ If a safety system warning light does not come on

Should a safety system light such as Multi Terrain ABS and the SRS airbag warning lights not come on when you start the engine, this could mean that these systems are not available to help protect you in an accident, which could result in death or serious injury. Have the vehicle inspected by your Toyota dealer immediately if this occurs.

امداد خودرو فارما

تلفن شبانه روزی: ۰۲۱-۸۸۸۶۲۰۸۵

FarmaSOS.com

2-2. Instrument cluster Multi-information display

The multi-information display presents the driver with a variety of driving-related data.

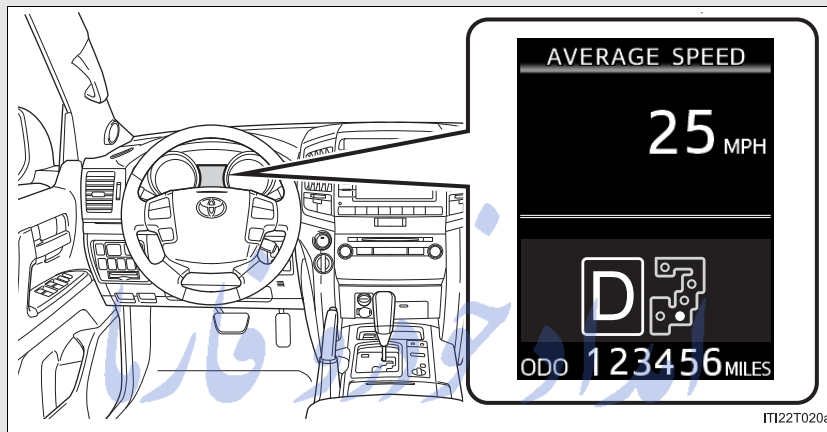

- Trip information (→P. 190)
Displays driving range, fuel consumption and other cruising related information.
- Speedometer (→P. 190)
- Turn-by-turn navigation (vehicles with a navigation system) (→P. 190)
- Front tire angle (→P. 190)
- Tire inflation pressure (→P. 190)
- Intuitive parking assist -sensor display (→P. 229)
Automatically displayed when using toyota parking assist-sensor.
- Dynamic radar cruise control display (if equipped) (→P. 214)
Automatically displayed when using dynamic radar cruise control.

2

When driving

2-2. Instrument cluster

- Multi-terrain Select display (→P. 251)
- Crawl Control display (→P. 245)
- Shift position and shift range (→P. 171)
Displays the selected shift position or selected shift range.
- Warning messages (→P. 619)
Automatically displayed when a malfunction occurs in one of the vehicle's system.

Switching the display

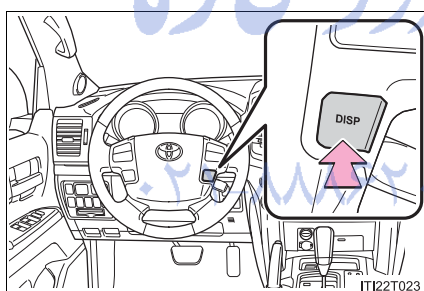

Display items can be switched by pressing the "DISP" switch.

Display items

- Average fuel consumption and Eco Driving Indicator Zone Display (→P. 156)

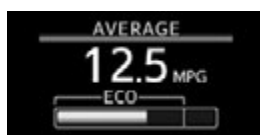

Displays the average fuel consumption since the function was reset

- The function can be reset by pressing the "DISP" switch for longer than 1 second when the average fuel consumption is displayed.
- Use the displayed average fuel consumption as a reference.

■ Average fuel consumption after refueling



Displays the average fuel consumption since the vehicle was last refueled

Use the displayed average fuel consumption as a reference.

■ Current fuel consumption



Displays the current rate of fuel consumption

■ Driving range



Displays the estimated maximum distance that can be driven with the quantity of fuel remaining

- This distance is computed based on your average fuel consumption. As a result, the actual distance that can be driven may differ from that displayed.
- When only a small amount of fuel is added to the tank, the display may not be updated.
When refueling, turn the "ENGINE START STOP" switch off. If the vehicle is refueled without turning the "ENGINE START STOP" switch off, the display may not be updated.

■ Speedometer



Displays the vehicle speed.

The speed units (MPH or km/h) can be selected by pressing the "DISP" switch for longer than 1 second when the speedometer is displayed.

2

When driving

2-2. Instrument cluster

■ Average vehicle speed



Displays the average vehicle speed since the engine was started or the function was reset

The function can be reset by pressing the "DISP" switch for longer than 1 second when the average vehicle speed is displayed.

■ Front tire angle



Displays the direction of the front tires

The tire direction is displayed in 3 stages for both left and right, in accordance with the angle of the tire.

■ Tire inflation pressure



Displays inflation pressure of each tire. There is no correlation between the order of the displayed values and the tire positions.

If the inflation pressure of any tire drops a certain amount below the tire inflation pressure value currently memorized in the system, the displayed values will be highlighted.

It may take a few minutes to display the tire inflation pressure after the "ENGINE START STOP" switch is turned to IGNITION ON mode. It may also take a few minutes to display the tire inflation pressure after inflation pressure has been adjusted.

If the tire pressure warning light is on or flashing, a message describing the situation will be displayed.

■ **Turn-by-turn navigation setting screen (vehicles with a navigation system)**



The turn-by-turn navigation can be set to on or off.

The function can be activated or deactivated by pressing the “DISP” switch for longer than 1 second when turn-by-turn navigation setting screen is displayed.

■ **Display off**

A blank screen is displayed

2

When driving

امداد خودرو فارما
تلفن شبانه روزی: ۰۲۱-۸۸۸۶۲۰۸۵

FarmaSOS.com

■ **System check display**

After turning the “ENGINE START STOP” switch to IGNITION ON mode, “LAND CRUISER” is displayed while system operation is checked. When the system check is complete, the normal screen will return.

■ **Turn-by-turn navigation (vehicles with navigation system)**

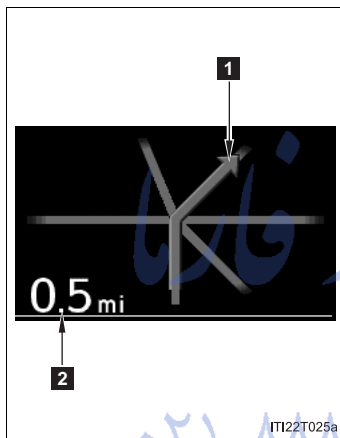

The turn-by-turn navigation appears only while route guidance of the navigation system is being performed. When a turn approaches, the distance to the turn and the turn direction are displayed.

- 1 Turn direction
- 2 Distance to the next turn

The image shown may differ from the actual intersection.

■ **When disconnecting and reconnecting battery terminals**

The following information data will be reset:

- Average fuel consumption after refueling
- Average fuel consumption
- Average vehicle speed

⚠ CAUTION**■ The information display at low temperatures**

Allow the interior of the vehicle to warm up before using the information display. At extremely low temperatures, the information display monitor may respond slowly, and display changes may be delayed.

For example, there is a lag between the driver's shifting and the new gear number appearing on the display. This lag could cause the driver to down-shift again, causing rapid and excessive engine braking and possibly an accident resulting in death or serious injury.

2

When driving

امداد خودرو فارما



تلفن شبانه روزی: ۰۲۱-۸۸۸۶۲۰۸۵

FarmaSOS.com

2-3. Operating the lights and wipers Headlight switch

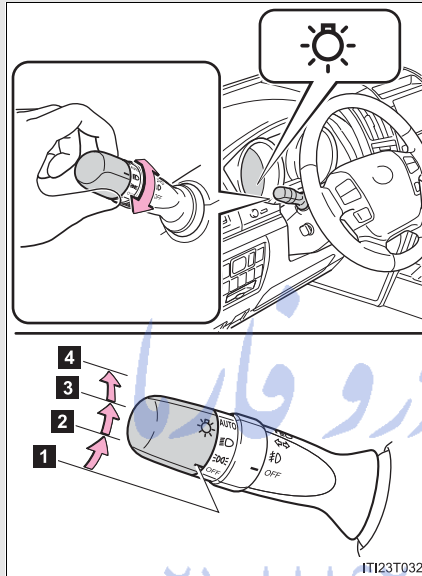
The headlights can be operated manually or automatically.



- 1 OFF** The daytime running lights turn on.
- 2**  The side marker, parking, tail, license plate, daytime running lights and instrument panel lights turn on.
- 3**  The headlights and all lights listed above (except daytime running lights) turn on.
- 4 AUTO** The headlights, daytime running lights and all lights listed above turn on and off automatically. (When the “ENGINE START STOP” switch is in IGNITION ON mode.)

Turning on the high beam headlights

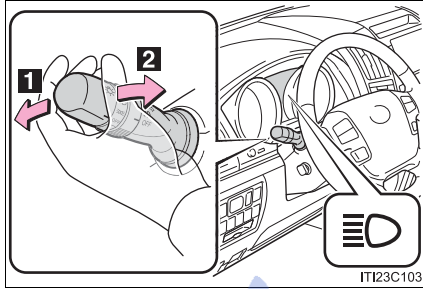

1 With the headlights on, push the lever forward to turn on the high beams.

Pull the lever back to the center position to turn the high beams off.

2 Pull the lever toward you to turn on the high beams.

Release the lever to turn them off. You can flash the high beams with the headlights on or off.

2

When driving

تلفن شبانه روزی: ۰۲۱-۸۸۸۶۲۰۸۵

FarmaSOS.com

Manual headlight leveling dial

The level of the headlights can be adjusted according to the number of passengers and the loading condition of the vehicle.

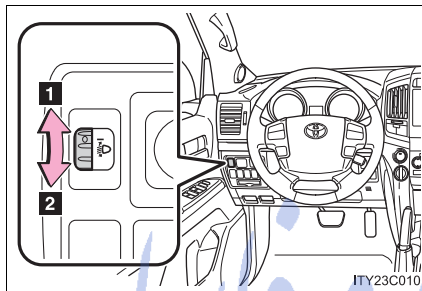

1 Raises the level of the headlights

2 Lowers the level of the headlights

■ Guide to dial settings

Occupancy and luggage load conditions		Dial position
Occupants	Luggage load	
Driver	None	0
Driver and front passenger	None	0
Driver, front passenger and all passengers in the rear seats farthest to the rear	None	1.5
All seats occupied	None	2
All seats occupied	Maximum load	2.5
Driver	Maximum load	3

■ **Daytime running light system**

- To make your vehicle more visible to other drivers, the headlights turn on automatically (at a reduced intensity) whenever the engine is started and the parking brake is released. Daytime running lights are not designed for use at night.
- Compared to turning on the headlights, the daytime running light system offers greater durability and consumes less electricity, so it can help improve fuel economy.

■ **Headlight control sensor**

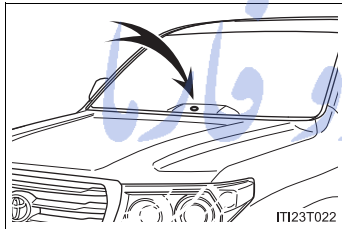

The sensor may not function properly if an object is placed on the sensor, or anything that blocks the sensor is affixed to the windshield. Doing so interferes with the sensor detecting the level of ambient light and may cause the automatic headlight system to malfunction.

2

When driving



تلفن شبانه روزی: ۰۲۱-۸۸۶۲۰۸۵

FarmaSOS.com

2-3. Operating the lights and wipers

■ Automatic light off system

- When the headlights are on: The headlights and tail lights turn off 30 seconds after a door is opened and closed if the “ENGINE START STOP” switch has been switched to ACCESSORY or OFF mode.
- When only the tail lights are on: The tail lights turn off automatically if the “ENGINE START STOP” switch is switched to ACCESSORY or OFF mode and driver’s door is opened.

To turn the lights on again, turn the “ENGINE START STOP” switch to IGNITION ON mode, or turn the light switch off once and then back to the  or  position.

■ Customization

Settings (e.g. light sensor sensitivity) can be changed.
(Customizable features → P. 694)

NOTICE

■ To prevent battery discharge

Do not leave the lights on longer than necessary when the engine is not running.

FarmaSOS.com

2-3. Operating the lights and wipers Fog light switch

The fog lights assist visibility in difficult driving conditions, such as in rain or fog. The fog lights can be used when the headlights are on low beam.

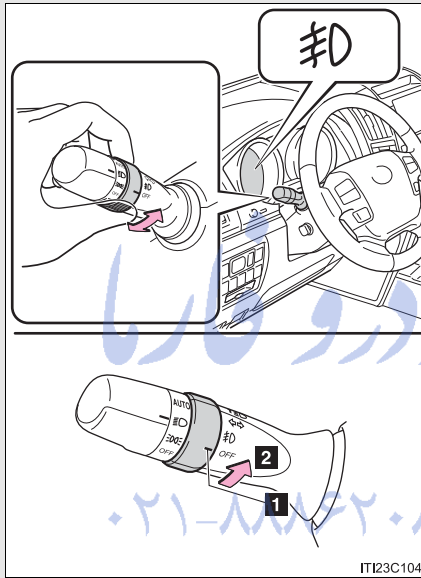

- 1 OFF** Turns the fog lights off
- 2 ☉** Turns the fog lights on

2

When driving

FarmaSOS.com

2-3. Operating the lights and wipers Windshield wipers and washer

► Intermittent windshield wipers with interval adjuster

The wiper operation is selected by moving the lever as follows. When intermittent windshield wiper operation is selected, the wiper interval can be also adjusted.

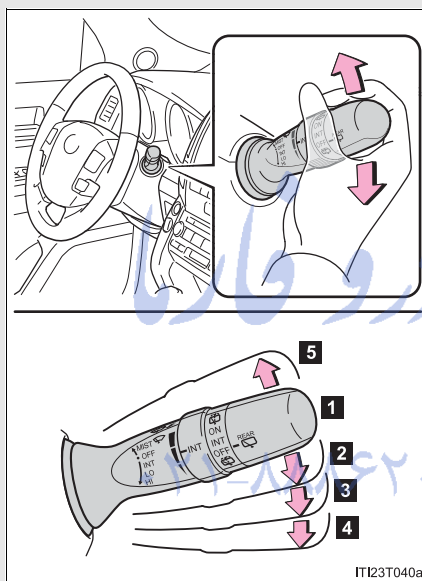

- 1 OFF** Off
- 2 INT** Intermittent windshield wiper operation
- 3 LO** Low speed windshield wiper operation
- 4 HI** High speed windshield wiper operation
- 5 MIST** Temporary operation

FarmaSOS.com

2-3. Operating the lights and wipers

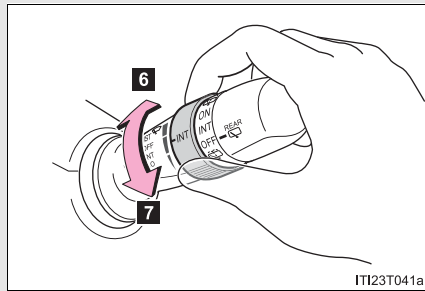

IT123T041a

- 6** Increases the intermittent windshield wiper frequency
- 7** Decreases the intermittent windshield wiper frequency

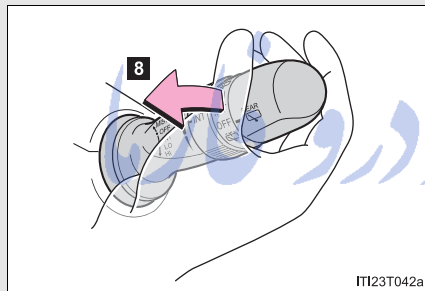

IT123T042a

- 8** Washer/wiper dual operation
The wipers will automatically operate a couple of times after the washer squirts.

2

When driving

تلفن شبانه روزی: ۰۲۱-۸۸۸۶۲۰۸۵

FarmaSOS.com

2-3. Operating the lights and wipers

► Rain-sensing windshield wipers

When "AUTO" is selected, the wipers will operate automatically when the sensor detects falling rain. The system automatically adjusts wiper timing in accordance with rain volume.

When "AUTO" is selected, the sensor sensitivity can be adjusted as follows by turning the switch ring:

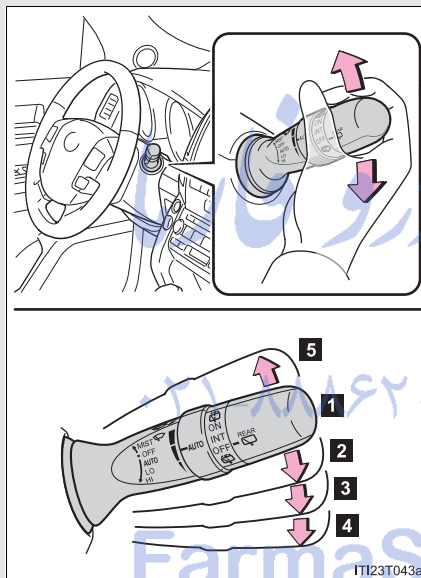

- 1 OFF** Off
- 2 AUTO** Rain-sensing wiper operation ("AUTO")
- 3 LO** Low speed wiper operation
- 4 HI** High speed wiper operation
- 5 MIST** Temporary operation

2-3. Operating the lights and wipers

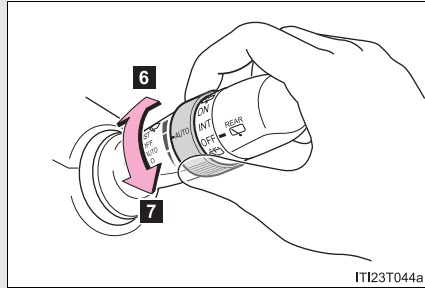

- 6** Increases the sensitivity
- 7** Decreases the sensitivity

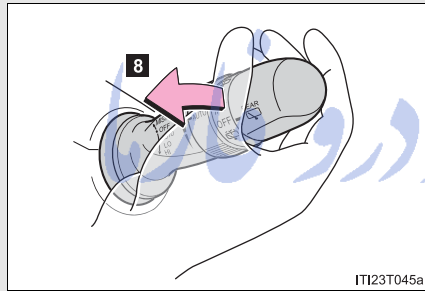

- 8** Washer/wiper dual operation

The wipers will automatically operate a couple of times after the washer squirts.

2

When driving

تلفن شبانه روزی: ۰۲۱-۸۸۸۶۲۰۸۵

FarmaSOS.com

2-3. Operating the lights and wipers

■ The windshield wiper and washer can be operated when

The "ENGINE START STOP" switch is in IGNITION ON mode.

■ Effects of vehicle speed on wiper operation (vehicles with rain-sensing windshield wipers)

Vehicle speed affects the wiper operation when the washer is being used (delay until drip prevention wiper sweep occurs) even when the wipers are not in "AUTO" mode.

With " LO " selected, wiper operation will be switched from low speed to intermittent wiper operation only when the vehicle is stationary. (However, when the sensor sensitivity is adjusted to the highest level, the mode cannot be switched.)

■ Rain drop sensor (vehicles with rain-sensing windshield wipers)

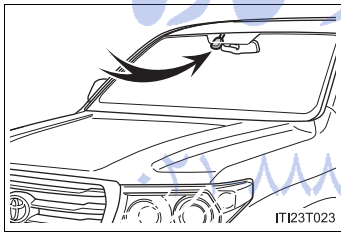

- The sensor judges the amount of rain-drops.

- If the wiper switch is turned to "AUTO" position while the "ENGINE START STOP" switch is in IGNITION ON mode, the wiper will operate once to show that "AUTO" mode is activated.
- If the temperature of the rain drop sensor is 176°F (80°C) or higher, or 14°F (-10°C) or lower, automatic operation may not occur. In this case, operate the wipers in any mode other than "AUTO".

■ If no windshield washer fluid sprays

Check that the washer nozzles are not blocked if there is washer fluid in the windshield washer fluid reservoir.

 CAUTION

■ **Caution regarding the use of windshield wipers in “AUTO” mode (vehicles with rain-sensing windshield wipers)**

The windshield wipers may operate unexpectedly if the sensor is touched or the windshield is subject to vibration in “AUTO” mode. Take care that your fingers or anything else do not become caught in the windshield wipers.

■ **Caution regarding the use of washer fluid**

When it is cold, do not use the washer fluid until the windshield becomes warm. The fluid may freeze on the windshield and cause low visibility. This may lead to an accident, resulting in death or serious injury.

 NOTICE

■ **When the windshield is dry**

Do not use the wipers, as they may damage the windshield.

■ **When there is no washer fluid spray from the nozzle**

Damage to the washer fluid pump may be caused if the lever is pulled toward you and held continually.

■ **When a nozzle becomes blocked**

Do not try to clear it with a pin or other object. The nozzle will be damaged.

2-3. Operating the lights and wipers

Rear window wiper and washer

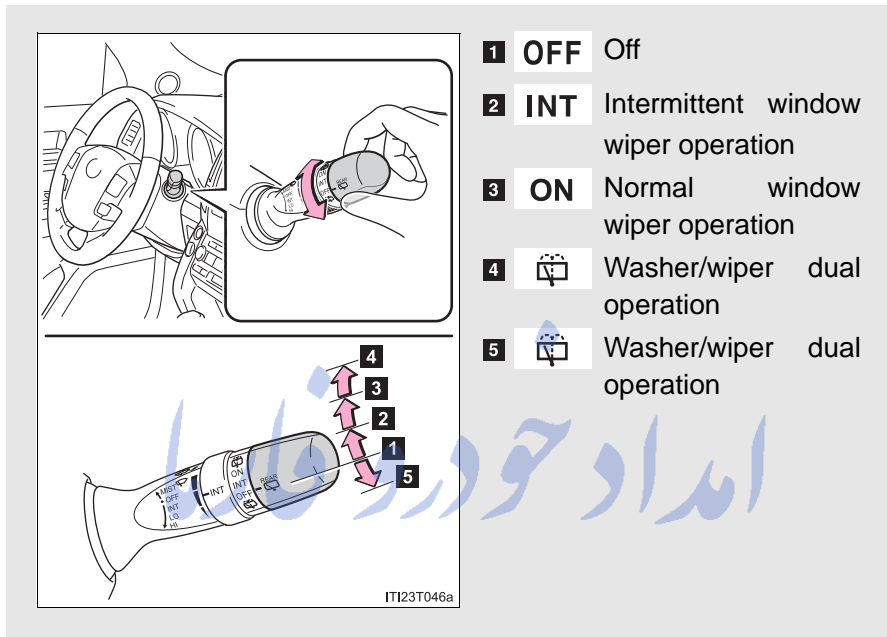

■ The rear window wiper and washer can be operated when

The "ENGINE START STOP" switch is in IGNITION ON mode.

NOTICE

■ When the rear window is dry

Do not use the wipers, as it may damage the rear window.

2-3. Operating the lights and wipers Headlight cleaner switch*

Washer fluid can be sprayed on the headlights.

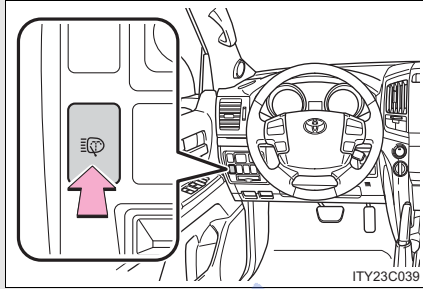

Press the switch to clean the headlights.

2

When driving

■ The headlight cleaner can be operated when

The "ENGINE START STOP" switch is in IGNITION ON mode and the headlight switch is turned on.

⚠ NOTICE

■ When the washer fluid tank is empty

Do not use this function when the washer fluid tank is empty. This may cause the washer fluid pump to overheat.

*: If equipped

209

2-4. Using other driving systems Cruise control*

Use the cruise control to maintain a set speed without depressing the accelerator pedal.

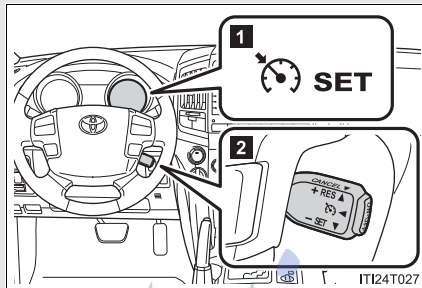

- 1 Indicators
- 2 Cruise control switch

■ Setting the vehicle speed

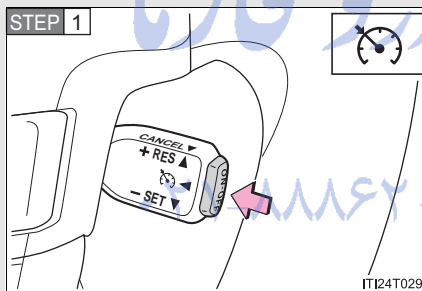

Press the "ON-OFF" button to activate the cruise control.

Cruise control indicator will come on.

Press the button again to deactivate the cruise control.

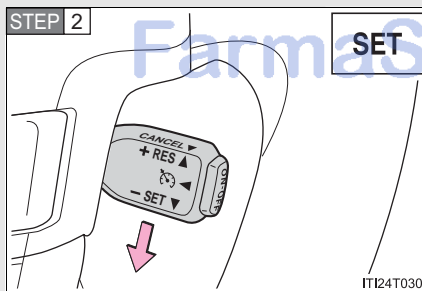

Accelerate or decelerate the vehicle to the desired speed, and push the lever down to set the speed.

"SET" indicator will come on.

The vehicle speed at the moment the lever is released becomes the set speed.

*: If equipped

■ **Adjusting the set speed**

To change the set speed, operate the lever until the desired set speed is obtained.

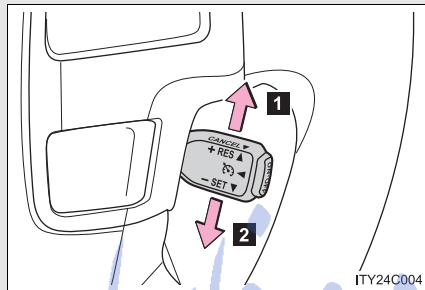

- 1 Increases the speed
- 2 Decreases the speed

Fine adjustment: Momentarily move the lever in the desired direction.

Large adjustment: Hold the lever in the desired direction.

The set speed will be increased or decreased as follows:

Fine adjustment: By approximately 1 mph (1.6 km/h) each time the lever is operated.

Large adjustment: The set speed can be increased or decreased continually until the lever is released.

■ **Canceling and resuming the constant speed control**

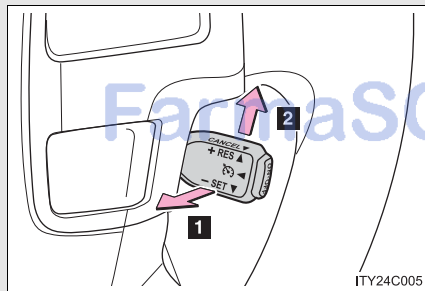

- 1 Pulling the lever toward you cancels the constant speed control.

The speed setting is also canceled when the brakes are applied.

- 2 Pushing the lever up resumes the constant speed control.

Resuming is available when the vehicle speed is more than approximately 25 mph (40 km/h).

■ **Cruise control can be set when**

- The shift lever is in the “D” or range “4” or higher of “S” has been selected.
- Vehicle speed is above approximately 25 mph (40 km/h).

■ **Accelerating after setting the vehicle speed**

- The vehicle can be accelerated normally. After acceleration, the set speed resumes.
- Even without canceling the cruise control, the set speed can be increased by first accelerating the vehicle to the desired speed and then pushing the lever down to set the new speed.

■ **Automatic cruise control cancelation**

Cruise control will stop maintaining the vehicle speed in any of the following situations.

- Actual vehicle speed falls more than approximately 10 mph (16 km/h) below the preset vehicle speed.
At this time, the memorized set speed is not retained.
- VSC is activated.
- Actual vehicle speed is below approximately 25 mph (40 km/h).
- The switching operation continues for 5 seconds or more after the center differential lock switch has been operated.

■ **If the warning message for the cruise control is shown on the multi-information display**

Press the “ON-OFF” button once to deactivate the system, and then press the button again to reactivate the system.

If the cruise control speed cannot be set or if the cruise control cancels immediately after being activated, there may be a malfunction in the cruise control system. Have the vehicle inspected by your Toyota dealer.

⚠ CAUTION

■ **To avoid operating the cruise control by mistake**

Switch the cruise control off using the “ON-OFF” button when not in use.

■ **Situations unsuitable for cruise control**

Do not use cruise control in any of the following situations. Doing so may result in loss of control and could cause an accident resulting in death or serious injury.

- In heavy traffic
- On roads with sharp bends
- On winding roads
- On slippery roads, such as those covered with rain, ice or snow
- On steep hills
Vehicle speed may exceed the set speed when driving down a steep hill.
- When your vehicle is towing a trailer or during emergency towing

2

When driving

تلفن شبانه روزی: ۰۲۱-۸۸۸۶۲۰۸۵

FarmaSOS.com

2-4. Using other driving systems Dynamic radar cruise control*

Dynamic radar cruise control supplements conventional cruise control with a vehicle-to-vehicle distance control. In vehicle-to-vehicle distance control mode, the vehicle automatically accelerates or decelerates in order to maintain a set following distance from vehicles ahead.

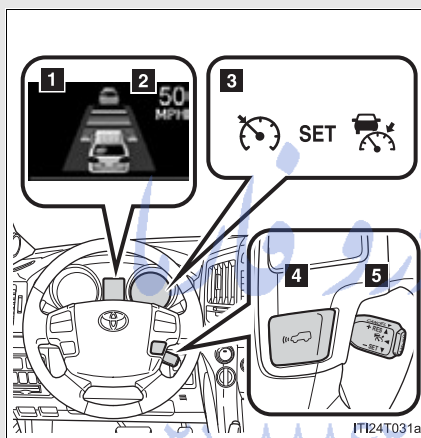

- 1 Display
- 2 Set speed
- 3 Indicators
- 4 Vehicle-to-vehicle distance button
- 5 Cruise control switch

FarmaSOS.com

*: If equipped

■ **Setting the vehicle speed (vehicle-to-vehicle distance control mode)**

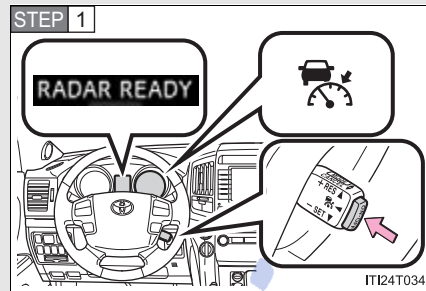

Press the “ON-OFF” button to activate the cruise control.

Dynamic radar cruise control indicator will come on.

Press the button again to deactivate the cruise control.

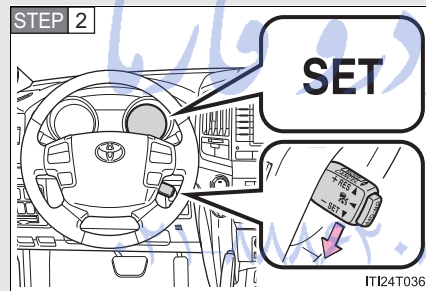

Accelerate or decelerate the vehicle to the desired speed, and push the lever down to set the speed.

“SET” indicator will come on.

The vehicle speed at the moment the lever is released becomes the set speed.

2

When driving

FarmaSOS.com

■ Adjusting the set speed

To change the set speed, operate the lever until the desired set speed is displayed.

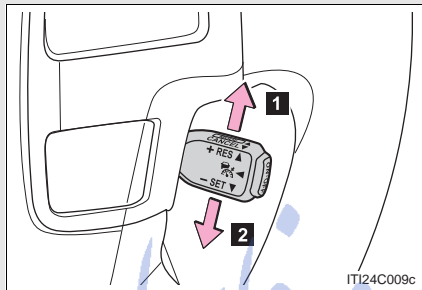

1 Increases the speed

2 Decreases the speed

Fine adjustment: Momentarily move the lever in the desired direction.

Large adjustment: Hold the lever in the desired direction.

In the vehicle-to-vehicle distance control mode, the set speed will be increased or decreased as follows:

- When the set speed is shown in “MPH”
Fine adjustment: By approximately 5 mph (8 km/h) each time the lever is operated
Large adjustment: By approximately 5 mph (8 km/h) for each 0.75 seconds the lever is held
- When the set speed is shown in “km/h”
Fine adjustment: By approximately 3.1 mph (5 km/h) each time the lever is operated
Large adjustment: By approximately 3.1 mph (5 km/h) for each 0.75 seconds the lever is held

In the constant speed control mode (→P. 221), the set speed will be increased or decreased as follows:

Fine adjustment: By approximately 1 mph (1.6 km/h) each time the lever is operated

Large adjustment: The set speed can be increased or decreased continually until the lever is released

■ **Changing the vehicle-to-vehicle distance**

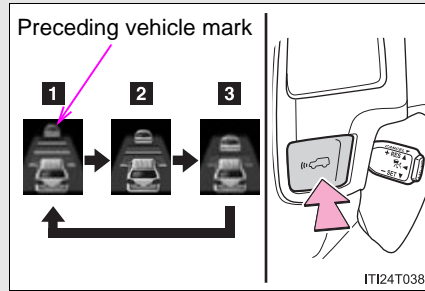

Pressing the button changes the vehicle-to-vehicle distance as follows:

- 1 Long
- 2 Medium
- 3 Short

The vehicle-to-vehicle distance is set automatically to long mode when the "ENGINE START STOP" switch is turned to IGNITION ON mode.

If a vehicle is running ahead of you, the preceding vehicle mark will also be displayed.

■ **Vehicle-to-vehicle distance settings**

Select a distance from the table below. Note that the distances shown correspond to a vehicle speed of 50 mph (80 km/h). Vehicle-to-vehicle distance increases/decreases in accordance with vehicle speed.

Distance options	Vehicle-to-vehicle distance
Long	Approximately 220 ft. (65 m)
Medium	Approximately 130 ft. (40 m)
Short	Approximately 100 ft. (30 m)

2-4. Using other driving systems

■ Canceling and resuming the speed control

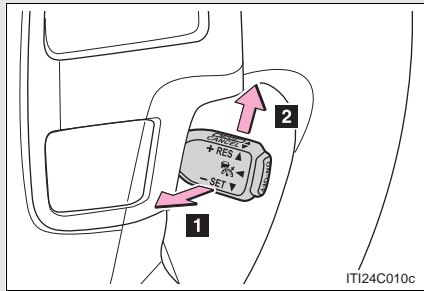

- 1** Pulling the lever toward you cancels the cruise control.

The speed setting is also canceled when the brakes are applied.

- 2** Pushing the lever up resumes the cruise control and returns vehicle speed to the set speed.

Resuming is available when the vehicle speed is more than approximately 25 mph (40 km/h).

تلفن شبانه روزی: ۰۲۱-۸۸۸۶۲۰۸۵

FarmaSOS.com

Driving in vehicle-to-vehicle distance control mode

This mode employs a radar sensor to detect the presence of vehicles up to approximately 400 ft. (120 m) ahead, determines the current vehicle-to-vehicle following distance, and operates to maintain a suitable following distance from the vehicle ahead.

Note that vehicle-to-vehicle distance will close in when traveling on long downhill slopes.

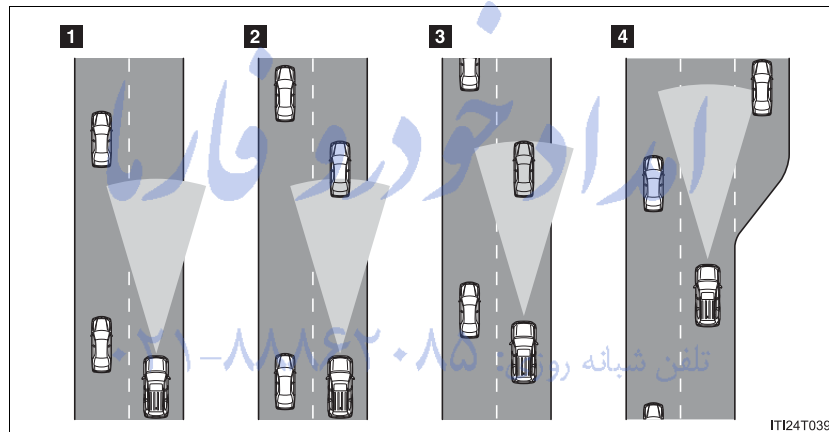

1 Example of constant speed cruising

When there are no vehicles ahead

The vehicle travels at the speed set by the driver. The desired vehicle-to-vehicle distance can also be set by operating the vehicle-to-vehicle distance control.

2 Example of deceleration cruising

When the vehicle ahead is driving slower than the set speed

When a vehicle is detected running ahead of you, the system automatically decelerates your vehicle. When a greater reduction in vehicle speed is necessary, the system applies the brakes. A warning tone warns you when the system cannot decelerate sufficiently to prevent your vehicle from closing in on the vehicle ahead.

2-4. Using other driving systems

3 Example of follow-up cruising

When following a vehicle driving slower than the set speed

The system continues follow-up cruising while adjusting for changes in the speed of the vehicle ahead in order to maintain the vehicle-to-vehicle distance set by the driver.

4 Example of acceleration

When there are no longer any vehicles ahead driving slower than the set speed

The system accelerates until the set speed is reached. The system then returns to constant speed cruising.

Approach warning

When your vehicle is too close to a vehicle ahead, and sufficient automatic deceleration via the cruise control is not possible, the display will flash and the buzzer will sound to alert the driver. An example of this would be if another driver cuts in front of you while you are following a vehicle. Apply the brakes to ensure appropriate vehicle-to-vehicle distance.

■ Warnings may not occur when

In the following instances, there is a possibility that the warnings will not occur:

- When the speed of the vehicle ahead matches or exceeds your vehicle speed
- When the vehicle ahead is traveling at an extremely slow speed
- Immediately after the cruise control speed was set
- At the instant the accelerator is applied

Selecting conventional constant speed control mode

Constant speed control mode differs from vehicle-to-vehicle distance control mode. When constant speed control mode is selected, your vehicle will maintain a set speed regardless of whether or not there are other vehicles in the lane ahead.

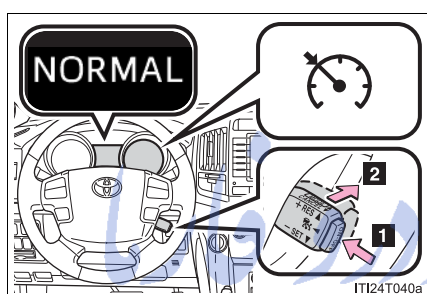

- 1** Press the “ON-OFF” button to activate the cruise control.
Press the button again to deactivate the cruise control.
- 2** Switch to constant speed control mode. (Push the lever forward and hold for approximately one second.)

Cruise control indicator will come on.

When in constant speed control mode, to return to vehicle-to-vehicle distance control mode, push the lever forward again and hold for approximately 1 second.

After the desired speed has been set, it is not possible to return to vehicle-to-vehicle distance control mode.

If the “ENGINE START STOP” switch is turned off and then turned to IGNITION ON mode again, the vehicle will automatically return to vehicle-to-vehicle distance control mode.

Adjusting the speed setting: →P. 216

Canceling and resuming the speed setting: →P. 218

■ **Dynamic radar cruise control can be set when**

- The shift lever is in "D" or range "4" or higher of "S" has been selected.
- Vehicle speed is above approximately 30 mph (50 km/h).

■ **Accelerating after setting the vehicle speed**

The vehicle can accelerate normally. After acceleration, the set speed resumes.

However, during vehicle-to-vehicle distance control mode, the vehicle speed may decrease below the set speed in order to maintain the distance to the vehicle ahead.

■ **Automatic cancelation of vehicle-to-vehicle distance control**

Vehicle-to-vehicle distance control driving is automatically canceled in the following situations:

- Actual vehicle speed falls below approximately 25 mph (40 km/h).
- VSC is activated.
- The sensor cannot operate correctly because it is covered in some way.
- The windshield wipers are operating at high speed (when the wiper switch is set to the "AUTO" mode or high speed wiper operation position).
- When second start mode is set.
- The switching operation continues for 5 seconds or more after the center differential lock switch has been operated.

If vehicle-to-vehicle distance control driving is automatically canceled for any other reason, there may be a malfunction in the system. Contact your Toyota dealer.

■ Automatic cancelation of constant speed control

The cruise control will stop maintaining the vehicle speed in the following situations:

- Actual vehicle speed is more than approximately 10 mph (16 km/h) below the set vehicle speed.
At this time, the memorized set speed is not retained.
- Actual vehicle speed falls below approximately 25 mph (40 km/h).
- VSC is activated.
- The switching operation continues for 5 seconds or more after the center differential lock switch has been operated.

■ Radar sensor and grille cover

Always keep the sensor and grille cover clean to ensure that the vehicle-to-vehicle distance control operates properly. (Some obstructions, such as snow, ice and plastic objects, cannot be detected by the obstruction sensor.) Dynamic radar cruise control is canceled if an obstruction is detected.

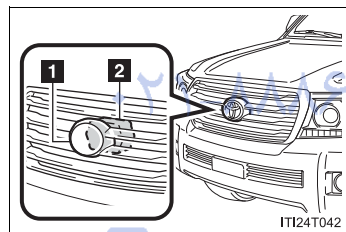

- 1 Grille cover
- 2 Radar sensor

■ Warning messages and buzzers for dynamic radar cruise control

Warning messages and buzzers are used to indicate a system malfunction or to inform the driver of the need for caution while driving. (→P. 619)

2-4. Using other driving systems

■ Certification

FCC ID: HYQDNMWR005

This device complies with part 15 of the FCC Rules. Operation is subject to the following two conditions: (1) This device may not cause harmful interference, and (2) this device must accept any interference received, including interference that may cause undesired operation.

FCC WARNING

Changes or modifications not expressly approved by the party responsible for compliance could void the user's authority to operate the equipment.

Radiofrequency radiation exposure Information:

This equipment complies with FCC radiation exposure limits set forth for an uncontrolled environment.

This equipment should be installed and operated with minimum distance of 20 cm between the radiator (antenna) and your body.

This transmitter must not be co-located or operating in conjunction with any other antenna or transmitter.

تلفن شبانه روزی: ۰۲۱-۸۸۶۲۰۸۵

FarmaSOS.com

⚠ CAUTION**■ Before using dynamic radar cruise control**

Do not overly rely on vehicle-to-vehicle distance control. Be aware of the set speed. If automatic deceleration/acceleration is not appropriate, adjust the vehicle speed, as well as the distance between your vehicle and vehicles ahead by applying the brakes, etc.

■ Cautions regarding the driving assist systems

Observe the following precautions. Failure to do so may cause an accident resulting in death or serious injury.

● Assisting the driver to measure following distance

The dynamic radar cruise control is only intended to help the driver in determining the following distance between the driver's own vehicle and a designated vehicle traveling ahead. It is not a mechanism that allows careless or inattentive driving, and it is not a system that can assist the driver in low-visibility conditions. It is still necessary for driver to pay close attention to the vehicle's surroundings.

● Assisting the driver to judge proper following distance

The dynamic radar cruise control determines whether the following distance between the driver's own vehicle and a designated vehicle traveling ahead is appropriate or not. It is not capable of making any other type of judgement. Therefore, it is absolutely necessary for the driver to remain vigilant and to determine whether or not there is a possibility of danger in any given situation.

● Assisting the driver to operate the vehicle

The dynamic radar cruise control has no capability to prevent or avoid a collision with a vehicle traveling ahead. Therefore, if there is ever any danger, the driver must take immediate and direct control of the vehicle and act appropriately in order to ensure the safety of all involved.

■ To avoid inadvertent cruise control activation

Switch the cruise control off using the "ON-OFF" button when not in use.

 CAUTION

■ **Situations unsuitable for dynamic radar cruise control**

Do not use dynamic radar cruise control in any of the following situations. Doing so may result in inappropriate speed control and could cause an accident resulting in death or serious injury.

- In heavy traffic
- On roads with sharp bends
- On winding roads
- On slippery roads, such as those covered with rain, ice or snow
- On steep downhill, or where there are sudden changes between sharp up and down gradients
Vehicle speed may exceed the set speed when driving down a steep hill.
- At entrances to expressways
- When weather conditions are bad enough that they may prevent the sensors from functioning correctly (fog, snow, sandstorm, heavy rain etc.)
- When an approach warning buzzer is heard often
- When your vehicle is towing a trailer or during emergency towing

FarmaSOS.com

⚠ CAUTION**■ When the radar sensor may not be correctly detecting the vehicle ahead**

Apply the brakes as necessary when any of the following types of vehicles are in front of you.

As the sensor may not be able to correctly detect these types of vehicles, the approach warning (→P. 220) will not be activated, and a fatal or serious accident may result:

- Vehicles that cut in suddenly
- Vehicles traveling at low speeds
- Vehicles that are not moving
- Vehicles with small rear ends (trailers with no load on board etc.)
- Motorcycles traveling in the same lane

■ Conditions under which the vehicle-to-vehicle distance control may not function correctly

Apply the brakes as necessary in the following conditions as the radar sensor may not be able to correctly detect vehicles ahead, and a fatal or serious accident may result:

- When water or snow thrown up by the surrounding vehicles hinders the functioning of the sensor
- When your vehicle is pointing upwards (caused by a heavy load in the luggage compartment, etc.)
- When the road curves or when the lanes are narrow
- When steering wheel operation or your position in the lane is unstable
- When the vehicle ahead of you decelerates suddenly

 CAUTION

■ **Handling the radar sensor**

Observe the following to ensure the cruise control system can function effectively.

Otherwise, the system may not function correctly and could result in an accident.

- Keep the sensor and grille cover clean at all times.
Clean the sensor and grille cover with a soft cloth so you do not mark or damage them.
- Do not subject the sensor or surrounding area to a strong impact.
If the sensor moves even slightly off position, the system may malfunction.
If the sensor or surrounding area is subject to a strong impact, always have the area inspected and adjusted by your Toyota dealer.
- Do not disassemble the sensor.
- Do not attach accessories or stickers to the sensor, grille cover or surrounding area.
- Do not modify or paint the sensor and grille cover.
- Do not replace them with non-genuine parts: تلفن شبانه روزی: ۰۲۱-۸۴۸۸۰۰۰۰

FarmaSOS.com

2-4. Using other driving systems Intuitive parking assist

The distance from your vehicle to nearby obstacles when parallel parking or maneuvering into a garage is measured by the sensors and communicated via the multi-information display, touch screen and a buzzer. Always check the surrounding area when using this system.

■ Sensor types

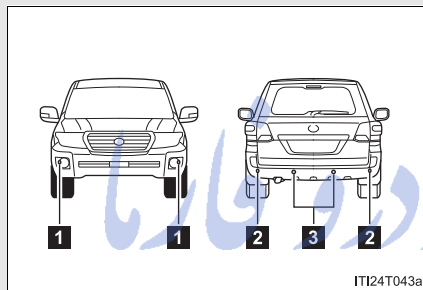

- 1 Front corner sensors
- 2 Rear corner sensors
- 3 Rear center sensors

■ Intuitive parking assist switch

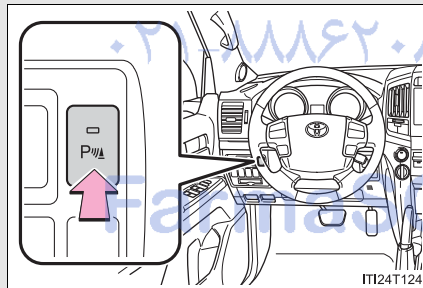

On/off

To turn the system on, press the switch. The indicator light comes on and the buzzer sounds to inform the driver that the system is operational.

To turn the system off, press the switch again.

2-4. Using other driving systems

■ Multi-information display

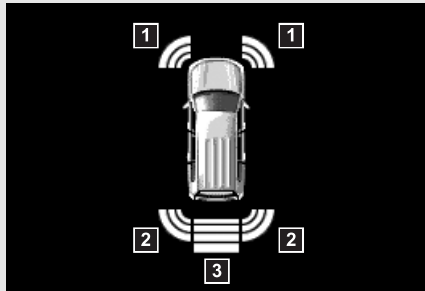

- 1 Front corner sensor detection
- 2 Rear corner sensor detection
- 3 Rear center sensor detection

■ Touch screen (vehicles with a navigation system)

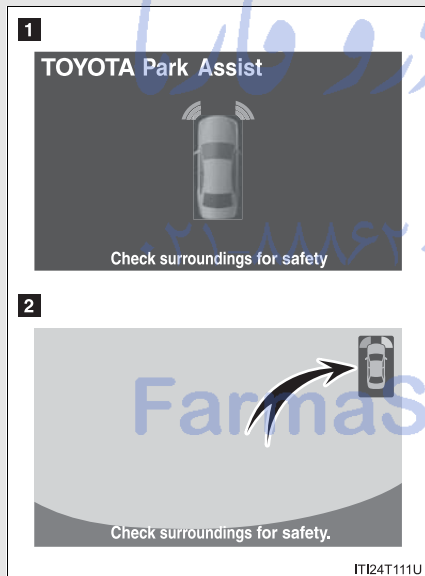

- 1 When the rear view monitor, Toyota parking assist monitor or Multi-terrain Monitor is not displayed







The graphic is automatically displayed when an obstacle is detected. The screen can be set so that the graphic is not displayed. (→P. 235)

- 2 When the rear view monitor, Toyota parking assist monitor or Multi-terrain Monitor is displayed (insert display)

A simplified image is displayed on the touch screen when an obstacle is detected.

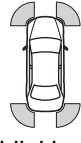

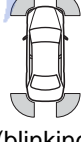

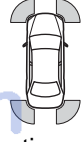



Sensor detection display, obstacle distance

■ **Corner sensors**

Approximate distance to obstacle	Multi-information display	Touch screen	
			Insert display
Front: 1.6 ft. (50 cm) to 1.2 ft. (37.5 cm) Rear: 2.0 ft. (60 cm) to 1.5 ft. (45 cm)	 (continuous)	 (continuous)	 (blinking)
Front: 1.2 ft. (37.5 cm) to 0.8 ft. (25 cm) Rear: 1.5 ft. (45 cm) to 1.0 ft. (30 cm)	 (continuous)	 (continuous)	 (blinking rapidly)
Front: Less than 0.8 ft. (25 cm) Rear: Less than 1.0 ft. (30 cm)	 (blinking)	 (continuous)	 (continuous)

2-4. Using other driving systems

■ Rear center sensors

Approximate distance to obstacle	Multi-information display	Touch screen (insert display)
4.9 ft. (150 cm) to 2.6 ft. (80 cm)	 (continuous)	 (blinking slowly)
2.6 ft. (80 cm) to 2.1 ft. (65 cm)	 (continuous)	 (blinking)
2.1 ft. (65 cm) to 1.6 ft. (50 cm)	 (continuous)	 (blinking rapidly)
Less than 1.6 ft. (50 cm)	 (blinking)	 (continuous)

■ **Buzzer operation and distance to an obstacle**

A beep sounds when the corner sensors and rear center sensors are operating.

- The buzzer beeps faster as the vehicle approaches an obstacle. When the vehicle comes within the following distance of the obstacle, the buzzer sounds continuously:
 - Front corner sensors: Approximately 0.8 ft. (25 cm)
 - Rear corner sensors: Approximately 1.0 ft. (30 cm)
 - Rear center sensors: Approximately 1.6 ft. (50 cm)
- When 2 or more obstacles are detected simultaneously, the beep system responds to the nearest obstacle. If one or both come within the above distances, the beep will repeat a long tone, followed by fast beeps.
- You can change the volume of the warning beeps. (→P. 235)

تلفن شبانه روزی: ۰۲۱-۸۸۸۶۲۰۸۵

FarmaSOS.com

2-4. Using other driving systems

Detection range of the sensors

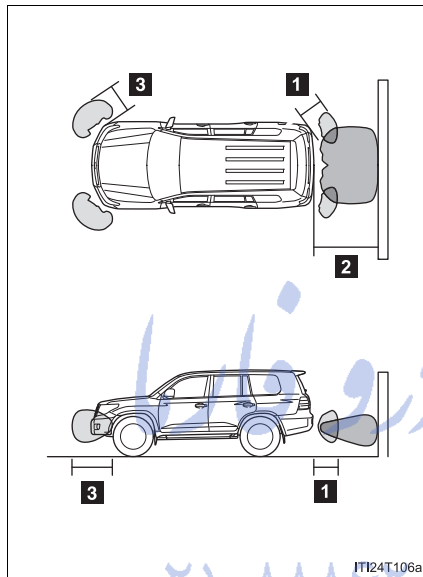

- 1** Approximately 2.0 ft. (60 cm)
- 2** Approximately 4.9 ft. (150 cm)
- 3** Approximately 1.6 ft. (50 cm)

The diagram shows the detection range of the sensors. Note that the sensors cannot detect obstacles that are extremely close to the vehicle.

The range of the sensors may change depending on the shape of the object etc.

Setting up intuitive parking assist (vehicles with a navigation system)

You can change the warning beep volume and touch screen operating conditions.

STEP 1 Press the "SETUP" button.

STEP 2 Touch "Vehicle" on the "Setup" screen.

STEP 3 Touch "Toyota Park Assist" on the "Vehicle Settings" screen.

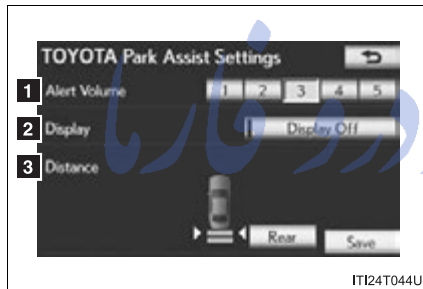

1 Alert volume setting

2 Display on/off

3 Alert distance setting

Make sure to save after changing settings.

2

When driving

■ **Alert volume setting**

The alert volume can be adjusted.

STEP 1 Touch "1" to "5" on the "TOYOTA Park Assist settings".

STEP 2 Touch "Save".

FarmaSOS.com

2-4. Using other driving systems

■ Display on/off setting

On or off can be selected for intuitive parking assist display.

STEP 1 Touch "Display Off".

When the "Display Off" indicator is turned on, the display of intuitive parking assist will be off. Touch "Display Off" again to turn the display of intuitive parking assist on.

STEP 2 Touch "Save".

■ Alert distance setting

Front or rear center sensors display and tone indication can be set.

STEP 1 Touch "Rear".

Long distance or short distance can be selected.

STEP 2 Touch "Save".

■ The intuitive parking assist can be operated when

● Front corner sensors:

- The "ENGINE START STOP" switch is in IGNITION ON mode.
- The shift lever is in a position other than "P".
- The vehicle speed is less than approximately 6 mph (10 km/h).

● Rear corner and rear center sensors:

- The "ENGINE START STOP" switch is in IGNITION ON mode.
- The shift lever is in "R".

■ Intuitive parking assist display

When an obstacle is detected while the rear view monitor system, Toyota parking assist monitor or Multi-terrain Monitor is in use, the warning indicator will appear in the top right of the screen even if the display setting has been set to off.

■ Sensor detection information

- The sensor's detection areas are limited to the areas around the vehicle's front corner and rear bumpers.
- Certain vehicle conditions and the surrounding environment may affect the ability of the sensor to correctly detect obstacles. Particular instances where this may occur are listed below.
 - There is dirt, snow or ice on the sensor. (Wiping the sensors will resolve this problem.)
 - The sensor is frozen. (Thawing the area will resolve this problem.)
In especially cold weather, if a sensor is frozen the screen may show an abnormal display, or obstacles may not be detected.
 - The sensor is covered in any way.
 - The vehicle is leaning considerably to one side.
 - On an extremely bumpy road, on an incline, on gravel, or on grass
 - The vicinity of the vehicle is noisy due to vehicle horns, motorcycle engines, air brakes of large vehicles, or other loud noises producing ultrasonic waves.
 - There is another vehicle equipped with parking assist sensors in the vicinity.
 - The sensor is coated with a sheet of spray or heavy rain.
 - The vehicle is equipped with a fender pole or wireless antenna.
 - Towing eyelets are installed.
 - The bumper or sensor receives a strong impact.
 - The vehicle is approaching a tall or curved curb.
 - In harsh sunlight or intense cold weather
 - The area directly under the bumpers is not detected.
 - If obstacles draw too close to the sensor.
 - A non-genuine Toyota suspension (lowered suspension etc.) is installed.
 - People may not be detected if they are wearing certain types of clothing.

In addition to the examples above, there are instances in which, because of their shape, signs and other objects may be judged by the sensor to be closer than they are.

2-4. Using other driving systems

- The shape of the obstacle may prevent the sensor from detecting it. Pay particular attention to the following obstacles:
 - Wires, fences, ropes, etc.
 - Cotton, snow and other materials that absorb sound waves
 - Sharply-angled objects
 - Low obstacles
 - Tall obstacles with upper sections projecting outwards in the direction of your vehicle
- The following situations may occur during use.
 - Depending on the shape of the obstacle and other factors, the detection distance may shorten, or detection may be impossible.
 - Obstacles may not be detected if they are too close to the sensor
 - There will be a short delay between obstacle detection and display. Even at slow speeds, there is a possibility that the obstacle will come within the sensor's detection areas before the display is shown and the warning beep sounds.
 - Thin posts or objects lower than the sensor may not be detected for collision when approached, even if they have been detected once.
 - It might be difficult to hear beeps due to the volume of audio system or air flow noise of air conditioning system.

■ **If a message is displayed on the multi-information display**

→P. 619

FarmaSOS.com

⚠ CAUTION**■ When using the intuitive parking assist**

Observe the following precautions.

Failing to do so may result in the vehicle being unable to be driven safely and possibly cause an accident.

- Do not use the sensor at speeds in excess of 6 mph (10 km/h).
- The sensors' detection areas and reaction times are limited. When moving forward or reversing, check the areas surrounding the vehicle (especially the sides of the vehicle) for safety, and drive slowly, using the brake to control the vehicle's speed.
- Do not install accessories within the sensors' detection areas.

⚠ NOTICE**■ When using intuitive parking assist**

In the following situations, the system may not function correctly due to a sensor malfunction etc. Have the vehicle checked by your Toyota dealer.

- A beep does not sound when you turn the main switch on.
- The intuitive parking assist operation display flashes, and a beep sounds when no obstacles are detected.
- If the area around a sensor collides with something, or is subjected to strong impact.
- If the bumper collides with something.
- If the display shows continuously without a beep.
- If a display error occurs, first check the sensor.
If the error occurs even if there is no ice, snow or mud on the sensor, it is likely that the sensor is malfunctioning.

■ Notes when washing the vehicle

Do not apply intensive bursts of water or steam to the sensor area.

Doing so may result in the sensor malfunctioning.

2-4. Using other driving systems Four-wheel drive system

Use the four-wheel drive control switch and center differential lock/unlock switch to select the following transfer and center differential modes.

■ Four-wheel drive control switch

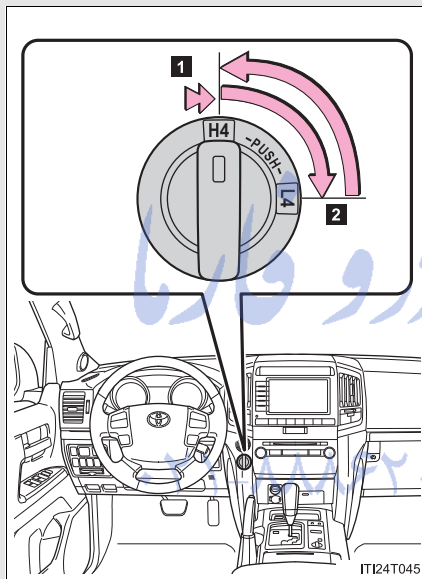

1 "H4" (high speed position)

Normal driving on all types of roads.

2 "L4" (low speed position)

Driving requiring maximum power and traction such as climbing or descending steep hills, off-road driving, and hard pulling in sand or mud, etc.

■ Center differential lock/unlock switch

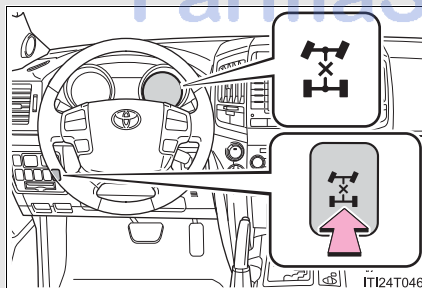

Lock the center differential when your vehicle's wheels get stuck in a ditch or when driving on a slippery or bumpy surface.

Unlock the center differential after the wheels have been freed, or after moving to a flat, non-slippery surface.

Shifting between “H4” and “L4”

■ Shifting from “H4” to “L4”

STEP 1 Stop the vehicle completely.

STEP 2 Shift the shift lever to “N”.

STEP 3 Push and turn the four-wheel drive control switch fully clockwise.

Maintain this condition until the low speed four-wheel drive indicator light turns on.

■ Shifting from “L4” to “H4”

STEP 1 Stop the vehicle completely.

STEP 2 Shift the shift lever to “N”.

STEP 3 Turn the four-wheel drive control switch fully counterclockwise.

Maintain this condition until the low speed four-wheel drive indicator light turns off.

2

When driving

تلفن شبانه روزی: ۰۲۱-۸۸۶۲۰۸۵

FarmaSOS.com

■ **The four-wheel drive control switch can be operated when**

- The “ENGINE START STOP” switch is in IGNITION ON mode.
- The shift lever is in the “N” position.
- The vehicle is stopped completely.

■ **The low speed four-wheel drive indicator light**

The indicator light blinks while shifting between “H4” and “L4”.

■ **Advice for driving on slippery roads**

- If you shift the four-wheel drive control switch to “L4” and the shift lever to the “2” range of “S” while driving in steep off-road areas, the output of the brake can be controlled effectively by the Active TRAC, which assists the driver to control the driving power of 4 wheels.
- Use the “1” range of “S” of the shift lever for maximum power and traction when your wheels get stuck or when driving down a steep incline.

■ **The center differential lock indicator light**

The indicator light blinks while locking/unlocking the center differential.

■ **The center differential lock/unlock switch can be operated when**

- The “ENGINE START STOP” switch is in IGNITION ON mode.
- The vehicle speed is less than 60 mph (100 km/h).

■ **Locking/unlocking the center differential**

- When the four-wheel drive control switch is in L4 with the center differential locked, VSC is automatically turned off. (The center differential lock and VSC OFF indicator lights come on.)
- If the operation is not completed, the center differential lock indicator blinks. If the indicator light does not turn off when unlocking the center differential, drive straight ahead while accelerating or decelerating, or drive in reverse.
- If the center differential lock/unlock is not completed within 5 seconds while the cruise control system is on, cancel the cruise control system.

■ **If the low speed four-wheel drive indicator light or the center differential lock indicator light blinks**

- If the low speed four-wheel drive indicator light continues to blink when using the four-wheel drive control switch, stop the vehicle completely, move the shift lever to “N” and operate the switch again.
- If the shift lever is moved before the low speed four-wheel drive indicator turns on/off, the transfer mode may not be shifted completely. The transfer mode disengages both the front and rear driveshafts from the powertrain and allows the vehicle to move regardless of the shift position. (At this time, the indicator blinks and the buzzer sounds.)

Therefore, the vehicle is free to roll even if the automatic transmission is in “P”. You or someone else could be seriously injured. You must complete the shifting of the transfer mode.

To complete the shifting, stop the vehicle completely, return the shift lever to “N”, and confirm that the shift was completed (the indicator turns on/off).

- If the engine coolant temperature is too low, the four-wheel drive control system may not be able to shift. When the engine is warmer press the switch again.

If the low speed four-wheel drive indicator light or the center differential lock indicator light continues to blink even after attempting the above, there may be a malfunction in the engine, the brake system or the four-wheel drive system. In this case, you may not be able to shift between “H4” and “L4”, and the center differential lock may not be operable. Have the vehicle inspected by your Toyota dealer immediately.

 CAUTION

■ **While driving**

Never move the four-wheel drive control switch if the wheels have lost traction. Doing so may cause an accident resulting in death or serious injury.

■ **When the vehicle is parked**

If the shift lever is moved before the low speed four-wheel drive indicator turns on/off, the transfer mode may not be shifted completely. The transfer mode disengages both the front and rear driveshafts from the powertrain and allows the vehicle to move regardless of the shift position. (At this time, the indicator blinks and the buzzer sounds.)

Therefore, the vehicle is free to roll even if the automatic transmission is in "P". You or someone else could be seriously injured. You must complete the shifting of the transfer mode. (→P. 240)

 NOTICE

■ **To prevent damage to the center differential**

- For normal driving on dry and hard surface roads, unlock the center differential.
- Unlock the center differential after the wheels are out of the ditch or off the slippery or bumpy surface.
- Do not push the center differential lock/unlock switch when the vehicle is turning or when its wheels are spinning freely off the ground.

2-4. Using other driving systems

Crawl Control (with Turn Assist function)

Allows travel on extremely rough off-road surfaces at a fixed low speed without pressing the accelerator or brake pedal. Minimizes loss of traction or vehicle slip when driving on slippery road surfaces, allowing for stable driving.

■ Crawl Control switch

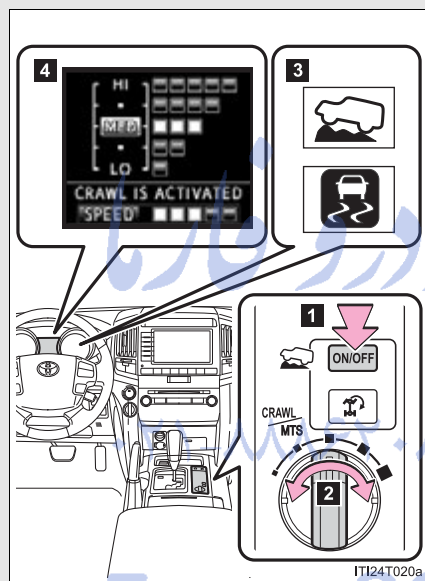

- 1 ON/OFF switch
- 2 Speed selection switch
- 3 Indicators

The Crawl Control indicator is lit and the slip indicator flashes when operating.

- 4 Multi-information display

The operating status and speed select status of the Crawl Control are shown on the multi-information display.

2

When driving

2-4. Using other driving systems

■ Speed modes

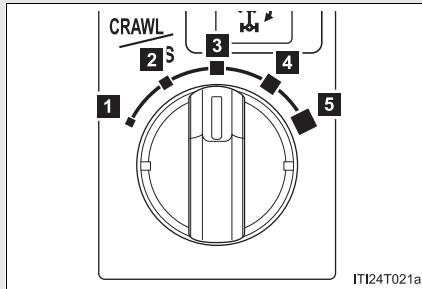

The following table shows some typical terrains and the recommended speed modes.

Mode		Road condition
1	Lo	Rock, mogul (downhill) and gravel (downhill)
2	Lo-Med	Mogul (uphill)
3	Med	
4	Med-Hi	Snow, mud, gravel (uphill), sand, dirt, mogul (uphill) and grass
5	Hi	

■ Turn Assist function

This function assists cornering performance in accordance with steering operation when driving through a tight corner. It maintains vehicle speed while driving and reduces the number of turns needed to navigate a corner that requires turning the wheel in the opposite direction.

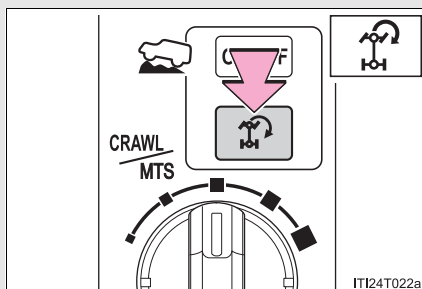

Press the Turn Assist switch while Crawl Control is operating.

Turn Assist indicator will come on.

To turn the system off, press the switch again.

When the system is turned off

▶ Crawl Control

Press the ON/OFF switch while Crawl Control is operating. If the switch is turned off, the slip indicator and the Turn Assist indicator will go off (if the Turn Assist function is in use), the Crawl Control indicator will flash until the system has turned off completely, and a message stating that Crawl Control has been turned off will be displayed on the multi-information display for several seconds.

When turning off Crawl Control while driving, stop the vehicle before the Crawl Control indicator turns off, or drive extremely carefully.

▶ Turn Assist function

Press the Turn Assist switch while the Turn Assist function is operating. When the switch is pressed, the Turn Assist indicator will go off, and a message stating that the Turn Assist function has been turned off will be displayed on the multi-information display for several seconds.

2

When driving

FarmaSOS.com

■ **The Crawl Control and Turn Assist function can be operated when**

▶ Crawl Control

- The engine is running.
- The shift lever is in any gear other than “P” or “N”.
- The four-wheel drive control switch is in “L4”.
- The driver’s door is closed.

▶ Turn Assist function

- Crawl Control is operating.
- The center differential is not locked.
- The accelerator and brake are not being operated.
- The shift lever is in any gear other than “P”, “R” or “N”.
- The steering wheel is turned very far.

■ **Automatic system cancelation**

▶ Crawl Control

In the following situations, the buzzer will sound intermittently and Crawl Control will be canceled automatically. In this event, the Crawl Control indicator will flash and then go off, the Turn Assist indicator will go off (if the Turn Assist function is in use), and a message stating that Crawl Control has been turned off will be displayed on the multi-information display for several seconds.

- When the shift lever is moved to “P” or “N”.
- When the four-wheel drive control switch is in “H4”.
- When the driver’s door is opened.

▶ Turn Assist function

When the center differential is locked, the buzzer will sound intermittently and the Turn Assist function will be canceled automatically. In this event, the Turn Assist indicator will go off, and a message stating that the Turn Assist function has been turned off will be displayed on the multi-information display for several seconds.

■ Function limitations

▶ Crawl Control

- In the following situations, brake control can be used to drive downhill at a constant speed. However, engine control is not available when driving uphill at a constant speed.
 - When switched to second start mode.
- In the following situation, engine control and brake control will stop temporarily. In this event, the Crawl Control indicator will flash.
 - When the vehicle speed exceeds approximately 15 mph (25 km/h).

▶ Turn Assist function

In the following situations, the Turn Assist function will stop temporarily. In this event, the Turn Assist indicator will flash.

- When the vehicle speed exceeds approximately 6 mph (10km/h).
- When the shift lever is moved to "R".

■ When the Crawl Control system is operated continuously

- If Crawl Control is used continuously for a long time, the buzzer will sound, a malfunction notification will be displayed on the multi-information display, the Crawl Control indicator will go off, and Crawl Control will be temporarily inoperable as a result of the brake system overheating. In this event, stop the vehicle immediately in a safe place, and allow the brake system to cool down sufficiently until the "TRAC OFF" on the multi-information display goes off. (In the meantime, normal driving is possible.)
- If Crawl Control is used continuously for a long time, the buzzer will sound, the system will be temporarily canceled, and a malfunction notification will be displayed on the multi-information display as a result of the automatic transmission system overheating. Stop the vehicle in a safe place until the display goes off.

2-4. Using other driving systems

■ Sounds and vibrations caused by the Crawl Control system

- A sound may be heard from the engine compartment when the engine is started or just after the vehicle begins to move. This sound does not indicate that a malfunction has occurred in Crawl Control system.
- Either of the following conditions may occur when the Crawl Control system is operating. None of these are indicators that a malfunction has occurred.
 - Vibrations may be felt through the vehicle body and steering.
 - A motor sound may be heard after the vehicle comes to a stop.

■ When there is a malfunction in the system

Warning lights and/or warning messages will turn on. (→P. 608, 619)

CAUTION

■ When using Crawl Control and Turn Assist function

Do not rely solely on the Crawl Control and Turn Assist function. This function does not extend the vehicle's performance limitations. Always thoroughly check the road conditions, and drive safely.

■ These conditions may cause the system not to operate properly

When driving on the following surfaces, the system may not be able to maintain a fixed low speed, which may result in an accident:

- Extremely steep inclines.
- Extremely uneven surfaces.
- Snow-covered roads, or other slippery surfaces.

NOTICE

■ When using Turn Assist function

The Turn Assist function is a function to assist turning performance when driving off road. The function may be less effective on paved road surfaces.

2-4. Using other driving systems Multi-terrain Select

Multi-terrain Select is a system that assists drivability in off-road situations.

Select a mode that most closely matches the type of terrain on which you are driving from among 5 modes.

Brake control can be optimized in accordance with the selected mode.

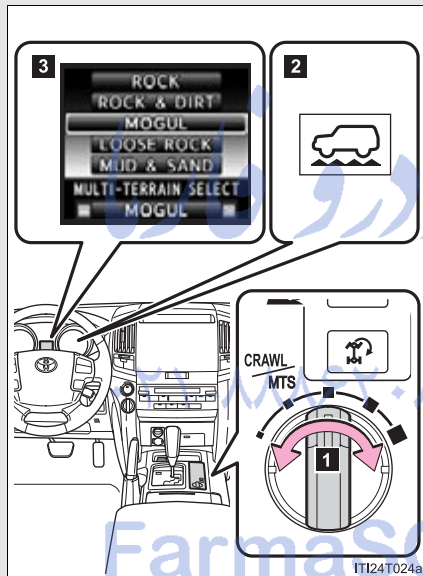

- 1** Multi-terrain Select mode select switch
- 2** Multi-terrain Select indicator
- 3** Multi-information display
Displays status information including operating status and road type selection.

2

When driving

2-4. Using other driving systems

■ Selectable modes

A mode which matches the road conditions can be selected from among the following 5 modes.

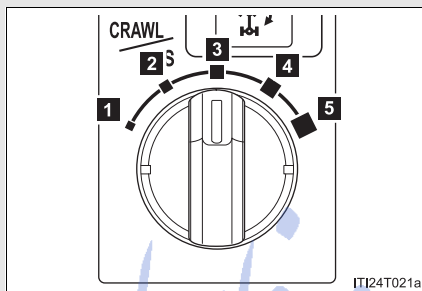

- 1** MUD & SAND
- 2** LOOSE ROCK
- 3** MOGUL
- 4** ROCK & DIRT
- 5** ROCK

	Mode	Road Conditions
1	MUD & SAND	Suitable for muddy roads, sandy roads, snow-covered roads, dirt trails and other slippery or dirty conditions
2	LOOSE ROCK	Suitable for slippery conditions consisting of mixtures of earth and loose rock
3	MOGUL	Suitable for very bumpy road conditions, such as mogul roads
4	ROCK & DIRT	Suitable for very bumpy road conditions, such as mogul or rocky roads
5	ROCK	Suitable for rocky terrain

■ **Multi-terrain Select control starting conditions**

When all of the following conditions are satisfied, the Multi-terrain Select indicator will come on, the mode select screen will be displayed on the multi-information display, and Multi-terrain Select control will begin.

- The four-wheel drive control switch is in "L4".
- Both Active TRAC and VSC are not off.
- Crawl Control is off.

■ **Switching modes**

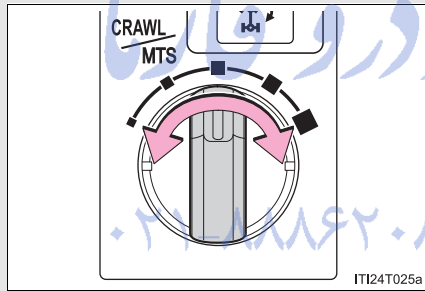

Operate the Multi-terrain Select mode select switch during Multi-terrain Select control to select a mode.

Once the mode is confirmed, the mode name will be displayed and the control will switch.

2-4. Using other driving systems

Statement on the multi-information display

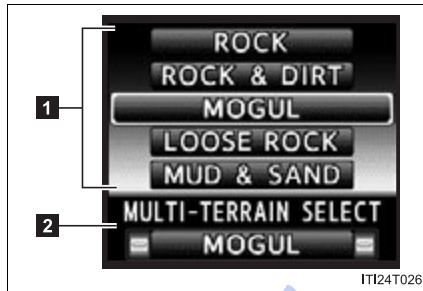

1 Mode selection

Display the Multi-terrain Select mode.

The display switches in accordance with the pressing of the DISP switch (→P. 190) or the conditions of each system.

2 Mode status

Display the name of the selected mode.

تلفن شبانه روزی: ۰۲۱-۸۸۸۶۲۰۸۵

FarmaSOS.com

■ Automatic system cancelation

In the following situations, the Multi-terrain Select indicator will go off, and Multi-terrain Select will be canceled automatically.

- When the four-wheel drive control switch is in "H4".
- When Active TRAC and VSC are off.
- When Crawl Control is on.

■ When it is difficult to generate traction

MUD & SAND mode provides the largest amount of tire slippage, followed by LOOSE ROCK, MOGUL, ROCK & DIRT and ROCK mode.

Drivability can be improved by selecting a mode which provides a smaller amount of tire slippage than the current mode when the amount of tire slippage is large, or conversely selecting a mode which provides a larger amount of tire slippage than the current mode when the amount of tire slippage is small.

■ When the vehicle is stuck

Switching the transfer and differential

For the operation of the following functions, refer to the following pages.

- Four-wheel drive system (→P. 240)
- Center differential lock (→P. 240)

■ When the brake system operates continuously

The brake system may overheat. In this case, a buzzer will sound, either the "TRAC OFF" will be displayed on the multi-information display, and Multi-terrain Select will be temporarily inoperable. In this event, stop the vehicle immediately in a safe place, and allow the brake system to cool down sufficiently. (There is no problem with continuing normal driving.)

After a short time, the message on the multi-information display will go off, and you will be able to use Multi-terrain Select.

■ When there is a malfunction in the system

The slip indicator light will come on. Have the vehicle inspected by your Toyota dealer immediately.

2-4. Using other driving systems

CAUTION

■ When using the Multi-terrain Select

Observe the following precautions to avoid an accident that could result in death or serious injuries:

- There is a chance that the selected mode may not be the most appropriate in terms of road conditions such as pitch, slipperiness, undulation, etc. (→P. 252)
- Multi-terrain Select is not intended to expand the limits of the vehicle. Check the road conditions thoroughly beforehand, and drive safely and carefully.

NOTICE

■ Precaution for use

The Multi-terrain Select is intended for use during off-road driving. Do not use the system at any other time.

امداد خودرو فارما
تلفن شبانه روزی: ۰۲۱-۸۸۸۶۲۰۸۵

FarmaSOS.com

2-4. Using other driving systems Multi-terrain Monitor*

The Multi-terrain Monitor displays the vehicle surroundings when driving at low speeds, thus assisting off-road driving and helping the driver to check the vehicle surroundings.

- By pressing the VIEW switch, the display can be shown, or the display image can be changed between the front screen, wide view front & side monitor screen, side-front simultaneous display monitor screen, side-rear simultaneous display monitor screen or rear screen. (The screens that can be selected differ depending on the shift position and the transfer mode.)
- By referring to the guidelines shown on the front monitor screen, you can decide a driving line while assessing the distance to obstacles ahead of the vehicle and confirm the projected path, and by using the wide view front & side monitors, the side-front simultaneous display monitor and the side-rear simultaneous display monitor to identify objects in the vicinity or course of the tires, you can drive while preventing the vehicle from becoming stuck unexpectedly.

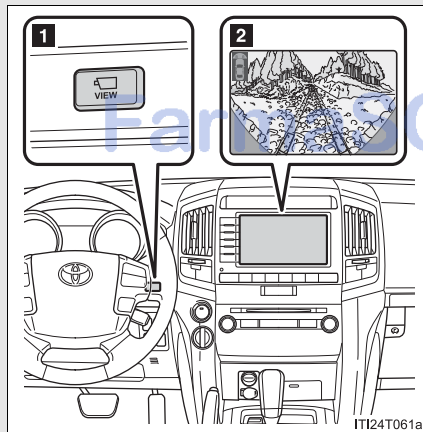

- 1 VIEW switch
- 2 Touch screen

*: If equipped

2-4. Using other driving systems

■ **Switching the image**

- When the shift lever is in “D”, “S” or “N”

Normal display mode: Press the VIEW switch to display the screen.

Automatic display mode: The screen is displayed automatically.

The screen will switch each time the VIEW switch is pressed. (The switching screen differs in accordance with the transfer range.)

Four-wheel drive control switch position	Display
H4	Wide view front & side monitor display ← ↓ Side-front simultaneous display monitor ↓ Side-rear simultaneous display monitor —
L4	Front monitor ← ↓ Side-front simultaneous display monitor ↓ Side-rear simultaneous display monitor —

- When the shift lever is in “R”

If the shift lever is shifted to “R”, the rear monitor (Toyota parking assist monitor) will be displayed, and the screen will switch every time the VIEW switch is pressed.

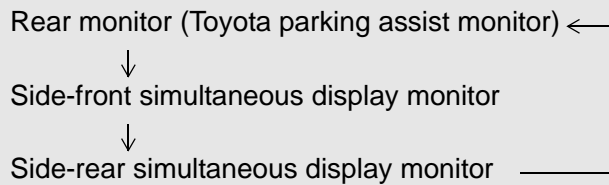

■ **Automatic display mode**

In this mode, the screen is switched automatically in response to vehicle speed and shift lever operation, in addition to screen switching by operating the VIEW switch.

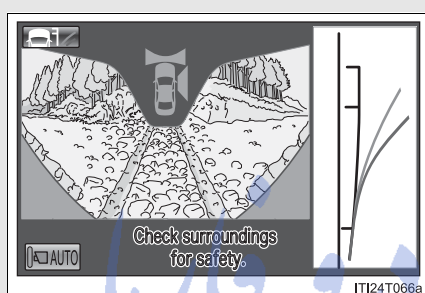

Touch "AUTO" on the front or wide view front & side monitor screen.

The "AUTO" indicator will come on.

Touch "AUTO" again to return to normal display mode.

2

When driving

تلفن شبانه روزی: ۰۲۱-۸۸۸۶۲۰۸۵

FarmaSOS.com

Range covered by each camera

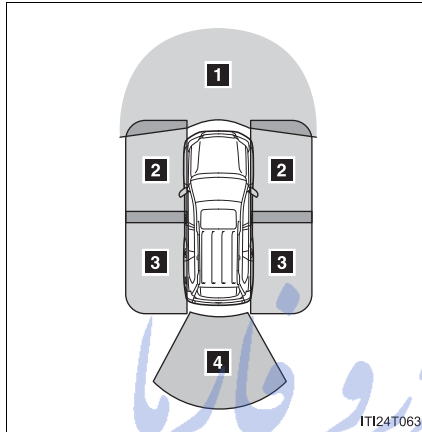

- 1** Front monitor*
- 2** Side-front simultaneous display monitor*
- 3** Side-rear simultaneous display monitor*
- 4** Rear monitor

*:Range of wide view front & side monitor display (The monitor for side displays right side only.)

The illustration shown here is an example. As such, the actual visible area may be different. See P. 272 for information about the visual range of each camera.

تلفن شبانه روزی: ۰۲۱-۸۸۸۶۲۰۸۵

FarmaSOS.com

Display

■ **Front monitor**

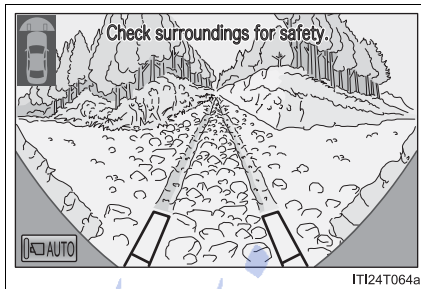

The image from the front camera is displayed. Use this monitor to help check the area in front of the vehicle for safety. Guidelines are shown to help determine the course.

■ **Wide view front & side monitor display**

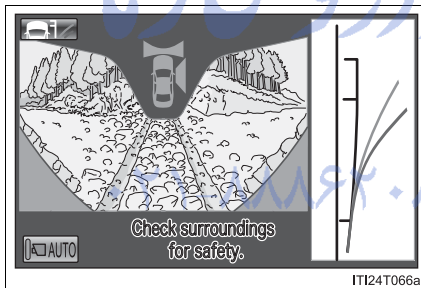

Images from the front and the sides of the vehicle are displayed.

This display is used to verify the situation at crossings with poor visibility, and to assist with safety confirmation when turning right.

Guidelines can also be displayed as a steering guide when turning right.

■ **Side-front simultaneous display monitor**



The image from both side cameras is displayed. Use this monitor to help check the area on both sides of the vehicle at the same time, and to check for objects near the tires or the sides of the vehicle. Guidelines showing an image of the vehicle width and the position of the front tires are displayed.

2-4. Using other driving systems

■ Side-rear simultaneous display monitor

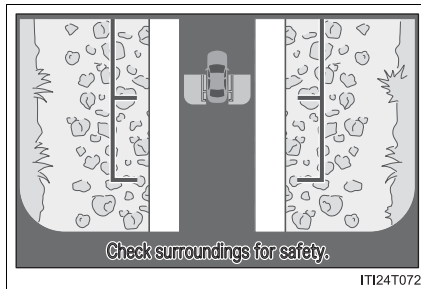

The image from both side cameras is displayed. Use this monitor to help check the area on both sides of the vehicle at the same time, and to check for objects near the tires or the sides of the vehicle. Guidelines showing an image of the vehicle width and the position of the rear tires are displayed.

■ Rear monitor (Toyota parking assist monitor)

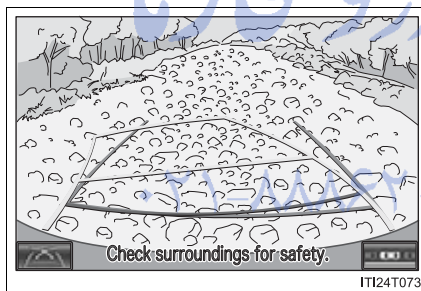

The image from the rear camera is displayed. For information regarding the Toyota parking assist monitor, refer to "Navigation System Owner's Manual".

تلفن شبانه روزی: ۸۵

FarmaSOS.com

Using the monitor

■ **Front monitor**

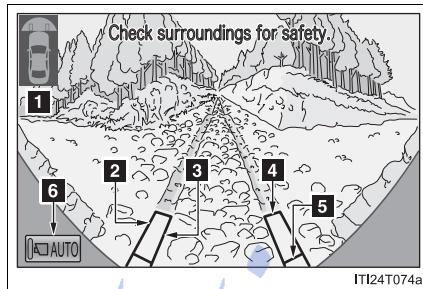

1 Vehicle icon

Displays the image being shown by the front monitor.

2 Trajectory line (outside)*

Indicates the outer path of the tire.

3 Trajectory line (inside)*

Indicates the inner path of the tire.

4 Distance guideline (yellow)

Shows the position about 3.3 ft. (1 m) away from the front edge of the vehicle.

5 Distance guideline (red)

Shows the position about 1.6 ft. (0.5 m) away from the front edge of the vehicle.

6 Automatic display mode

Switches the projected course mode

The trajectory lines move according to the steering wheel position.

*:While the Turn Assist function of Crawl Control is operating, the trajectory lines will be displayed as dotted lines. At this time, there may be a difference between the trajectory lines and the actual course of progression.

2

When driving

Wide view front & side monitor display

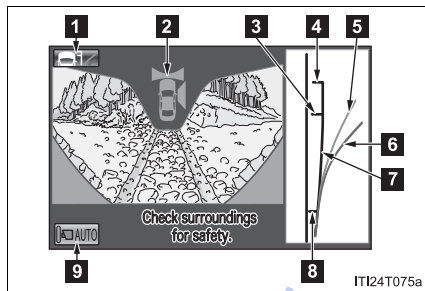

1 Projected course line switching button

The course line display mode will change as follows each time the switch is touched.

When the shift lever is in "R", display mode can not be changed.

2 Vehicle icon

Displays the image being shown by the front monitor.

3 Front wheel contact point

Shows the position of the vehicle's front tire.

4 Vehicle front edge line

Shows the position of the vehicle's leading edge.

5 Projected course line (yellow)

Displays a rough guide of the vehicle path that moves according to the steering wheel position. Displayed along with the minimum projected turning circle.

6 Minimum projected turning circle (blue)

Displays the smallest turning circle projected by the system if the steering wheel is turned to full lock. Displayed when the steering wheel is turned to the right (further than 90° from straight ahead).

7 Vehicle width line (blue)

Indicates the width of the vehicle including the outside rear view mirror.

8 Rear wheel contact point

Shows the position of the vehicle's rear tire.

9 Automatic display mode

Switches the projected course mode

2

When driving

ایراد خودرو فارما

۰۲۱-۸۸۸۶۲۰۸۵

FarmaSOS.com

2-4. Using other driving systems

■ Side-front simultaneous display monitor

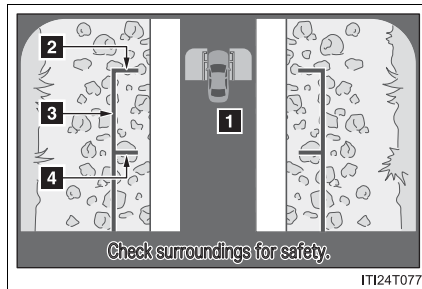

1 Vehicle icon

Displays the image being shown by the side-front simultaneous display monitor.

2 Vehicle front edge line

Shows the position of the vehicle's front edge.

3 Vehicle width line

Indicates the width of the vehicle including the outside rear view mirror.

4 Front wheel contact point

Shows the position of the vehicle's front tire.

تلفن شبانه روزی: ۰۲۱-۸۸۸۶۲۰۸۵

FarmaSOS.com

■ Side-rear simultaneous display monitor

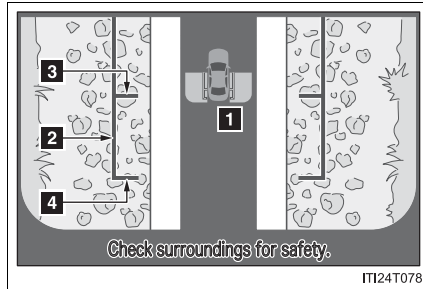

1 Vehicle icon

Displays the image being shown by the side-rear simultaneous display monitor.

2 Vehicle width line

Indicates the width of the vehicle including the outside rear view mirror.

3 Rear wheel contact point

Shows the position of the vehicle's rear tire.

4 Vehicle rear edge line

Shows the position of the vehicle's rear edge.

■ Rear monitor (Toyota park assist monitor)

Refer to "Navigation System Owner's Manual" تلفن شبانه روزی

2

When driving

ایراد خودرو فارما

FarmaSOS.com

2-4. Using other driving systems

Projected course line display mode (Wide view front & side monitor display)

▶ No course lines mode

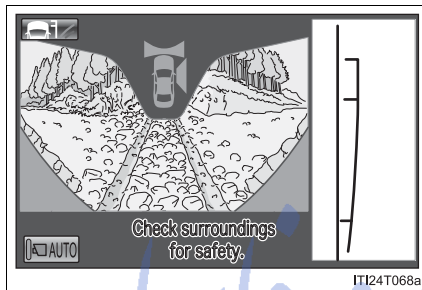

Vehicle width line displayed.

▶ Minimum projected turning circle display mode

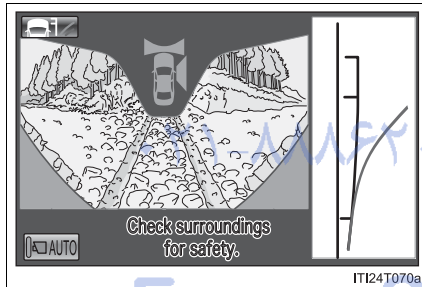

The minimum projected turning circle line is added to the no course lines mode.

▶ Turning course line display mode

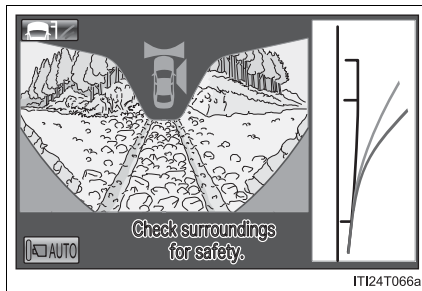

The projected course line is added to the minimum projected turning circle mode.

■ Switching projected course line display mode

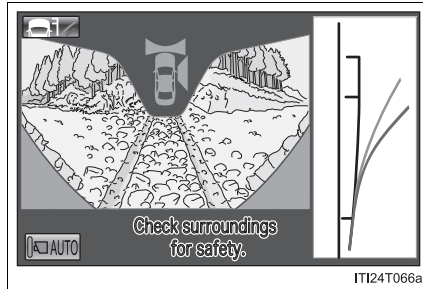

Touch  .

Turning course line display mode ←

↓
Minimum projected turning circle display mode

↓
No course lines mode

2

■ Using the vehicle width line & course line

▶ Vehicle width line

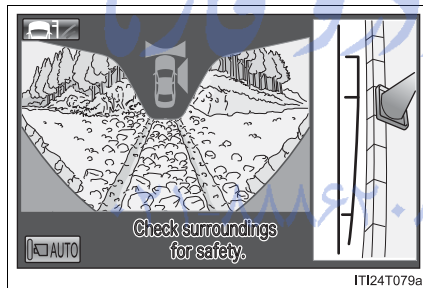

Use the vehicle width line to check the vehicle's distance from objects such as curbstones etc.

As shown in the illustration, be sure that the vehicle width line does not overlap the object. If you also move the vehicle so that the vehicle width line and the object are parallel, you can park parallel to the object.

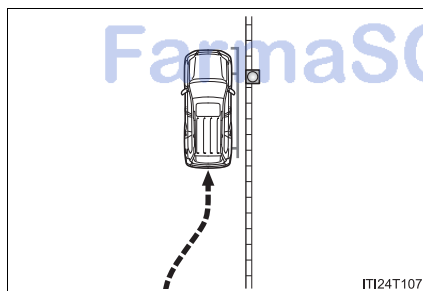

When driving

2-4. Using other driving systems

► Minimum projected turning circle & projected course line

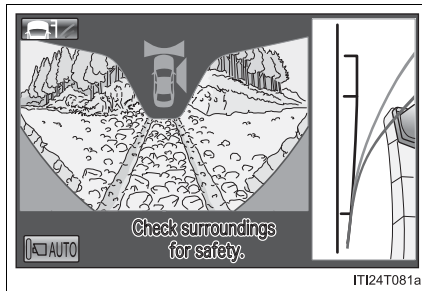

Use the minimum projected turning circle & projected course line (when displayed) to check the vehicle's path with relation to obstacles.

If the minimum projected turning circle line (blue) is over the obstacle as shown in the illustration, or the obstacle falls within the minimum projected turning circle, if you turn with the minimum possible turning circle, the vehicle may collide with the object.

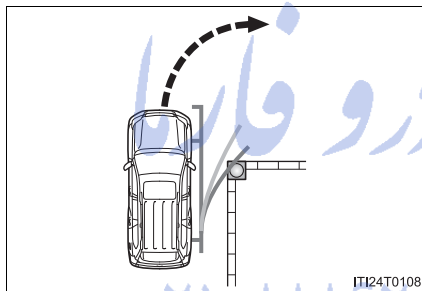

When the projected course line (yellow) is displayed, be sure to operate the steering wheel so that the obstacle stays outside the projected course line until the vehicle has passed the object.

■ **The Multi-terrain Monitor can be operated when**

▶ Normal display mode

The vehicle speed is less than approximately 7 mph (12 km/h).

▶ Automatic display mode

● When automatic display mode is selected

● When the shift lever is shifted to “D”, “S” or “N”

● When the shift lever is in “D”, “S” or “N” and the vehicle speed is below approximately 6 mph (10 km/h)

■ **Automatic system cancellation**

In the following situations, the image is canceled automatically.

● When the vehicle speed exceeds approximately 7 mph (12 km/h).

After the vehicle speed exceeds approximately 7 mph (12 km/h), the image will continue to be displayed for a short time.

If the vehicle speed returns to below 7 mph (12 km/h) before the image extinguishes, the image will continue to be displayed.

● When “MAP” or another switch outside the screen has been pressed

■ **Interruption screens**

An interruption screen is displayed when an obstacle is within the detection range of the intuitive parking assist. (→P. 229)

■ **When the door mirrors are folded.**

The screen will be turned off temporarily while the door mirrors are folding, and the screen will return to normal once folding has been completed.

2-4. Using other driving systems

■ Displayed area

The area covered by the camera is limited. Objects which are close to either corner of the bumper or under the bumper cannot be seen on the screen.

The area displayed on the screen may vary depending on vehicle orientation or road conditions.

► Front camera

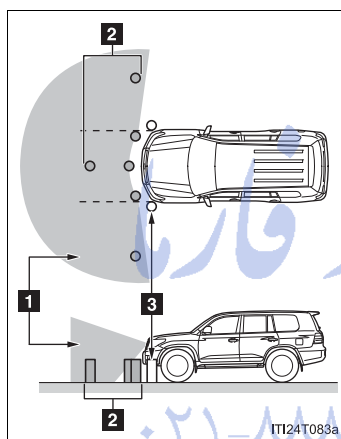

- 1 Camera's field of view
- 2 Objects visible to the camera
- 3 Objects not visible to the camera
- 4 Parts of the vehicle (bumper, grille, etc.)

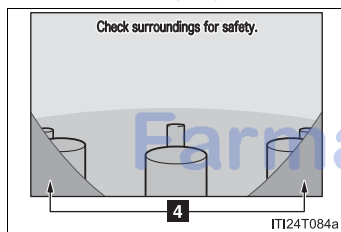

2-4. Using other driving systems

► Side camera (Wide view front & side monitor display)

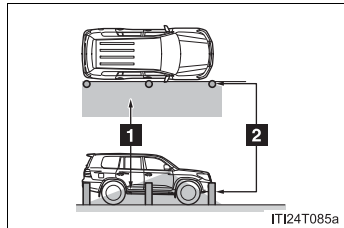

- 1 Camera's field of view
- 2 Objects visible to the camera
- 3 Right side of vehicle

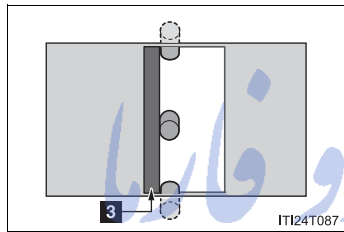

2

When driving

تلفن شبانه روزی: ۰۲۱-۸۸۸۶۲۰۸۵

FarmaSOS.com

2-4. Using other driving systems

► Side camera (side-front simultaneous display monitor)

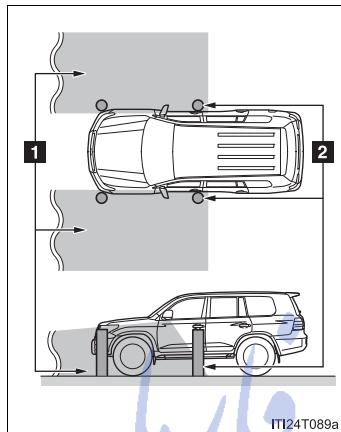

- 1** Camera's field of view
- 2** Objects visible to the camera
- 3** Right side of vehicle
- 4** Left side of vehicle

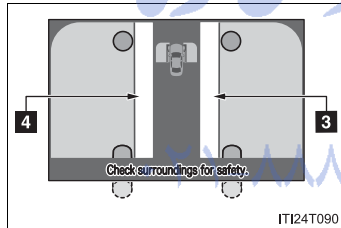

FarmaSOS.com

2-4. Using other driving systems

► Side camera (side-rear simultaneous display monitor)

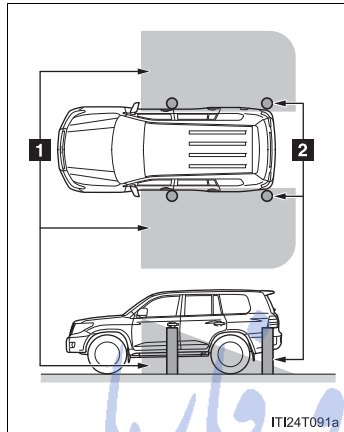

- 1 Camera's field of view
- 2 Objects visible to the camera
- 3 Right side of vehicle
- 4 Left side of vehicle

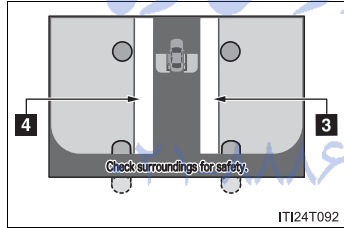

► Rear camera

Refer to the "Navigation System Owner's Manual"

2

When driving

2-4. Using other driving systems

■ Multi-terrain Monitor cameras

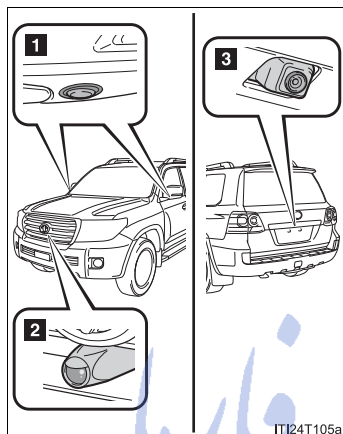

- 1 Side cameras
- 2 Front camera
- 3 Rear camera

In the following cases, it may be difficult to see images on the screen even when the system is functioning correctly:

- The vehicle is in a dark area, such as at night.
- The temperature near the lens is extremely high or low.
- Water droplets are on the camera lens or humidity is high, such as when it rains.
- Foreign matter, such as snow and mud, adheres to the camera lens.
- The camera has scratches or dirt on it.
- The sun or headlights are shining directly into the camera lens.
- The camera lens is damaged by flying stones.

■ **Smear effect**

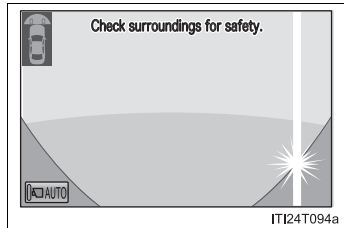

If a bright light, such as sunlight reflected off the vehicle body, is picked up by the camera, a smear effect* characteristic to the camera may occur.

*: Smear effect — A phenomenon that occurs when a bright light is picked up by the camera; when transmitted by the camera, the light source will appear to have streaks of light emanating from it. The streaks will also appear when the light source is in the vehicle icon area.

■ **Flicker effect**

When the camera is used under fluorescent lights, sodium lights, mercury lights etc., the lights and the illuminated areas may appear to flicker.

■ **Display settings**

Refer to the “Navigation System Owner’s Manual”

تلفن شبانه روزی: ۰۲۱-۸۸۸۶۲۰۸۵

FarmaSOS.com

2-4. Using other driving systems

■ If the message “System is initializing.” is displayed

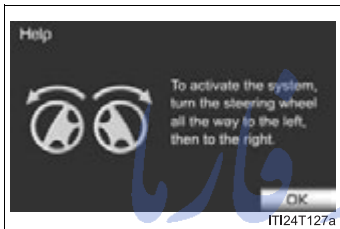
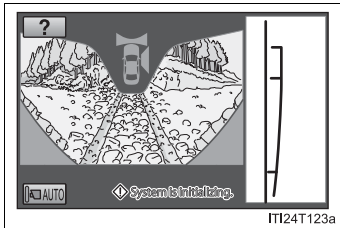

“System is initializing.” will be displayed on the screen under the following conditions:

- The battery has been reinstalled.
- The steering wheel has been moved while the battery was being reinstalled.
- Battery power is low.
- The steering sensor has been reinstalled.
- There is a malfunction in the signals being output by the steering sensor.

Initialize the system by performing either of the procedures below:

- Drive for a short period of time while keeping the steering wheel straight.
- Stop the vehicle, and turn the steering wheel as far as it will go to the left and right. On the system initialization screen, touch the “?” button to display the operating procedure.

If this does not resolve the symptom, have the vehicle inspected by your Toyota dealer.

⚠ CAUTION**■ When using the Multi-terrain Monitor system**

Observe the following precautions to avoid an accident that could result in death or serious injuries:

- Never depend solely on the monitor system.
- Always check visually and with the mirrors to confirm your intended path is clear.
- Depicted distances between objects and flat surfaces differ from actual distances.
- Do not use the system if the hood or doors are open.

■ Conditions which may affect the Multi-terrain Monitor system

- If the front or the rear of the vehicle or the outside rear view mirror has been hit, the camera's position and mounting angle may have changed. Have the vehicle inspected by your Toyota dealer.
- As the camera has a water proof construction, do not detach, disassemble or modify it. This may cause incorrect operation.
- Rapid temperature changes, such as when hot water is poured on the vehicle in cold weather, may cause the system to function abnormally.
- If the camera lens is dirty, it cannot transmit a clear image. Rinse with water and wipe with a soft cloth. If the camera lens is extremely dirty, wash with a mild cleanser and rinse.
- Do not strongly rub the camera lens. If the camera lens is scratched, it cannot transmit a clear image.
- Do not allow organic solvent, car wax, window cleaner or glass coat to adhere to the camera. If this happens, wipe it off as soon as possible.
- The displayed image may be darker and moving images may be slightly distorted when the system is cold.
- Situations unsuitable for Multi-terrain Monitor
 - On icy or slick road surfaces, or in snow
 - When using tire chains

2-4. Using other driving systems

CAUTION

■ Conditions which may affect the Multi-terrain Monitor system

- If the tires are changed, the position of the guide lines displayed on the screen may be incorrect. When changing the tires, consult your Toyota dealer.
- Depending on the circumstances of the vehicle (number of passengers, amount of luggage, etc.), the position of the guide lines displayed on the screen may change. Be sure to check visually behind and all around the vehicle before proceeding.
- Depending on the overall length of the vehicle (if a frontal protection system is installed or the bumper has been replaced, etc.), the position of the distance guidelines displayed on the front monitor may change. Be sure to check visually behind and all around the vehicle before proceeding.
- When washing the vehicle, do not apply intensive bursts of water to the camera or camera area. Doing so may result in the camera malfunctioning.

NOTICE

■ When using the Multi-terrain Monitor

- Even if an obstacle is no longer visible on the side monitor, do not turn the steering wheel further in the direction the vehicle is turning until the vehicle has moved completely past the obstacle. If the steering wheel is turned to full lock, the vehicle will turn in the smallest possible turning circle, and may collide with the obstacle.
- It may be difficult to judge distance with the image from the front camera due to the characteristics of the lens. Drive carefully while checking the actual distance to the obstacles displayed on the screen. Also, give your full attention to sudden bumps in the road.

2-4. Using other driving systems

Driving assist systems

To help enhance driving safety and performance, the following systems operate automatically in response to various driving situations. Be aware, however, that these systems are supplementary and should not be relied upon too heavily when operating the vehicle.

■ Multi Terrain ABS (Anti-lock Brake System)

Helps to prevent wheel lock when the brakes are applied suddenly, or if the brakes are applied while driving on a slippery road surface, or in off-road conditions (such as rough roads, sand and mud).

■ Brake assist

Generates an increased level of braking force after the brake pedal is depressed, when the system detects a panic stop situation.

■ VSC (Vehicle Stability Control)

Helps the driver to control skidding when swerving suddenly or turning on slippery road surfaces.

■ Active TRAC (Traction Control)

Helps to maintain drive power and prevent the 4 wheels from spinning when starting the vehicle or accelerating on slippery roads.

■ Hill-start assist control

Helps to prevent the vehicle from rolling backwards when starting on an incline or slippery slope.

■ KDSS (Kinetic Dynamic Suspension System)

KDSS helps to ensure ride comfort and handling response by using a hydraulic control system to control the suspension stabilizer bars in response to road surface and driving conditions during cornering or off-road driving.

■ VGRS (Variable Gear Ratio Steering) (if equipped)

Helps to adjust the wheel turning angle in accordance with the vehicle speed and steering wheel movement.

■ PCS (Pre-Collision System) (if equipped)

→P. 289

2-4. Using other driving systems

■ Trailer Sway Control

Helps the driver to control trailer sway by selectively applying brake pressure for individual wheels and reducing engine torque when trailer sway is detected.

Trailer Sway Control is part of the VSC system and will not operate if VSC turned off or experiences a malfunction.

When the VSC/Trailer Sway Control/Active TRAC/hill-start assist control systems are operating

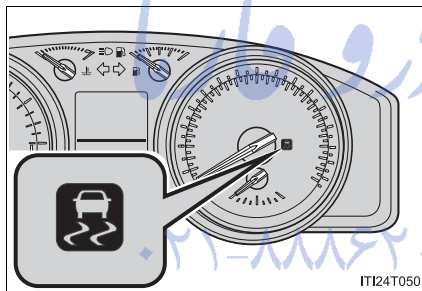

The slip indicator light flashes to indicate that the VSC/Trailer Sway Control/Active TRAC/hill-start assist control systems have been engaged.

The stop lights and high mounted stoplight turn on when the hill-start assist control system or Trailer Sway Control is operating.

FarmaSOS.com

To disable Active TRAC and/or VSC and Trailer Sway Control

If the vehicle gets stuck in fresh snow or mud, Active TRAC, VSC and Trailer Sway Control may reduce power from the engine to the wheels. You may need to turn the system off to enable you to rock the vehicle in order to free it.

■ Turning off Active TRAC

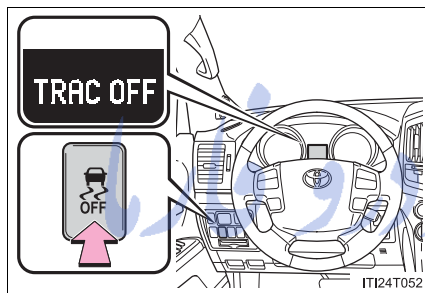

Quickly push and release the button to turn off Active TRAC.

The "TRAC OFF" will be shown on the multi-information display.

This mode can be used when the transfer mode is H4.

Push the button again to turn the system back on.

2

When driving

■ Turning off Active TRAC, VSC and Trailer Sway Control

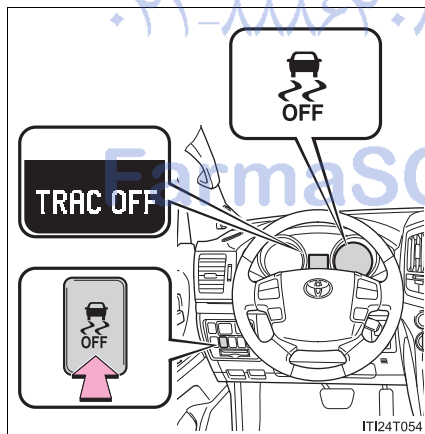

Push and hold the button for more than 3 seconds while the vehicle is stopped to turn off Active TRAC, VSC and Trailer Sway Control.

The VSC OFF indicator light will come on and the "TRAC OFF" will be shown on the multi-information display.

Push the button again to turn the system back on.

■ **When the message is displayed on the multi-information display showing that TRAC has been disabled even if the VSC OFF switch has not been pressed**

Active TRAC, hill-start assist control, Crawl Control cannot be operated. Contact your Toyota dealer.

■ **Automatic reactivation of Active TRAC, VSC and Trailer Sway Control**

Turning the "ENGINE START STOP" switch off after turning off the Active TRAC and VSC systems will automatically re-enable them.

■ **Automatic Active TRAC reactivation**

If only the Active TRAC system is turned off, the Active TRAC system will turn on when vehicle speed increases.

■ **Automatic Active TRAC, VSC and Trailer Sway Control reactivation**

If the Active TRAC, VSC and Trailer Sway Control are turned off, the systems will not turn on even when vehicle speed increases.

■ **If the brake system overheats**

The brake system may overheat. In this case, a buzzer will sound, and the "TRAC OFF" will be displayed on the multi-information display, and Active TRAC and hill-start assist control will be temporarily inoperable. In this event, stop the vehicle immediately in a safe place, and allow the brake system to cool down sufficiently until the "TRAC OFF" on the multi-information display go off. (There is no problem with continuing normal driving.)

FarmaSOS.com

■ **Sounds and vibrations caused by the Multi Terrain ABS, brake assist, Active TRAC, VSC, Trailer Sway Control, hill-start assist control and VGRS**

- A sound may be heard from the engine compartment when the engine is started or just after the vehicle begins to move. This sound does not indicate that a malfunction has occurred in any of these systems.
- Any of the following conditions may occur when the above systems are operating. None of these indicates that a malfunction has occurred.
 - Vibrations may be felt through the vehicle body and steering.
 - A motor sound may be heard after the vehicle comes to a stop.
 - The brake pedal may pulsate slightly after the Multi Terrain ABS is activated.
 - The brake pedal may move down slightly after the Multi Terrain ABS is activated.

■ **Hill-start assist control is operational when**

- The shift lever is in "D" or "S".
- The brake pedal is not depressed.

■ **VGRS is disabled in the following situations**

- During stopping or the steering wheel has been moved for a long time while driving at lower speeds.
- After the engine is restarted at less than -22°F (-30°C).
- If you disconnect the battery with the steering wheel turned, the center position of the steering wheel could be slightly and temporary hanged. To initialize the VGRS, drive for a short while.

2-4. Using other driving systems

CAUTION

Any of the following conditions may result in an accident which could cause death or serious injury:

■ **The Multi Terrain ABS does not operate effectively when**

- The limits of tire gripping performance have been exceeded (such as excessively worn tires on a snow covered road).
- The vehicle hydroplanes while driving at high speed on the wet or slick road.

■ **Stopping distance when the Multi Terrain ABS is operating may exceed that of normal conditions**

The Multi Terrain ABS is not designed to shorten the vehicle's stopping distance. Always maintain a safe distance from the vehicle in front of you, especially in the following situations.

- When driving on dirt, gravel or snow-covered roads
- When driving with tire chains
- When driving over bumps in the road
- When driving over roads with potholes or uneven roads

■ **Active TRAC may not operate effectively when**

Directional control and power may not be achievable while driving on slippery road surfaces, even if the Active TRAC is operating.

Do not drive the vehicle in conditions where stability and power may be lost.

■ **If the hill-start assist control does not operate effectively**

Do not overly rely on the hill-start assist control. The hill-start assist control may not operate effectively on steep inclines and roads covered in ice.

■ **When Active TRAC, VSC and Trailer Sway Control are off**

Be especially careful and drive at a speed appropriate to the road conditions. As there are systems to ensure vehicle stability and driving force, do not turn off Active TRAC, VSC and Trailer Sway Control unless necessary.

⚠ CAUTION**■ When the VSC and Trailer Sway Control are activated**

The slip indicator light flashes. Always drive carefully. Reckless driving may cause an accident. Exercise particular care when the indicator light flashes.

■ Replacing tires

Make sure that all tires are of the same size, brand, tread pattern and total load capacity. In addition, make sure that the tires are inflated to the specified tire pressure level.

The Multi Terrain ABS, Active TRAC, VSC and Trailer Sway Control will not function correctly if different tires are fitted on the vehicle. Contact your Toyota dealer for further information when replacing tires or wheels.

■ Handling of tires and suspension

Using tires with any kind of problem or modifying the suspension will affect the driving assist systems, and may cause the system to malfunction.

■ Trailer Sway Control precaution

The Trailer Sway Control system is not able to reduce trailer sway in all situations. Depending on many factors such as the conditions of the vehicle, trailer, road surface, and driving environment, the Trailer Sway Control system may not be effective. Refer to your trailer owner's manual for information on how to tow your trailer properly.

■ If trailer sway occurs

Observe the following precautions.
Failing to do so may cause death or serious injury.

- Firmly grip the steering wheel. Steer straight ahead.
Do not try to control trailer swaying by turning the steering wheel.
- Begin releasing the accelerator pedal immediately but very gradually to reduce speed.
Do not increase speed. Do not apply vehicle brakes.

If you make no extreme correction with the steering or brakes, your vehicle and trailer should stabilize. (→P. 328)

2-4. Using other driving systems

NOTICE

■ KDSS

In the following situations, there is the possibility that a system malfunction has occurred, and drive comfort and the vehicle's ability to travel on poor road surfaces may be reduced. Take the vehicle to your Toyota dealer immediately.

- When turning a corner, the vehicle's body seems to roll further than normal.
- If after the vehicle has been left in a slanted position for a long time, for example with the wheels of one side parked on a curb, the vehicle does not return to level when driving (the vehicle remains slanted to one side after returning the vehicle to level ground).

تلفن شبانه روزی: ۰۲۱-۸۸۶۲۰۸۵

FarmaSOS.com

2-4. Using other driving systems Pre-Collision System*

When a frontal collision seems likely, the system attempts to lessen vehicle's damage. Two types of pre-collision system are available. The brake-linked pre-collision system operates in conjunction with the braking operation of the driver. The radar type pre-collision system has a sensor that is used to detect an unavoidable frontal collision.

■ Pre-collision seat belts (front seats only)

▶ Brake-linked pre-collision system

Based on the speed and amount of the driver's braking operation, the system determines if emergency braking is being performed. If this determination is made, the seat belts are immediately retracted to increase the effectiveness of the pretensioners (→P. 80). In addition, the system also operates if the driver loses control of the vehicle.

▶ Radar type pre-collision system

If the pre-collision sensor detects that a collision is unavoidable, the pre-collision system will retract the seat belt before the collision occurs. The same will happen if the driver makes an emergency braking or loses control of the vehicle. (→P. 80)

However, when the VSC system is disabled, the system will not operate in the event of skidding.

■ Pre-collision brake assist (radar type only)

When there is a high possibility of a frontal collision, the system applies greater braking force in relation to how strongly the brake pedal is depressed.

*: If equipped

2-4. Using other driving systems

Radar sensor (radar type only)

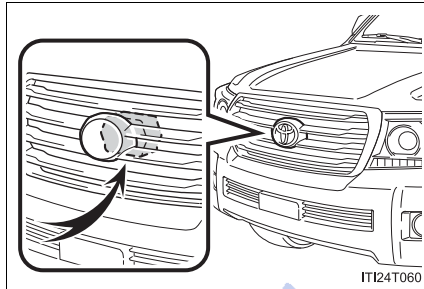

Detects vehicles or other obstacles on or near the road ahead and determines whether a collision is imminent based on the position, speed, and heading of the obstacles.

When traveling on a road with very light traffic and very little to reflect the radar waves emitted by the radar sensor, the system may decide that the radar sensor is dirty, even if the sensor is not actually dirty. The system will automatically restore itself when reflected radar waves are detected.

تلفن شبانه روزی: ۰۲۱-۸۸۸۶۲۰۸۵

FarmaSOS.com

■ **Obstacles not detected (radar type only)**

The sensor cannot detect plastic obstacles such as pylons. There may also be occasions when the radar sensor cannot detect pedestrians, animals, bicycles, motorcycles, trees, or snowdrifts.

■ **The pre-collision system is operational when**

- Pre-collision seat belts (situation 1)
 - Vehicle speed is greater than about 4 mph (5 km/h).
 - The speed at which your vehicle is approaching the obstacle or the vehicle running ahead of you is greater than about 19 mph (30 km/h).
 - The front occupants are wearing a seat belt.
- Pre-collision seat belts (situation 2)
 - Vehicle speed is greater than about 19 mph (30 km/h).
 - The system detects sudden braking or skidding.
 - The front occupants are wearing a seat belt.
- Pre-collision brake assist (radar type only)
 - Vehicle speed is greater than about 19 mph (30 km/h).
 - The speed at which your vehicle is approaching the obstacle or the vehicle running ahead of you is greater than about 19 mph (30 km/h).
 - The brake pedal is depressed.

2-4. Using other driving systems

■ Conditions that may trigger the system even if there is no possibility of collision

- When there is an object by the roadside at the entrance to a curve
- When passing an oncoming vehicle on a curve
- When driving over a narrow iron bridge
- When there is a metal object on the road surface
- When driving on an uneven road surface (nose up, nose down)
- When passing an oncoming vehicle on a left-turn
- When your vehicle rapidly closes on the vehicle in front
- When a grade separation/interchange, sign, billboard, or other structure appears to be directly in the vehicle's line of travel
- When climbing a steep hill causes an overhead billboard or other metallic structure to appear directly in the vehicle's line of travel
- When an extreme change in vehicle height occurs
- When the axis of the radar is out of adjustment
- When passing through certain toll gates
- When passing through an overpass
- When passing through a tunnel

When the system is activated in the situations described above there is also a possibility that the seat belts will retract quickly and the brakes will be applied with a force greater than normal. When the seat belt is locked in the retracted position, stop the vehicle in a safe place, release the seat belt and refasten.

■ **Situations in which the pre-collision system does not function properly**

The system may not function effectively in situations such as the following:

- On roads with sharp bends or uneven surfaces
- If a vehicle suddenly moves in front of your vehicle, such as at an intersection
- If a vehicle suddenly cuts in front of your vehicle, such as when overtaking
- In inclement weather such as heavy rain, fog, snow or sand storms
- When your vehicle is skidding such as the VSC system off
- When your vehicle is steeply inclined
- When the axis of the radar is out of adjustment

■ **Automatic cancelation of the pre-collision system**

When a malfunction occurs due to sensor contamination, etc. that results in the sensors being unable to detect obstacles, the pre-collision system will be automatically disabled. In this case, the system will not activate even if there is a collision possibility.

■ **When there is a malfunction in the system, or if the system is temporarily unusable**

Warning lights and/or warning messages will turn on or flash. (→P. 608, 619)

2-4. Using other driving systems

■ Certification (radar type only)

FCC ID: HYQDNMWR005

This device complies with part 15 of the FCC Rules. Operation is subject to the following two conditions: (1) This device may not cause harmful interference, and (2) this device must accept any interference received, including interference that may cause undesired operation.

FCC WARNING

Changes or modifications not expressly approved by the party responsible for compliance could void the user's authority to operate the equipment.

Radiofrequency radiation exposure Information:

This equipment complies with FCC radiation exposure limits set forth for an uncontrolled environment.

This equipment should be installed and operated with minimum distance of 20 cm between the radiator (antenna) and your body.

This transmitter must not be co-located or operating in conjunction with any other antenna or transmitter.

تلفن شبانه روزی: ۰۲۱-۸۸۶۲۰۸۵

FarmaSOS.com

⚠ CAUTION**■ Handling the radar sensor (radar type only)**

Observe the following to ensure the pre-collision system can function effectively.

- Keep the sensor and front grille clean at all times.
Clean the sensor and front grille with a soft cloth so you do not mark or damage them.
- Do not subject the sensor or surrounding area to a strong impact.
If the sensor moves even slightly off position, the system may become inaccurate or malfunction. If the sensor or surrounding area are subject to a strong impact, always have the area inspected and adjusted by your Toyota dealer.
- Do not disassemble the sensor.
- Do not attach accessories or stickers to the sensor, grille cover or surrounding area.
- Do not modify or paint the sensor and grille.

■ Limitations of the pre-collision system

Do not rely on the pre-collision system. Always drive safely, taking care to observe your surroundings and checking for any obstacles or other road hazards.

Failure to do so may cause an accident resulting in death or serious injury.

2-5. Driving information

Off-road precautions

This vehicle belongs to the utility vehicle class, which has higher ground clearance and narrower tread in relation to the height of its center of gravity to make it capable of performing in a wide variety of off-road applications.

Off-road vehicle feature

- Specific design characteristics give it a higher center of gravity than ordinary passenger cars. This vehicle design feature causes this type of vehicle to be more likely to rollover. And, utility vehicles have a significantly higher rollover rate than other types of vehicles.
- An advantage of the higher ground clearance is a better view of the road allowing you to anticipate problems.
- It is not designed for cornering at the same speeds as ordinary passenger cars any more than low-slung sports cars are designed to perform satisfactorily under off-road conditions. Therefore, sharp turns at excessive speeds may cause rollover.

FarmaSOS.com

⚠ CAUTION**■ Off-road vehicle precautions**

Always observe the following precautions to help minimize the risk of serious personal injury or damage to your vehicle:

- In a rollover crash, an unbelted person is significantly more likely to die than a person wearing a seat belt. Therefore, the driver and all passengers should fasten their seat belts whenever the vehicle is moving.
- Avoid sharp turns or abrupt maneuvers, if at all possible. Failure to operate this vehicle correctly may result in loss of control or vehicle rollover causing death or serious injury.
- Loading cargo on the roof luggage carrier will make the center of the vehicle gravity higher. Avoid high speeds, sudden starts, sharp turns, sudden braking or abrupt maneuvers, otherwise it may result in loss of control or vehicle rollover due to failure to operate this vehicle correctly.
- Always slow down in gusty crosswinds. Because of its profile and higher center of gravity, your vehicle is more sensitive to side winds than an ordinary passenger car. Slowing down will allow you to have better control.
- Do not drive horizontally across steep slopes. Driving straight up or straight down is preferred. Your vehicle (or any similar off-road vehicle) can tip over sideways much more easily than forward or backward.

2

When driving

FarmaSOS.com

Off-road driving

When driving your vehicle off-road, please observe the following precautions to ensure your driving enjoyment and to help prevent the closure of areas to off-road vehicles.

- Drive your vehicle only in areas where off-road vehicles are permitted to travel.
- Respect private property. Get owner's permission before entering private property.
- Do not enter areas that are closed. Honor gates, barriers and signs that restrict travel.
- Stay on established roads. When conditions are wet, driving techniques should be changed or travel delayed to prevent damage to roads.

■ Additional information for off-road driving

- ▶ For owners in U.S. mainland, Hawaii and Puerto Rico:

To obtain additional information pertaining to driving your vehicle off-road, consult the following organizations.

- State and Local Parks and Recreation Departments
- State Motor Vehicle Bureau
- Recreational Vehicle Clubs
- U.S. Forest Service and Bureau of Land Management

⚠ CAUTION**■ Off-road driving precautions**

Always observe the following precautions to help minimize the risk of serious personal injury or damage to your vehicle:

- Drive carefully when off the road. Do not take unnecessary risks by driving in dangerous places.
- Do not grip the steering wheel spokes when driving off-road. A bad bump could jerk the wheel and injure your hands. Keep both hands and especially your thumbs on the outside of the rim.
- Always check your brakes for effectiveness immediately after driving in sand, mud, water or snow.
- After driving through tall grass, mud, rock, sand, rivers, etc., check that there is no grass, bush, paper, rags, stone, sand, etc. adhering or trapped on the underbody. Clear off any such matter from the underbody. If the vehicle is used with these materials trapped or adhering to the underbody, a breakdown or fire could occur.
- When driving off-road or in rugged terrain, do not drive at excessive speeds, jump, make sharp turns, strike objects, etc. This may cause loss of control or vehicle rollover causing death or serious injury. You are also risking expensive damage to your vehicle's suspension and chassis.

2

When driving

FarmaSOS.com

 NOTICE

■ **To prevent the water damage**

Take all necessary safety measures to ensure that water damage to the engine or other components does not occur.

- Water entering the engine air intake will cause severe engine damage.
- Water entering the automatic transmission will cause deterioration in shift quality, locking up of your transmission accompanied by vibration, and ultimately damage.
- Water can wash the grease from wheel bearings, causing rusting and premature failure, and may also enter the differentials, transmission and transfer case, reducing the gear oil's lubricating qualities.

■ **When you drive through water**

If driving through water, such as when crossing shallow streams, first check the depth of the water and the bottom of the river bed for firmness. Drive slowly and avoid deep water.

■ **Inspection after off-road driving**

- Sand and mud that has accumulated in brake drums and around brake discs may affect braking efficiency and may damage brake system components.
- Always perform a maintenance inspection after each day of off-road driving that has taken you through rough terrain, sand, mud, or water. For scheduled maintenance information, refer to the "Scheduled Maintenance Guide" or "Owner's Manual Supplement".

2-5. Driving information Cargo and luggage

Take notice of the following information about storage precautions, cargo capacity and load.

- Stow cargo and luggage in the luggage compartment whenever possible.
- Be sure all items are secured in place.
- Be careful to keep the vehicle level. Placing the weight as far forward as possible helps maintain vehicle balance.
- For better fuel economy, do not carry unnecessary weight.

■ Roof luggage carrier (if equipped)

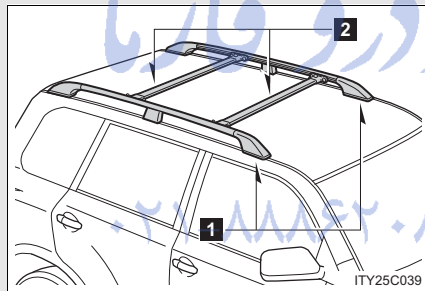

- 1 Roof rails
- 2 Cross rails

2

When driving

FarmaSOS.com

Adjusting the position of cross rails (if equipped)

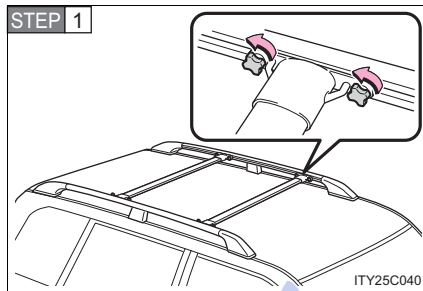

Turn the knobs counterclockwise to release the cross rails.

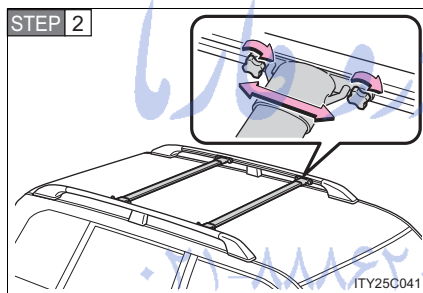

Slide the cross rails to the appropriate position for loading luggage and turn the knobs clockwise to tighten the cross rails securely.

FarmaSOS.com

Capacity and distribution

Cargo capacity depends on the total weight of the occupants.

(Cargo capacity) = (Total load capacity) - (Total weight of occupants)

Steps for Determining Correct Load Limit—

- (1) Locate the statement “The combined weight of occupants and cargo should never exceed XXX kg or XXX lbs.” on your vehicle’s placard.
- (2) Determine the combined weight of the driver and passengers that will be riding in your vehicle.
- (3) Subtract the combined weight of the driver and passengers from XXX kg or XXX lbs.
- (4) The resulting figure equals the available amount of cargo and luggage load capacity.

For example, if the “XXX” amount equals 1400 lbs. and there will be five 150 lb passengers in your vehicle, the amount of available cargo and luggage load capacity is 650 lbs. (1400 - 750 (5 × 150) = 650 lbs.)

- (5) Determine the combined weight of luggage and cargo being loaded on the vehicle.
That weight may not safely exceed the available cargo and luggage load capacity calculated in Step 4.
- (6) If your vehicle will be towing a trailer, load from your trailer will be transferred to your vehicle. Consult this manual to determine how this reduces the available cargo and luggage load capacity of your vehicle. (→P. 308)

2

When driving

Calculation formula for your vehicle

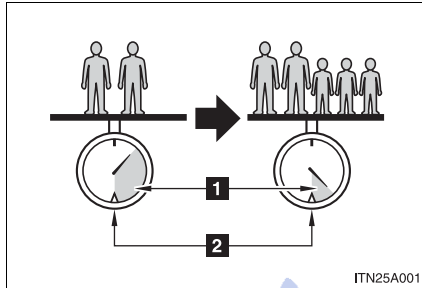

- 1** Cargo capacity
- 2** Total load capacity (vehicle capacity weight) (→P. 668)

When 2 people with the combined weight of A lb. (kg) are riding in your vehicle, which has a total load capacity (vehicle capacity weight) of B lb. (kg), the available amount of cargo and luggage load capacity will be C lb.(kg) as follows:

$$B^{*2} \text{ lb. (kg)} - A^{*1} \text{ lb. (kg)} = C^{*3} \text{ lb. (kg)}$$

*1:A = Weight of people

*2:B = Total load capacity

*3:C = Available cargo and luggage load

In this condition, if 3 more passengers with the combined weight of D lb. (kg) get on, the available cargo and luggage load will be reduced E lb. (kg) as follows:

$$C \text{ lb. (kg)} - D^{*4} \text{ lb. (kg)} = E^{*5} \text{ lb. (kg)}$$

*4:D = Additional weight of people

*5:E = Available cargo and luggage load

As shown in the example above, if the number of occupants increases, the cargo and luggage load equaling the combined weight of the occupants who got on later, by an amount. In other words, if an increase in the number of occupants causes an excess of the total load capacity (combined weight of occupants plus cargo and luggage load), you must reduce the cargo and luggage on your vehicle.

⚠ CAUTION**■ Things that must not be carried in the luggage compartment**

The following things may cause a fire if loaded in the luggage compartment.

- Receptacles containing gasoline
- Aerosol cans

■ Storage precautions

Observe the following precautions.

Failing to do so may result in death or serious injury.

- Stow cargo and luggage in the luggage compartment whenever possible.
- Do not stack anything in the luggage compartment higher than the seatbacks.
Such items may be thrown about and possibly injure people in the vehicle during sudden braking, sudden swerving or in an accident.
- Do not place cargo or luggage in or on the following locations as the item may get under the brake or accelerator pedal and prevent the pedals from being depressed properly, block the driver's vision, or hit the driver or passengers, causing an accident.
 - Feet of the driver
 - Front passenger or rear seats (when stacking items)
 - Instrument panel
 - Dashboard
 - Auxiliary box or tray that has no lid
- Secure all items in the occupant compartment, as they may shift and injure someone during sudden braking, sudden swerving or an accident.
- When you fold down the rear seats, long items should not be placed directly behind the front seats.
- Never allow anyone to ride in the luggage compartment. It is not designed for passengers. They should ride in their seats with their seat belts properly fastened. Otherwise, they are much more likely to suffer death or serious injury, in the event of sudden braking, sudden swerving or an accident.

 CAUTION

■ **Weight of the load**

- Do not exceed the maximum axle weight rating or the total vehicle weight rating.
- Even if the total load of occupant's weight and the cargo load is less than the total load capacity, do not apply the load unevenly. Improper loading may cause deterioration of steering or braking control which may cause death or serious injury.

■ **Roof luggage carrier precautions**

To use the roof rails as a roof luggage carrier, you must fit the roof rails with two or more genuine Toyota cross rails or their equivalent.

When you load cargo on the roof luggage carrier, observe the following:

- Place the cargo so that its weight is distributed evenly between the front and rear axles.
- If loading long or wide cargo, never exceed the vehicle overall length or width. (→P. 430)
- Before driving, make sure the cargo is securely fastened on the roof luggage carrier.
- Loading cargo on the roof luggage carrier will make the center of the vehicle gravity higher. Avoid high speeds, sudden starts, sharp turns, sudden braking or abrupt maneuvers, otherwise it may result in loss of control or vehicle rollover due to failure to operate this vehicle correctly and result in death or serious injury.
- If driving for a long distance, on rough roads, or at high speeds, stop the vehicle now and then during the trip to make sure the cargo remains in its place.
- Do not exceed 154 lb. (70 kg) cargo weight on the roof luggage carrier.

 CAUTION

■ **Cross rail adjustment**

Make sure the cross rails are locked securely by pushing forward and rearward them.
Failure to do so may cause an accident or serious injury in the event of emergency braking or a collision.

 NOTICE

■ **Cross rail adjustment**

Do not remove the cross rail stoppers, or the moon roof may be damage when it is tilted.

■ **When loading the luggage**

Be careful not to scratch the surface of the moon roof.

2

When driving

تلفن شبانه روزی: ۰۲۱-۸۸۶۲۰۸۵

FarmaSOS.com

2-5. Driving information

Vehicle load limits

Vehicle load limits include total load capacity, seating capacity, TWR (Trailer Weight Rating) and cargo capacity.

■ **Total load capacity (vehicle capacity weight): →P. 668**

Total load capacity means the combined weight of occupants, cargo and luggage.

■ **Seating capacity: 8 occupants (Front 2, Rear 6)**

Seating capacity means the maximum number of occupants whose estimated average weight is 150 lb. (68 kg) per person.

Even if the number of occupants are within the seating capacity, do not exceed the total load capacity.

■ **TWR (Trailer Weight Rating): →P. 319, 668**

TWR means the maximum gross trailer weight (trailer weight plus its cargo weight) that your vehicle is able to tow.

■ **Cargo capacity**

Cargo capacity may increase or decrease depending on the weight and the number of occupants.

■ **Total load capacity and seating capacity**

These details are also described on the tire and loading information label. (→P. 553)

 **CAUTION**

■ **Overloading the vehicle**

Do not overload the vehicle.

It may not only cause damage to the tires, but also degrade steering and braking ability, resulting in an accident.

2-5. Driving information

Winter driving tips

Carry out the necessary preparations and inspections before driving the vehicle in winter. Always drive the vehicle in a manner appropriate to the prevailing weather conditions.

■ Pre-winter preparations

- Use fluids that are appropriate to the prevailing outside temperatures.
 - Engine oil
 - Engine coolant
 - Washer fluid
- Have a service technician inspect the condition of the battery.
- Have the vehicle fitted with four snow tires or purchase a set of tire chains for the rear tires.

Ensure that all tires are the same size and brand, and that chains match the size of the tires.

2

When driving

تلفن شبانه روزی: ۰۲۱-۸۸۶۲۰۸۵

FarmaSOS.com

2-5. Driving information

■ Before driving the vehicle

Perform the following according to the driving conditions.

- Do not try to forcibly open a window or move a wiper that is frozen. Pour warm water over the frozen area to melt the ice. Wipe away the water immediately to prevent it from freezing.
- To ensure proper operation of the climate control system fan, remove any snow that has accumulated on the air inlet vents in front of the windshield.
- Check for and remove any excess ice or snow that may have accumulated on the exterior lights, vehicle's roof, chassis, around the tires or on the brakes.
- Remove any snow or mud from the bottom of your shoes before getting in the vehicle.

■ When driving the vehicle

Accelerate the vehicle slowly, keep a safe distance between you and the vehicle ahead, and drive at a reduced speed suitable to road conditions.

■ When parking the vehicle

Park the vehicle and move the shift lever to "P" without setting the parking brake. The parking brake may freeze up, preventing it from being released. If necessary, block the wheels to prevent inadvertent sliding or creeping.

Selection tire chains

Use the correct tire chain size when mounting the tire chains.
Chain size is regulated for each tire size.

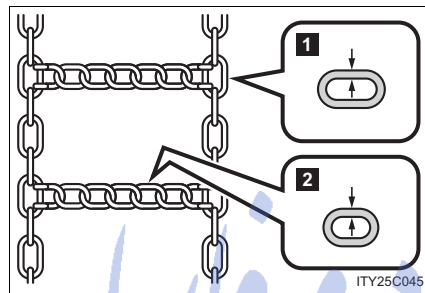

- 1** Side chain
(0.20 in. [5 mm] in diameter)
- 2** Cross chain
(0.25 in. [6.3 mm] in diameter)

2

When driving

Regulations on the use of tire chains

- Regulations regarding the use of tire chains vary according to location and type of road. Always check local regulations before installing chains.
- Retighten the chains after driving 1/4 - 1/2 mile (0.5 - 1.0 km).

■ Tire chains

Observe the following precautions when installing and removing chains.

- Install and remove tire chains in a safe location.
- Install tire chains on the rear tires only. Do not install the chains on the front tires.
- Install tire chains following the instructions provided in the accompanying manual.

 CAUTION

■ **Driving with snow tires**

Observe the following precautions to reduce the risk of accidents. Failing to do so may result in a loss of vehicle control and cause death or serious injury.

- Use tires of the size specified for your vehicle.
- Maintain the recommended level of tire inflation pressure.
- Do not drive in excess of 75 mph (120 km/h), regardless of the type of snow tires being used.
- Snow tires should be installed on all wheels.

■ **Driving with tire chains**

Observe the following precautions to reduce the risk of accidents. Failing to do so may result in the vehicle being unable to be driven safely, and may cause death or serious injury.

- Do not drive in excess of the speed limit specified for the tire chains being used, or 30 mph (50 km/h), whichever is lower.
- Avoid driving on bumpy road surfaces or over potholes.
- Avoid sudden acceleration, abrupt steering, sudden braking and shifting operations that cause sudden engine braking.
- Slow down sufficiently before entering a curve to ensure that vehicle control is maintained.

 NOTICE

■ **Repairing or replacing snow tires**

Request repairs or replacement of snow tires from Toyota dealers or legitimate tire retailers.

This is because the removal and attachment of snow tires affects the operation of the tire pressure warning valves and transmitters.

■ **Fitting tire chains**

The tire pressure warning valves and transmitters may not function correctly when tire chains are fitted.

2

When driving

امداد خودرو فارما

تلفن شبانه روزی: ۰۲۱-۸۸۸۶۲۰۸۵

FarmaSOS.com

2-5. Driving information

Trailer towing

Your vehicle is designed primarily as a passenger-and-load-carrying vehicle. Towing a trailer can have an adverse impact on handling, performance, braking, durability, and fuel consumption. For your safety and the safety of others, you must not overload your vehicle or trailer. You must also ensure that you are using appropriate towing equipment, that the towing equipment has been installed correctly and used properly, and that you employ the requisite driving habits.

Vehicle-trailer stability and braking performance are affected by trailer stability, brake performance and setting, trailer brakes, the hitch and hitch systems (if equipped).

To tow a trailer safely, use extreme care and drive the vehicle in accordance with your trailer's characteristics and operating conditions.

Toyota warranties do not apply to damage or malfunction caused by towing a trailer for commercial purposes.

Contact your Toyota dealer for further information about additional requirements such as towing kits, etc.

FarmaSOS.com

Towing related terms

■ **GCWR (Gross Combination Weight Rating)**

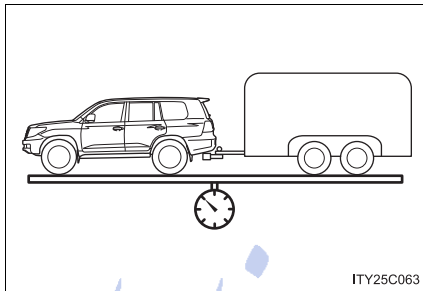

The maximum allowable gross combination weight. The gross combination weight is the sum of the total vehicle weight (including the occupants, cargo and any optional equipment installed on the vehicle) and the weight of the trailer being towed (including the cargo in the trailer).

■ **GVWR (Gross Vehicle Weight Rating)**

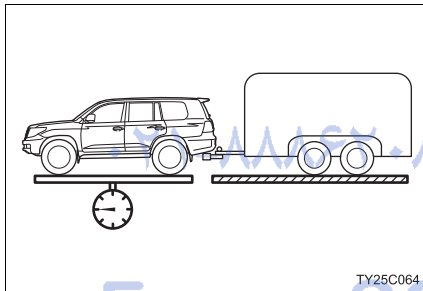

The maximum allowable gross vehicle weight. The gross vehicle weight is the total weight of the vehicle. When towing a trailer, it is the sum of the vehicle weight (including the occupants, cargo and any optional equipment installed on the vehicle) and the tongue weight.

■ **GAWR (Gross Axle Weight Rating)**

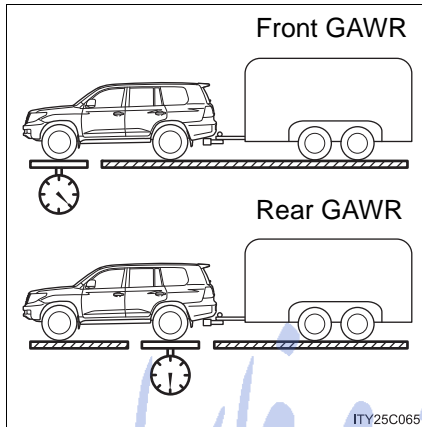

The maximum allowable gross axle weight. The gross axle weight is the load placed on each axle (front and rear).

■ **TWR (Trailer Weight Rating)**

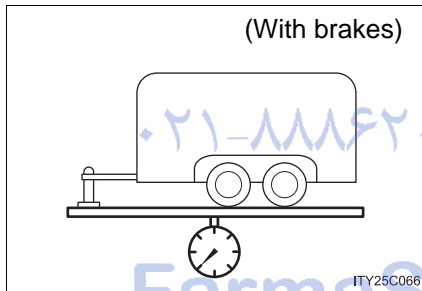

The maximum allowable gross trailer weight. The gross trailer weight is the sum of the trailer weight and the weight of the cargo in the trailer.

TWR is calculated assuming base vehicle with one driver, one front passenger, towing package, hitch and hitch systems (if required).

Additional optional equipment, passengers and cargo in the vehicle will reduce the trailer weight rating so as not to exceed GCWR, GVWR and GAWR.

If the gross trailer weight exceeds 3000 lb. (1360 kg), it is recommended to use a trailer with 2 or more axles.

■ **Unbraked TWR (Unbraked Trailer Weight Rating)**

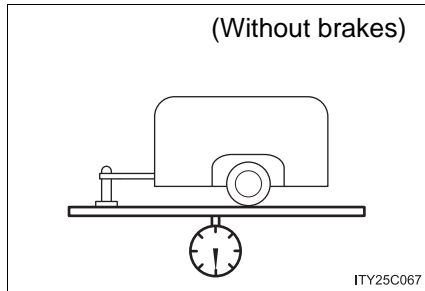

The trailer weight rating for towing a trailer without a trailer service brake system.

■ **Tongue Weight**

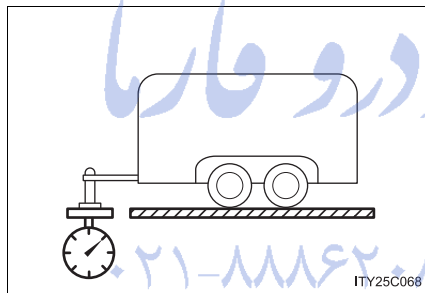

The load placed on the trailer hitch ball. (→P. 320)

2

When driving

FarmaSOS.com

Weight limits

- The gross trailer weight must never exceed 8100 lb. (3670 kg)
- The gross combination weight must never exceed 14400 lb. (6532 kg)

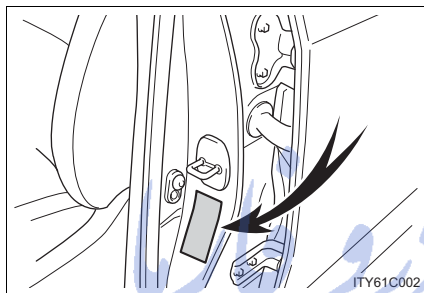

- The gross vehicle weight must never exceed the GVWR indicated on the Certification Label.
- The gross axle weight on each axle must never exceed the GAWR indicated on the Certification Label.
- If the gross trailer weight is over the unbraked TWR, trailer service brakes are required.
- If the gross trailer weight is over 2000 lb. (907 kg), a sway control device with sufficient capacity is required.
- If the gross trailer weight is over 5000 lb. (2268 kg), a weight distributing hitch with sufficient capacity is required.

GCWR, TWR, Unbraked TWR, Fifth wheel and Gooseneck towing TWR

Confirm that the gross trailer weight, gross combination weight, gross vehicle weight, gross axle weight and tongue weight are all within the limits.

- **GCWR***
14400 lb. (6532 kg)
- **TWR***
8100 lb. (3670 kg)
- **Unbraked TWR***
1000 lb. (454 kg)

2

When driving

تلفن شبانه روزی: ۰۲۱-۸۸۸۶۲۰۸۵

FarmaSOS.com

*: This model meets the tow-vehicle trailering requirement of SAE International per SAE J2807.

Trailer Tongue Weight

- A recommended tongue weight varies in accordance with the types of trailers or towing as described below.
- To ensure the recommended values shown below, the trailer must be loaded by referring to the following instructions.

- Tongue Weight

The gross trailer weight should be distributed so that the tongue weight is 9% to 11%. (Tongue weight /Gross trailer weight x 100 = 9% to 11%)

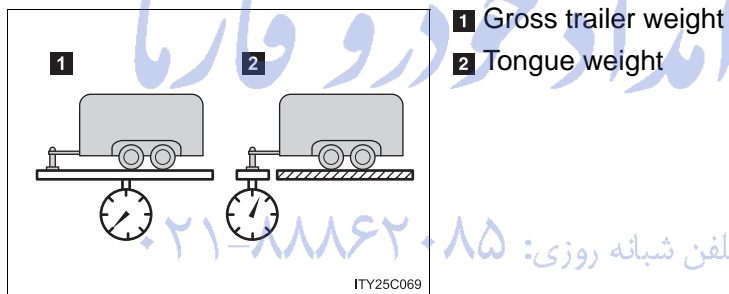

If using a weight distributing hitch when towing, return the front axle to the same weight as before the trailer connection.

If front axle weight cannot be measured directly, measure the front fender height above the front axle before connection. Adjust weight distributing hitch torque until front fender is returned to the same height as before connection.

The gross trailer weight, gross axle weight and tongue weight can be measured with platform scales found at a highway weighing station, building supply company, trucking company, junk yard, etc.

Hitch

Trailer hitch assemblies have different weight capacities. Toyota recommends the use of Toyota hitch/bracket for your vehicle. For details, contact your Toyota dealer.

- If you wish to install a trailer hitch, contact your Toyota dealer.
- Use only a hitch that conforms to the gross trailer weight requirement of your vehicle.
- Follow the directions supplied by the hitch manufacturer.
- Lubricate the hitch ball with a light coating of grease.
- Remove the trailer hitch whenever you are not towing a trailer. After removing the hitch, seal any mounting hole in the vehicle body to prevent entry of any substances into the vehicle.

2

When driving

Removing hitch cover

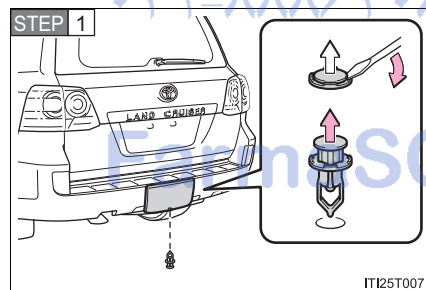

Remove the clip.

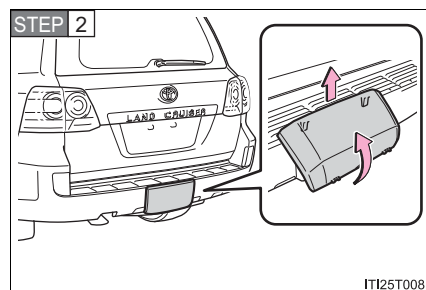

Grasp the lower edge of the hitch cover and raise the cover.

When reattaching the cover, reverse the steps listed.

Selecting trailer ball

Use the correct trailer ball for your application.

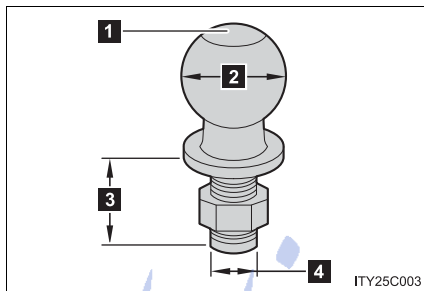

1 Trailer ball load rating

Matches or exceeds the gross trailer weight rating of the trailer.

2 Ball diameter

Matches the size of the trailer coupler. Most couplers are stamped with the required trailer ball size.

Trailer class	Typical trailer ball size
IV	2 5/16 in.
II and III	2 in.
I	1 7/8 in.

3 Shank length

Protrudes beyond the bottom of the lock washer and nut by at least 2 threads.

4 Shank diameter

Matches the ball mount hole diameter size.

Positions for towing hitch receiver

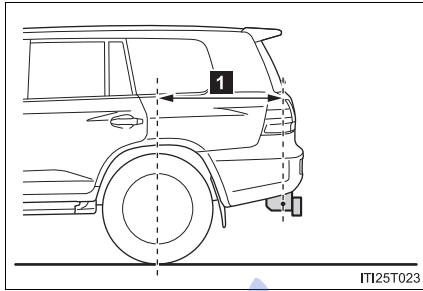

1 Hitch receiver pin hole position: 45.3 in. (1151 mm)

Connecting trailer lights

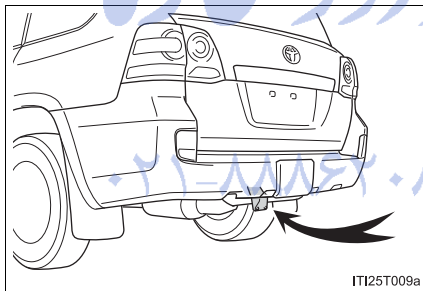

Use the wire harness stored in the rear end under the vehicle body.

Please consult your dealer when installing trailer lights, as incorrect installation may cause damage to the vehicle's lights. Please take care to comply with your state's laws when installing trailer lights.

2

When driving

Trailer towing tips

Your vehicle will handle differently when towing a trailer. Help to avoid an accident, death or serious injury, keep the following in mind when towing:

- Speed limits for towing a trailer vary by state or province. Do not exceed the posted towing speed limit.
- Toyota recommends that the vehicle-trailer speed limit is 65 mph (104 km/h) on a flat, straight, dry road. Do not exceed this limit, the posted towing speed limit or the speed limit for your trailer as set forth in your trailer owner's manual, whichever is lowest. Instability of the towing vehicle-trailer combination (trailer sway) increases as speed increases. Exceeding speed limits may cause loss of control.
- Before starting out, check the trailer lights, tires and the vehicle-trailer connections. Recheck after driving a short distance.
- Practice turning, stopping and reversing with the trailer attached in an area away from traffic until you become accustomed to the feel of the vehicle-trailer combination.
- Reversing with a trailer attached is difficult and requires practice. Grip the bottom of the steering wheel and move your hand to the left to move the trailer to the left. Move your hand to the right to move the trailer to the right. (This is generally opposite to reversing without a trailer attached.) Avoid sharp or prolonged turning. Have someone guide you when reversing to reduce the risk of an accident.
- As stopping distance is increased when towing a trailer, vehicle-to-vehicle distance should be increased. For each 10 mph (16 km/h) of speed, allow at least one vehicle and trailer length.
- Avoid sudden braking as you may skid, resulting in the trailer jack-knifing and loss of vehicle control. This is especially true on wet or slippery surfaces.

- Avoid jerky starts or sudden acceleration.
- Avoid jerky steering and sharp turns, and slow down before making a turn.
- Note that when making a turn, the trailer wheels will be closer than the vehicle wheels to the inside of the turn. Compensate by making a wider than normal turning radius.
- Slow down before making a turn, in crosswinds, on wet or slippery surfaces, etc.
Increasing vehicle speed can destabilize the trailer.
- Take care when passing other vehicles. Passing requires considerable distance. After passing a vehicle, do not forget the length of your trailer, and be sure you have plenty of room before changing lanes.
- To maintain engine braking efficiency and charging system performance, when using engine braking, do not put the transmission in "D". If in the S mode, the transmission shift range position must be in 5 or lower.
- Instability happens more frequently when descending steep or long downhill grades. Before descending, slow down and downshift. Do not make sudden downshifts while descending steep or long downhill grades.
- Avoid holding the brake pedal down too long or applying the brakes too frequently. This could cause the brakes to overheat and result in reduced braking efficiency.
- Due to the added load of the trailer, your vehicle's engine may overheat on hot days (at temperatures over 85°F [30°C]) when driving up a long or steep grade. If the engine coolant temperature gauge indicates overheating, immediately turn off the air conditioning (if in use), pull your vehicle off the road and stop in a safe spot. (→P. 659)

2-5. Driving information

- Always place wheel blocks under both the vehicle's and the trailer's wheels when parking. Apply the parking brake firmly, and put the transmission in "P". Avoid parking on a slope, but if unavoidable, do so only after performing the following:

STEP 1 Apply the brakes and keep them applied.

STEP 2 Have someone place wheel blocks under both the vehicle's and trailer's wheels.

STEP 3 When the wheel blocks are in place, release the brakes slowly until the blocks absorb the load.

STEP 4 Apply the parking brake firmly.

STEP 5 Shift into "P" and turn off the engine.

- When restarting after parking on a slope:

STEP 1 With the transmission in "P", start the engine. Be sure to keep the brake pedal pressed.

STEP 2 Shift into "D" or "R" (if reversing).

STEP 3 Release the parking brake and brake pedal, and slowly pull or back away from the wheel blocks. Stop and apply the brakes.

STEP 4 Have someone retrieve the blocks.

FarmaSOS.com

■ Matching trailer ball height to trailer coupler height

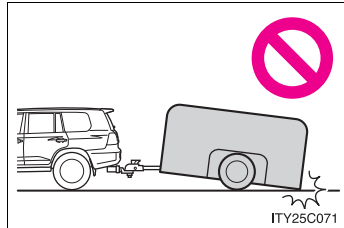

No matter which class of tow hitch applies, for a more safe trailer hookup, the trailer ball setup must be the proper height for the coupler on the trailer.

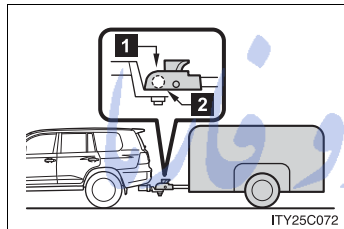

- 1 Coupler
- 2 Trailer ball

■ Before towing

Check that the following conditions are met:

- Ensure that your vehicle's tires are properly inflated. (→P. 676)
- Trailer tires are inflated according to the trailer manufacturer's recommendation.
- All trailer lights work as required by law.
- All lights work each time you connect them.
- The trailer ball is set at the proper height for the coupler on the trailer.
- The trailer is level when it is hitched.
Do not drive if the trailer is not level, and check for improper tongue weight, overloading, worn suspension, or other possible causes.
- The trailer cargo is securely loaded.
- The rear view mirrors conform to all applicable federal, state/provincial or local regulations. If they do not, install rear view mirrors appropriate for towing purposes.

■ Break-in schedule

If your vehicle is new or equipped with any new power train components (such as an engine, transmission, differential or wheel bearing), Toyota recommends that you do not tow a trailer until the vehicle has been driven for over 500 miles (800 km).

After the vehicle has been driven for over 500 miles (800 km), you can start towing. However, for the next 500 miles (800 km), drive the vehicle at a speed of less than 50 mph (80 km/h) when towing a trailer, and avoid full throttle acceleration.

■ Maintenance

- If you tow a trailer, your vehicle will require more frequent maintenance due to the additional load. (See “Owner’s Warranty Information Booklet” or “Scheduled Maintenance Guide/Owner’s Manual Supplement”.)
- Retighten the fixing bolts of the towing ball and bracket after approximately 600 miles (1000 km) of trailer towing.

■ If trailer sway occurs

One or more factors (crosswinds, passing vehicles, rough roads, etc.) can adversely affect handling of your vehicle and trailer, causing instability.

- If trailer swaying occurs:
 - Firmly grip the steering wheel. Steer straight ahead.
Do not try to control trailer swaying by turning the steering wheel.
 - Begin releasing the accelerator pedal immediately but very gradually to reduce speed.
Do not increase speed. Do not apply vehicle brakes.

If you make no extreme correction with the steering or brakes, your vehicle and trailer should stabilize. (if enabled, Trailer Sway Control can also help to stabilize the vehicle and trailer.)

- After the trailer swaying has stopped:
 - Stop in a safe place. Get all occupants out of the vehicle.
 - Check the tires of the vehicle and the trailer.
 - Check the load in the trailer.
Make sure the load has not shifted.
Make sure the tongue weight is appropriate, if possible.
 - Check the load in the vehicle.
Make sure the vehicle is not overloaded after occupants get in.

If you cannot find any problems, the speed at which trailer swaying occurred is beyond the limit of your particular vehicle-trailer combination. Drive at a lower speed to prevent instability. Remember that swaying of the towing vehicle-trailer increases as speed increases.

CAUTION

■ Trailer towing precautions

To tow a trailer safely, use extreme care and drive the vehicle in accordance with the trailer's characteristics and operating conditions. Failure to do so could cause an accident resulting in death or serious injury. Vehicle stability and braking performance are affected by trailer stability, brake setting and performance, and the hitch. Your vehicle will handle differently when towing a trailer.

■ To avoid accident or injury

- Do not exceed the TWR, unbraked TWR, GCWR, GVWR or GAWR.
- If the gross trailer weight is over 2000 lb. (907 kg), a sway control device with sufficient capacity is required.
- If the gross trailer weight is over 5000 lb. (2268 kg), a weight distributing hitch with sufficient capacity is required.
- Adjust the tongue weight within the appropriate range. Place heavier loads as close to the trailer axle as possible.
- Do not exceed 65 mph (104 km/h), the posted towing speed limit or the speed limit for your trailer as set forth in your trailer owner's manual, whichever is lowest. Slow down sufficiently before making a turn, in crosswinds, on wet or slippery surface, etc. to help avoid an accident. If you experience a vehicle-trailer instability from reducing a certain speed, slow down and make sure you keep your vehicle speed under the speed of which you experience the instability.
- Do not make jerky, abrupt or sharp turns.
- Do not apply the brakes suddenly as you may skid, resulting in jackknifing and loss of vehicle control. This is especially true on wet or slippery surfaces.

 CAUTION

■ **To avoid accident or injury**

- Do not exceed the trailer hitch assembly weight, gross vehicle weight, gross axle weight and trailer tongue weight capacities.
- Do not use cruise control when towing.
- Slow down and downshift before descending steep or long downhill grades. Do not make sudden downshifts while descending steep or long downhill grades.
- Vehicle-trailer instability is more likely on steep long down hills. Before descending steep or long downhill grades, slow down and downshift. Do not make sudden downshifts when descending steep or long downhill grades. Avoid holding the brake pedal down too long or applying the brakes too frequently. This could cause the brakes to overheat and result in reduced braking efficiency.

■ **Hitch**

Trailer hitch assemblies have different weight capacities established by the hitch manufacturer. Even though the vehicle may be physically capable of towing a higher weight, the operator must determine the maximum weight rating of the particular hitch assembly and never exceed the maximum weight rating specified for the trailer-hitch. Exceeding the maximum weight rating set by the trailer-hitch manufacturer can cause an accident resulting in death or serious personal injuries.

■ **When towing a trailer**

Toyota recommends trailers with brakes that conform to any applicable federal and state/provincial regulations.

- If the gross trailer weight exceeds unbraked TWR, trailer brakes are required. Toyota recommends trailers with brakes that conform to all applicable federal and state/provincial regulations.
- Never tap into your vehicle's hydraulic system, as this will lower the vehicle's braking effectiveness.
- Never tow a trailer without using a safety chain securely attached to both the trailer and the vehicle. If damage occurs to the coupling unit or hitch ball, there is danger of the trailer wandering into another lane.

 NOTICE

■ **When installing a trailer hitch**

Use only the position recommended by your Toyota dealer. Do not install the trailer hitch on the bumper; this may cause body damage.

■ **Do not directly splice trailer lights**

Do not directly splice trailer lights. Directly splicing trailer lights may damage your vehicle's electrical system and cause a malfunction.

2

When driving

امداد خودرو فارما

تلفن شبانه روزی: ۰۲۱-۸۸۸۶۲۰۸۵

FarmaSOS.com

2-5. Driving information Dinghy towing

Your vehicle is not designed to be dinghy towed (with 4 wheels on the ground) behind a motor home.

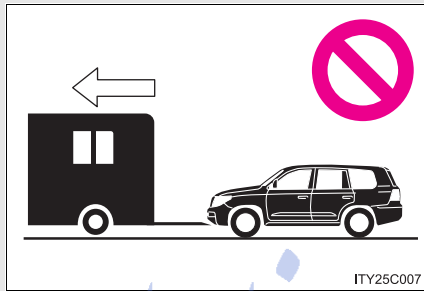

 NOTICE

■ To avoid serious damage to your vehicle

Do not tow your vehicle with four wheels on the ground.

تلفن شبانه روزی: ۰۲۱-۸۸۶۲۰۸۵

FarmaSOS.com

امداد خودرو فارما

تلفن شبانه روزی: ۰۲۱-۸۸۸۶۲۰۸۵

FarmaSOS.com

3-1. Using the air conditioning system and defogger

Front air conditioning system 336

Rear air conditioning system 347

Rear window and outside rear view mirror defoggers 351

Windshield wiper de-icer 352

3-2. Using the audio system

Audio system type 353

Using the radio 356

Using the CD player 365

Playing back MP3 and WMA discs 373

Operating an iPod 380

Operating a USB memory 387

Optimal use of the audio system 395

Using the AUX port 397

Using the steering switches 398

3-3. Using the Bluetooth® audio system

Bluetooth® audio system 402

Using the Bluetooth® audio system..... 406

Operating a Bluetooth® enabled portable player 412

Setting up a Bluetooth® enabled portable player 415

Bluetooth® audio system setup 422

3-4. Using the hands-free system (for cellular phone)

Hands-free system (for cellular phone)..... 423

Using the hands-free system 428

Making a phone call 436

Setting a cellular phone 441

Security and system setup 447

Using the phone book 453

3-5. Using the interior lights

Interior lights list 462

- Interior lights 463
- Personal lights 464

3-6. Using the storage features

List of storage features 466

- Glove box..... 467
- Console box..... 468
- Overhead console..... 469
- Cup holders 470
- Bottle holders..... 472
- Card holders 474
- Auxiliary boxes..... 474

3-7. Other interior features

Cool box..... 475

Sun visors 477

Vanity mirror..... 478

Clock 479

Outside temperature display..... 480

Ashtrays 482

Cigarette lighter..... 484

Power outlets 485

Heated steering wheel 487

Seat heaters and ventilators 489

Armrest 491

Assist grips..... 492

Floor mats 493

Luggage compartment features 495

Garage door opener..... 497

Safety Connect 504

3-1. Using the air conditioning system and defogger Front air conditioning system

Airflow and outlets are automatically adjusted according to the temperature setting.

► With navigation system

Owners of models equipped with a navigation system should refer to the “Navigation System Owner’s Manual”.

► Without navigation system

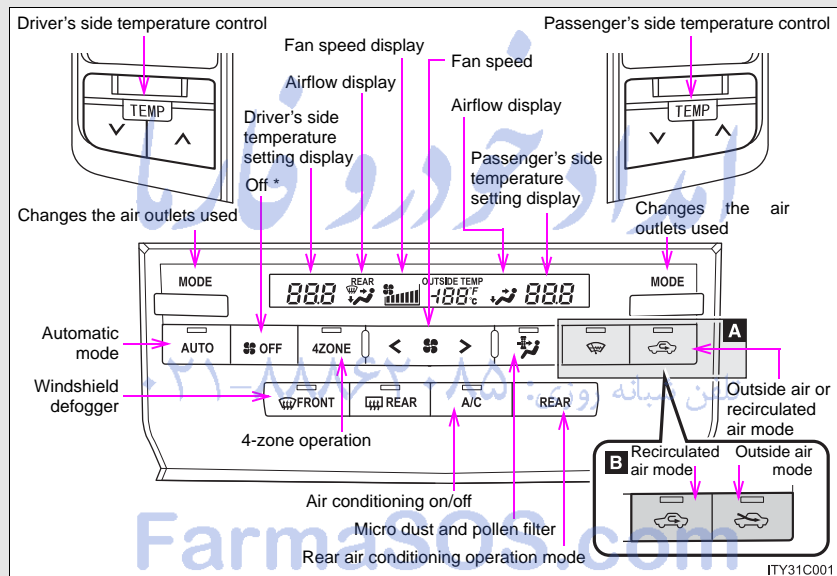

A Vehicles with windshield wiper de-icer

B Vehicles without windshield wiper de-icer

*: The front air conditioning system cannot be switched off while the cool box is on. (→P. 475)

3-1. Using the air conditioning system and defogger

Using the automatic mode

STEP 1 Press  .

The air conditioning system will begin to operate. Air outlets and fan speed are automatically adjusted according to the temperature setting.

STEP 2 Press “^” to increase the temperature and “v” to decrease the

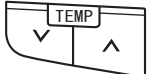
temperature on  .

The temperature for the driver's and front passenger's seats can be set separately.

امداد خودرو فارما

تلفن شبانه روزی: ۰۲۱-۸۸۸۶۲۰۸۵

FarmaSOS.com

Adjusting the settings

■ Adjusting the temperature setting

Press “^” to increase the temperature and “v” to decrease the temperature on

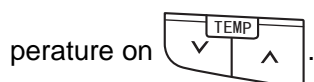

The air conditioning system switches between individual and simultaneous modes each time  is pressed.

Individual mode (the indicator on  is on.): The temperature for the driver's, front passenger's and rear seats (→P. 341) can be set separately. Operating the passenger's side or rear temperature control will enter individual mode.

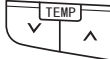
Simultaneous mode (the indicator on  is off.): Only  (driver's side) can be used to adjust the temperature for all seats.

■ Adjusting the fan speed

Press “>” (increase) or “<” (decrease) on .

The fan speed is shown on the display. (7 levels)

Press  to turn the fan off.

3-1. Using the air conditioning system and defogger

■ Changing the air outlets

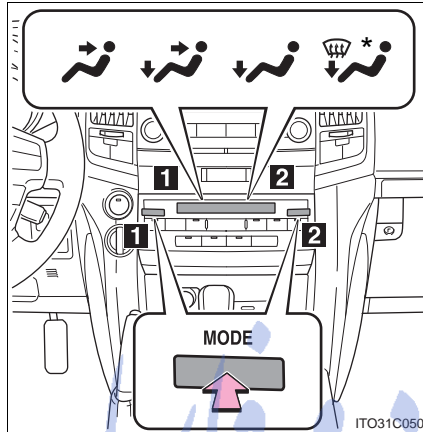

Press .

- 1** For driver's seat
- 2** For front passenger's seat

The air outlets switch each time the button is pressed.

Different air outlets for the driver's and front passenger's seats can be chosen.

*: Driver side only

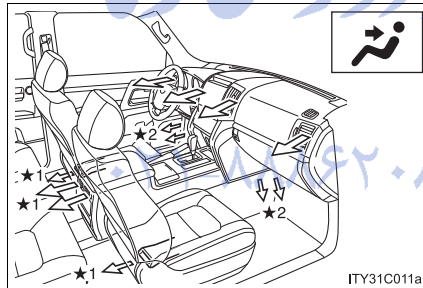

Air flows to the upper body.

*1: Depending on the rear air conditioning setting.

*2: Only in the automatic mode

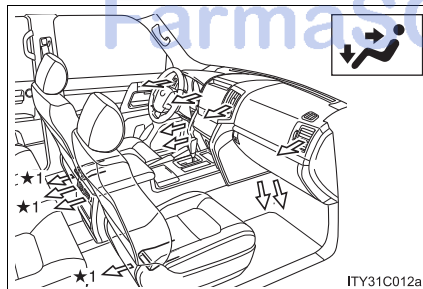

Air flows to the upper body and feet.

*1: Depending on the rear air conditioning setting.

3-1. Using the air conditioning system and defogger

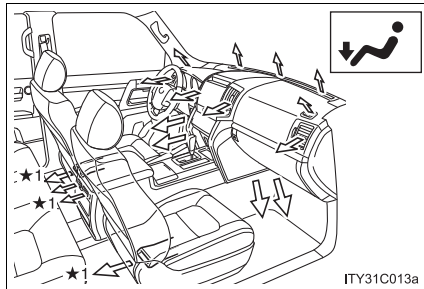

Air flows to the feet.

*1: Depending on the rear air conditioning setting.

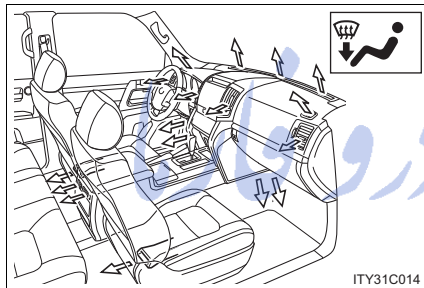

Air flows to the feet and the windshield defogger operates.

■ Switching between outside air and recirculated air modes

- ▶ Vehicles with windshield wiper de-icer تلفن شبانه روزی

Press .

The mode switches between outside air mode (indicator off) and recirculated air mode (indicator on) each time the button is pressed.

- ▶ Vehicles without windshield wiper de-icer

Press  to switch to recirculated air mode and press

 to switch to outside air mode.

Changing the rear seat settings from the front seat

■ Adjusting the temperature setting

STEP 1 Press  .

STEP 2 Press “^” to increase the temperature and “v” to decrease the

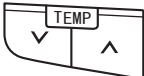
temperature on  (for left-hand rear seat) and

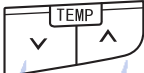
 (for right-hand rear seat).

The temperature for the right-hand and left-hand rear seats can be adjusted separately. Operating the switch will enter individual mode.

The air conditioning system switches between individual and simultaneous modes each time  is pressed.

■ Adjusting the fan speed

STEP 1 Press  .

STEP 2 Press “>” (increase) or “<” (decrease) on  .

The fan speed is shown on the display. (7 levels)

Press  to turn the fan off.

■ Changing the air outlets

STEP 1 Press  .

STEP 2 Press  .

The air outlets switch each time the button is pressed. (→P. 339)

3-1. Using the air conditioning system and defogger

Defogging the windshield

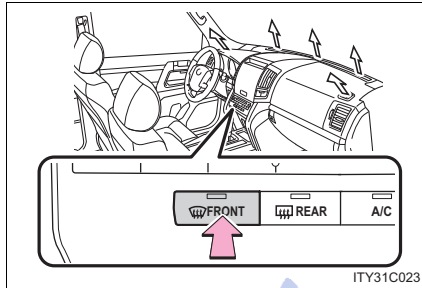

Press .

The air conditioning system control operates automatically.

Recirculated air mode will automatically switch to outside air mode.

Micro dust and pollen filter

Press .

Outside air mode switches to recirculated air mode. Pollen is removed from the air and the air flows to the upper part of the body.

Usually the system will turn off automatically approximately 1 to 3 minutes.

To stop the operation, press  again.

FarmaSOS.com

Adjusting the position and opening and closing the air outlets

► Front center outlets

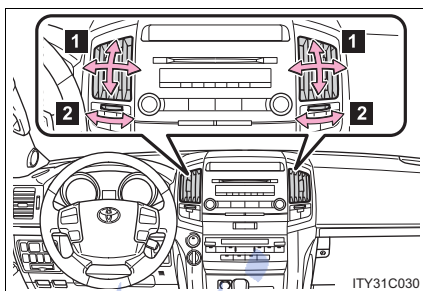

- 1 Direct air flow to the left or right, up or down.
- 2 Turn the knob to open or close the vent.

► Front side outlets

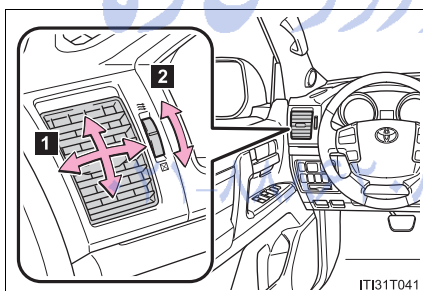

- 1 Direct air flow to the left or right, up or down.
- 2 Turn the knob to open or close the vent.

► Rear center outlets

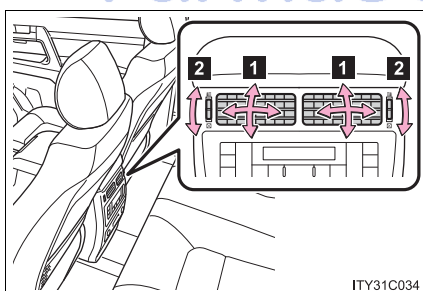

- 1 Direct air flow to the left or right, up or down.
- 2 Turn the knob to open or close the vent.

3-1. Using the air conditioning system and defogger

■ Using the automatic mode

Fan speed is adjusted automatically in accordance with the temperature setting and ambient conditions. As a result, the following may occur.

- Immediately after  is pressed, the fan may stop for a while until warm or cool air is ready to flow.
- Cool air may flow to the area around the upper body when the heater is on.



■ Using the system in recirculated air mode

The windows will fog up more easily if the recirculated air mode is used for an extended period.

■ Switching between outside air and recirculated air modes

Recirculated air mode or outside air mode may be automatically switched in accordance with the temperature setting and the inside temperature.

■ When the outside temperature exceeds 75°F (24°C) and the air conditioning system is on

- In order to reduce the air conditioning power consumption, the air conditioning system may switch to recirculated air mode automatically. This may also reduce fuel consumption.
- Recirculated air mode is selected as a default mode when the “ENGINE START STOP” switch is turned to IGNITION ON mode.
- Vehicles with windshield wiper de-icer: It is possible to switch to outside air mode at any time by pressing .
- Vehicles without windshield wiper de-icer: It is possible to switch to outside air mode at any time by pressing .

■ Window defogger feature

Recirculated air mode may automatically switch to outside air mode in situations where the windows need to be defogged.

3-1. Using the air conditioning system and defogger

■ When outside temperature approaches 32°F (0°C)

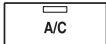
The air conditioning system may not operate even when  is pressed.

■ Micro dust and pollen filter

● In order to prevent the windows from fogging up when the outside air is cold, the following may occur.

- Outside air mode does not switch to recirculated air mode.
- The air conditioning system operates automatically.
- The operation cancels after 1 minute.

● In rainy weather, the windows may fog up. Press .

■ Air conditioning odors

● During use, various odors from inside and outside the vehicle may enter into and accumulate in the air conditioning system. This may then cause odor to be emitted from the vents.

● To reduce potential odors from occurring:

- It is recommended that the air conditioning system be set to outside air mode prior to turning the vehicle off.
- The start timing of the blower may be delayed for a short period of time immediately after the air conditioning system is started in automatic mode.

■ Air conditioning filter

→P. 560

■ Customization that can be configured at Toyota dealer

Settings (e.g. A/C Auto switch operation) can be changed.
(Customizable features →P. 694)

3-1. Using the air conditioning system and defogger

CAUTION

■ To prevent the windshield from fogging up

Do not use  during cool air operation in extremely humid weather. The difference between the temperature of the outside air and that of the windshield can cause the outer surface of the windshield to fog up, blocking your vision.

NOTICE

■ To prevent battery discharge

Do not leave the air conditioning system on longer than necessary when the engine is stopped.

تلفن شبانه روزی: ۰۲۱-۸۸۸۶۲۰۸۵

FarmaSOS.com

3-1. Using the air conditioning system and defogger Rear air conditioning system

Airflow and outlets are automatically adjusted according to the temperature setting.

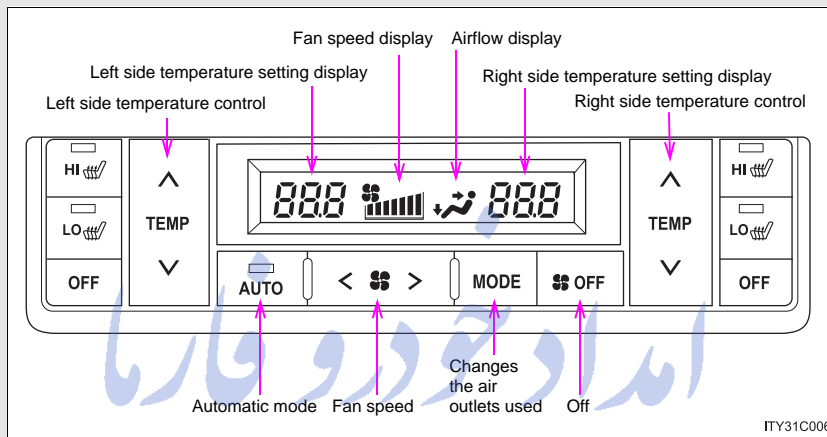

Using the automatic mode

STEP 1 Press .

The air conditioning system will begin to operate. Air outlets and fan speed are automatically adjusted according to the temperature setting.

STEP 2 Press “^” to increase the temperature and “v” to decrease the

temperature on .

The temperature for the right-hand and left-hand rear seats can be set separately.

Adjusting the settings

■ Adjusting the temperature setting

Press “^” to increase the temperature and “v” to decrease the tem-

perature on

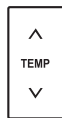

The temperature for the right-hand and left-hand rear seats can be set separately.

■ Adjusting the fan speed

Press “>” (increase) or “<” (decrease) on



The fan speed is shown on the display. (7 levels)

Press



to turn the fan off.

تلفن شبانه روزی: ۰۲۱-۸۸۸۶۲۰۸۵

FarmaSOS.com

3-1. Using the air conditioning system and defogger

■ Changing the air outlets

Press **MODE**.

The air outlets switch each time the button is pressed.

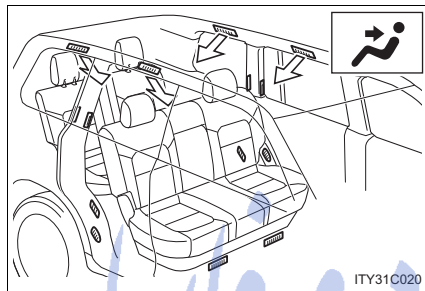

Air flows to the upper body.

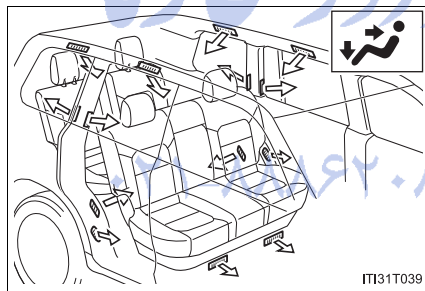

Air flows to the upper body and feet.

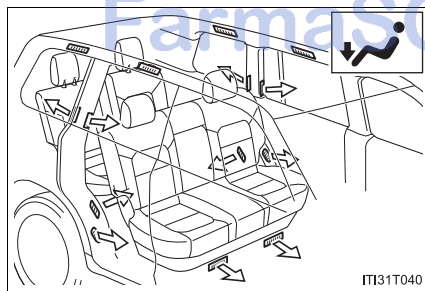

Air flows to the feet.

3-1. Using the air conditioning system and defogger

Adjusting the position and opening and closing the air outlets

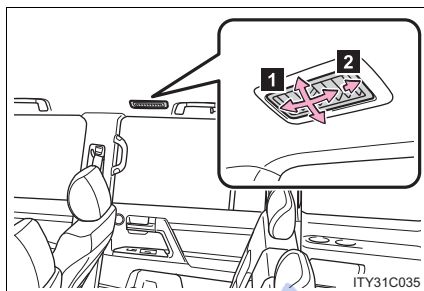

1 Direct air flow to the left or right, up or down.

2 Turn the knob fully to the back of the vehicle to close the vent.

NOTICE

To prevent battery discharge

Do not leave the air conditioning system on longer than necessary when the engine is stopped.

تلفن شبانه روزی: ۰۲۱-۸۸۸۶۲۰۸۵

FarmaSOS.com

3-1. Using the air conditioning system and defogger Rear window and outside rear view mirror defoggers

These features are used to defog the rear window, and to remove raindrops, dew and frost from the outside rear view mirrors.

► With navigation system

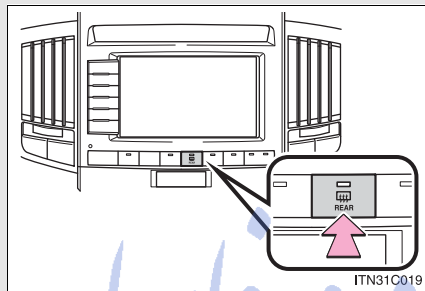

On/off

The operation time changes according to the ambient temperature and vehicle speed. Pressing the switch again also turns the defoggers off.

► Without navigation system

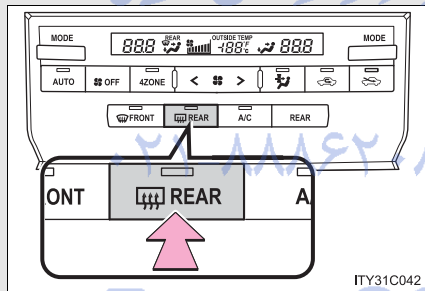

■ The rear window and outside rear view mirror defoggers can be operated when

The "ENGINE START STOP" switch is in IGNITION ON mode.

⚠ CAUTION

■ When the outside rear view mirror defoggers are on

Do not touch the rear view mirror surfaces, as they can become very hot and burn you.

3-1. Using the air conditioning system and defogger Windshield wiper de-icer*

This feature is used to prevent ice from building up on the windshield and wiper blades.

► With navigation system

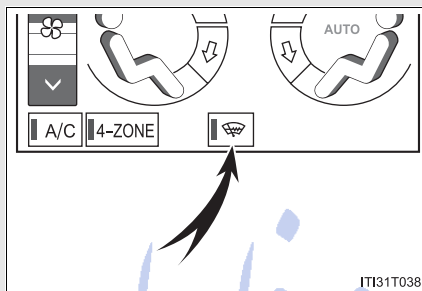

On/off

The windshield wiper de-icer will automatically turn off after approximately 15 minutes. Pressing the switch again also turns the de-icer off.

► Without navigation system

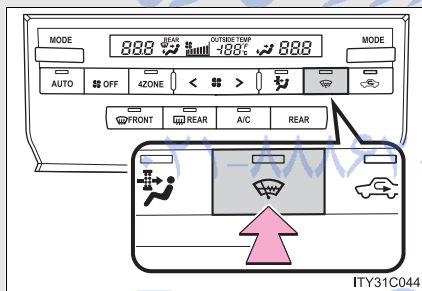

■ The windshield wiper de-icer can be operated when

The "ENGINE START STOP" switch is in IGNITION ON mode.

⚠ CAUTION

■ When the windshield wiper de-icer is on

Do not touch the glass at the lower part of the windshield or the side of the front pillars as the surfaces can become very hot and burn you.

*: If equipped

3-2. Using the audio system

Audio system type

- ▶ With navigation system
Owners of models equipped with a navigation system should refer to the “Navigation System Owner’s Manual”.
- ▶ Without navigation system
CD player with changer and AM/FM radio.
- Type A

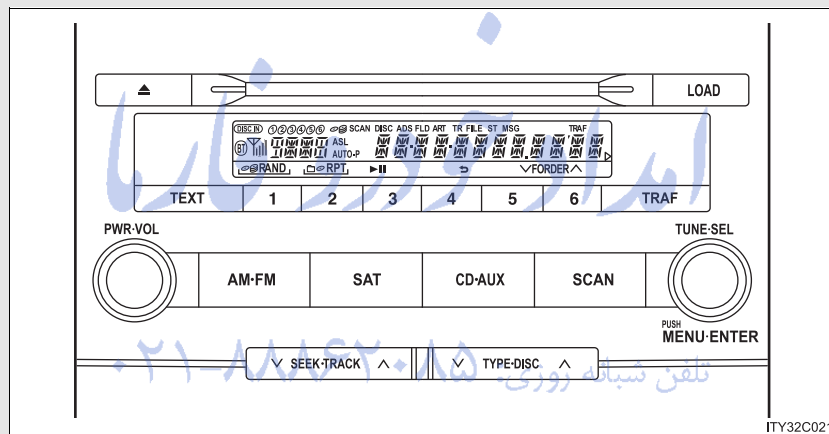

3

Interior features

FarmaSOS.com

3-2. Using the audio system

● Type B

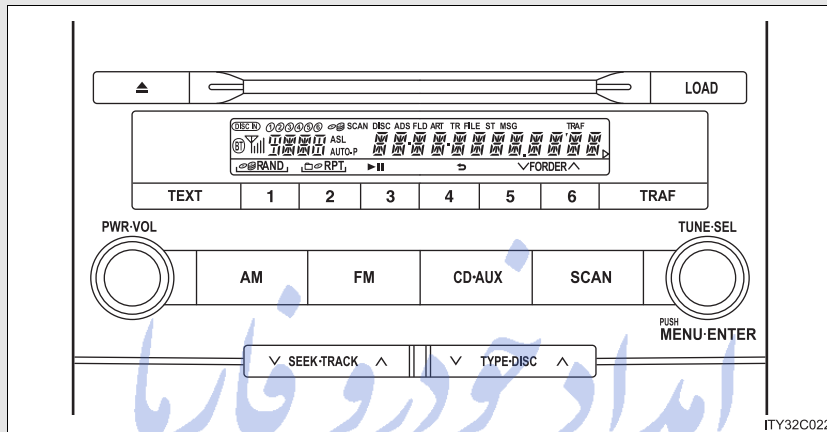

Title	Page
Using the radio	P. 356
Using the CD player	P. 365
Playing back MP3 and WMA discs	P. 373
Operating an iPod	P. 380
Operating a USB memory	P. 387
Optimal use of the audio system	P. 395
Using the AUX port	P. 397
Using the steering switches	P. 398

■ Using cellular phones

Interference may be heard through the audio system's speakers if a cellular phone is being used inside or close to the vehicle while the audio system is operating.

CAUTION

■ For vehicles sold in the U.S.A.

● Part 15 of the FCC Rules

FCC Warning:

Any unauthorized changes or modifications to this equipment will void the user's authority to operate this device.

● Laser products

- Do not take this unit apart or attempt to make any changes yourself. This is an intricate unit that uses a laser pickup to retrieve information from the surface of compact discs. The laser is carefully shielded so that its rays remain inside the cabinet. Therefore, never try to disassemble the player or alter any of its parts since you may be exposed to laser rays and dangerous voltages.
- This product utilizes a laser. Use of controls or adjustments or performance of procedures other than those specified herein may result in hazardous radiation exposure.

NOTICE

■ To prevent battery discharge

Do not leave the audio system on longer than necessary with the engine off.

■ To avoid damaging the audio system

Take care not to spill drinks or other fluids over the audio system.

3-2. Using the audio system Using the radio

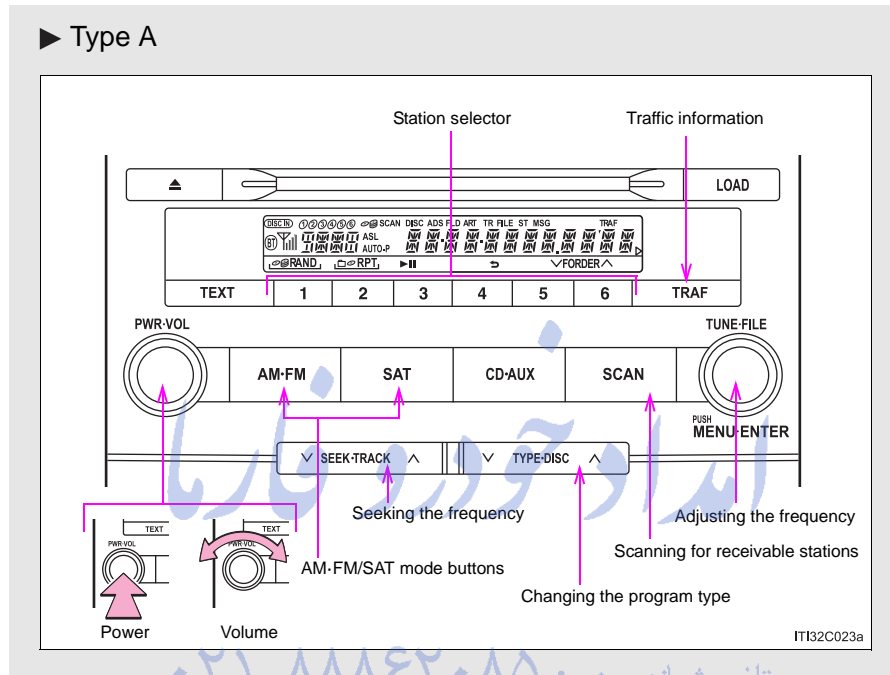

تلفن شبانه روزی: ۰۲۱-۸۸۸۶۲۰۸۵

FarmaSOS.com

3-2. Using the audio system

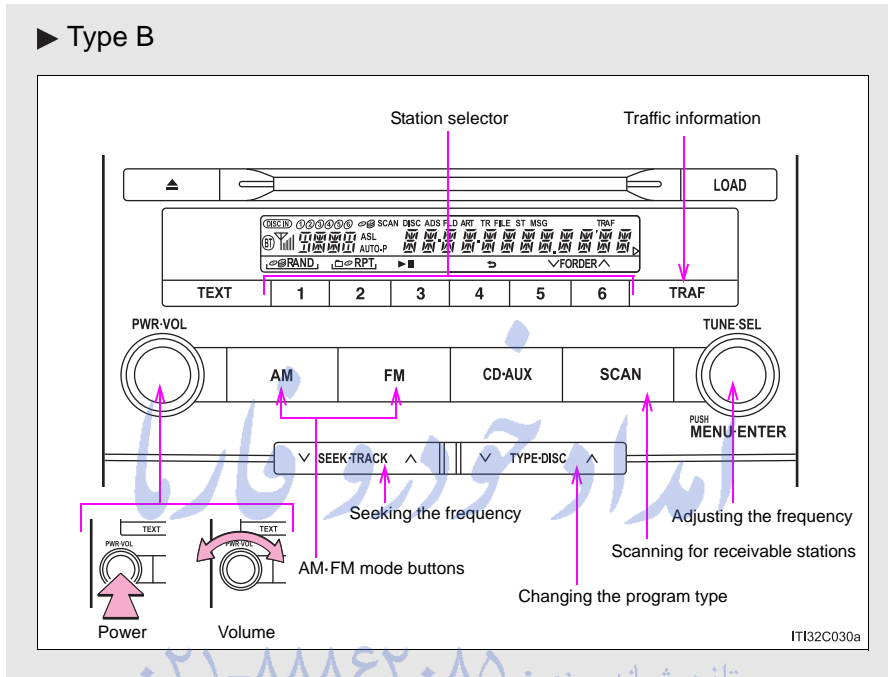





3

Interior features



FarmaSOS.com

Setting station presets (excluding XM[®] Satellite Radio)



- STEP 1** Search for desired stations by turning  or pressing “^” or “v” on .
- STEP 2** Press and hold the button (from  to ) the station is to be set to, and you hear a beep.

Scanning radio stations (excluding XM[®] Satellite Radio)

■ Scanning the preset radio stations

- STEP 1** Press and hold  until you hear a beep.
Preset stations will be played for a few seconds each.
- STEP 2** When the desired station is reached, press  once again.

■ Scanning all radio stations within range



- STEP 1** Press .
“SCAN” appears on the display and all stations with reception will be played for a few seconds each.
- STEP 2** When the desired station is reached, press  once again.



XM[®] Satellite Radio (type A)**■ Receiving XM[®] Satellite Radio****STEP 1** Press .

The display changes as follows each time the button is pressed.

"SAT1" → "SAT2" → "SAT3"



STEP 2 Turn  to select a desired channel from all the categories or press "∧" or "∨" on  to select a desired channel in the current category.

■ Presetting XM[®] Satellite Radio channelsSelect the desired channel. Press and hold the button (from  to ) until you hear a beep.**■ Changing the channel category**Press "∧" or "∨" on .**■ Scanning XM[®] Satellite Radio channels**

- Scanning channels in the current category

STEP 1 Press .**STEP 2** When the desired channel is reached, press the button again.

- Scanning preset channels

STEP 1 Press and hold  until you hear a beep.**STEP 2** When the desired channel is reached, press the button again.

RDS (Radio Data System)

This feature allows your radio to receive station identification information and program information (classical, jazz, etc.) from radio stations which broadcast this information.

■ Receiving RDS broadcasts

STEP 1 Press “^” or “v” on the during FM reception. The type of program changes each time the button is pressed.

- ROCK
- EASYLIS (Easy listening)
- CLS/JAZZ (Classical music and Jazz)
- R & B (Rhythm and Blues)
- INFORM (Information)
- RELIGION
- MISC (Miscellaneous)
- ALERT (Emergency messages)

STEP 2 Press , or “^” or “v” on .

The radio seeks scans the station by the relevant program type.

If no radio station of that type is found, “NOTHING” appears on the display.

■ Displaying radio station names

Press .

■ **Displaying radio text messages**

Press .

If MSG is shown on the display, a text message will be displayed.

If the text continues past the end of the display, ► is displayed. Press and hold until you hear a beep.

■ **Traffic announcement**

Press .

“TRAF SEEK” appears on the display, and the radio will start seeking any station broadcasting traffic program information.

If no traffic program station is found, “NO TRAF INFO” appears on the display.

■ **When the battery is disconnected**

All preset stations are erased.

■ **Reception sensitivity**

- Maintaining perfect radio reception at all times is difficult due to the continually changing position of the antenna, differences in signal strength and surrounding objects, such as trains, transmitters, etc.
- The radio antenna is mounted inside the rear quarter window. To maintain clear radio reception, do not attach metallic window tinting or other metallic objects to the antenna wire mounted inside the rear quarter window.

3-2. Using the audio system

■ Receiving XM® Satellite Radio

An XM® Satellite Radio is a tuner designed exclusively to receive broadcasts provided under a separate subscription. Availability is limited to the 48 contiguous states and some Canadian provinces.

- XM® subscriptions

For detailed information about XM® Satellite Radio or to subscribe: Visit on the web at www.xmradio.com or call 1-800-967-2346.

- Radio ID

You will need the radio ID when activating XM® service or reporting a problem. Select "CH000" using  , and the receiver's 8-character ID number will appear.

- Satellite tuner

The tuner supports only Audio Services (Music and Talk) and the accompanying Text Information of XM® Satellite Radio.

تلفن شبانه روزی: ۰۲۱-۸۸۸۶۲۰۸۵

FarmaSOS.com

■ **If the satellite radio does not operate normally**

If a problem occurs with the XM[®] tuner, a message will appear on the display. Refer to the table below to identify the problem, and take the suggested corrective action.

ANTENNA	The XM [®] antenna is not connected. Check whether the XM [®] antenna cable is attached securely.
	There is a short-circuit in the antenna or the surrounding antenna cable. See a Toyota certified dealer.
UNAUTH	You have not subscribed to XM [®] Satellite Radio. The radio is being updated with the latest encryption code. Contact XM [®] Satellite Radio for subscription information. When a contract is canceled, you can choose "CH000" and all free-to-air channels.
	The premium channel you selected is not authorized. Wait for about 2 seconds until the radio returns to the previous channel or "CH001". If it does not change automatically, select another channel. If you want to listen to the premium channel, contact XM [®] Satellite Radio.
NO SIGNAL	The XM [®] signal is too weak at the current location. Wait until your vehicle reaches a location with a stronger signal.
LOADING	The unit is acquiring audio or program information. Wait until the unit has received the information.
OFF AIR	The channel you selected is not broadcasting any programming. Select another channel.

3-2. Using the audio system

-----	There is no song/program title or artist name/feature associated with the channel at that time. No action needed.
CH UNAVL	The channel you selected is no longer available. Wait for about 2 seconds until the radio returns to the previous channel or "CH001". If it does not change automatically, select another channel.

Contact the XM® Listener Care Center at 1-800-967-2346.

■ Certifications for the radio tuner

This equipment has been tested and found to comply with the limits for a class B digital device, pursuant to Part 15 of the FCC Rules. These limits are designed to provide reasonable protection against harmful interference in a residential installation. This equipment generates, uses and can radiate radio frequency energy and, if not installed and used in accordance with the instructions, may cause harmful interference to radio communications. However, there is no guarantee that interference will not occur in a particular installation.

If this equipment does cause harmful interference to radio or television reception, which can be determined by turning the equipment off and on, the user is encouraged to try to correct the interference by trying one or more of the following:

- Reorienting or relocating the receiving antenna.
- Increasing the separation between the equipment and receiver.
- Connecting the equipment into an outlet on a circuit different from that to which the receiver is connected.
- Consulting the dealer or an experienced radio/TV technician for help.

3-2. Using the audio system Using the CD player

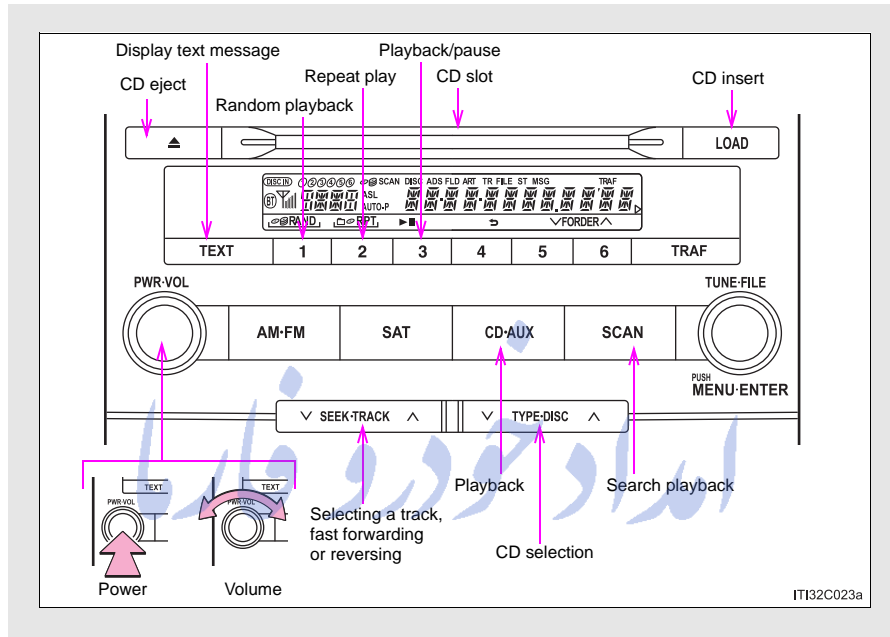

3

Interior features

Loading a CDs

■ Loading a single CD

STEP 1 Press **LOAD**.

"WAIT" appears on the display.

STEP 2 Insert a CD when the indicator on the slot turns from amber to green.

The display changes from "WAIT" to "LOAD".

3-2. Using the audio system

■ Loading multiple CDs

STEP 1 Press and hold until you hear a beep.

“WAIT” appears on the display.

STEP 2 Insert a CD when the indicator on the slot turns from amber to green.

The display changes from “WAIT” to “LOAD”.

The indicator on the slot turns to amber when the CD is inserted.

STEP 3 Insert the next CD when the indicator on the slot turns from amber to green again.

Repeat the procedure for the remaining CDs.

To cancel the operation, press or . If you do not insert a CD within 15 seconds, loading will be canceled automatically.

Ejecting CDs

■ Ejecting a CD

STEP 1 To select the CD to be ejected, press “^” or “v” on

.

The number of the CD selected is shown on the display.

STEP 2 Press and remove the CD.

■ Ejecting all CDs

Press and hold until you hear a beep, then remove the CDs.

Selecting a CD**■ To select a CD to play**

Press “^” or “v” on until the desired CD number appears on the display.

■ To scan loaded CDs

STEP 1 Press and hold until you hear a beep.

The first 10 seconds of the first track on each CD will be played.

STEP 2 Press once again when the desired CD is reached.

Selecting a track

Press “^” to move up or “v” to move down using until the desired track number appears on the display.

Playing and pausing tracks

To play or pause a track, press (▶||).

Fast forwarding and rewinding tracks

Press and hold “^” or “v” on .

Scanning a CD

STEP 1 Press .

“SCAN” appears on the display.

The first 10 seconds of each track will be played.

STEP 2 Press once again when the desired track is reached.

3-2. Using the audio system

Random playback

■ Current CD

Press (RAND).

Tracks are played in random order until the button is pressed once again.

■ All CDs

Press and hold (RAND) until you hear a beep.

Tracks on all loaded CDs are played in random order until the button is pressed once again.

Repeating a track or a disc

■ Repeating a track

Press (RPT).

■ Repeating a disc

Press and hold (RPT) until you hear a beep.

Switching the display

Press .

Each time the button is pressed, the display changes in the order of Track no./Elapsed time → CD title → Track name.

■ Display

Up to 12 characters can be displayed at a time.

If there are 13 characters or more, pressing and holding for 1 second or more will display the remaining characters.

A maximum of 24 characters can be displayed.

If is pressed for 1 second or more again or has not been pressed for 6 seconds or more, the display will return to the first 12 characters.

Depending on the contents recorded, the characters may not be displayed properly or may not be displayed at all.

■ Canceling random, repeat and scan playback

Press (RAND), (RPT) or again.

■ Error messages

“ERROR”: This indicates a trouble either in the CD or inside the player. The CD may be dirty, damaged or inserted up-side down.

تلفن شبانه روزی: ۰۲۱-۸۸۶۲۰۸۵

FarmaSOS.com

3-2. Using the audio system

■ Discs that can be used

Discs with the marks shown below can be used.
Playback may not be possible depending on recording format or disc features, or due to scratches, dirt or deterioration.



CDs with copy-protect features may not play correctly.

■ CD player protection feature

To protect the internal components, playback is automatically stopped when a problem is detected.

■ If CDs are left inside the CD player or in the ejected position for extended periods

CDs may be damaged and may not play properly.

■ Lens cleaners

Do not use lens cleaners. Doing so may damage the CD player.

تلفن شبانه روزی: ۰۲۱-۸۸۸۶۲۰۸۵

FarmaSOS.com

⚠ NOTICE

■ CDs and adapters that cannot be used

Do not use the following types of CDs.
 Also, do not use 3 in. (8 cm) CD adapters, DualDiscs or printable discs.
 Doing so may damage the player and/or the CD insert/eject function.

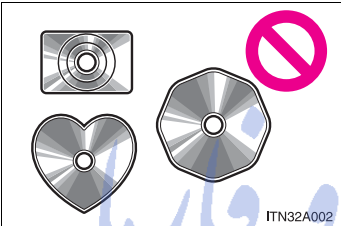

ITN32A002

- CDs that have a diameter that is not 4.7 in. (12 cm).

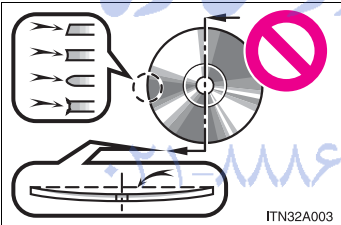

ITN32A003

- Low-quality and deformed CDs.

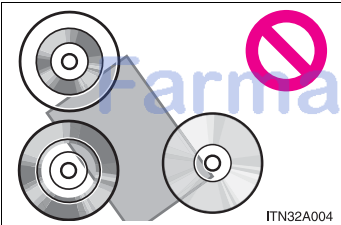

ITN32A004

- CDs with a transparent or translucent recording area.

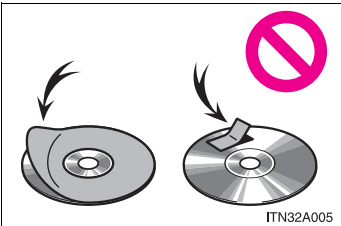

ITN32A005

- CDs that have tape, stickers or CD-R labels attached to them, or that have the label peeled off.

3-2. Using the audio system

NOTICE

■ Player precautions

Failure to follow the precautions below may result in damage to the CDs or the player itself.

- Do not insert anything other than CDs into the CD slot.
- Do not apply oil to the player.
- Store CDs away from direct sunlight.
- Never try to disassemble any part of the player.

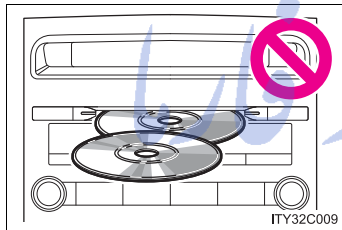

- Do not insert more than one CD at a time.

تلفن شبانه روزی: ۰۲۱-۸۸۶۲۰۸۵

FarmaSOS.com

3-2. Using the audio system Playing back MP3 and WMA discs

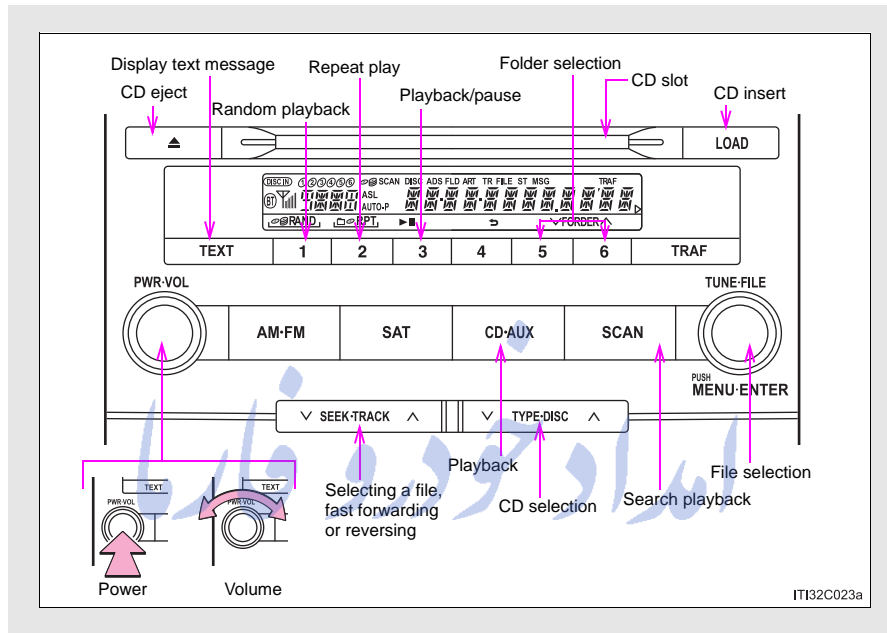

Loading and ejecting MP3 and WMA discs

→P. 365

Selecting a CD

→P. 365

Playing and pausing files

To play or pause a file, press **3** (▶||).

3-2. Using the audio system

Selecting and scanning a folder

■ Selecting folders one at a time

Press (∨) or (∧) to select the desired folder.

To return to the first folder, press and hold (∨) until you hear a beep.

■ Selecting the desired folder by cueing the first file of each folder

Press and hold until you hear a beep.

When the desired folder is reached, press the switch once again.

Selecting and scanning a file

■ Selecting one file at a time

Turn the  dial or press “∧” or “∨” on to select the desired file.

■ Selecting the desired file by cueing the files in the folder

Press .

When the desired file is reached, press once again.

Fast forwarding and reversing files

Press and hold “∧” or “∨” on .

Random playback

- **To play files from a particular folder in random order**

Press (RAND).

- **To play all of the files on a disc in random order**

Press and hold (RAND) until you hear a beep.

Repeating a file or a folder

- **Repeating a file**

Press (RPT).

- **Repeating a folder**

Press and hold (RPT) until you hear a beep.

Switching the display

Press .

Each time the switch is pressed, the display changes in the order of Folder no./File no./Elapsed time→Folder name→File name→Album title (MP3 only)→Track title→Artist name.

FarmaSOS.com

■ **Display**

→P. 369

■ **Canceling random, repeat and scan playback**

Press (RAND), (RPT) or again.

■ **Error messages**

“ERROR”: This indicates a trouble either in the CD or inside the player. The CD may be dirty, damaged or inserted up-side down.

“NO MUSIC”: This indicates that the MP3/WMA file is not included in the CD.

■ **Discs that can be used**

Discs with the marks shown below can be used. Playback may not be possible depending on recording format or disc features, or due to scratches, dirt or deterioration.



■ **CD player protection feature**

To protect the internal components, playback is automatically stopped when a problem is detected.

■ **If CDs are left inside the CD player or in the ejected position for extended periods**

CDs may be damaged and may not play properly.

■ Lens cleaners

Do not use lens cleaners. Doing so may damage the CD player.

■ MP3 and WMA files

MP3 (MPEG Audio LAYER3) is a standard audio compression format.

Files can be compressed to approximately 1/10 of their original size by using MP3 compression.

WMA (Windows Media Audio) is a Microsoft audio compression format.

This format compresses audio data to a size smaller than that of the MP3 format.

There is a limit to the MP3 and WMA file standards and to the media/formats recorded by them that can be used.

- MP3 file compatibility
 - Compatible standards
MP3 (MPEG1 LAYER3, MPEG2 LSF LAYER3)
 - Compatible sampling frequencies
MPEG1 LAYER3: 32, 44.1, 48 (kHz)
MPEG2 LSF LAYER3: 16, 22.05, 24 (kHz)
 - Compatible bit rates
MPEG1 LAYER3: 64, 80, 96, 112, 128, 160, 192, 224, 256, 320 (kbps)
MPEG2 LSF LAYER3: 64, 80, 96, 112, 128, 144, 160 (kbps)
* Compatible with VBR
 - Compatible channel modes: stereo, joint stereo, dual channel and monaural
- WMA file compatibility
 - Compatible standards
WMA Ver. 7, 8, 9
 - Compatible sampling frequencies
32, 44.1, 48 (kHz)
 - Compatible bit rates
Ver. 7, 8: CBR 48, 64, 80, 96, 128, 160, 192 (kbps)
Ver. 9: CBR 48, 64, 80, 96, 128, 160, 192, 256, 320 (kbps)
* Only compatible with 2-channel playback

3-2. Using the audio system

● Compatible media

Media that can be used for MP3 and WMA playback are CD-Rs and CD-RWs.

Playback in some instances may not be possible, depending on the status of the CD-R or CD-RW. Playback may not be possible or the audio may jump if the disc is scratched or marked with fingerprints.

● Compatible disc formats

The following disc formats can be used.

- Disc formats: CD-ROM Mode 1 and Mode 2
CD-ROM XA Mode 2, Form 1 and Form 2
- File formats: ISO9660 Level 1, Level 2, (Romeo, Joliet)
MP3 and WMA files written in any format other than those listed above may not play correctly, and their file names and folder names may not be displayed correctly.

Items related to standards and limitations are as follows.

- Maximum directory hierarchy: 8 levels
- Maximum length of folder names/file names: 32 characters
- Maximum number of folders: 192 (including the root)
- Maximum number of files per disc: 255

● File names

The only files that can be recognized as MP3/WMA and played are those with the extension .mp3 or .wma.

● Multi-sessions

As the audio system is compatible with multi-sessions, it is possible to play discs that contain MP3 and WMA files. However, only the first session can be played.

● ID3 and WMA tags

ID3 tags can be added to MP3 files, making it possible to record the track title and artist name, etc.

The system is compatible with ID3 Ver. 1.0, 1.1, and Ver. 2.2, 2.3 ID3 tags. (The number of characters is based on ID3 Ver. 1.0 and 1.1.)

WMA tags can be added to WMA files, making it possible to record the track title and artist name in the same way as with ID3 tags.

- MP3 and WMA playback

When a disc containing MP3 or WMA files is inserted, all files on the disc are first checked. Once the file check is finished, the first MP3 or WMA file is played. To make the file check finish more quickly, we recommend you do not write in any files other than MP3 or WMA files or create any unnecessary folders.

If the discs contain a mixture of music data and MP3 or WMA format data, only music data can be played.

- Extensions

If the file extensions .mp3 and .wma are used for files other than MP3 and WMA files, they will be mistakenly recognized and played as MP3 and WMA files. This may result in large amounts of interference and damage to the speakers.

- Playback

- To play MP3 file with steady sound quality, we recommend a fixed bit rate of 128 kbps and a sampling frequency of 44.1 kHz.
- CD-R or CD-RW playback may not be possible in some instances, depending on the characteristics of the disc.
- There is a wide variety of freeware and other encoding software for MP3 and WMA files on the market, and depending on the status of the encoding and the file format, poor sound quality or noise at the start of playback may result. In some cases, playback may not be possible at all.
- When files other than MP3 or WMA files are recorded on a disc, it may take more time to recognize the disc and in some cases, playback may not be possible at all.
- Microsoft, Windows, and Windows Media are the registered trademarks of Microsoft Corporation in the U.S. and other countries.



NOTICE

- **CDs and adapters that cannot be used (→P. 371)**
- **Player precautions (→P. 372)**

3-2. Using the audio system Operating an iPod

Connecting an iPod enables you to enjoy music from the vehicle speakers.

■ Connecting an iPod

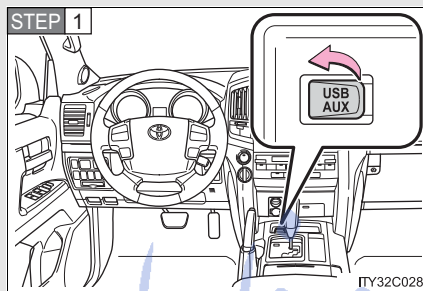

Open the cover and connect an iPod using an iPod cable.

Turn on the power of the iPod if it is not turned on.

STEP 2 Press  .

■ Control panel

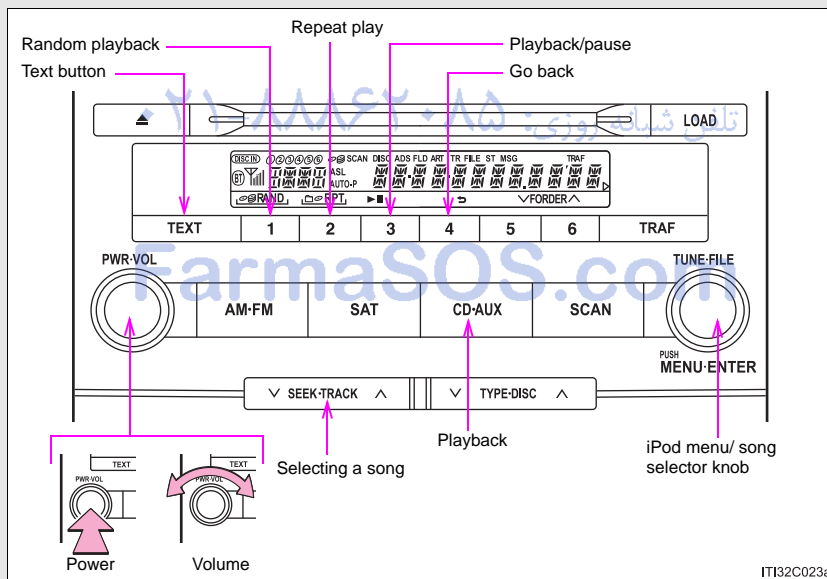

Selecting a play mode

STEP 1 Press  to select iPod menu mode.

STEP 2 Turning  changes the play mode in the following order:
“PLAYLISTS”→“ARTISTS”→“ALBUMS”→“SONGS”→
“PODCASTS”→“GENRES”→“COMPOSERS”→
“AUDIOBOOKS”

STEP 3 Press  to select the desired play mode.

تلفن شبانه روزی: ۰۲۱-۸۸۶۲۰۸۵

FarmaSOS.com

3-2. Using the audio system

■ Play mode list

Play mode	First selection	Second selection	Third selection	Fourth selection
"PLAYLISTS"	Playlists select	Songs select	-	-
"ARTISTS"	Artists select	Albums select	Songs select	-
"ALBUMS"	Albums select	Songs select	-	-
"SONGS"	Songs select	-	-	-
"PODCASTS"	Albums select	Songs select	Albums select	Songs select
"GENRES"	Genre select	Artists select	Songs select	-
"COMPOSERS"	Composers select	Albums select	-	-
"AUDIOBOOKS"	Songs select	-	-	-

■ Selecting a list

STEP 1 Turn  to display the first selection list.

STEP 2 Press  to select the desired item.



Pressing the knob changes to the second selection list.

STEP 3 Repeat the same procedure to select the desired song name.

To return to the previous selection list, select "GO BACK" or press

4 (.

Selecting songs

Turn  or press “^” or “v” on  to select the desired song.

Playing and pausing songs

To play or pause a song, press  (▶||).

Fast-forwarding and rewinding songs

To fast-forward or rewind, press and hold “^” or “v” on  until you hear a beep.

Shuffle playback

- **Playing songs from one playlist or album in random order**

Press  (RAND).

To cancel, press  (RAND) again.

- **Playing songs from all the playlists or albums in random order**

Press and hold  (RAND) until you hear a beep.

To cancel, press  (RAND) again.

Repeat play

Press  (RPT).

To cancel, press  (RPT) again.

3-2. Using the audio system

Switching the display

Press .

Each time the button is pressed, the display changes in the following order: Elapsed time → Album title → Track title → Artist name

Adjusting sound quality and volume balance

STEP 1 Press  to enter iPod menu mode.

STEP 2 Pressing  changes sound modes. (→P. 395)

■ About iPod

- Apple is not responsible for the operation of this device or its compliance with safety and regulatory standards.
- iPod is a trademark of Apple Inc., registered in the U.S. and other countries.

■ iPod functions

- When an iPod is connected and the audio source is changed to iPod mode, the iPod will resume play from the same point in which it was last used.
- Depending on the iPod that is connected to the system, certain functions may not be available. Disconnecting the device and reconnecting it once again may resolve some malfunctions.

■ iPod problems

To resolve most problems encountered when using your iPod, disconnect your iPod from the vehicle iPod connection and reset it.

For instructions on how to reset your iPod, refer to your iPod Owner's Manual.

■ Display

→P. 369

■ Error messages

“ERROR”: This indicates a problem in the iPod or its connection.

“NO MUSIC”: This indicates that there is no music data in the iPod.

“EMPTY”: This indicates that an empty playlist is selected.

“UPDATE”: This indicates that the version of the iPod is not compatible. Upgrade your iPod software to the latest version.

■ Compatible models

Model	Generation	Software version
iPod	5th generation	Ver. 1.2.0 or higher
iPod nano	1st generation	Ver. 1.3.0 or higher
	2nd generation	Ver. 1.1.2 or higher
	3rd generation	Ver. 1.0.0 or higher
iPod touch	1st generation	Ver. 1.1.0 or higher
iPod classic	1st generation	Ver. 1.0.0 or higher

Depending on differences between models or software version etc., some models listed above might be incompatible with this system.

iPod 4th generation and earlier models are not compatible with this system.

iPhone, iPod mini, iPod shuffle and iPod photo are not compatible with this system.

Items related to standards and limitations are as follows:

- Maximum number of lists in device: 9999
- Maximum number of songs in device: 65535
- Maximum number of songs per list: 65535

3-2. Using the audio system

CAUTION

■ While driving

Do not connect iPod or operate the controls.

NOTICE

■ To prevent damage to iPod

- Do not leave iPod in the vehicle. The temperature inside the vehicle may become high, resulting in damage to the player.
- Do not push down on or apply unnecessary pressure to the iPod while it is connected as this may damage the iPod or its terminal.
- Do not insert foreign objects into the port as this may damage the iPod or its terminal.

تلفن شبانه روزی: ۰۲۱-۸۸۶۲۰۸۵

FarmaSOS.com

3-2. Using the audio system Operating a USB memory

Connecting a USB memory enables you to enjoy music from the vehicle speakers.

■ Connecting a USB memory

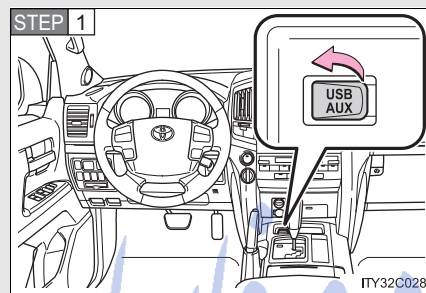

Open the cover and connect a USB memory.

Turn on the power of the USB memory if it is not turned on.

STEP 2 Press **CD-AUX**.

■ Control panel

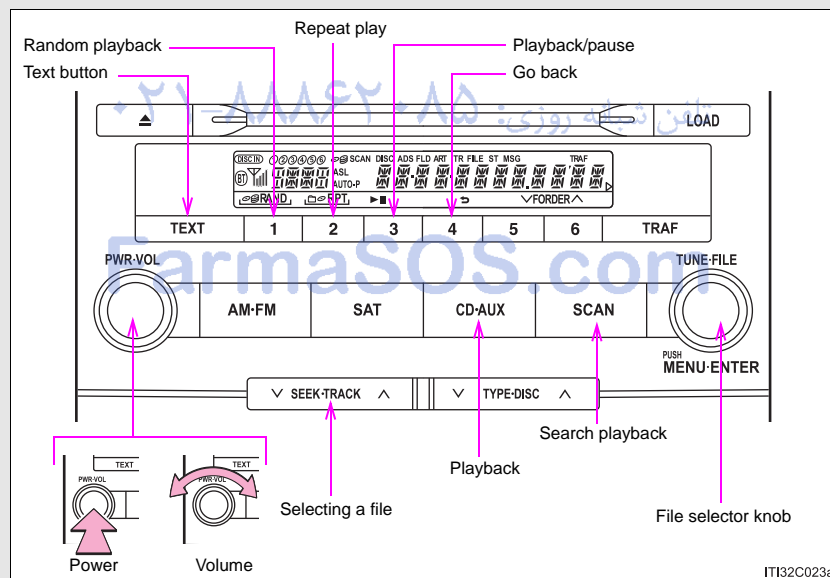

3-2. Using the audio system

Selecting and scanning a folder

■ Selecting folders one at a time

Press (^) or (v) to select the desired folder.

■ Returning to the first folder

Press and hold (v) until you hear a beep.

■ Scanning the first file of all the folders

STEP 1 Press and hold until you hear a beep.

The first ten seconds of the first file in each folder will be played.

STEP 2 When the desired folder is reached, press again.

Selecting and scanning files

■ Selecting a file

Turn  or press “^” or “v” on to select the desired file.

■ Scanning the files in a folder

Press .

The first ten seconds of each file will be played.

To cancel, press again.

When the desired file is reached, press again.

Playing and pausing files

To play or pause a file, press (▶||).

Fast-forwarding and rewinding files

To fast-forward or rewind, press and hold “^” or “v” on

∇ SEEK·TRACK ▲

until you hear a beep.

Random playback

■ Playing files from a folder in random order

Press (RAND).

To cancel, press (RAND) again.

■ Playing all the files from a USB memory in random order

Press and hold (RAND) until you hear a beep.

To cancel, press (RAND) again.

Repeat play

■ Repeating a file

Press (RPT).

To cancel, press (RPT) again.

■ Repeating all the files in a folder

Press and hold (RPT) until you hear a beep.

To cancel, press (RPT) again.

3-2. Using the audio system

Switching the display

Press .

Each time the button is pressed, the display changes in the following order: Elapsed time → Folder name → File name → Album title → Track title → Artist name

■ When using the USB port

You may be unable to use the instrument panel power outlet if a device is connected to the USB port at the same time.

■ USB memory functions

Depending on the USB memory that is connected to the system, certain functions may not be available. Disconnecting the device and reconnecting it once again may resolve some malfunctions.

■ Display

→P. 369

■ Error messages

“ERROR”: This indicates a problem in the USB memory or its connection.

“NO MUSIC”: This indicates that no MP3/WMA files are included in the USB memory.

FarmaSOS.com

■ USB memory

● Compatible devices

USB memory that can be used for MP3 and WMA playback

● Compatible device formats

The following device formats can be used:

- USB communication formats: USB2.0 FS (12mbps)
- File formats: FAT16/32 (Windows)
- Correspondence class: Mass storage class

MP3 and WMA files written in any format other than those listed above may not play correctly, and their file names and folder names may not be displayed correctly.

Items related to standards and limitations are as follows:

- Maximum directory hierarchy: 8 levels
- Maximum number of folders in a device: 999 (including the root)
- Maximum number of files in a device: 65025
- Maximum number of files per folder: 255

● MP3 and WMA files

MP3 (MPEG Audio LAYER 3) is a standard audio compression format.

Files can be compressed to approximately 1/10 of their original size using MP3 compression.

WMA (Windows Media Audio) is a Microsoft audio compression format.

This format compresses audio data to a size smaller than that of the MP3 format.

There is a limit to the MP3 and WMA file standards that can be used and to the media/formats on which the files are recorded.

3-2. Using the audio system

- MP3 file compatibility
 - Compatible standards
MP3 (MPEG1 AUDIO LAYERII, III, MPEG2 AUDIO LAYERII, III, MPEG2.5)
 - Compatible sampling frequencies
MPEG1 AUDIO LAYERII, III: 32, 44.1, 48 (kHz)
MPEG2 AUDIO LAYERII, III: 16, 22.05, 24 (kHz)
MPEG2.5: 8, 11.025, 12 (kHz)
 - Compatible bit rates (compatible with VBR)
MPEG1 AUDIO LAYERII, III: 32-320 (kbps)
MPEG2 AUDIO LAYERII, III: 32-160 (kbps)
MPEG2.5: 32-160 (kbps)
 - Compatible channel modes: stereo, joint stereo, dual channel and monaural
- WMA file compatibility
 - Compatible standards
WMA Ver. 9
 - Compatible sampling frequencies
HIGH PROFILE 32, 44.1, 48 (kHz)
 - Compatible bit rates
HIGH PROFILE 32-320 (kbps, VBR)
- File names

The only files that can be recognized as MP3/WMA and played are those with the extension .mp3 or .wma.
- ID3 and WMA tags

ID3 tags can be added to MP3 files, making it possible to record the track title, artist name, etc.

The system is compatible with ID3 Ver. 1.0, 1.1, and Ver. 2.2, 2.3, 2.4 ID3 tags. (The number of characters is based on ID3 Ver. 1.0 and 1.1.)

WMA tags can be added to WMA files, making it possible to record the track title and artist name in the same way as with ID3 tags.

- MP3 and WMA playback

- When a device containing MP3 or WMA files is connected, all files in the USB memory device are checked. Once the file check is finished, the first MP3 or WMA file is played. To make the file check finish more quickly, we recommend that you do not include any files other than MP3 or WMA files or create any unnecessary folders.
- When the USB device is connected and the audio source is changed to USB memory mode, the USB device will start playing the first file in the first folder. If the same device is removed and reinserted (and the contents have not been changed), the USB device will resume play from the same point in which it was last used.

- Extensions

If the file extensions .mp3 and .wma are used for files other than MP3 and WMA files, they will be mistakenly recognized and played as MP3 and WMA files. This may result in large amounts of interference and damage to the speakers.

- Playback

- To play MP3 files with steady sound quality, we recommend a fixed bit rate of at least 128 kbps and a sampling frequency of 44.1 kHz.
- There is a wide variety of freeware and other encoding software for MP3 and WMA files on the market, and depending on the status of the encoding and the file format, poor sound quality or noise at the start of playback may result. In some cases, playback may not be possible at all.
- Microsoft, Windows, and Windows Media are registered trademarks of Microsoft Corporation in the U.S.A. and other countries.

 **CAUTION**

 **While driving**

Do not connect USB memory or operate the controls.

3-2. Using the audio system

NOTICE

■ To prevent damage to USB memory

- Do not leave USB memory in the vehicle. The temperature inside the vehicle may become high, resulting in damage to the player.
- Do not push down on or apply unnecessary pressure to the USB memory while it is connected as this may damage the USB memory or its terminal.
- Do not insert foreign objects into the port as this may damage the USB memory or its terminal.

امداد خودرو فارما

تلفن شبانه روزی: ۰۲۱-۸۸۸۶۲۰۸۵

FarmaSOS.com

3-2. Using the audio system Optimal use of the audio system

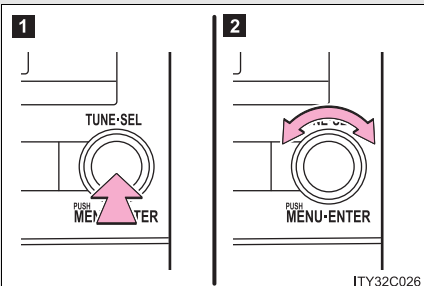

1 Displays the current mode

2 Changes the following settings

- Sound quality and volume balance

The sound quality and balance setting can be changed to produce the best sound.

- Automatic Sound Levelizer on/off

Adjusting sound quality and volume balance

■ Changing sound quality modes

Pressing  selects the mode to be changed in the following order.

“BAS” → “MID” → “TRE” → “FAD” → “BAL” → “ASL”

FarmaSOS.com

3

Interior features

3-2. Using the audio system



■ Adjusting sound quality

Turning  adjusts the level.

Sound quality mode	Mode displayed	Level	Turn to the left	Turn to the right
Low-pitched tones*	BAS	-5 to 5	Low	High
Mid-pitched tones*	MID	-5 to 5		
High pitched tones*	TRE	-5 to 5		
Front/rear volume balance	FAD	F7 to R7	Shifts to rear	Shifts to front
Left/right volume balance	BAL	L7 to R7	Shifts to left	Shifts to right

*: The sound quality level is adjusted individually in each audio mode.

Turning the Automatic Sound Levelizer (ASL) on/off

Turning  clockwise turns on the ASL, and turning  counterclockwise turns off the ASL.

ASL automatically adjusts the volume and tone quality according to the noise level as you drive your vehicle.

3-2. Using the audio system Using the AUX port

This port can be used to connect a portable audio device and listen to it using the vehicle's speakers.

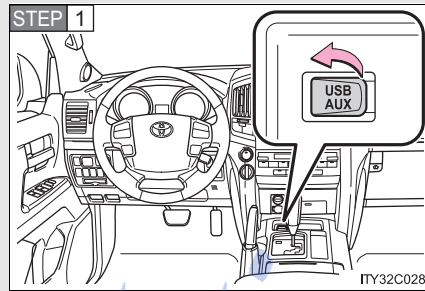

Open the cover and connect the portable audio device.

STEP 2 Press  .

■ Operating portable audio devices connected to the audio system

The volume can be adjusted using the vehicle's audio controls. All other adjustments must be made on the portable audio device itself.

3

Interior features

FarmaSOS.com

3-2. Using the audio system Using the steering switches

Some audio features can be controlled using the switches on the steering wheel.

Operation may differ depending on the type of audio system or navigation system. For details, refer to the manual provided with the audio system or navigation system.

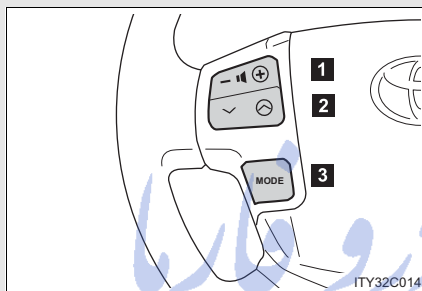

1 Volume

2 Radio mode: Selects a radio station

CD mode: Selects a track, file (MP3 and WMA) and disc

Bluetooth® audio mode: Selects a track and album

iPod mode: Selects a song

USB memory mode: Selects a file and folder

3 Power on, select audio source

Turning on the power

Press  when the audio system is turned off.

The audio system can be turned off by holding the switch down until you hear a beep.

Changing the audio source

Press  when the audio system is turned on. The audio source changes as follows each time the button is pressed. If a mode cannot be used, it will be skipped.

Type A:

FM1 → FM2 → SAT1 → SAT2 → SAT3 → CD player → Bluetooth® audio → AUX → iPod or USB memory → AM

Type B:

FM1 → FM2 → CD player → Bluetooth® audio → AUX → iPod or USB memory → AM

Adjusting the volume

Press "+" on  to increase the volume and "-" to decrease the volume.

Hold down the button to continue increasing or decreasing the volume.

Selecting a radio station

STEP 1 Press  to select the radio mode.

STEP 2 Press "∧" or "∨" on  to select a radio station.

To scan for receivable stations, press and hold the switch until you hear a beep.

3-2. Using the audio system

Selecting a track/file or song

STEP 1 Press  to select CD, Bluetooth® audio, iPod or USB memory mode.

STEP 2 Press “^” or “v” on  to select the desired track/file or song.

Selecting an album

STEP 1 Press  to select Bluetooth® audio mode.

STEP 2 Press and hold “^” or “v” on  until you hear a beep.

Selecting a folder

STEP 1 Press  to select USB memory mode.

STEP 2 Press and hold “^” or “v” on  until you hear a beep.

Selecting a disc in the CD player

STEP 1 Press  to select the CD mode.

STEP 2 Press and hold “^” or “v” on  until you hear a beep.

■ **Canceling automatic selection of a radio station**

Press  again.

 **CAUTION**

■ **To reduce the risk of an accident**

Exercise care when operating the audio switches on the steering wheel.

امداد خودرو فارما

تلفن شبانه روزی: ۰۲۱-۸۸۸۶۲۰۸۵

FarmaSOS.com

3-3. Using the Bluetooth® audio system

Bluetooth® audio system

The Bluetooth® audio system enables you to enjoy music played on a portable digital audio player (portable player) from the vehicle speakers via wireless communication.

This audio system supports Bluetooth®, a wireless data system capable of playing portable audio music without cables. If your portable player does not support Bluetooth®, the Bluetooth® audio system will not function.

- ▶ Vehicles with a navigation system
Refer to the “Navigation System Owner’s Manual”.
- ▶ Vehicles without a navigation system

Title	Page
Using the Bluetooth® audio system	P. 406
Operating a Bluetooth® enabled portable player	P. 412
Setting up a Bluetooth® enabled portable player	P. 415
Bluetooth® audio system setup	P. 422

■ Conditions under which the system will not operate

- If using a portable player that does not support Bluetooth®
- If the portable player is switched off
- If the portable player is not connected
- If the portable player’s battery is low
- If the portable player is behind the seat or in the glove box or console box
- If metal is covering or touching the portable player

■ **When transferring ownership of the vehicle**

Be sure to initialize the system to prevent personal data from being improperly accessed. (→P. 452)

■ **About Bluetooth®**



Bluetooth is a registered trademark of Bluetooth SIG, Inc.

■ **Compatible models**

- Bluetooth® specifications:
Ver. 1.2, or higher (Recommended: Ver. 2.0+EDR or higher)
- Following Profiles:
 - A2DP (Advanced Audio Distribution Profile) Ver. 1.0 or higher
 - AVRCP (Audio/Video Remote Control Profile) Ver. 1.0 or higher (Ver. 1.3 or higher recommended)

Portable players must correspond to the above specifications in order to be connected to the Bluetooth® audio system. However, please note that some functions may be limited depending on the type of portable player.

Please go to “<http://www.toyota.com/bluetooth>” to find approved Bluetooth® phones for this system.

■ **Certification for the Bluetooth® audio system**

FCC ID: AJDK018
MADE IN JAPAN

This device complies with Part 15 of the FCC Rules and RSS-Gen of IC Rules. Operation is subject to the following two conditions: (1) This device may not cause harmful interference, and (2) This device must accept any interference received, including interference that may cause undesired operation.

3-3. Using the Bluetooth® audio system

CAUTION

■ FCC WARNING

Changes or modifications not expressly approved by the party responsible for compliance could void the user's authority to operate the equipment.

Radio Frequency Radiation Exposure. This equipment complies with FCC radiation exposure limits set forth for uncontrolled equipment and meets the FCC radio frequency (RF) Exposure Guidelines in Supplement C to OET65. This equipment has very low levels of RF energy that it is deemed to comply without maximum permissive exposure evaluation (MPE). But it is desirable that it should be installed and operated with at least 7.9 in. (20 cm) and more between the radiator and person's body (excluding extremities: hands, wrists, feet and legs).

This transmitter must not be co-located or operated in conjunction with any other antenna or transmitter.

■ While driving

Do not connect portable players or operate the controls.

■ Caution regarding interference with electronic devices

- Your audio unit is fitted with Bluetooth® antennas. People with implantable cardiac pacemakers, cardiac resynchronization therapy-pacemakers or implantable cardioverter defibrillators should maintain a reasonable distance between themselves and the Bluetooth® antennas. The radio waves may affect the operation of such devices.
- Before using Bluetooth® devices, users of any electrical medical device other than implantable cardiac pacemakers, cardiac resynchronization therapy-pacemakers or implantable cardioverter defibrillators should consult the manufacturer of the device for information about its operation under the influence of radio waves. Radio waves could have unexpected effects on the operation of such medical devices.

 NOTICE

■ **To prevent damage to portable players**

Do not leave portable players in the vehicle. The temperature inside the vehicle may become high, resulting in damage to the player.

امداد خودرو فارما

تلفن شبانه روزی: ۰۲۱-۸۸۸۶۲۰۸۵

FarmaSOS.com

3-3. Using the Bluetooth® audio system

Using the Bluetooth® audio system

■ Audio unit

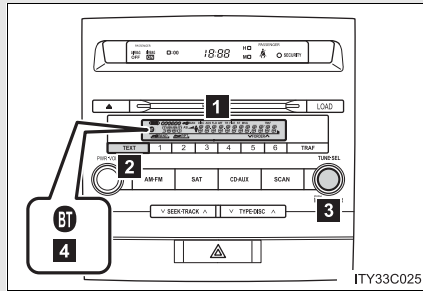

1 Display

A message, name, number, etc. is displayed.

Lower-case characters and special characters cannot be displayed.

2 Displays information that is too long to be displayed at one time on the display (press and hold)

3 Selects items such as menu and number

Turn: Selects an item

Press: Inputs the selected item

4 Bluetooth® connection condition

If "BT" is not displayed, the Bluetooth® audio system cannot be used.

Operating the system using voice commands

By following voice guidance instructions output from the speaker, voice commands enable to the operation of the Bluetooth® audio system without the need to check the display or operate  .

■ Operation procedure when using voice commands

Press the talk switch and follow voice guidance instructions.

■ Auxiliary commands when using voice commands

The following auxiliary commands can be used when operating the system using a voice command:

Cancel: Exits the Bluetooth® audio system

Repeat: Repeats the previous voice guidance instruction

Go back: Returns to the previous procedure



Help: Reads aloud the function summary if a help comment is registered for the selected function

FarmaSOS.com

3-3. Using the Bluetooth® audio system

Using the Bluetooth® audio system for the first time

Before using the Bluetooth® audio system, it is necessary to register a Bluetooth® enabled portable player in the system. Follow the procedure below to register (pair) a portable player:

STEP 1 Press  and select “BT•A MENU” using .

STEP 2 Press the talk switch or select “BT•A Setup” using .

The introductory guidance and portable player name registration instructions are heard.

STEP 3 Select “Pair Audio Player (Pair Audio)” using a voice command or .

STEP 4 Register a portable player name by either of the following methods: *تلفن شبانه روزی: ۰۸۵ +۸۸۶۲-۸۸۸۸*

- Select “Record Name” using , and say the name to be registered.
- Press the talk switch and say the name to be registered.

A voice guidance instruction to confirm the input is heard.

3-3. Using the Bluetooth® audio system

STEP 5 Select “Confirm” using a voice command or  .

A passkey is displayed and heard, and a voice guidance instruction for inputting the passkey into the portable player is heard.

STEP 6 Input the passkey into the portable player.

Refer to the manual that comes with the portable player for the operation of the portable player.

Guidance for registration completion is heard.

If the portable player has a Bluetooth® phone, the phone can be registered at the same time. A voice guidance instruction to register a Bluetooth® phone is heard.

STEP 7 Select “Yes” or “No” using a voice command or  .
(Bluetooth® phone →P. 423)

3

Interior features

تلفن شبانه روزی: ۰۲۱-۸۸۶۲۰۸۵

FarmaSOS.com

3-3. Using the Bluetooth® audio system

Menu list of the Bluetooth® audio system

■ Normal operation

First menu	Second menu	Third menu	Operation detail
"Setup"	"BT•A Setup"	"Pair Audio"	Registering a portable player
		"Connect"	Selecting a portable player to be used
		"Change Name"	Changing the registered name of a portable player
		"List Audios"	Listing the registered portable players
		"Set Passkey"	Changing the passkey
	"System Setup"	"Delete Audio"	Deleting a registered portable player
		"Guidance Vol"	Setting voice guidance volume
		"Device Name"	Displaying the Bluetooth® device address and name
		"Initialize"	Initializing the system

■ **When using a voice command**

For numbers, say a combination of single digits from zero to nine.
Say the command correctly and clearly.

■ **Situations that the system may not recognize your voice**

- When driving on rough roads
- When driving at high speeds
- When air is blowing out of the vents onto the microphone
- When the air conditioning fan emits a loud noise

■ **Operations that cannot be performed while driving**

- Operating the system with  (TUNE SEL)
- Registering a portable player to the system

■ **Changing the passkey**

→P. 420

تلفن شبانه روزی: ۰۲۱-۸۸۶۲۰۸۵

FarmaSOS.com

3-3. Using the Bluetooth® audio system Operating a Bluetooth® enabled portable player

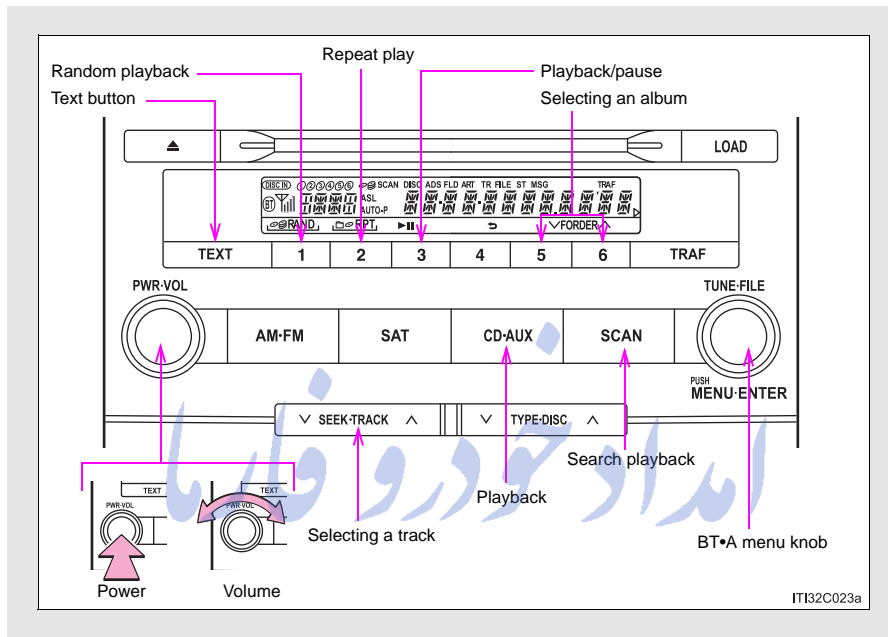

Selecting an album

To select the desired album, press (∨) or (∧).

Selecting tracks

Press "∧" or "∨" on to select the desired track.

Playing and pausing tracks

To play or pause a track, press (▶||).

Fast-forwarding and rewinding tracks

To fast-forward or rewind, press and hold “^” or “v” on until you hear a beep.

Random playback

Press (RAND).

To cancel, press (RAND) again.

Repeat play

Press (RPT).

To cancel, press (RPT) again.

Scanning tracks

Press .

To cancel, press again.

3-3. Using the Bluetooth® audio system

Switching the display

Press .

Each time the button is pressed, the display changes in the following order: Elapsed time → Album title → Track title → Artist name

Using the steering wheel audio switches

→P. 398

■ Bluetooth® audio system functions

Depending on the portable player that is connected to the system, certain functions may not be available.

■ Display

→P. 369

■ Error messages

“Memory Error”: This indicates a problem in the system.

FarmaSOS.com

3-3. Using the Bluetooth® audio system Setting up a Bluetooth® enabled portable player

Registering a portable player in the Bluetooth® audio system allows the system to function. The following functions can be used for registered portable players:

■ Functions and operation procedures

▶ Pattern A

To enter the menu for each function, follow the steps below using a

voice command or  :

- Registering a portable player
 1. "Setup" → 2. "Bluetooth Audio Setup (BT•A Setup)" → 3. "Pair Audio Player (Pair Audio)"
- Selecting a portable player to be used
 1. "Setup" → 2. "Bluetooth Audio Setup (BT•A Setup)" → 3. "Connect Audio Player (Connect)"
- Changing the registered name of a portable player
 1. "Setup" → 2. "Bluetooth Audio Setup (BT•A Setup)" → 3. "Change Name"
- Listing the registered portable players
 1. "Setup" → 2. "Bluetooth Audio Setup (BT•A Setup)" → 3. "List Audio Players (List Audios)"
- Changing the passkey
 1. "Setup" → 2. "Bluetooth Audio Setup (BT•A Setup)" → 3. "Set Passkey"
- Deleting a registered portable player
 1. "Setup" → 2. "Bluetooth Audio Setup (BT•A Setup)" → 3. "Delete Audio Player (Delete Audio)"

3-3. Using the Bluetooth® audio system

► Pattern B

STEP 1 Press  to select “BT•A MENU”.

STEP 2 Press the talk switch or select “BT•A Setup” using .

STEP 3 Select one of the following functions using a voice command or .

- Registering a portable player
“Pair Audio Player (Pair Audio)”
- Selecting a portable player to be used
“Connect Audio Player (Connect)”
- Changing the registered name
“Change Name”
- Listing the registered portable players
“List Audio Players (List Audios)”
- Changing the passkey
“Set Passkey”
- Deleting a registered portable player
“Delete Audio Player (Delete Audio)”

Registering a portable player

Select “Pair Audio Player (Pair Audio)” using a voice command or

 , and perform the procedure for registering a portable player.
(→P. 408)

Selecting a portable player to be used

STEP 1 Select “Connect Audio Player (Connect)” using a voice com-

mand or  .

► Pattern A

STEP 2 Select the portable player to be used by either of the following methods, and select “Confirm” by using a voice command or



a. Press the talk switch and say the name of the desired portable player.

b. Press the talk switch and say “List Audio Players”. When the name of the desired portable player is read aloud, press the talk switch.

► Pattern B

STEP 2 Select the portable player to be used using  .

3-3. Using the Bluetooth® audio system

► Pattern A

STEP 3 Press the talk switch and say “From Car” or “From Audio player”, and select “Confirm” by using a voice command or



► Pattern B

STEP 3 Select “From Car” or “From Audio”, using .

If “From Car” is selected, the portable player will be automatically connected whenever the “ENGINE START STOP” switch is in either ACCESSORY or IGNITION ON mode.

Changing the registered name of a portable player

STEP 1 Select “Change Name” using a voice command or .

► Pattern A

STEP 2 Select the name of the portable player to be changed by either of the following methods, and select “Confirm” using a

voice command or .

- a. Press the talk switch and say the name of desired portable player.
- b. Press the talk switch and say “List Audio Players”. When the name of the desired portable player is read aloud, press the talk switch.

► Pattern B

STEP 2 Select the desired portable player name to be changed using



STEP 3 Press the talk switch or select "Record Name" using , and say the new name.

STEP 4 Select "Confirm" using a voice command or .

Listing the registered portable players

Select "List Audio Players (List Audios)" using a voice command or



. The list of registered portable players will be read aloud.

When listing is complete, the system returns to "BT•A Setup".

Pressing the talk switch while the name of a portable player is being read aloud selects the portable player, and the following functions will become available:

- Selecting a portable player: "Connect Audio Player (Connect)"
- Changing a registered name: "Change Name"
- Deleting a portable player: "Delete Audio Player (Delete Audio)"

3-3. Using the Bluetooth® audio system

Changing the passkey

STEP 1 Select “Set Passkey” using a voice command or  .

► Pattern A

STEP 2 Press the talk switch, say a 4 to 8-digit number, and select “Confirm” using a voice command or  .

► Pattern B

STEP 2 Select a 4 to 8-digit number using  .
The number should be input 1 digit at a time.

STEP 3 When the entire number to be registered as a passkey has been input, press  again.
If the number to be registered has 8 digits, pressing of the knob is not necessary.

Deleting a registered portable player

STEP 1 Select “Delete Audio Player (Delete Audio)” using a voice command or  .

► Pattern A

STEP 2 Select the portable player to be deleted by either of the following methods and select “Confirm” using a voice command or



- a. Press the talk switch and say the name of the desired portable player.
- b. Press the talk switch and say “List Audio Players”. When the name of the desired portable player is read aloud, press the talk switch.

► Pattern B

STEP 2 Select the desired portable player to be deleted using  .

If the portable player to be deleted is paired as a Bluetooth® phone, the registration of the mobile phone can be deleted at the same time. A voice guidance instruction to delete a mobile phone is heard.

STEP 3 Select “Yes” or “No” using a voice command or  .

(Bluetooth® phone →P. 423)

■ **The number of portable players that can be registered**

Up to 2 portable players can be registered in the system.

3-3. Using the Bluetooth® audio system Bluetooth® audio system setup

■ System setup items and operation procedures

▶ Pattern A

To enter the menu for each function, follow the steps below using a

voice command or  :

(→P. 447)

▶ Pattern B

STEP 1 Press  to select “BT•A MENU”.

STEP 2 Select “System Setup” using  .

STEP 3 Select one of the following items using  :

- Setting voice guidance volume
“Guidance Vol” (→P. 450)
- Displaying the Bluetooth® device address and name
“Device Name” (→P. 451)
- Initializing the system
“Initialize” (→P. 451)

3-4. Using the hands-free system (for cellular phone) Hands-free system (for cellular phone)

The hands-free system is a function that allows you to use your cellular phone without touching it.

This system supports Bluetooth[®], which allows you to make or receive calls without using cables to connect a cellular phone and the system, and without operating the cellular phone.

- ▶ With navigation system
Refer to the "Navigation System Owner's Manual".
- ▶ Without navigation system

Title	Page
Using the hands-free system	P. 428
Making a phone call	P. 436
Setting a cellular phone	P. 441
Security and system setup	P. 447
Using the phone book	P. 453

3-4. Using the hands-free system (for cellular phone)

■ Conditions under which the system will not operate

- If using a mobile phone that does not support Bluetooth®
- If the mobile phone is switched off
- If you are outside service range
- If the mobile phone is not connected
- If the mobile phone's battery is low
- If the mobile phone is behind the seat or in the glove box or console box
- If metal is covering or touching the phone

■ When using the hands-free system

- The audio system and voice guidance are muted when making a call.
- If both parties speak at the same time, it may be difficult to hear.
- If the incoming call volume is overly loud, an echo may be heard.
- Try to face toward the microphone as much as possible when speaking.
- In the following circumstances, it may be difficult to hear the other party:
 - When driving on unpaved roads
 - When driving at high speeds
 - When a window is open
 - When the air conditioning is blowing directly on the microphone
 - When the air conditioning is set to high

■ When transferring ownership of the vehicle

Be sure to initialize the system to prevent the personal data from being improperly accessed.

3-4. Using the hands-free system (for cellular phone)

■ About Bluetooth®



Bluetooth is a registered trademark of Bluetooth SIG, Inc.

■ Compatible models

Compatible with HFP (Hands Free Profile) Ver. 1.5 and OPP (Object Push Profile) Ver. 1.1.

If your cellular phone does not support HFP, you cannot enter the Bluetooth® phone. If your cellular phone supports OPP alone, you cannot use the Bluetooth® phone.

Please go to "<http://www.toyota.com/bluetooth>" to find approved Bluetooth® phones for this system.

■ Certification for the hands-free system

FCC ID: AJDK018

MADE IN JAPAN

This device complies with Part 15 of the FCC Rules. Operation is subject to the following two conditions: (1) this device may not cause harmful interference, and (2) this device must accept any interference received, including interference that may cause undesired operation.

3-4. Using the hands-free system (for cellular phone)

CAUTION

■ FCC WARNING

Changes or modifications not expressly approved by the party responsible for compliance could void the user's authority to operate the equipment.

Radio Frequency Radiation Exposure. This equipment complies with FCC radiation exposure limits set forth for uncontrolled equipment and meets the FCC radio frequency (RF) Exposure Guidelines in Supplement C to OET65. This equipment has very low levels of RF energy that it deemed to comply without maximum permissive exposure evaluation (MPE). But it is desirable that it should be installed and operated with at least 7.9 in. (20 cm) and more between the radiator and person's body (excluding extremities: hands, wrists, feet and legs).

This transmitter must not be co-located or operated in conjunction with any other antenna or transmitter.

■ While driving

Do not use a cellular phone, or connect the Bluetooth® phone.

■ Caution regarding interference with electronic devices

- Your audio unit is fitted with Bluetooth® antennas. People with implantable cardiac pacemakers, cardiac resynchronization therapy-pacemakers or implantable cardioverter defibrillators should maintain a reasonable distance between themselves and the Bluetooth® antennas. The radio waves may affect the operation of such devices.
- Before using Bluetooth® devices, users of any electrical medical device other than implantable cardiac pacemakers, cardiac resynchronization therapy-pacemakers or implantable cardioverter defibrillators should consult the manufacturer of the device for information about its operation under the influence of radio waves. Radio waves could have unexpected effects on the operation of such medical devices.

3-4. Using the hands-free system (for cellular phone)

 NOTICE

■ **To prevent damage to a cellular phone**

Do not leave a cellular phone in the vehicle. The temperature inside may become high resulting in damage to the phone.

امداد خودرو فارما

تلفن شبانه روزی: ۰۲۱-۸۸۸۶۲۰۸۵

FarmaSOS.com

3

Interior features

3-4. Using the hands-free system (for cellular phone) Using the hands-free system

■ Audio unit

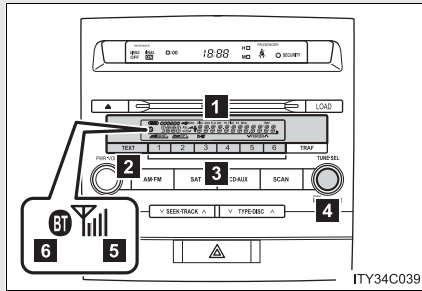

1 Display

A message, name, phone number, etc. is displayed.

Lower-case characters and special characters cannot be displayed.

2 Displays information that is too long to be displayed at one time on the display (press and hold)

3 Selects speed dials

4 Selects items such as menu and number

Turn: Selects an item

Press: Inputs the selected item

5 Reception level

6 Bluetooth® connection condition

If "BT" is not displayed, the hands-free system cannot be used.

3-4. Using the hands-free system (for cellular phone)

■ Steering wheel

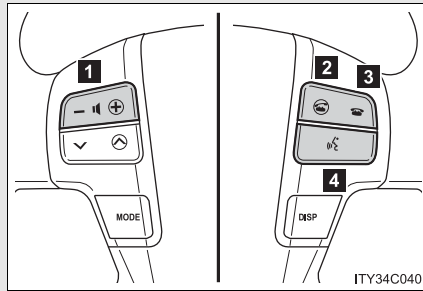

1 Volume

The voice guidance volume cannot be adjusted by using this button.

2 Off-hook switch

Turns the hands-free system on/start a call

3 On-hook switch

Turns the hands-free system off/ends a call/refuse a call

4 Talk switch

Turns the voice command system on (press)/turns the voice command system off (press and hold)

■ Microphone

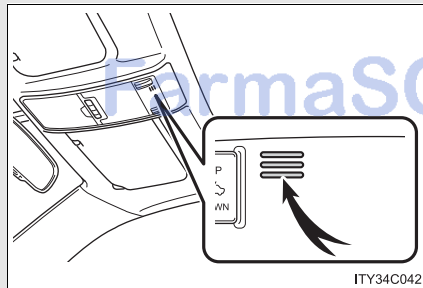

3-4. Using the hands-free system (for cellular phone)

Operating the system by using a voice command

By following voice guidance instructions output from the speaker, voice commands enable to the operation of the hands-free system

without need to check the display or operate  .

■ **Operation procedure when using a voice command**

Press the talk switch and follow voice guidance instructions.

■ **Auxiliary commands when using a voice command**

The following auxiliary commands can be used:

Cancel: Exits the hands-free system

Repeat: Repeats the previous voice guidance instruction

Go back: Returns to the previous procedure

Help: Reads aloud the function summary if a help comment is registered for the selected function

Using the hands-free system for the first time

Before using the hands-free system, it is necessary to register a cellular phone in the system. The system will enter phone registration mode automatically when starting the system with no cellular phone registered. Follow the procedure below to register (pair) a cellular phone:

3-4. Using the hands-free system (for cellular phone)

STEP 1 Press the off-hook switch or the talk switch.

The introductory guidance and phone name registration instructions are heard.

STEP 2 Select “Pair Phone” using a voice command or  .

STEP 3 Register a phone name by either of the following methods.

- a. Select “Record Name” using  , and say the name to be registered.
- b. Press the talk switch and say the name to be registered.

A voice guidance instruction to confirm the input is heard.

STEP 4 Select “Confirm” using a voice command or  .

A passkey is displayed and heard, and a voice guidance instruction for inputting the passkey into the cellular phone is heard.

STEP 5 Input the passkey into the cellular phone.

Refer to the manual that comes with the cellular phone for the operation of the phone.

Guidance for registration completion is heard.

If the cellular phone has a Bluetooth® audio player, the audio player can be registered at the same time. A voice guidance instruction to register a Bluetooth® audio player is heard.

STEP 6 Select “Yes” or “No” using a voice command or  .
(Bluetooth® audio player →P. 402)

3-4. Using the hands-free system (for cellular phone)

Menu list of the hands-free system

■ Normal operation

First menu	Second menu	Third menu	Operation detail
Callback	—	—	Dialing a number stored in the incoming call history memory
Redial	—	—	Dialing a number stored in the outgoing call history memory
Phone-book	Add Entry	—	Adding a new number
	Change Name	—	Changing a name in the phone book
	Delete Entry	—	Deleting the phone book data
	Delete Speed Dial (Del Spd Dial)	—	Deleting a registered speed dial
	List Names	—	List the phone book data
	Set Speed Dial (Speed Dial)	—	Registering a speed dial

3-4. Using the hands-free system (for cellular phone)

First menu	Second menu	Third menu	Operation detail
Setup	Security	Set PIN	Setting a PIN code
		Phbk Lock	Locking the phone book
		Phbk Unlock	Unlocking the phone book
	Phone Setup	Pair Phone	Registering a cellular phone to be used
		Connect	Selecting a cellular phone to be used
		Change Name	Changing a registered name of a cellular phone
		List phones	Listing the registered cellular phones
		Set Passkey	Changing the passkey
		Delete	Deleting a registered cellular phone
		Guidance Volume (Guidance Vol)	Setting voice guidance volume
	System Setup	Device Name	Displaying the Bluetooth® device address and name
		Initialize	Initialization

3

Interior features

3-4. Using the hands-free system (for cellular phone)

■ Using a short cut key

First menu	Second menu	Operation detail
Dial "XXX (name)"	—	Dialing a number registered in the phone book
Phone book add entry	—	Adding a new number
Phone book change name	—	Changing a name of a phone number in the phone book
Phone book delete entry	—	Deleting phone book data
Phone book list names	—	Listing the registered data
Phone book set speed dial	—	Registering a speed dial
Phone book delete speed dial	—	Deleting a speed dial
Dial XXX (number)	—	Dialing by inputting a number
Phonebook	Phonebook Unlock	Unlocking the phone book
	Phonebook Lock	Locking the phone book

FarmaSOS.com

3-4. Using the hands-free system (for cellular phone)

■ Automatic volume adjustment

When vehicle speed reaches 50 mph (80 km/h) or more, the volume automatically increases. The volume returns to the previous volume setting when vehicle speed drops to 43 mph (70 km/h) or less.

■ When using a voice command

- For numbers, say a combination of single digits from zero to nine, # (pound), * (star), and + (plus).
- Say a command correctly and clearly.

■ Situations that the system may not recognize your voice

- When driving on a rough road
- When driving at high speeds
- When air is blowing out of the vents onto the microphone
- When the air conditioning fan emits a loud noise

■ Operations that cannot be performed while driving

- Operating the system with 
- Registering a cellular phone to the system

■ Changing the passkey

→P. 445

3-4. Using the hands-free system (for cellular phone)

Making a phone call

■ Making a phone call

- Dialing by inputting a number
“Dial by number”
- Dialing by inputting a name
“Dial by name”
- Speed dialing
- Dialing a number stored in the outgoing history memory
“Redial”
- Dialing a number stored in the incoming history memory
“Call back”

■ Receiving a phone call

- Answering the phone
- Refusing the call

■ Transferring a call

■ Call waiting

■ Using a call history memory

- Dialing
- Storing data in the phone book
- Deleting

3-4. Using the hands-free system (for cellular phone)

Dialing by inputting a number

- STEP 1** Press the talk switch and say “Dial by number”.
- STEP 2** Press the talk switch and say the phone number.
- STEP 3** Dial by one of the following methods:
- Press the off-hook switch.
 - Press the talk switch and say “Dial”.
 - Select “Dial” using  .

Dialing by inputting a name

- STEP 1** Press the talk switch and say “Dial by name”.
- STEP 2** Select a registered name to be input by either of the following methods:
- Press the talk switch and say a registered name.
 - Press the talk switch and say “List names”. Press the talk switch when the desired name is being read aloud.
- STEP 3** Dial by one of the following methods:
- Press the off-hook switch.
 - Press the talk switch and say “Dial”.
 - Select “Dial” using  .

3-4. Using the hands-free system (for cellular phone)

Speed dialing

STEP 1 Press the off-hook switch.

STEP 2 Press the preset button in which the desired number is registered.

STEP 3 Press the off-hook switch.

When receiving a phone call

■ Answering the phone

Press the off-hook switch.

■ Refusing the call

Press the on-hook switch.

Transferring a call

A call can be transferred between the cellular phone and system while dialing, receiving a call, or during a call. Use one of the following methods:

a. Operate the cellular phone.

Refer to the manual that comes with the cellular phone for the operation of the phone.

b. Press the off-hook switch*¹.

c. Press the talk switch and say "Call Transfer"*².

*¹: This operation can be performed only when transferring a call from the cellular phone to the system during a call.

*²: While the vehicle is in motion, a call cannot be transferred from the system to the cellular phone.

3-4. Using the hands-free system (for cellular phone)

Call waiting

When a call is interrupted by an incoming call from a third party, the following options will become available:

- Answer the incoming call: Press the off-hook switch. (Press the off-hook switch again as necessary to switch back and forth between calls.)
- Refuse the incoming call: Press the on-hook switch.

Using the call history memory

Follow the procedure below to use a number stored in the call history memory:

STEP 1 Press the talk switch and say "Redial" (when using a number stored in the outgoing call history memory) or "Call back" (when using a number stored in the incoming call history memory).

STEP 2 Select the number by either of the following methods:

a. Say "Previous" or "Go back" until the desired number is displayed.

b. Select the desired number using



3-4. Using the hands-free system (for cellular phone)

STEP 3 The following operations can be performed:

Dialing: Press the off-hook switch or select “Dial” using a

voice command or  .

Storing the number in the phone book: Select “Store” and then

“Confirm” using a voice command or  .

Deleting: Select “Delete” and then “Confirm” using a voice

command or  .

■ Call waiting

- If your phone does not support HFP Ver. 1.5, this function cannot be used.
- Call waiting operation may differ depending on your cellular phone and service provider.

■ Call history

Up to 5 numbers can be stored in each of the outgoing and incoming call history memories.

■ When talking on the phone

- Do not talk simultaneously with the other party.
- Keep the volume of the receiving voice down. Otherwise, voice echo will increase.

3-4. Using the hands-free system (for cellular phone) Setting a cellular phone

Registering a cellular phone in the hands-free system allows the system to function. The following functions can be used for registered cellular phones:

■ Functions and operation procedures

To enter the menu for each function, follow the steps below.

STEP 1 Press the off-hook switch and select “Setup” using voice

command or .

STEP 2 Select “Phone Setup” using voice command or .

STEP 3 Select one of the following items using voice command or



- Registering a cellular phone
“Pair Phone”
- Selecting a cellular phone to be used
“Select Phone”
- Changing the registered name
“Change Name”
- Listing the registered cellular phones
“List Phones”
- Changing the passkey
“Set Passkey”
- Deleting a registered cellular phone
“Delete”

3-4. Using the hands-free system (for cellular phone)

Registering a cellular phone

Select “Pair Phone” using a voice command or , and perform the procedure for registering a cellular phone. (→P. 430)

Selecting a cellular phone to be used

STEP 1 Select “Connect Phone (Connect)” using a voice command or



► Pattern A

STEP 2 Select a cellular phone to be used by either of the following methods, and select “Confirm” using a voice command or



- Press the talk switch and say the name of the desired phone.
- Press the talk switch and say “List Phones”. When the name of the desired cellular phone is read aloud, press the talk switch.

► Pattern B

STEP 2 Select a cellular phone to be used using .

Changing the registered name of a cellular phone

STEP 1 Select "Change Name" using a voice command or  .

► Pattern A

STEP 2 Select a name of cellular phone to be changed by either of the following methods, and select "Confirm" using a voice command or

 .

- a. Press the talk switch and say the name of the desired phone.
- b. Press the talk switch and say "List phones". When the name of the desired phone is being read aloud, press the talk switch.

► Pattern B

STEP 2 Select the desired phone name to be changed by using

 .

STEP 3 Press the talk switch or select "Record Name" using  , and say a new name.

STEP 4 Select "Confirm" using a voice command or  .

Listing the registered cellular phones

Selecting “List Phones” using a voice command or  . The list of registered cellular phones to be read aloud.

When listing is complete, the system returns to “Phone Setup”.

Pressing the talk switch while a name of cellular phone is being read selects the cellular phone, and the following functions will become available:

- Selecting a cellular phone: “Connect Phone (Connect)”
- Changing a registered name: “Change Name”
- Deleting a cellular phone: “Delete Phone”

تلفن شبانه روزی: ۰۲۱-۸۸۸۶۲۰۸۵

FarmaSOS.com

3-4. Using the hands-free system (for cellular phone)

Changing the passkey

STEP 1 Select "Set Passkey" using a voice command or .

► Pattern A

STEP 2 Press the talk switch, say a 4 to 8-digit number, and select

"Confirm" using a voice command or .

► Pattern B

STEP 2 Select a 4 to 8-digit number using .

The number should be input 1 digit at a time.

STEP 3 When the entire number to be registered as a passkey has

been input, press  again.

If the number to be registered has 8 digits, pressing of the knob is not necessary.

3

Interior features

FarmaSOS.com

3-4. Using the hands-free system (for cellular phone)

Deleting a registered cellular phone

STEP 1 Select “Delete Phone” using a voice command or  .

► Pattern A

STEP 2 Select the cellular phone to be deleted by either of the following methods and select “Confirm” using a voice command or



- a. Press the talk switch and say the name of the desired cellular phone.
- b. Press the talk switch and say “List Phones”. While the name of the desired cellular phone is read aloud, press the talk switch.

► Pattern B

STEP 2 Select a desired cellular phone to be deleted using  .

If the cellular phone to be deleted is paired as a Bluetooth® audio player, the registration of the audio player can be deleted at the same time. A voice guidance instruction to delete a Bluetooth® audio player is heard.

STEP 3 Select “Yes” or “No” by using a voice command or  .

(Bluetooth® audio player →P. 402)

■ **The number of cellular phone that can be registered**

Up to 6 cellular phones can be registered in the system.

3-4. Using the hands-free system (for cellular phone) Security and system setup

■ Security setting items and operation procedure

To enter the menu for each function, follow the steps below.

STEP 1 Press the off-hook switch and select “Setup” using voice

command or .

STEP 2 Select “Security” using voice command or .

STEP 3 Select one of the following items using voice command or



- Setting or changing the PIN (Personal Identification Number)
“Set PIN”
- Locking the phone book
“Phonebook Lock (Phbk Lock)”
- Unlocking the phone book
“Phonebook Unlock (Phbk Unlock)”

3

Interior features

FarmaSOS.com

3-4. Using the hands-free system (for cellular phone)

■ System setup items and operation procedure

To enter the menu for each function, follow the steps below.

STEP 1 Press the off-hook switch and select "Setup" using  .

STEP 2 Select "System Setup" using  .

STEP 3 Select one of the following items using  .

- Setting voice guidance volume
"Guidance Vol"
- Displaying the Bluetooth® device address and name
"Device Name"
- Initializing the system
"Initialize"

FarmaSOS.com

Setting or changing the PIN

■ Setting a PIN

STEP 1 Select "Set PIN" using a voice command or  .

STEP 2 Enter a PIN using a voice command or  .

When using  , input the code 1 digit at a time.

■ Changing the PIN

STEP 1 Select "Set PIN" using a voice command or  .

STEP 2 Enter the registered PIN using a voice command or  .

STEP 3 Enter a new PIN using a voice command or  .

When using  , input the code 1 digit at a time.

FarmaSOS.com

3-4. Using the hands-free system (for cellular phone)

Locking or unlocking the phone book

STEP 1 Select “Phonebook Lock (Phbk Lock)” or “Phonebook Unlock

(Phbk Unlock)” using a voice command or  .

STEP 2 Input the PIN by either of the following methods and select

“Confirm” using a voice command or  :

a. Press the talk switch and say the registered PIN.

b. Input a new PIN using  .

Setting voice guidance volume

STEP 1 Select “Guidance Vol” using  .

STEP 2 Change the voice guidance volume. *تلفن شبانه روزی ۰۲۱-۸۸۸۶۲۰۸۸*

To decrease the volume: Turn  counterclockwise.

To increase the volume: Turn  clockwise. *FarmaSOS.com*

3-4. Using the hands-free system (for cellular phone)

Displaying the Bluetooth® device address and name

STEP 1 Select "Device Name" using  .

STEP 2 Turn  to display the Bluetooth® device address and name.

STEP 3 Select "Go Back" using  to return to "System Setup".

Initializing the system

STEP 1 Select "Initialize" and then "Confirm" using  .

STEP 2 Select "Confirm" again using  .

تلفن شبانه روزی: ۰۲۱-۸۸۸۶۲۰۸۵

FarmaSOS.com

3-4. Using the hands-free system (for cellular phone)

■ Initialization

- The following data in the system can be initialized:
 - Phone book
 - Outgoing and incoming call history
 - Speed dials
 - Registered cellular phone data
 - Security code
 - Registered Bluetooth® enabled portable player data
 - Passkey for the cellular phone
 - Passkey for the Bluetooth® audio players
 - Guidance volume
 - Receiver volume
 - Ring tone volume
- Once the initialization has been completed, the data cannot be restored to its original state.

■ When the phone book is locked

The following functions cannot be used:

- Dialing by inputting a name
- Speed dialing
- Dialing a number stored in the call history memory
- Using the phone book

3-4. Using the hands-free system (for cellular phone) Using the phone book

To enter the menu for each function, follow the steps below.

STEP 1 Press the off-hook switch and select “Phonebook” using voice command or  .

STEP 2 Select one of the following items using voice command or



- Adding a new phone number
“Add Entry”
- Changing the registered name in the phone book
“Change Name”
- Listing the registered data
“List Names”
- Setting speed dials
“Set Speed Dial (Speed Dial)”
- Deleting the registered data
“Delete Entry”
- Deleting speed dial
“Delete Speed Dial (Del Spd Dial)”

3-4. Using the hands-free system (for cellular phone)

Adding a new phone number

The following methods can be used to add a new phone number:

- Inputting a phone number using a voice command
- Transferring data from the cellular phone
- Inputting a phone number using 
- Selecting a phone number from outgoing or incoming call history

■ Adding procedure

STEP 1 Select “Add Entry” using a voice command or  .

STEP 2 Use one of the following methods to input a telephone number:

- ▶ Inputting a telephone number using a voice command

STEP2-1 Select “By Voice” using a voice command or



STEP2-2 Press the talk switch, say the desired number, and select “Confirm” using a voice command.

3-4. Using the hands-free system (for cellular phone)

► Transferring data from the cellular phone

STEP2-1 Select "By Phone" and then "Confirm" using a

voice command or  .

STEP2-2 Transfer the data from the cellular phone.

Refer to the manual that comes with the cellular phone for the details of transferring data.

STEP2-3 Select the data to be registered by either of the following methods:

a. Say "Previous" or "Next" until the desired data is displayed, and select "Confirm" using a voice command.

b. Select the desired data using  .

► Inputting a phone number using  تلفن شبانه روزی

STEP2-1 Select "Manual Input" using  .

STEP2-2 Input a phone number using  , and press

 again.

Input the phone number 1 digit at a time.

3-4. Using the hands-free system (for cellular phone)

► Selecting a phone number from outgoing or incoming call history

STEP2-1 Select “Call History” using a voice command or



STEP2-2 Select “Outgoing” or “Incoming” using a voice com-



STEP2-3 Select the data to be registered by either of the following methods:

a. Say “Previous” or “Go back” until the desired data is displayed, and select “Confirm” by using a voice command.

b. Select the desired data using .

STEP 3 Select the name to be registered by either of the following methods, and select “Confirm” using a voice command or



a. Press the talk switch and say the desired name.

b. Select “Record Name” using , and say the desired name.

3-4. Using the hands-free system (for cellular phone)

STEP 4 Select “Confirm” using a voice command or  again.

In **STEP 4**, selecting “Set Speed Dial (Speed Dial)” instead of “Confirm” registers the newly added phone number as speed dial.

Changing the registered name in the phone book

STEP 1 Select “Change Name” using a voice command or .

► Pattern A

STEP 2 Select the name to be changed by either of the following methods, and select “Confirm” using a voice command or



- Press the talk switch, say desired name.
- Press the talk switch, and say “List names”. While the desired name is read aloud, press the talk switch.

► Pattern B

STEP 2 Select the desired name to be changed using .

STEP 3 Press the talk switch or select “Record Name” using , and say the new name.

STEP 4 Select “Confirm” using a voice command or .

3

Interior features

3-4. Using the hands-free system (for cellular phone)

Listing the registered data

Select “List names” using a voice command or  . The list of the registered data will be read aloud.

When listing is complete, the system returns to “Phonebook”.

Pressing the talk switch while the desired data is being read aloud selects the data, and the following function will become available.

- Dialing: “Dial”
- Changing a registered name: “Change Name”
- Deleting an entry: “Delete Entry”
- Setting speed dial: “Set Speed Dial (Speed Dial)”

Setting speed dials

STEP 1 Select “Set Speed Dial (Speed Dial)” using a voice command

or  .

FarmaSOS.com

3-4. Using the hands-free system (for cellular phone)

► Pattern A

STEP 2 Select the data to be registered as a speed dial by either of the following methods, and select “Confirm” using a voice

command or  .

- a. Press the talk switch, say desired name.
- b. Press the talk switch, and say “List names”. When the desired name is read aloud, press the talk switch.

► Pattern B

STEP 2 Select the desired data using  .

STEP 3 Select the desired preset button, and register the data into speed dial by either of the following methods:

- a. Press the desired preset button, and select “Confirm” using a voice command or  .
- b. Press and hold the desired preset button.

3-4. Using the hands-free system (for cellular phone)

Deleting the registered data

STEP 1 Select “Delete Entry” using a voice command or  .

► Pattern A

STEP 2 Select the data to be deleted by either of the following meth-

ods, and select “Confirm” using a voice command or  :

- a. Press the talk switch, and say the name of the desired phone number.
- b. Press the talk switch, say “List Names”. When the name of the desired phone number is read aloud, press the talk switch.

► Pattern B

STEP 2 Select the data to be deleted using  .

تلفن شبانه روزی: ۰۲۱-۸۸۸۶۲۰۸۵

FarmaSOS.com

3-4. Using the hands-free system (for cellular phone)

Deleting speed dials

STEP 1 Select “Delete Speed Dial (Del Spd Dial)” using a voice com-

mand or  .

STEP 2 Press the preset button in which the desired speed dial is registered, and select “Confirm” using a voice command or

 .

■ Limitation of number of digits

A phone number that exceeds 24 digits cannot be registered.

3

Interior features

تلفن شبانه روزی: ۰۲۱-۸۸۶۲۰۸۵

FarmaSOS.com

3-5. Using the interior lights

Interior lights list

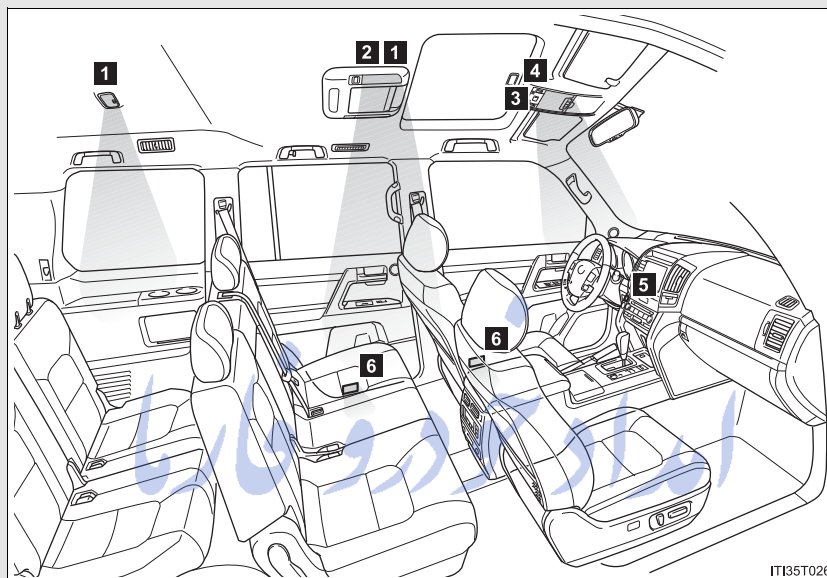

- 1** Rear interior lights (→P. 463)
- 2** Rear personal lights (→P. 464)
- 3** Front interior light (→P. 463)
- 4** Front personal lights (→P. 464)
- 5** "ENGINE START STOP" switch light
- 6** Door courtesy lights

Interior lights

► Front

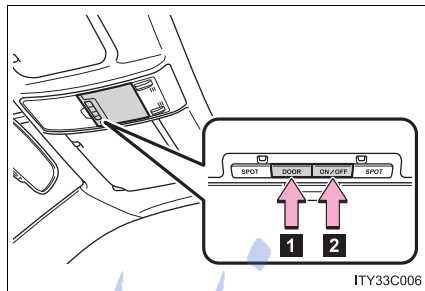

- 1** Door position on/off
- 2** On/off

► Rear

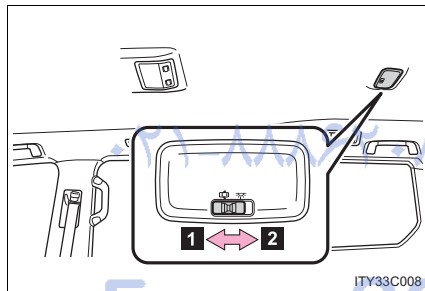

- 1** Door position
- 2** On

Personal lights

► Front

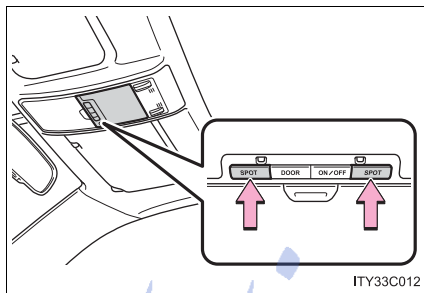

On/off

► Rear (type A)

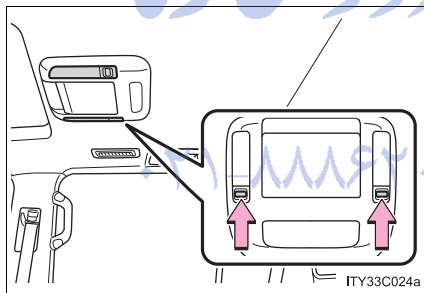

On/off

► Rear (type B)

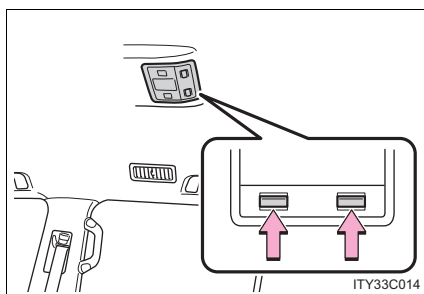

On/off

■ **Illuminated entry system**

The lights automatically turn on/off according to “ENGINE START STOP” switch mode, the presence of the electronic key, whether the doors are locked/unlocked, and whether the doors are open/closed.

■ **To prevent battery discharge**

If the interior lights remain on when the “ENGINE START STOP” switch is turned off, the lights will go off automatically after 20 minutes.

■ **Customization**

Settings (e.g. Time period before the interior lights turn off) can be changed. (Customizable features →P. 694)

امداد خودرو فارما

تلفن شبانه روزی: ۰۲۱-۸۸۸۶۲۰۸۵

FarmaSOS.com

3-6. Using the storage features

List of storage features

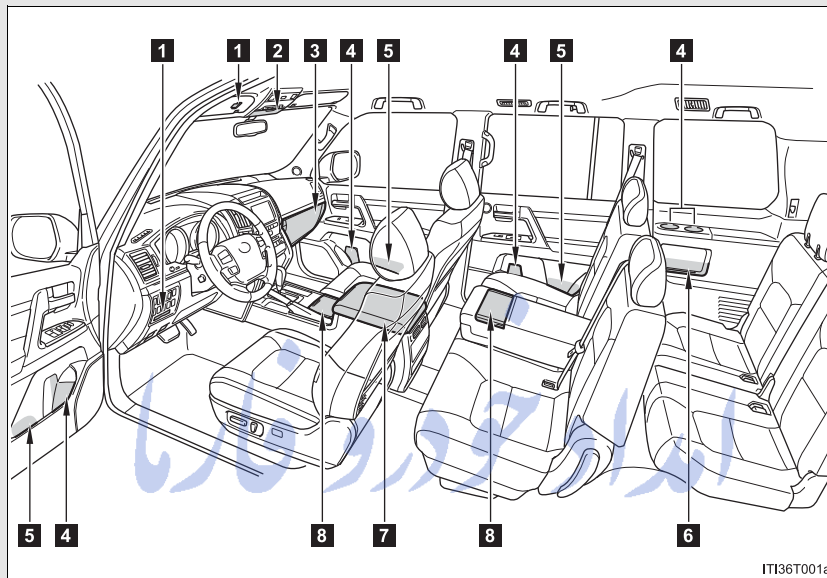

- | | |
|--------------------|-------------------|
| 1 Card holders | 5 Door pockets |
| 2 Overhead console | 6 Auxiliary boxes |
| 3 Glove box | 7 Console box |
| 4 Bottle holders | 8 Cup holders |
| | Cool box |

CAUTION

■ Items that should not be left in the storage spaces

Do not leave glasses, lighters or spray cans in the storage spaces, as this may cause the following when cabin temperature becomes high:

- Glasses may be deformed by heat or cracked if they come into contact with other stored items.
- Lighters or spray cans may explode. If they come into contact with other stored items, the lighter may catch fire or the spray can may release gas, causing a fire hazard.

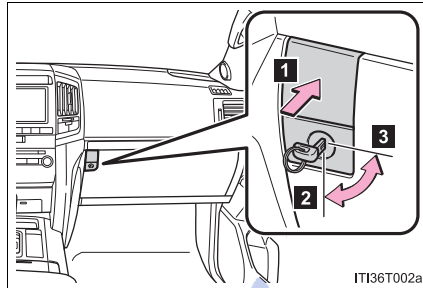
Glove box

- 1** Open (push button)
- 2** Lock with the mechanical key
- 3** Unlock with the mechanical key

- **Glove box light**

The glove box light turns on when the tail lights are on.

- **Removing the separate tray**

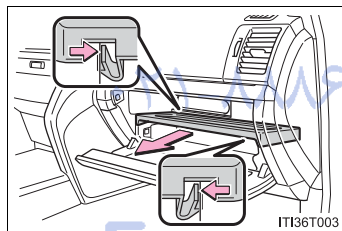

Pull out the separate tray.

⚠ CAUTION

- **While driving**

Keep the glove box closed.

Injuries may result in the event of sudden braking, sudden swerving or an accident.

Console box

Your vehicle is equipped with either a lower console box or cool box. For vehicles with the cool box, refer to page 475.

► Upper console box

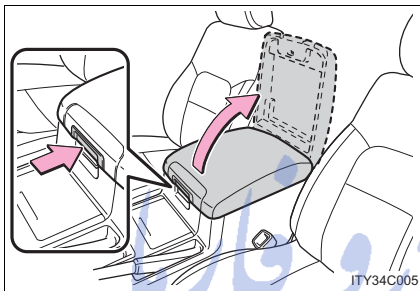

Press the tab to open.

► Lower console box (if equipped)

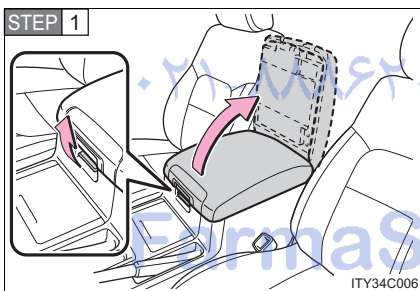

Lift the lever to open.

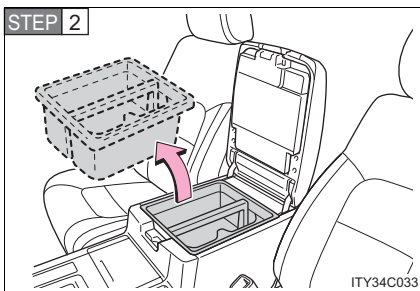

Remove the tray.

3-6. Using the storage features

Console box and overhead console

⚠ CAUTION

■ **While driving**

Keep the console box closed.

Injuries may result in the event of sudden braking, sudden swerving or an accident.

Overhead console

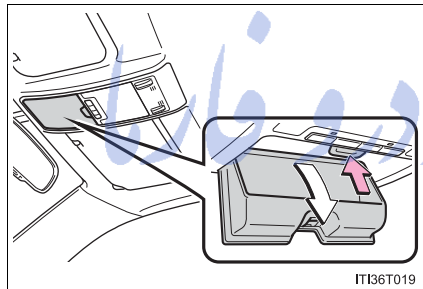

Press the button.

The overhead console is useful for temporarily storing small items.

⚠ CAUTION

■ **Items unsuitable for storing**

Do not store items heavier than 0.4 lb. (0.2 kg).

Doing so may cause the overhead console to open and the items inside may fall out, resulting in an accident.

■ **While driving**

Do not leave the overhead console open.

Items may fall out and cause injury.

Cup holders

► Front (type A)

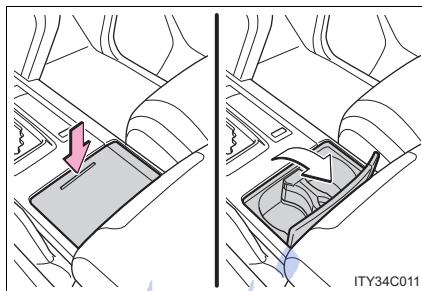

Press down and release the lid.

You can adjust or remove the separator inside.

► Front (if equipped with type B)

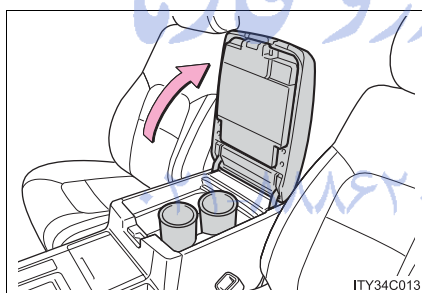

Open the lower console box lid.

► Rear

STEP 1 Pull the armrest down. (→P. 491)

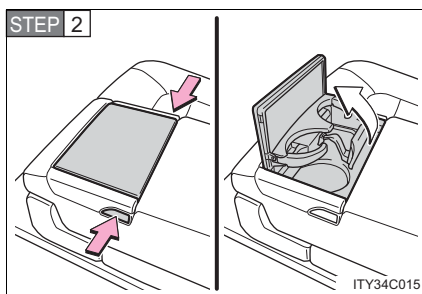

Press the button.

■ Removing the holder (front cup holders type A)

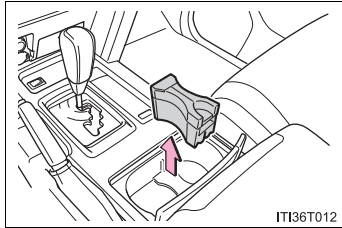

Pull up the holder.

⚠ CAUTION

■ Items unsuitable for the cup holder

Do not place anything other than cups or aluminum cans in the cup holders. Other items may be thrown out of the holders in the event of an accident or sudden braking and cause injury. If possible, cover hot drinks to prevent burns.

■ When not in use

Keep the cup holders closed.

Injuries may result in the event of sudden braking, sudden swerving or an accident.

⚠ NOTICE

■ To prevent damage to the cup holders (vehicles with a rear cup holder)

Stow the cup holders before stowing the rear armrest.

Bottle holders

► Front seats

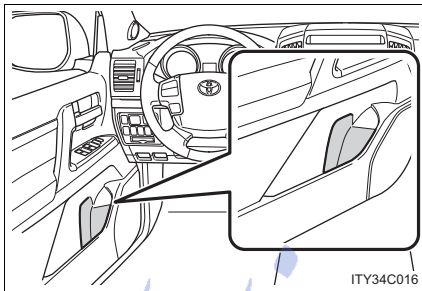

► Second seats

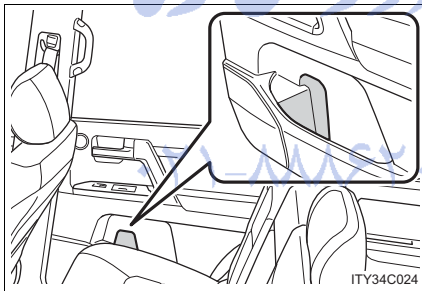

► Third seats

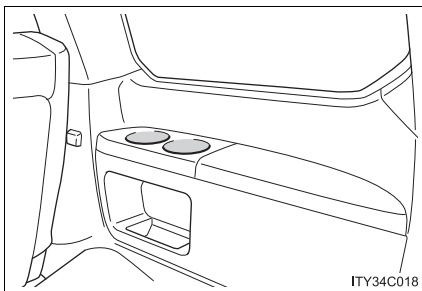

 NOTICE

■ **Items that should not be stowed in the bottle holders**

Put the cap on before stowing a bottle. Do not place open bottles in the bottle holders, or glasses and paper cups containing liquid. The contents may spill and glasses may break.

امداد خودرو فارما

تلفن شبانه روزی: ۰۲۱-۸۸۸۶۲۰۸۵

FarmaSOS.com

Card holders

► Sun visor

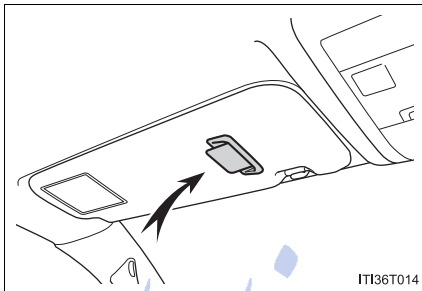

► Instrument panel

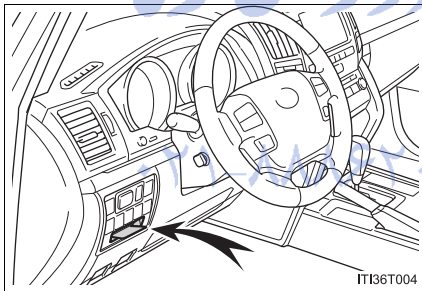

Auxiliary boxes

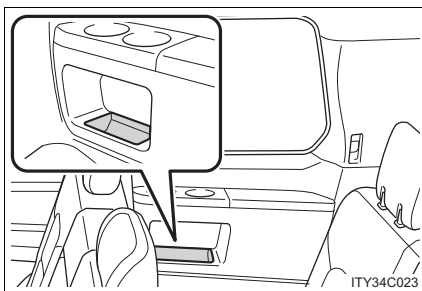

3-7. Other interior features

Cool box*

While the engine is running, the cool box, which is cooled by the air conditioning, can be used.

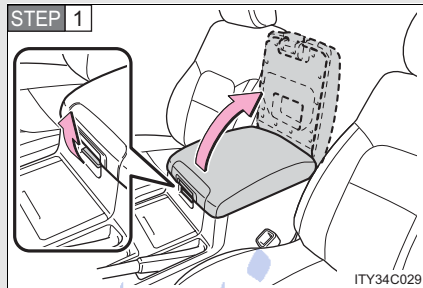

Lift the lever to open.

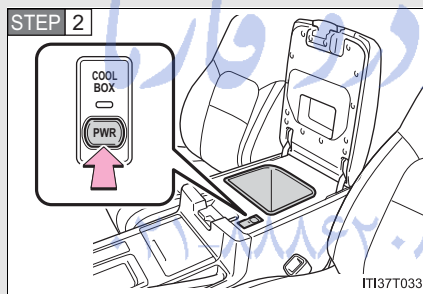

On/off

When on, the indicator light comes on.

If the front air conditioning system is not in use, the front air conditioning system is automatically turned on when the cool box is turned on.

■ While the cool box is on

The front air conditioning system cannot be turned off.

■ When the outside temperature is 32°F (0°C) or below

The cool box may not operate.

*: If equipped

3-7. Other interior features

CAUTION

■ While driving

Keep the cool box closed.

Injuries may result in the event of sudden braking, sudden swerving or an accident.

NOTICE

■ To prevent battery discharge

Do not leave the cool box on longer than necessary when the engine is stopped.

امداد خودرو فارما
تلفن شبانه روزی: ۰۲۱-۸۸۸۶۲۰۸۵

FarmaSOS.com

3-7. Other interior features

Sun visors

► Main sun visor

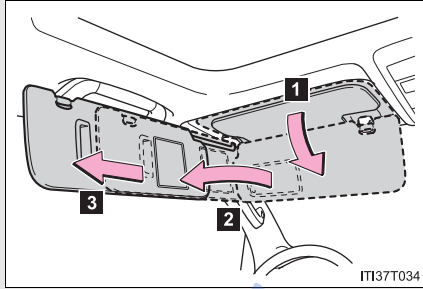

- 1** Forward position:
Flip down.
- 2** Side position:
Flip down, unhook, and swing to the side.
- 3** Side extender:
Place in side position, then slide backwards.

► Sub-sun visor

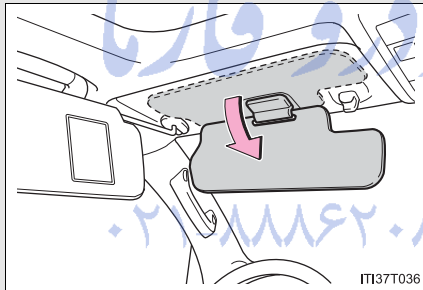

Flip down with the main sun visor in position **2** or **3**.

3

Interior features

FarmaSOS.com

3-7. Other interior features

Vanity mirror

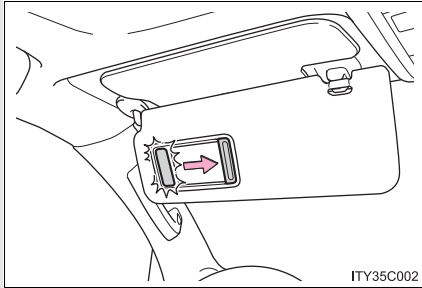

Slide the cover.

The light turns on when the cover is opened.

 **NOTICE**

To prevent battery discharge

Do not leave the vanity lights on for extended periods while the engine is off.

تلفن شبانه روزی: ۰۲۱-۸۸۶۲۰۸۵

FarmaSOS.com

3-7. Other interior features

Clock

- ▶ With navigation system
Refer to “Navigation System Owner’s Manual”.
- ▶ Without navigation system
The clock can be adjusted by pressing the buttons.

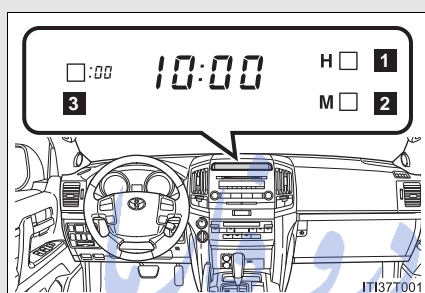

- 1 Adjust hours.
- 2 Adjust minutes.
- 3 Round the nearest hour.*
* :e.g. 1:00 to 1:29 → 1:00
1:30 to 1:59 → 2:00

■ The clock is displayed when

The “ENGINE START STOP” switch is in ACCESSORY or IGNITION ON mode.

■ When the battery is disconnected

The time display will automatically be set to 1:00.

3-7. Other interior features

Outside temperature display

The displayed temperature ranges from -22°F (-30°C) up to 122°F (50°C).

- ▶ Center panel (vehicles with navigation system)

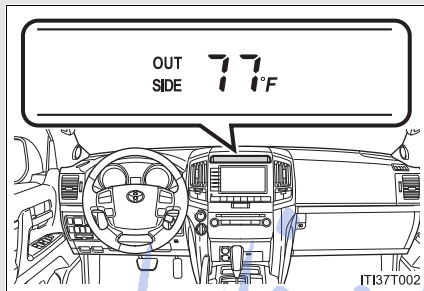

- ▶ Center panel (vehicles without navigation system)

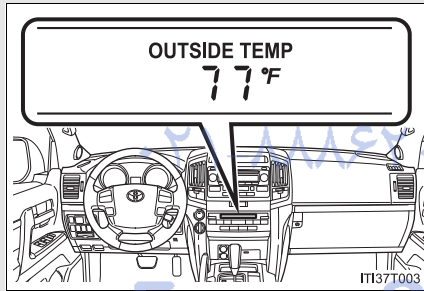

■ **Operating conditions**

The "ENGINE START STOP" switch is in IGNITION ON mode.

■ **When --- is displayed**

The system may be malfunctioning. Take your vehicle to your Toyota dealer.

■ **Display**

In the following situations, the correct outside temperature may not be displayed, or the display may take longer than normal to change.

- When stopped, or driving at low speeds (less than 12 mph [20 km/h])
- When the outside temperature has changed suddenly (at the entrance/exit of a garage, tunnel, etc.)

امداد خودرو فارما

تلفن شبانه روزی: ۰۲۱-۸۸۸۶۲۰۸۵

FarmaSOS.com

3-7. Other interior features Ashtrays

► Front

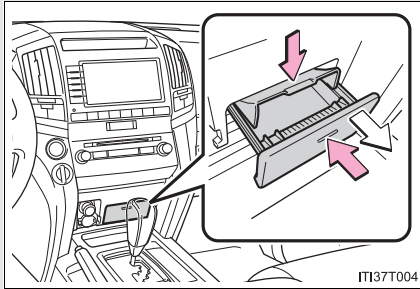

Press in and release the lid to open.

Press down on the lock spring plate to remove.

Press the lid to close.

► Rear

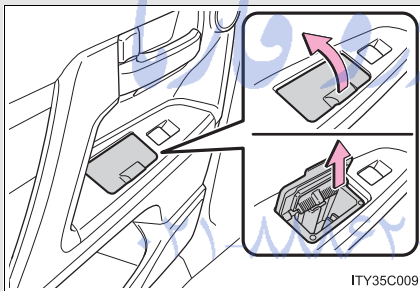

Pull the ashtray lid to open.

Pull the ashtray upwards to remove.

FarmaSOS.com

 CAUTION

■ **When not in use**

Keep the ashtray closed.

Injuries may result in the event of sudden braking, sudden swerving or an accident.

■ **To prevent fire**

- Fully extinguish matches and cigarettes before putting them in the ashtray, then make sure the ashtray is fully closed.
- Do not place paper or any other type of flammable object in the ashtray.

امداد خودرو فارما

تلفن شبانه روزی: ۰۲۱-۸۸۶۲۰۸۵

FarmaSOS.com

3-7. Other interior features

Cigarette lighter

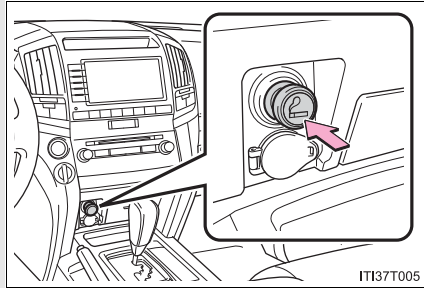

Push the cigarette lighter in.

The cigarette lighter will pop up when ready for use.

■ The cigarette lighter can be used when

The "ENGINE START STOP" switch is in ACCESSORY or IGNITION ON mode.

⚠ CAUTION

■ To avoid burns or fires

- Do not touch the metal parts of the cigarette lighter.
- Do not hold the cigarette lighter down. It could overheat and cause a fire.
- Do not insert anything other than the cigarette lighter into the outlet.

3-7. Other interior features

Power outlets

The power outlets can be used for a following component.

12 V: Accessories that run on less than 10 A

120 V AC: Accessories that use less than 100 W

► Front (12V)

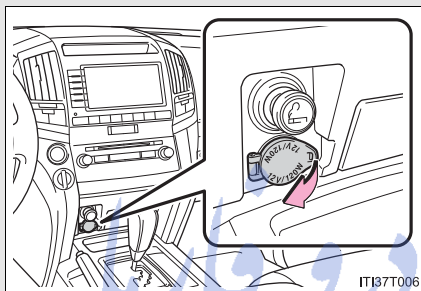

► Rear (12V)

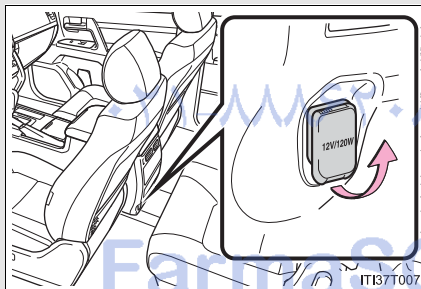

► Luggage compartment (120V AC)

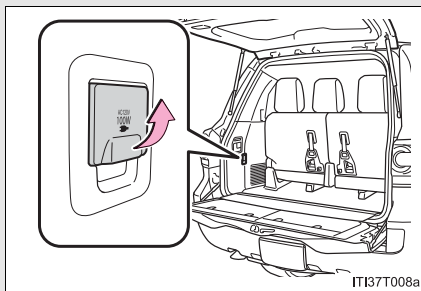

■ **The power outlets can be used when**

12V: The “ENGINE START STOP” switch is in ACCESSORY or IGNITION ON mode.

120V: The “ENGINE START STOP” switch is in IGNITION ON mode.

■ **When using the instrument panel power outlet**

You may be unable to use the USB port if a device is connected to the instrument panel power outlet at the same time.

 **NOTICE**

■ **To avoid damaging the power outlets**

Close the power outlet lid when not in use.

Foreign objects or liquids that enter the power outlet may cause a short circuit.

■ **To prevent the fuse from being blown**

12V: Do not use an accessory that uses more than 12V/10A.

120V: Do not use a 120V AC appliance that requires more than 100W.

If a 120V AC appliance that consumes more than 100W is used, the protection circuit will cut the power supply.

■ **To prevent the battery from being discharged**

Do not use the power outlet longer than necessary when the engine is not running.

■ **Appliances that may not operate properly (120V AC)**

The following 120V AC appliances may not operate even if their power consumption is under 100W.

- Appliances with high initial peak wattage
- Measuring devices that process precise data
- Other appliances that require an extremely stable power supply

3-7. Other interior features Heated steering wheel*

The heated steering wheel can be used to heat the leather portion of the steering wheel.

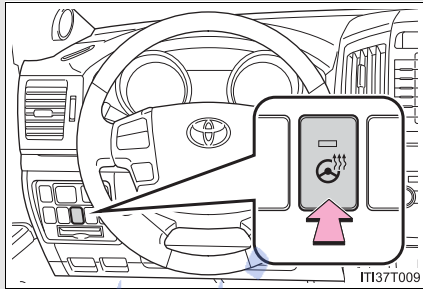

On/Off

The indicator light comes on when the heater is operating.

■ The heated steering wheel can be used when

The "ENGINE START STOP" switch is in IGNITION ON mode.

■ Timer

The heated steering wheel will automatically turn off after about 30 minutes.

■ If the indicator light flashes

Press the switch to turn the heated steering wheel off and then press the switch again. If the indicator light still flashes, a malfunction may be occurring. Turn the heated steering wheel off and have the vehicle inspected by your Toyota dealer.

3-7. Other interior features

CAUTION

■ Burns

- Only appropriately qualified and capable non-impaired persons should operate the vehicle. However, care should be taken to prevent injury if anyone in the following categories comes into contact with the steering wheel when the heated steering wheel is on:
 - Babies, small children, the elderly, the sick and the disabled
 - Persons with sensitive skin
 - Persons who are fatigued
 - Persons who have taken alcohol or drugs that induce sleep (sleeping drugs, cold remedies, etc.)
- Do not use the heated steering wheel more than necessary. Doing so may cause minor burns or overheating.

NOTICE

■ To prevent battery discharge

Turn the switch off when the engine is not running.

FarmaSOS.com

3-7. Other interior features

Seat heaters and ventilators

The seat heaters and ventilators heat the seats and maintain good airflow by blowing air from the seats.

■ Front seat heaters/ventilators

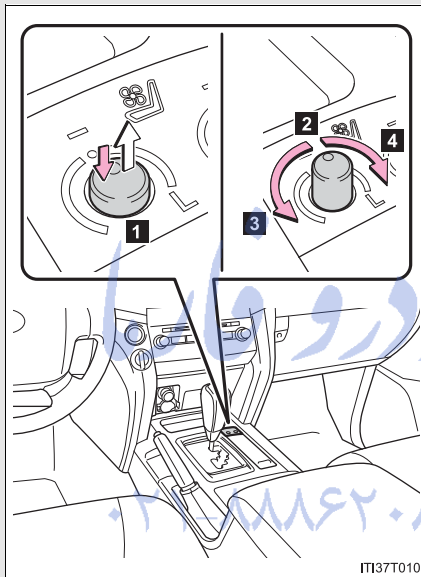

- 1 Press the knob to release it.

Press the knob back in when finished adjusting the temperature or the seat air flow.

- 2 Off
- 3 Blows air from the seat

The indicator light comes on. The further you turn the knob counterclockwise, the stronger the airflow becomes.

- 4 Turns the seat heater on

The indicator light comes on. The further you turn the knob clockwise, the warmer the seat becomes.

■ Second seat heaters (if equipped)

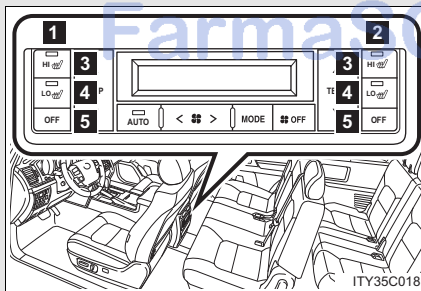

- 1 For left second seat
- 2 For right second seat
- 3 High heating temperature
- 4 Low heating temperature
- 5 Off

To turn on the seat heater, press "HI" or "LO". To turn off, press "OFF".

The indicator light on "HI" or "LO" switch indicates that the seat heater is on.

■ **The seat heaters and ventilators can be used when**

The “ENGINE START STOP” switch is in IGNITION ON mode.

■ **Replacing the air filters**

Filters are installed in the seat ventilators. For replacement of the filters, contact your Toyota dealer.

 **CAUTION**

■ **Burns**

- Use caution when seating the following persons in a seat with the seat heater on to avoid the possibility of burns:
 - Babies, small children, the elderly, the sick and the physically challenged
 - Persons with sensitive skin
 - Persons who are fatigued
 - Persons who have taken alcohol or drugs that induce sleep (sleeping drugs, cold remedies, etc.)
- Do not cover the seat with anything when using the seat heater. Using the seat heater with a blanket or cushion increases the temperature of the seat and may lead to overheating.
- Do not use the seat heater more than necessary. Doing so may cause minor burns or overheating.

 **NOTICE**

■ **To prevent damage to the seat heaters and ventilators**

Do not put heavy objects that have an uneven surface on the seat and do not stick sharp objects (needles, nails, etc.) into the seat.

■ **To prevent battery discharge**

Turn the seat heaters and ventilators off and observe that the indicator light is off when the engine is not running.

3-7. Other interior features Armrest

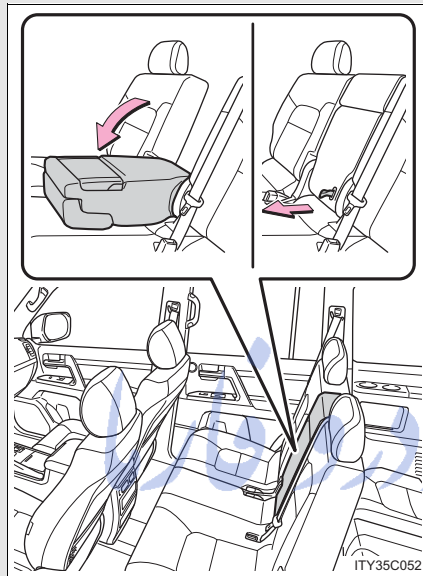

Fold down the armrest while pulling the strap.

3

Interior features

 **NOTICE**

■ To prevent damage to the armrest

Do not place too much strain on the armrest.

3-7. Other interior features

Assist grips

An assist grip (Type A) installed on the ceiling can be used to support your body while sitting on the seat.

An assist grip (Type B) installed on the pillar can be used when getting in or out of the vehicle and others.

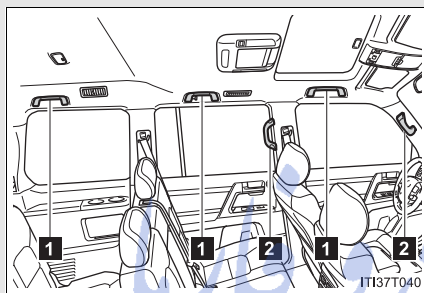

1 Assist grip (Type A)

2 Assist grip (Type B)

CAUTION

■ Assist grip (Type A)

Do not use the assist grip (Type A) when getting in or out of the vehicle or rising from your seat.

NOTICE

■ To prevent damage of the assist grip

Do not hang any heavy object or put a heavy load on the assist grip.

3-7. Other interior features

Floor mats

Use only floor mats designed specifically for vehicles of the same model and model year as your vehicle. Fix them securely in place onto the carpet.

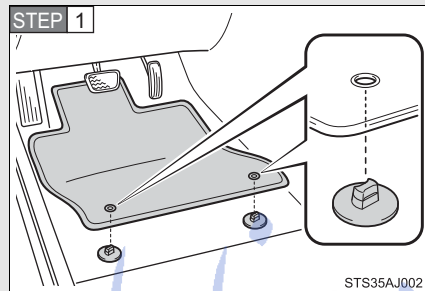

Insert the retaining hooks (clips) into the floor mat eyelets.

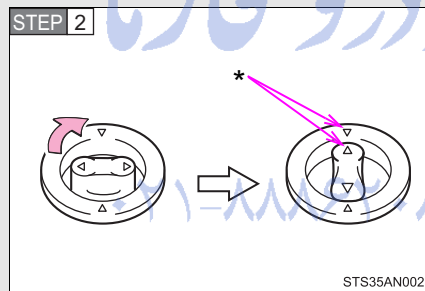

Turn the upper knob of each retaining hook (clip) to secure the floor mats in place.

*: Always align the \triangle marks.

The shape of the retaining hooks (clips) may differ from that shown in the illustration.

⚠ CAUTION

Observe the following precautions.

Failure to do so may cause the driver's floor mat to slip, possibly interfering with the pedals while driving. An unexpectedly high speed may result or it may become difficult to stop the vehicle, leading to a serious accident.

■ **When installing the driver's floor mat**

- Do not use floor mats designed for other models or different model year vehicles, even if they are Toyota Genuine floor mats.
- Only use floor mats designed for the driver's seat.
- Always install the floor mat securely using the retaining hooks (clips) provided.
- Do not use two or more floor mats on top of each other.
- Do not place the floor mat bottom-side up or upside-down.

■ **Before driving**

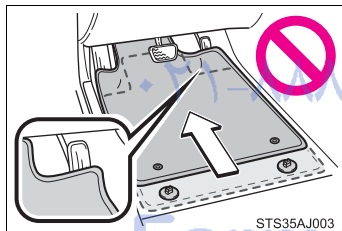

- Check that the floor mat is securely fixed in the correct place with all the provided retaining hooks (clips). Be especially careful to perform this check after cleaning the floor.
- With the engine stopped and the shift lever in "P", fully depress each pedal to the floor to make sure it does not interfere with the floor mat.

3-7. Other interior features

Luggage compartment features

■ Cargo hooks

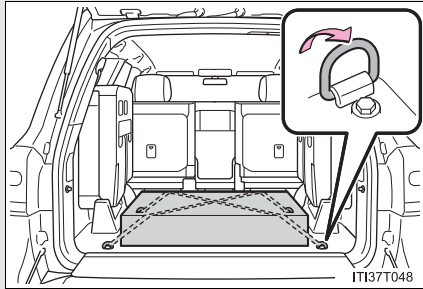

Cargo hooks are provided for securing loose items.

■ Cargo net hooks

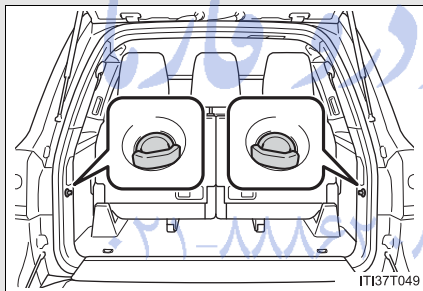

To hang the cargo net, use the cargo net hooks and rear tie-down hooks.

The cargo net itself is not included as an original equipment.

تلفن شبانه روزی: ۰۲۱-۸۸۸۳۱۱۵

3

Interior features

FarmaSOS.com

3-7. Other interior features

■ Warning reflector holder

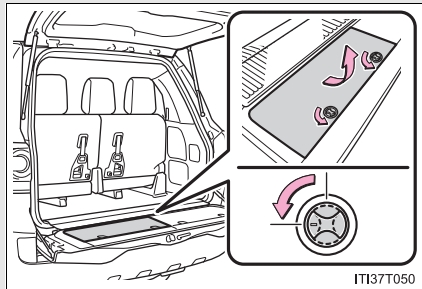

Remove the cover. Hold the warning reflector with the bands.

The warning reflector itself is not included as an original equipment.

■ First-aid kit holder

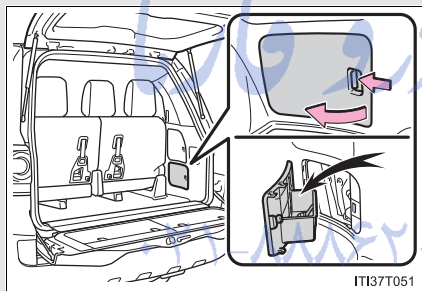

Remove the cover. Hold the first-aid kit with a band.

The first-aid kit itself is not included as an original equipment.

⚠ CAUTION

■ When the cargo hooks are not in use

To avoid injury, always return the cargo hooks to their positions when they are not in use.

⚠ NOTICE

■ To prevent damage to the cargo net hooks

Avoid hanging things other than a cargo net on it.

3-7. Other interior features

Garage door opener

The garage door opener can be programmed to operate garage doors, gates, entry doors, door locks, home lighting systems, security systems, and other devices.

The garage door opener (HomeLink® Universal Transceiver) is manufactured under license from HomeLink®.

Programming HomeLink® (for U.S.A. owners)

The HomeLink® compatible transceiver in your vehicle has 3 buttons which can be programmed to operate 3 different devices. Refer to the programming method below appropriate for the device.

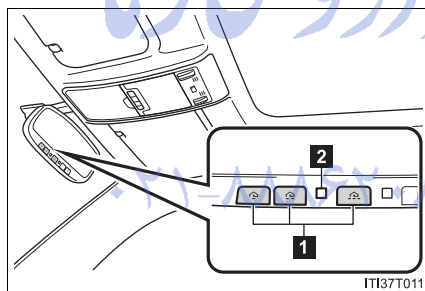

- 1 Buttons
- 2 Indicator

3

Interior features

FarmaSOS.com

■ Programming HomeLink®

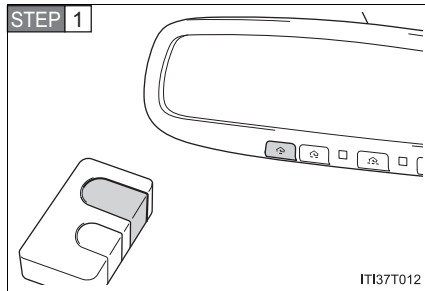

Point the remote control transmitter for the device 1 to 3 in. (25 to 75 mm) from the HomeLink® buttons.

Keep the HomeLink® indicator light in view while programming.

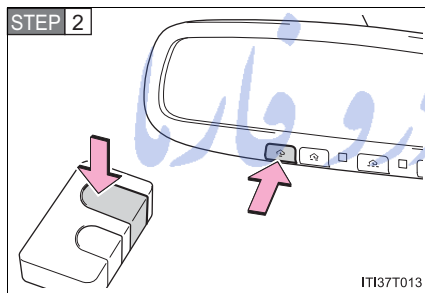

Press and hold one of the HomeLink® buttons and the transmitter button. When the HomeLink® indicator light changes from a slow to a rapid flash, you can release both buttons.

If the HomeLink® indicator light comes on but does not flash, flashes rapidly for 2 seconds and remains lit, the HomeLink® button is already programmed. Use the other buttons or follow the "Reprogramming a HomeLink® button" instructions. (→P. 502)

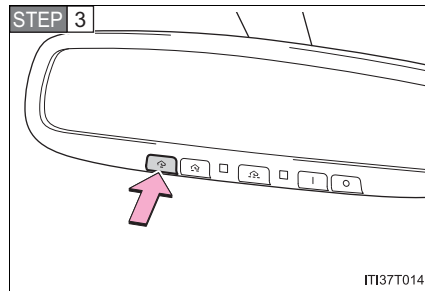

Test the HomeLink[®] operation by pressing the newly programmed button.

If a HomeLink[®] button has been programmed for a garage door, check to see if the garage door opens and closes. If the garage door does not operate, see if your remote control transmitter is of the rolling code type. Press and hold the programmed HomeLink[®] button. The remote control transmitter is of the rolling code type if the HomeLink[®] indicator light flashes rapidly for 2 seconds and then remains lit. If your transmitter is of the rolling code type, proceed to the heading "Programming a rolling code system".

STEP 4 Repeat the steps above to program another device for each of the remaining HomeLink[®] buttons.

FarmaSOS.com

■ Programming a rolling code system

If your device is rolling code equipped, follow the steps under the heading “Programming HomeLink®” before proceeding with the steps listed below.

STEP 1 Locate the learn button on the ceiling mounted garage door opener motor. The exact location and color of the button may vary by brand of garage door opener motor.

Refer to the operation manual supplied with the garage door opener motor for the location of the learn button.

STEP 2 Press the learn button.

Following this step, you have 30 seconds in which to initiate step 3 below.

STEP 3 Press and hold the vehicle’s programmed HomeLink® button for 2 seconds and release it. Repeat this step once again. The garage door may open.

If the garage door opens, the programming process is complete. If the door does not open, press and release the button a third time. This third press and release will complete the programming process by opening the garage door.

The ceiling mounted garage door opener motor should now recognize the HomeLink® signal and operate the garage door.

STEP 4 Repeat the steps above to program another rolling code system for any of the remaining HomeLink® buttons.

■ Programming an entry gate (for U.S.A. owners)/Programming all devices in the Canadian market

STEP 1 Place your transmitter 1 to 3 in. (25 to 75 mm) away from the surface of the HomeLink®.

Keep the HomeLink® indicator light in view while programming.

STEP 2 Press and hold the selected HomeLink® button.

STEP 3 Repeatedly press and release (cycle) the device's remote control button for two seconds each until step 4 is completed.

STEP 4 When the indicator light on the HomeLink® compatible transceiver starts to flash rapidly, release the buttons.

STEP 5 Test the operation of the HomeLink® by pressing the newly programmed button. Check to see if the gate/device operates correctly.

STEP 6 Repeat the steps above to program another device for each of the remaining HomeLink® buttons.

■ Programming other devices

To program other devices such as home security systems, home door locks or lighting, contact your authorized Toyota dealer for assistance.

■ Reprogramming a button

The individual HomeLink® buttons cannot be erased but can be reprogrammed. To reprogram a button, follow the "Reprogramming a HomeLink® button" instructions.

3-7. Other interior features

Operating HomeLink®

Press the appropriate HomeLink® button. The HomeLink® indicator light should come on.

The HomeLink® compatible transceiver in your vehicle continues to send a signal for up to 20 seconds as long as the button is pressed.

Reprogramming a HomeLink® button

Press and hold the desired HomeLink® button. After 20 seconds, the HomeLink® indicator light will start flashing slowly. Next, while still pressing and holding the HomeLink® button, press and hold the button on the transmitter until the HomeLink® indicator light changes from a slow to a rapid flash.

Erasing the entire HomeLink® memory (all three programs)

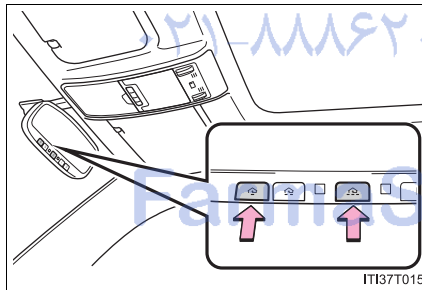

Press and hold the 2 outside buttons for 10 seconds until the indicator light flashes.

If you sell your vehicle, be sure to erase the programs stored in the HomeLink® memory.

■ Before programming

- Install a new battery in the remote control transmitter.
- The battery side of the remote control transmitter must be pointed away from the HomeLink® button.

■ Certification for the garage door opener

FCC ID:NZLOBIHL4

FCC ID:NZLWZLHL4

NOTE:

This device complies with Part 15 of the FCC Rules. Operation is subject to the following two conditions: (1) this device may not cause harmful interference, and (2) this device must accept any interference received, including interference that may cause undesired operation.

FCC WARNING:

Changes or modifications not expressly approved by the party responsible for compliance could void the user's authority to operate the equipment.

■ When support is necessary

Visit on the web at www.homelink.com or call 1-800-355-3515.

⚠ CAUTION

■ When programming a garage door or other remote control devices

The garage door or other devices may operate, so ensure people and objects are out of danger to prevent potential harm.

■ Conforming to federal safety standards

Do not use the HomeLink® compatible transceiver with any garage door opener or device that lacks safety stop and reverse features as required by federal safety standards.

This includes any garage door that cannot detect an interfering object. A door or device without these features increases the risk of death or serious injury.

3-7. Other interior features

Safety Connect*

Safety Connect is a subscription-based telematics service that uses Global Positioning System (GPS) data and embedded cellular technology to provide safety and security features to subscribers. Safety Connect is supported by Toyota's designated response center, which operates 24 hours per day, 7 days per week.

Safety Connect service is available by subscription on select, telematics hardware-equipped vehicles.

By using the Safety Connect service, you are agreeing to be bound by the Telematics Subscription Service Agreement and its Terms and Conditions, as in effect and amended from time to time, a current copy of which is available at Toyota.com. All use of the Safety Connect service is subject to such then-applicable Terms and Conditions.

■ System components

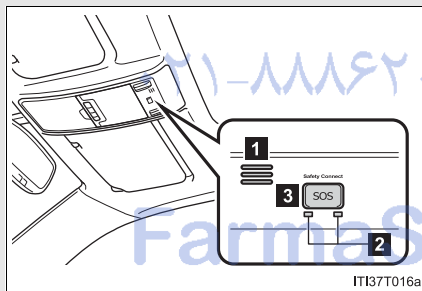

- 1 Microphone
- 2 LED light indicators
- 3 "SOS" button

*: If equipped

■ **Services**

Subscribers have the following Safety Connect services available:

- **Automatic Collision Notification***
Helps drivers receive necessary response from emergency service providers. (→P. 507)
*: U.S. Patent No. 7,508,298 B2
- **Stolen Vehicle Location**
Helps drivers in the event of vehicle theft. (→P. 508)
- **Emergency Assistance Button (SOS)**
Connects drivers to response-center support. (→P. 508)
- **Roadside Assistance**
Provides drivers various on-road assistance. (→P. 508)

■ **Subscription**

After you have signed the Telematics Subscription Service Agreement and are enrolled, you can begin receiving services. A variety of subscription terms is available for purchase. Contact your Toyota dealer, call 1-800-331-4331, or push the “SOS” button in your vehicle for further subscription details.

■ **Safety Connect Services Information**

- Phone calls using the vehicles Bluetooth® technology will not be possible during Safety Connect.
- Safety Connect is available beginning Fall 2009 on select Toyota models. Contact with the Safety Connect response center is dependent upon the telematics device being in operative condition, cellular connection availability, and GPS satellite signal reception, which can limit the ability to reach the response center or receive emergency service support. Enrollment and Telematics Subscription Service Agreement required. A variety of subscription terms is available; charges vary by subscription term selected.
- Automatic Collision Notification, Emergency Assistance, Stolen Vehicle Location, and Enhanced Roadside Assistance will function in the United States, including Hawaii and Alaska, and in Canada. No Safety Connect services will function outside of the United States in countries other than Canada.
- Safety Connect services are not subject to section 255 of the Telecommunications Act and the device is not TTY compatible.

■ **Languages** • ۲۱-۸۸۶۲۰۸۵ تلفن شبانه روزی

The Safety Connect response center will offer support in multiple languages. The Safety Connect system will offer voice prompts in English and Spanish. Please indicate your language of choice when enrolling.

■ **When contacting the response center**

You may be unable to contact the response center if the network is busy.

■ **Safety Connect backup battery depletion**

An exclusive backup battery is built in to assist the Automatic Collision Notification, which is activated when impact above a certain level is applied to the vehicle, or when the airbags operate. This battery is a primary battery, and cannot be recharged. The red LED indicator will flash to indicate that the battery should be replaced.

The backup battery will need to be replaced if the Automatic Collision Notification operates for 60 seconds or more. For replacement, consult your Toyota dealer.

Safety Connect LED light indicators

When the “ENGINE START STOP” switch is turned to IGNITION ON mode, the red indicator light comes on for 2 seconds then turns off. Afterward, the green indicator light comes on, indicating that the service is active.

The following indicator light patterns indicate specific system usage conditions:

- Green indicator light on = Active service
- Green indicator light flashing = Safety Connect call in process
- Red indicator light (except at vehicle start-up) = System malfunction (contact your Toyota dealer)
- No indicator light (off) = Safety Connect service not active

Safety Connect services

■ Automatic Collision Notification

In case of either airbag deployment or severe rear-end collision, the system is designed to automatically call the response center. The responding agent receives the vehicle's location and attempts to speak with the vehicle occupants to assess the level of emergency. If the occupants are unable to communicate, the agent automatically treats the call as an emergency, contacts the nearest emergency services provider to describe the situation, and requests that assistance be sent to the location.

■ **Stolen Vehicle Location**

If your vehicle is stolen, Safety Connect can work with local authorities to assist them in locating and recovering the vehicle. After filing a police report, call the Safety Connect response center at 1-800-331-4331 and follow the prompts for Safety Connect to initiate this service.

In addition to assisting law enforcement with recovery of a stolen vehicle, Safety-Connect-equipped vehicle location data may, under certain circumstances, be shared with third parties to locate your vehicle. Further information is available at Toyota.com.

■ **Emergency Assistance Button (“SOS”)**

In the event of an emergency on the road, push the “SOS” button to reach the Safety Connect response center. The answering agent will determine your vehicle’s location, assess the emergency, and dispatch the necessary assistance required.

If you accidentally press the “SOS” button, tell the response-center agent that you are not experiencing an emergency.

■ **Roadside Assistance**

Subscribers can press the “SOS” button to reach a Safety Connect response-center agent, who can help with a wide range of needs, such as: towing, flat tire, fuel delivery, etc. For a description of the Roadside Assistance services and their limitations, please see the Safety Connect Terms and Conditions, which are available at Toyota.com.

Safety information for Safety Connect

Important! Read this information before using Safety Connect.

■ Exposure to radio frequency signals

The Safety Connect system installed in your vehicle is a low-power radio transmitter and receiver. It receives and also sends out radio frequency (RF) signals.

In August 1996, the Federal Communications Commission (FCC) adopted RF exposure guidelines with safety levels for mobile wireless phones. Those guidelines are consistent with the safety standards previously set by the following U.S. and international standards bodies.

- ANSI (American National Standards Institute) C95.1 [1992]
- NCRP (National Council on Radiation Protection and Measurement) Report 86 [1986]
- ICNIRP (International Commission on Non-Ionizing Radiation Protection) [1996]

Those standards were based on comprehensive and periodic evaluations of the relevant scientific literature. Over 120 scientists, engineers, and physicians from universities, and government health agencies and industries reviewed the available body of research to develop the ANSI Standard (C95.1).

The design of Safety Connect complies with the FCC guidelines in addition to those standards.

■ **Certification for Safety Connect**

FCC ID: O9EGTM1

FCC ID: O6Y-CDMRF101

FCC ID: N7NGTM2

NOTE:

This device complies with part 15 of the FCC Rules. Operation is subject to the following two conditions: (1) This device may not cause harmful interference, and (2) this device must accept any interference received, including interference that may cause undesired operation.

FCC WARNING:

Changes or modifications not expressly approved by the party responsible for compliance could void the user's authority to operate the equipment.

امداد خودرو فارما
تلفن شبانه روزی: ۰۲۱-۸۸۸۶۲۰۸۵

FarmaSOS.com

4-1. Maintenance and care
Cleaning and protecting the vehicle exterior..... 512
Cleaning and protecting the vehicle interior..... 515

4-2. Maintenance
Maintenance requirements..... 518
General maintenance..... 521
Emission inspection and maintenance (I/M) programs..... 524

4-3. Do-it-yourself maintenance
Do-it-yourself service precautions 525
Hood 528
Engine compartment..... 529
Tires 544
Tire inflation pressure 553
Wheels 557
Air conditioning filter..... 560
Electronic key battery..... 563
Checking and replacing fuses 566
Headlight aim 580
Light bulbs..... 582

4-1. Maintenance and care

Cleaning and protecting the vehicle exterior

Perform the following to protect the vehicle and maintain it in prime condition.

- Working from top to bottom, liberally apply water to the vehicle body, wheel wells and underside of the vehicle to remove any dirt and dust.

Wash the vehicle body using a sponge or soft cloth, such as a cham-
ois.

- For hard-to-remove marks, use car wash soap and rinse thoroughly with water.
- Wipe away any water.
- Wax the vehicle when the waterproof coating deteriorates.

If water does not bead on a clean surface, apply wax when the vehicle body is cool.

تلفن شبانه روزی: ۰۲۱-۸۸۶۲۰۸۵

■ Automatic car washes

- Fold the mirrors back and retract the antenna before washing the vehicle.
- Brushes used in automatic car washes may scratch the vehicle surface and harm your vehicle's paint.
- Rear spoiler (if equipped) may not be washable in some automatic car washes. There may also be an increased risk of damage to vehicle.

■ High pressure car washes

- Do not allow the nozzles of the car wash to come within close proximity of the windows.
- Before car wash, check that the fuel filler door is closed.

■ Aluminum wheels

- Remove any dirt immediately by using a neutral detergent. Do not use hard brushes or abrasive cleaners. Do not use strong or harsh chemical cleaners. Use the same mild detergent and wax as used on the paint.
- Do not use detergent on the wheels when they are hot, for example after driving for long distance in the hot weather.
- Wash detergent from the wheels immediately after use.

■ Bumpers and side moldings

Do not scrub with abrasive cleaners.

⚠ CAUTION

■ **When cleaning the windshield (vehicles with rain-sensing windshield wiper)**

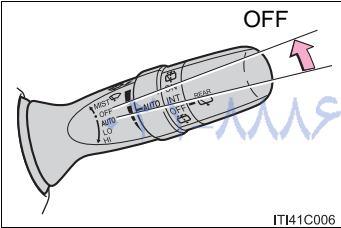

OFF

IT141C006

Set the wiper switch to off. If the wiper switch is in "AUTO", the wipers may operate unexpectedly in the following situations, and may result in hands being caught or other serious injuries and cause damage to the wiper blades.

- When the upper part of the windshield where the raindrop sensor is located is touched by hand
- When a wet rag or similar is held close to the raindrop sensor
- If something bumps against the windshield
- If you directly touch the raindrop sensor body or if something bumps into the raindrop sensor

■ **Caution about the exhaust pipe**

Exhaust gasses cause the exhaust pipe to become quite hot. When washing the vehicle, be careful not to touch the pipe until it has cooled sufficiently, as touching a hot exhaust pipe can cause burns.

 NOTICE

■ **To prevent paint deterioration and corrosion on the body and components (aluminum wheels etc.)**

- Wash the vehicle immediately in the following cases:
 - After driving near the sea coast
 - After driving on salted roads
 - If you see coal tar or tree sap on the paint surface
 - If you see dead insects or insect droppings on the paint
 - After driving in an area contaminated with soot, oily smoke, mine dust, iron powder or chemical substances
 - If the vehicle becomes heavily soiled in dust or mud
 - If liquids such as benzene and gasoline are spilled on the paint surface
- If the paint is chipped or scratched, have it repaired immediately.
- To prevent the wheels from corroding, remove any dirt and store in a place with low humidity when storing the wheels.

■ **Cleaning the exterior lights**

- Wash carefully. Do not use organic substances or scrub with a hard brush. This may damage the surfaces of the lights.
- Do not apply wax on the surface of the lights. Wax may cause damage to the lenses.

■ **When using an automatic car wash (vehicles with rain-sensing windshield wipers)**

Turn off the wiper switch.
If the wiper switch is in "AUTO", the wipers may operate and the wiper blades may be damaged.

4-1. Maintenance and care

Cleaning and protecting the vehicle interior

The following procedures will help protect your vehicle's interior and keep it in top condition:

■ **Protecting the vehicle interior**

Remove dirt and dust using a vacuum cleaner. Wipe dirty surfaces with a cloth dampened with lukewarm water.

■ **Cleaning the leather areas**

- Remove dirt and dust using a vacuum cleaner.
- Wipe any excess dirt and dust with a soft cloth dampened with diluted detergent.

Use a diluted water solution of approximately 5% neutral wool detergent.

- Wring out any excess water from the cloth and thoroughly wipe off all remaining traces of detergent.
- Wipe the surface with a dry, soft cloth to remove any remaining moisture. Allow the leather to dry in shaded and ventilated area.

■ **Synthetic leather areas**

- Remove loose dirt using a vacuum cleaner.
- Apply a mild soap solution to the synthetic leather using a sponge or soft cloth.
- Allow the solution to soak in for a few minutes. Remove the dirt and wipe off the solution with a clean, damp cloth.

■ Caring for leather areas

Toyota recommends cleaning the interior of the vehicle at least twice a year to maintain the quality of the vehicle's interior.

■ Shampooing the carpets

There are several commercial foaming-type cleaners available. Use a sponge or brush to apply the foam. Rub in overlapping circles. Do not apply water. Excellent results are obtained by keeping the carpet as dry as possible.

■ Seat belts

Clean with mild soap and lukewarm water using a cloth or sponge. Also check the belts periodically for excessive wear, fraying or cuts.

⚠ CAUTION

■ Water in the vehicle

- Do not splash or spill liquid in the vehicle.
Doing so may cause electrical components etc. to malfunction or catch fire.
- Do not get any of the SRS components or wiring in the vehicle interior wet. (→P. 115)
Electrical malfunction may cause the airbags to deploy or not function properly, resulting in death or serious injury.

■ Cleaning the interior (especially instrument panel)

Do not use polish wax or polish cleaner. The instrument panel may reflect off the windshield, obstructing the driver's view and leading to an accident, resulting in death or serious injury.

 NOTICE

■ Cleaning detergents

- Do not use the following types of detergent, as they may discolor the vehicle interior or cause streaks or damage to painted surfaces.
 - Non-seat portions: Organic substances such as benzene or gasoline, alkaline or acidic solutions, dye, or bleach.
 - Seats: Acidic solutions, such as thinner, benzene, or alcohol.
- Do not use polish wax or polish cleaner. The instrument panel's or other interior part's painted surface may be damaged.

■ Preventing damage to leather surfaces

Observe the following precautions to avoid damage to and deterioration of leather surfaces.

- Remove any dust or dirt on leather surfaces immediately.
- Do not expose the vehicle to direct sunlight for extended periods of time. Park the vehicle in the shade, especially during summer.
- Do not place items made of vinyl, plastic, or that contain wax on the upholstery, as they may stick to the leather surface if the vehicle interior heats up significantly.

■ Water on the floor

Do not wash the vehicle floor with water.

Vehicle systems such as the audio system may be damaged if water comes into contact with electrical components under the floor of the vehicle, and may also cause the body to rust.

■ Cleaning the inside of the rear window

- Do not use glass cleaner to clean the rear quarter windows and rear window, as this may cause damage to the antenna or rear window defogger heater wires. Use a cloth dampened with lukewarm water to gently wipe the window clean. Wipe the window in strokes running parallel to the heater wires or antenna.
- Be careful not to scratch or damage the heater wires or antenna.

4-2. Maintenance

Maintenance requirements

To ensure safe and economical driving, day-to-day care and regular maintenance is essential. Toyota recommends the following maintenance.

■ General maintenance

General maintenance should be performed on a daily basis. This can be done by yourself or by a Toyota dealer.

■ Scheduled maintenance

Scheduled maintenance should be performed at specified intervals according to the maintenance schedule.

For details about maintenance items and schedules, refer to the "Scheduled Maintenance Guide" or "Owner's Manual Supplement".

■ Do-it-yourself maintenance

You can perform some maintenance procedures yourself. Please be aware that do-it-yourself maintenance may affect warranty coverage.

The use of Toyota Repair Manuals is recommended.

For details about warranty coverage, see the "Owner's Warranty Information Booklet" or "Owner's Manual Supplement".

■ Repair and replacement

It is recommended that genuine Toyota parts be used for repair to ensure performance of each system. If non-Toyota parts are used in replacement or if a repair shop other than a Toyota dealer performs repairs, confirm the warranty coverage.

■ Reset the maintenance data

After the required maintenance is performed according to the maintenance schedule, please reset the maintenance data.

To reset the data, follow the procedures described below:

STEP 1 Switch the display to the trip meter A when the engine is running.
(→P. 180)

STEP 2 Turn the “ENGINE START STOP” switch OFF.

STEP 3 While pressing the trip meter reset button, set the “ENGINE START STOP” switch to IGNITION ON mode (but do not start the engine because otherwise the reset mode will be canceled). Continue to press and hold the button until the multi-information display indicates that the reset is complete.

■ Allow inspection and repairs to be performed by a Toyota dealer

- Toyota technicians are well-trained specialists and are kept up to date with the latest service information. They are well informed about the operations of all systems on your vehicle.
- Keep a copy of the repair order. It proves that the maintenance that has been performed is under warranty coverage. If any problem should arise while your vehicle is under warranty, your Toyota dealer will promptly take care of it.

 CAUTION

■ **If your vehicle is not properly maintained**

Improper maintenance could result in serious damage to the vehicle and possible death or serious injury.

■ **Handling of the battery**

- Engine exhaust, some of its constituents, and a wide variety of automobile components contain or emit chemicals known to the State of California to cause cancer and birth defects and other reproductive harm. Work in a well ventilated area.
- Oils, fuels and fluids contained in vehicles as well as waste produced by component wear contain or emit chemicals known to the State of California to cause cancer and birth defects or other reproductive harm. Avoid exposure and wash any affected area immediately.
- Battery posts, terminals and related accessories contain lead and lead compounds which are known to cause brain damage. Wash your hands after handling. (→P. 540)

تلفن شبانه روزی: ۰۲۱-۸۸۸۶۲۰۸۵

FarmaSOS.com

4-2. Maintenance

General maintenance

Listed below are the general maintenance items that should be performed at the intervals specified in the “Owner’s Warranty Information Booklet” or “Owner’s Manual Supplement”/Scheduled Maintenance Guide. It is recommended that any problem you notice should be brought to the attention of your Toyota dealer or qualified service shop for advice.

Engine compartment

Items	Check points
Battery	• Maintenance-free (→P. 540)
Brake fluid	• At the correct level? (→P. 537)
Engine coolant	• At the correct level? (→P. 535)
Engine oil	• At the correct level? (→P. 531)
Exhaust system	• No fumes or strange sounds?
Power steering fluid	• At the correct level? تلف (→P. 539)
Radiator/condenser/hoses	• Not blocked with foreign matter? (→P. 536)
Washer fluid	• At the correct level? (→P. 543)

4-2. Maintenance

Vehicle interior

Items	Check points
Accelerator pedal	<ul style="list-style-type: none"> Moves smoothly (without uneven pedal effort or catching)?
Automatic transmission "Park" mechanism	<ul style="list-style-type: none"> Can the vehicle be hold securely on an incline with the shift lever in "P"?
Brake pedal	<ul style="list-style-type: none"> Moves smoothly? Does it have appropriate clearance and correct amount of free play?
Brakes	<ul style="list-style-type: none"> Pulls to one side when applied? Loss of brake effectiveness? Spongy feeling brake pedal? Pedal almost touches floor?
Head restraints	<ul style="list-style-type: none"> Move smoothly and lock securely?
Indicators/buzzers	<ul style="list-style-type: none"> Function properly?
Lights	<ul style="list-style-type: none"> Do all the lights come on? Headlights aimed correctly?
Parking brake	<ul style="list-style-type: none"> Moves smoothly? Can hold the vehicle securely on an incline?
Seat belts	<ul style="list-style-type: none"> Does the seat belt system operate smoothly? Are the belts undamaged?
Seats	<ul style="list-style-type: none"> Do the seat controls operate properly?
Steering wheel	<ul style="list-style-type: none"> Moves smoothly? Has correct free play? No strange noises?

Vehicle exterior

Items	Check points
Doors	<ul style="list-style-type: none"> • Operate smoothly?
Engine hood	<ul style="list-style-type: none"> • The lock system works properly?
Fluid leaks	<ul style="list-style-type: none"> • Is there any leakage after parking?
Tire	<ul style="list-style-type: none"> • Inflation pressure is correct? • Tire surfaces not worn or damaged? • Tires rotated according to the maintenance schedule? • Wheel nuts are not loose?
Windshield wipers/rear window wiper	<ul style="list-style-type: none"> • The wiper blades should not show any signs of cracking, splitting, wear, contamination or deformation. • The wiper blades should clear the windshield/rear window without streaking or skipping.

⚠ CAUTION**■ If the engine is running**

Turn off the engine and ensure that there is adequate ventilation before performing maintenance checks.

Some states have vehicle emission inspection programs which include OBD (On Board Diagnostics) checks. The OBD system monitors the operation of the emission control system.

■ **If the malfunction indicator lamp comes on**

The OBD system determines that a problem exists somewhere in the emission control system. Your vehicle may not pass the I/M test and may need to be repaired. Contact your Toyota dealer to service the vehicle.

■ **Your vehicle may not pass the I/M test:**

- When the battery is disconnected or discharged

Readiness codes that are set during ordinary driving are erased.

Also, depending on your driving habits, the readiness codes may not be completely set.

- When the fuel tank cap is loose

The malfunction indicator lamp comes on as a temporary malfunction and your vehicle may not pass the I/M test.

■ **When the malfunction indicator lamp goes off after several driving trips**

The error code in the OBD system will not be cleared unless the vehicle is driven 40 or more times.

■ **If your vehicle does not pass the I/M test**

Contact your Toyota dealer to prepare the vehicle for re-testing.

4-3. Do-it-yourself maintenance

Do-it-yourself service precautions

If you perform maintenance yourself, be sure to follow the correct procedure given in these sections.

Items	Parts and tools
Battery condition (→P. 540)	<ul style="list-style-type: none"> • Warm water • Baking soda • Grease • Conventional wrench (for terminal clamp bolts)
Brake fluid level (→P. 537)	<ul style="list-style-type: none"> • FMVSS No.116 DOT 3 or SAE J1703 brake fluid • Rag or paper towel • Funnel (used only for adding brake fluid)
Engine coolant level (→P. 535)	<ul style="list-style-type: none"> • "Toyota Super Long Life Coolant" or similar high quality ethylene glycol based non-silicate, non-amine, non-nitrite and non-borate coolant with long-life hybrid organic acid technology. • "Toyota Super Long Life Coolant" is pre-mixed with 50% coolant and 50% deionized water. • Funnel (used only for adding coolant)
Engine oil level (→P. 531)	<ul style="list-style-type: none"> • "Toyota Genuine Motor Oil" or equivalent • Rag or paper towel • Funnel (used only for adding engine oil)
Fuses (→P. 566)	<ul style="list-style-type: none"> • Fuse with same amperage rating as original

4-3. Do-it-yourself maintenance

Items	Parts and tools
Headlight aim (→P. 580)	<ul style="list-style-type: none"> • Phillips-head screwdriver
Light bulbs (→P. 582)	<ul style="list-style-type: none"> • Bulb with same number and wattage rating as original • Phillips-head screwdriver • Flathead screwdriver • Wrench
Power steering fluid (→P. 539)	<ul style="list-style-type: none"> • Automatic transmission fluid DEXRON®II or III • Rag or paper towel • Funnel (used only for adding power steering fluid)
Radiator and condenser (→P. 536)	—
Tire inflation pressure (→P. 553)	<ul style="list-style-type: none"> • Tire pressure gauge • Compressed air source
Washer fluid (→P. 543)	<ul style="list-style-type: none"> • Water or washer fluid containing antifreeze (for winter use) • Funnel (used only for adding washer fluid)

FarmaSOS.com

⚠ CAUTION

The engine compartment contains many mechanisms and fluids that may move suddenly, become hot, or become electrically energized. To avoid death or serious injury.

■ When working on the engine compartment

- Keep hands, clothing and tools away from the moving fan and engine drive belt.
- Be careful not to touch the engine, inverter, radiator, exhaust manifold, etc. right after driving as they may be hot. Oil and other fluids may also be hot.
- Do not leave anything that may burn easily, such as paper or rags, in the engine compartment.
- Do not smoke, cause sparks or expose an open flame to fuel or the battery. Fuel and battery fumes are flammable.
- Be extremely cautious when working on the battery. It contains poisonous and corrosive sulfuric acid.

■ When working near the electric cooling fan or radiator grille

Be sure the “ENGINE START STOP” switch is OFF.
With the “ENGINE START STOP” switch in IGNITION ON mode, the electric cooling fan may automatically start to run if the air conditioning is on and/or if the coolant temperature is high. (→P. 536)

■ When working on or under the vehicle

- Do not get under the vehicle with just the jack supporting it. Always use automotive jack stands or other solid supports.
- Use eye protection to prevent flying or falling material, fluid spray, etc. from getting in your eyes.

⚠ NOTICE**■ If you remove the air cleaner filter**

Driving with the air cleaner filter removed may cause excessive engine wear due to dirt in the air.

4-3. Do-it-yourself maintenance Hood

Release the lock from the inside of the vehicle to open the hood.

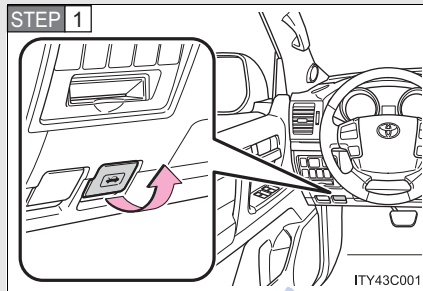

Pull the hood release lever.
The hood will pop up slightly.

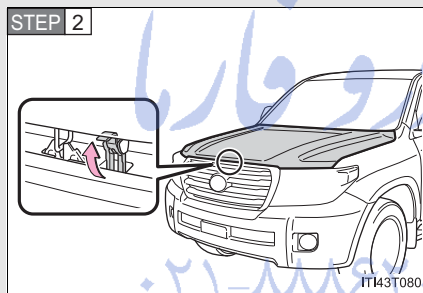

Lift the hood catch and lift the hood.

⚠ CAUTION

■ Pre-driving check

Check that the hood is fully closed and locked.
If the hood is not locked properly it may open while the vehicle is in motion and cause an accident, which may result in death or serious injury.

4-3. Do-it-yourself maintenance Engine compartment

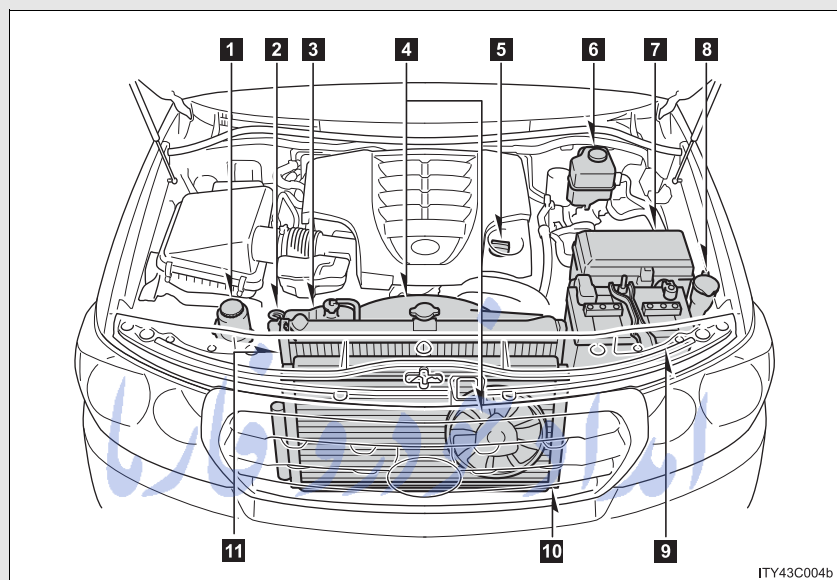

- | | |
|---------------------------------------------------|------------------------------------------|
| 1 Power steering fluid reservoir (→P. 539) | 6 Brake fluid reservoir (→P. 537) |
| 2 Engine oil level dipstick (→P. 531) | 7 Fuse box (→P. 566) |
| 3 Engine coolant reservoir (→P. 543) | 8 Washer fluid tank (→P. 543) |
| 4 Cooling fans (→P. 535) | 9 Battery (→P. 540) |
| 5 Engine oil filler cap (→P. 532) | 10 Condenser (→P. 536) |
| | 11 Radiator (→P. 536) |

4

Maintenance and care

Engine compartment cover

■ Removing the engine compartment cover

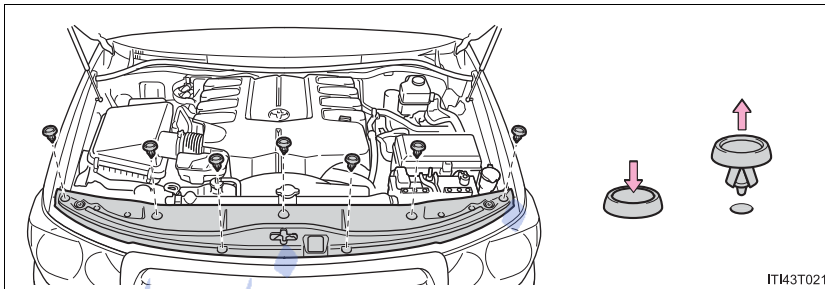

■ Installing the clips

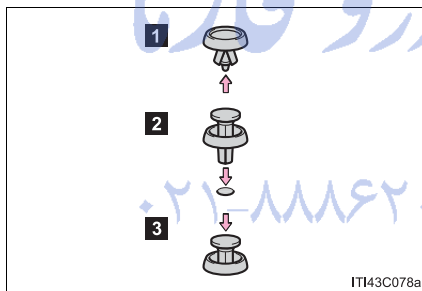

1 Push up center portion

2 Insert

3 Press

⚠ NOTICE

■ After installing an engine compartment cover

Make sure that the cover is securely installed in its original position.

Engine oil

With the engine at operating temperature and turned off, check the oil level on the dipstick.

■ Checking the engine oil

STEP 1 Park the vehicle on level ground. After warming up the engine and turning it off, wait more than 5 minutes for the oil to drain back into the bottom of the engine.

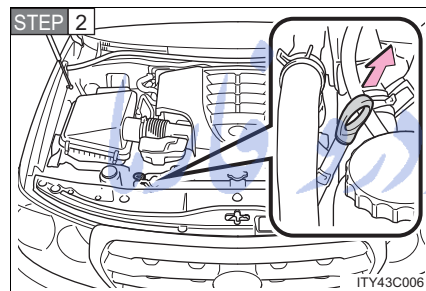

Hold a rag under the end and pull the dipstick out.

STEP 3 Wipe the dipstick clean.

STEP 4 Reinsert the dipstick fully.

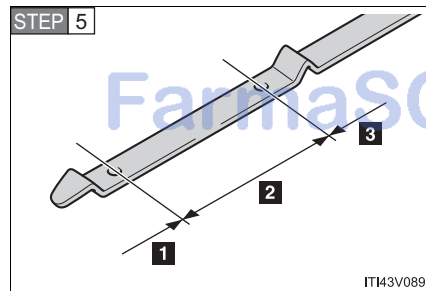

Holding a rag under the end, pull the dipstick out and check the oil level.

- 1** Low
- 2** Normal
- 3** Excessive

The shape of the dipstick may differ depending on the type of vehicle or engine.

STEP 6 Wipe the dipstick and reinsert it fully.

4-3. Do-it-yourself maintenance

■ Adding engine oil

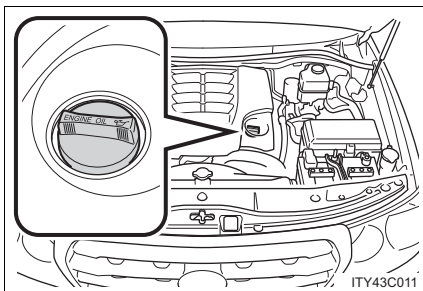

If the oil level is below or near the low level mark, add engine oil of the same type as already in the engine. (→P. 671)

Make sure to check the oil type and prepare the items needed before adding oil.

Engine oil selection	→P. 671
Oil quantity (Low → Full)	1.6 qt. (1.5 L, 1.3 Imp.qt.)
Items	Clean funnel

STEP 1 Remove the oil filler cap.

STEP 2 Add engine oil slowly, checking the dipstick.

STEP 3 Install the filler cap, turning it clockwise.

FarmaSOS.com

■ Engine oil consumption

A certain amount of engine oil will be consumed while driving. In the following situations, oil consumption may increase, and engine oil may need to be refilled in between oil maintenance intervals.

- When the engine is new, for example directly after purchasing the vehicle or after replacing the engine
- If low quality oil or oil of an inappropriate viscosity is used
- When driving at high engine speeds or with a heavy load, when towing, or when driving while accelerating or decelerating frequently
- When leaving the engine idling for a long time, or when driving frequently through heavy traffic

امداد خودرو فارما

تلفن شبانه روزی: ۰۲۱-۸۸۸۶۲۰۸۵

FarmaSOS.com

4-3. Do-it-yourself maintenance

CAUTION

■ Used engine oil

- Used engine oil contains potentially harmful contaminants which may cause skin disorders such as inflammation or skin cancer, so care should be taken to avoid prolonged and repeated contact. To remove used engine oil from your skin, wash thoroughly with soap and water.
- Dispose of used oil and filters only in a safe and acceptable manner. Do not dispose of used oil and filters in household trash, in sewers or onto the ground.
Call your Toyota dealer, service station or auto parts store for information concerning recycling or disposal.
- Do not leave used engine oil within the reach of children.

NOTICE

■ To prevent serious engine damage

Check the oil level on regular basis.

■ When replacing the engine oil

- Be careful not to spill engine oil on the vehicle components.
- Avoid overfilling, or the engine could be damaged.
- Check the oil level on the dipstick every time you refill the vehicle.
- Be sure the engine oil filler cap is properly retightened.

Engine coolant

The coolant level is satisfactory if it is between the “F” and “L” lines on the reservoir when the engine is cold.

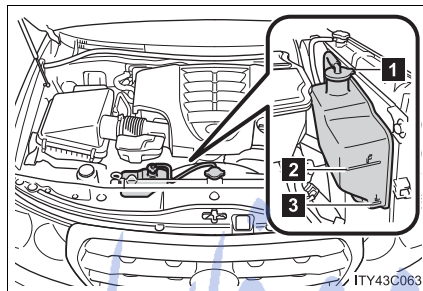

1 Reservoir cap

2 “F”

3 “L”

If the level is on or below the “L” line, add coolant up to the “F” line.

■ If the coolant level drops within a short time after replenishing

Visually check the radiator, hoses, reservoir cap, radiator cap, drain cock and water pump.

If you cannot find a leak, have your Toyota dealer pressure test the cap and check for leaks in the cooling system.

■ Coolant selection

Only use “Toyota Super Long Life Coolant” or similar high quality ethylene glycol based non-silicate, non-amine, non-nitrite, and non-borate coolant with long-life hybrid organic acid technology.

“Toyota Super Long Life Coolant” is a mixture of 50% coolant and 50% deionized water. (Enabled: -31°F [-35°C])

For more details about engine coolant, contact your Toyota dealer.

4-3. Do-it-yourself maintenance

CAUTION

■ When the engine is hot

Do not remove the radiator cap.
The cooling system may be under pressure and may spray hot coolant if the cap is removed, causing serious injuries, such as burns.

NOTICE

■ When adding the engine coolant

Coolant is neither plain water nor straight antifreeze. The correct mixture of water and antifreeze must be used to provide proper lubrication, corrosion protection and cooling. Be sure to read the antifreeze or coolant label.

■ If you spill coolant

Be sure to wash it off with water to prevent it damage to parts or paint.

Radiator and condenser

Check the radiator and condenser and clear any foreign objects.
If either of the above parts are extremely dirty or you are not sure of their condition, have your vehicle checked by your Toyota dealer.

CAUTION

■ When the engine is hot

Do not touch the radiator or condenser as they may be hot and cause serious injuries, such as burns.

Brake fluid

■ Checking fluid level

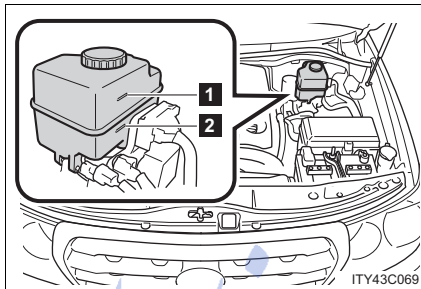

The brake fluid level should be between the “MAX” and “MIN” lines on the tank.

1 MAX

2 MIN

Make sure to check the fluid type and prepare the necessary items.

■ Adding fluid

Fluid type	FMVSS No.116 DOT 3 or SAE J1703 brake fluid
Items	Clean funnel

■ Refilling brake fluid

STEP 1 Turn the “ENGINE START STOP” switch OFF.

STEP 2 Depress the brake pedal more than 40 times.

STEP 3 Remove the reservoir cap by hand. Add brake fluid up to the “MAX” line.

If you do not follow the procedure above, the reservoir may overflow.

4-3. Do-it-yourself maintenance

■ Brake fluid can absorb moisture from the air

Excess moisture in the fluid can cause a dangerous loss of braking efficiency. Use only newly opened brake fluid.

CAUTION

■ When filling the reservoir

Take care because brake fluid can harm your hands or eyes and damage painted surfaces.

If fluid gets in your eyes, flush your eyes with clean water immediately.

If you still experience discomfort, see a doctor.

NOTICE

■ If the fluid level is low or high

It is normal for the brake fluid level to go down slightly as the brake pads wear or when the fluid level in the accumulator is high.

If the reservoir needs frequent refilling, it may indicate a serious problem.

FarmaSOS.com

Power steering fluid

■ Fluid level

The fluid level should be within the appropriate range.

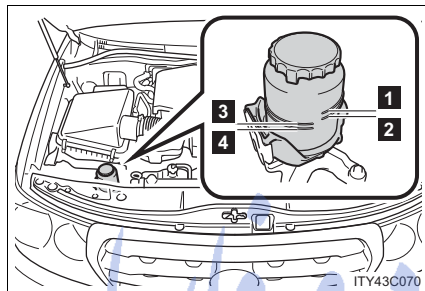

- 1 Full (when hot)
- 2 Add fluid (when hot)
- 3 Full (when cold)
- 4 Add fluid (when cold)

Hot: Vehicle has been driven around 50 mph (80 km/h) for 20 minutes, or slightly longer in frigid temperatures. (Fluid temperature, 140°F - 175°F [60°C - 80°C]).

Cold: Engine has not been run for about five hours. (Room temperature, 50°F - 85°F [10°C - 30°C]).

■ Checking the fluid level

Make sure to check the fluid type and prepare the necessary items.

Fluid type	Automatic transmission fluid DEXRON® II or III
Items	Rag or paper, Clean funnel (only for adding fluid)

- STEP 1 Clean all dirt off the reservoir.
- STEP 2 Remove the cap by turning it counterclockwise.
- STEP 3 Wipe the dipstick clean.
- STEP 4 Reinstall and remove the reservoir cap again.
- STEP 5 Check the fluid level.

4-3. Do-it-yourself maintenance

CAUTION

■ When checking the reservoir

Take care, as the reservoir may be hot.

NOTICE

■ When adding fluid

Avoid overfilling, or the power steering may be damaged.

■ After replacing the reservoir cap

Check the steering box case, vane pump and hose connections for leaks or damage.

Battery

Check the battery as follows:

■ Exterior

Make sure that the battery terminals are not corroded and that there are no loose connections, cracks, or loose clamps.

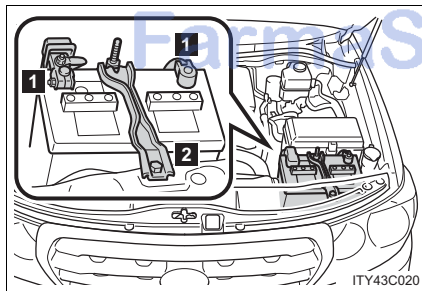

- 1 Terminals
- 2 Hold-down clamp

■ Before recharging

When recharging, the battery produces hydrogen gas which is flammable and explosive. Therefore, before recharging:

- If recharging with the battery installed on the vehicle, be sure to disconnect the ground cable.
- Make sure the power switch on the charger is off when connecting and disconnecting the charger cables to the battery.

■ After recharging the battery

The engine may not start. Follow the procedure below to initialize the system.

- STEP 1** Depress the brake pedal with the shift lever in "N".
- STEP 2** Open and close any of the doors.
- STEP 3** Restart the engine.

⚠ CAUTION

■ Chemicals in the battery

A battery contains poisonous and corrosive sulfuric acid and may produce hydrogen gas which is flammable and explosive. To reduce the risk of death or serious injury, take the following precautions while working on or near battery:

- Do not cause sparks by touching the battery terminals with tools.
- Do not smoke or light a match near the battery.
- Avoid contact with eyes, skin and clothes.
- Never inhale or swallow electrolyte.
- Wear protective safety glasses when working near the battery.
- Keep children away from the battery.

4-3. Do-it-yourself maintenance

CAUTION

■ Where to safely charge the battery

Always charge the battery in an open area. Do not charge the battery in a garage or closed room where there is not sufficient ventilation.

■ How to recharge the battery

Only perform a slow charge (5A or less). The battery may explode if charged at a quicker rate.

■ Emergency measures regarding electrolyte

- If electrolyte gets in your eyes
Flush your eyes with clean water for at least 15 minutes and get immediate medical attention. If possible, continue to apply water with a sponge or cloth while traveling to the nearest medical facility.
- If electrolyte gets on your skin
Wash the affected area thoroughly. If you feel pain or a burning sensation, seek medical attention immediately.
- If electrolyte gets on your clothes
It can soak through clothing on to your skin. Immediately take off the clothing and follow the procedure above if necessary.
- If you accidentally swallow electrolyte
Drink a large quantity of water or milk. Get emergency medical attention immediately.

NOTICE

■ When recharging the battery

Never recharge the battery while the engine is running. Also, be sure all accessories are turned off.

Washer fluid

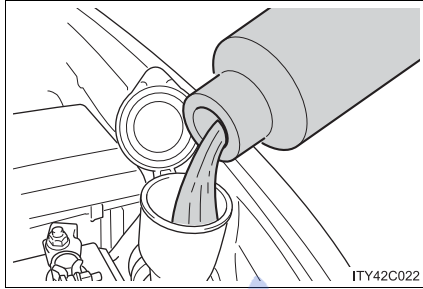

If any washer does not work or the warning message appears on the multi-information display, the washer tank may be empty. Add washer fluid.

CAUTION

■ When refilling the washer fluid

Do not refill the washer fluid when the engine is hot or running, as the washer fluid contains alcohol and may catch fire if spilled on the engine etc.

NOTICE

■ Do not use any fluid other than washer fluid

Do not use soapy water or engine antifreeze instead of washer fluid. Doing so may cause streaking on the vehicle's painted surfaces.

■ Diluting washer fluid

Dilute washer fluid with water as necessary. Refer to the freezing temperatures listed on the label of the washer fluid bottle.

4-3. Do-it-yourself maintenance Tires

Replace or rotate tires in accordance with maintenance schedules and treadwear.

■ Checking tires

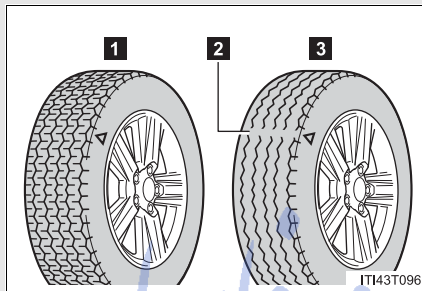

- 1 New tread
- 2 Treadwear indicator
- 3 Worn tread

The location of treadwear indicators is shown by the "TWI" or "Δ" marks, etc., molded on the sidewall of each tire.

Check spare tire condition and inflation pressure if not rotated.

■ Tire rotation

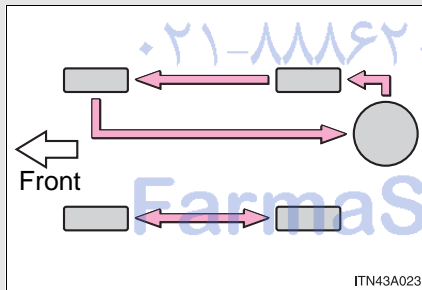

Rotate the tires in the order shown.

To equalize tire wear and extend tire life, Toyota recommends that tire rotation is carried out at the same interval as tire inspection.

Do not fail to initialize the tire pressure warning system after tire rotation.

■ The tire pressure warning system

Your Toyota is equipped with a tire pressure warning system that uses tire pressure warning valves and transmitters to detect low tire inflation pressure before serious problems arise. (→P. 611)

Installing tire pressure warning valves and transmitters

When replacing tires or wheels, tire pressure warning valves and transmitters must also be installed.

When new tire pressure warning valves and transmitters are installed, new tire pressure warning valve and transmitter ID codes must be registered in the tire pressure warning computer and tire pressure warning system must be initialized. Have tire pressure warning valve and transmitter ID codes registered by your Toyota dealer. (→P. 547)

Initializing the tire pressure warning system

■ **The tire pressure warning system must be initialized in the following circumstances:**

- When rotating the tires on vehicles differing with front and rear tire inflation pressures.
- When changing the tire inflation pressure by changing traveling speed or load weight, etc.
- When changing the tire size.

When the tire pressure warning system is initialized, the current tire inflation pressure is set as the pressure benchmark.

■ **How to initialize the tire pressure warning system**

STEP 1 Park the vehicle in safe place and turn the “ENGINE START STOP” switch to OFF.

While the vehicle is moving, initialization is not performed.

STEP 2 Adjust the tire inflation pressure to the specified cold tire inflation pressure level. (→P. 676)

Make sure to adjust the tire pressure to the specified cold tire inflation pressure level. The tire pressure warning system will operate based on this pressure level.

STEP 3 Turn the “ENGINE START STOP” switch to IGNITION ON mode.

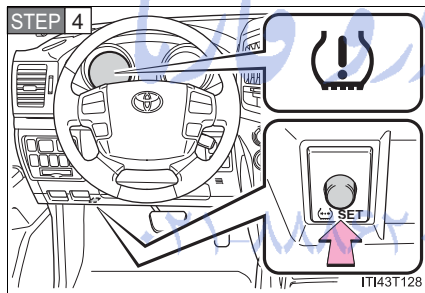

Press and hold the tire pressure warning reset switch until the tire pressure warning light blinks slowly 3 times and the message “TIRE PRESSURE RESET PROCEEDING” appears on the multi-information display.

STEP 5 Wait for a few minutes with the IGNITION ON mode, and then turn the “ENGINE START STOP” switch to OFF.

Registering ID codes

The tire pressure warning valve and transmitter is equipped with a unique ID code. When replacing a tire pressure warning valve and transmitter, it is necessary to register the ID code of tire pressure warning valve and transmitter. Have the ID code registered by your Toyota dealer.

■ When to replace your vehicle's tires

Tires should be replaced if:

- You have tire damage such as cuts, splits, cracks deep enough to expose the fabric or bulges indicating internal damage
- A tire goes flat repeatedly or cannot be properly repaired due to the size or location of a cut or other damage

If you are not sure, consult with your Toyota dealer.

■ Replacing tires and wheels

If the ID code of the tire pressure warning valve and transmitter is not registered, the tire pressure warning system will not work properly. After driving for about 20 minutes, the tire pressure warning light comes on after blinking for 1 minute to indicate a system malfunction.

■ Tire life

Any tire over 6 years old must be checked by a qualified technician even if they have seldom or never been used or damage is not obvious.

■ If the tread wears down below 0.16 in. (4 mm) on snow tires

The effectiveness of snow tires is lost.

■ Maximum load of tire

Check that the number given by dividing the maximum load by 1.10 of the replacement tire is greater than 1/2 of the Gross Axle Weight Ratings (GAWR) of either the front axle or the rear axle, whichever is greater.

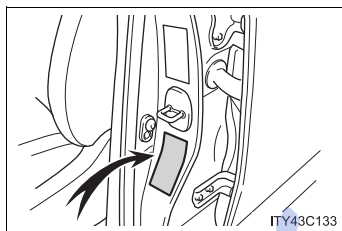

For the GAWR, see the Certification Label. For the maximum load of the tire, see the load limit at maximum cold tire inflation pressure mentioned on the sidewall of the tire. (→P. 682)

■ Tire types

1 Summer tires

Summer tires are high-speed performance tires best suited to highway driving under dry conditions. Since summer tires do not have the same traction performance as snow tires, summer tires are inadequate for driving on snow-covered or icy roads. For driving on snow-covered roads or icy roads, the use of snow tires is recommended. When installing snow tires, be sure to replace all four tires.

2 All season tires

All season tires are designed to provide better traction in snow and to be adequate for driving in most winter conditions, as well as for use year round. All season tires, however, do not have adequate traction performance compared with snow tires in heavy or loose snow. Also, all season tires fall short in acceleration and handling performance compared with summer tires in highway driving.

3 Snow tires

For driving on snow-covered roads or icy roads, we recommend using snow tires. If you need snow tires, select tires of the same size, construction and load capacity as the originally installed tires. Since your vehicle has radial tires as original equipment, make sure your snow tires also have radial construction. Do not install studded tires without first checking local regulations for possible restriction. Snow tires should be installed on all wheels. (→P. 309)

■ **Initializing the tire pressure warning system**

Initialize the tire pressure warning system with the tire inflation pressure adjusted to the specified level.

■ **If you press the tire pressure reset switch accidentally**

If initialization is performed, adjust the tire inflation pressure to the specified level and initialize the tire pressure warning system again.

■ **When the initialization of the tire pressure warning system has failed**

Initialization can be completed in a few minutes. However, in the following cases, the settings have not been recorded and the system will not operate properly. If repeated attempts to record tire inflation pressure settings are unsuccessful, have the vehicle inspected by your Toyota dealer.

- When operating the tire pressure warning reset switch, the tire pressure warning light does not blink 3 times and the setting message does not appear on the multi-information display.
- After carrying out the initialization procedure, the tire pressure warning light blinks for 1 minute then stays on after driving for about 20 minutes.

■ **Routine tire inflation pressure checks**

The tire pressure warning system does not replace routine tire inflation pressure checks. Make sure to check tire inflation pressure as part of your routine of daily vehicle checks.

4-3. Do-it-yourself maintenance

■ Tire pressure warning system certification

FCC ID: PAXPMV107J

FCC ID: HYQ13BCX

NOTE:

This device complies with part 15 of the FCC Rules. Operation is subject to the following two conditions: (1) This device may not cause harmful interference, and (2) this device must accept any interference received, including interference that may cause undesired operation.

FCC WARNING:

Changes or modifications not expressly approved by the party responsible for compliance could void the user's authority to operate the equipment.

امداد خودرو فارما

تلفن شبانه روزی: ۰۲۱-۸۸۸۶۲۰۸۵

FarmaSOS.com

⚠ CAUTION**■ Tire pressure warning system operation**

The tire pressure warning system may not provide warning immediately if a tire bursts or if sudden air leakage occurs.

■ When inspecting or replacing tires

Observe the following precautions to prevent accidents. Failure to do so may cause damage to parts of the drive train, as well as dangerous handling characteristics, which may lead to an accident resulting in death or serious injury.

- Do not mix tires of different makes, models or tread patterns.
Also, do not mix tires of remarkably different treadwear.
- Do not use tire sizes other than those recommended by Toyota.
- Do not mix differently constructed tires (radial, bias-belted or bias-ply tires).
- Do not mix summer, all season and snow tires.
- Do not use tire that have been used on another vehicle.
Do not use tires if you do not know they were used previously.

■ When initializing the tire pressure warning system

Do not push the tire pressure warning reset switch without first adjusting the tire inflation pressure to the specified level. Otherwise, the tire pressure warning light may not come on even if the tire inflation pressure is low, or it may come on when the tire inflation pressure is actually normal.

 NOTICE

■ **Repairing or replacing tires, wheels, tire pressure warning valves and transmitters and tire valve caps**

- When removing or fitting the wheels, tires or the tire pressure warning valve and transmitter, contact your Toyota dealer as the tire pressure warning valve and transmitter may be damaged if not handled correctly.
- When replacing tire valve caps, do not use tire valve caps other than those specified. The cap may become stuck.

■ **To avoid damage to the tire pressure warning valves and transmitters**

When a tire is repaired with liquid sealants, the tire pressure warning valve and transmitter may not operate properly. If a liquid sealant is used, contact your Toyota dealer or other qualified service shop as soon as possible. Make sure to replace the tire pressure warning valve and transmitter when replacing the tire. (→P. 545)

■ **Driving on rough roads**

Take particular care when driving on roads with loose surfaces or potholes.

These conditions may cause losses in tire inflation pressure, reducing the cushioning ability of the tires. In addition driving on rough roads may cause damage to the tires themselves, as well as the vehicle's wheels and body.

■ **If tire inflation pressures become low while driving**

Do not continue driving, or your tires and/or wheels may be ruined.

4-3. Do-it-yourself maintenance Tire inflation pressure

■ Tire inflation pressure

The recommended cold tire inflation pressure and tire size is displayed on the tire and loading information label. (→P. 676)

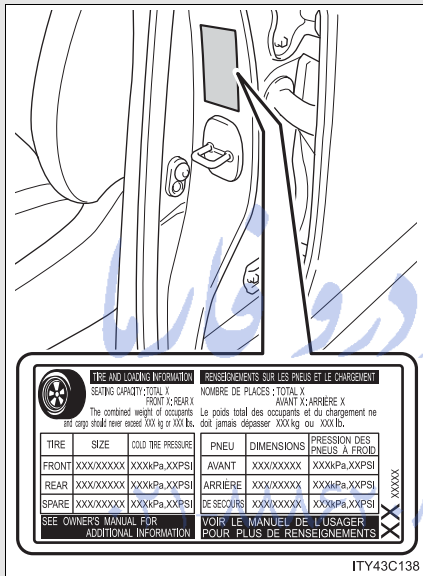

4

Maintenance and care

FarmaSOS.com

■ Inspection and adjustment procedure

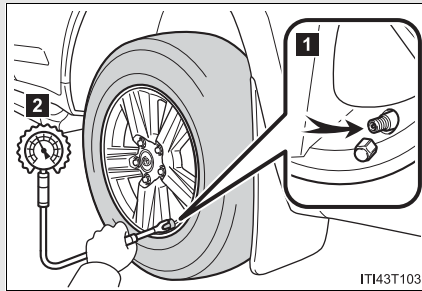

- 1 Tire valve
- 2 Tire pressure gauge

STEP 1 Remove the tire valve cap.

STEP 2 Press the tip of the tire pressure gauge onto the tire valve.

STEP 3 Read the pressure using the graduations of the gauge.

STEP 4 If the tire inflation pressure is not within the recommended levels, adjust tire pressure.
If you add too much air, press the center of the valve to lower.

STEP 5 After completing the tire inflation pressure measurement and adjustment, apply soapy water to the valve and check for leakage.

STEP 6 Reinstall the tire valve cap.

Make sure to maintain the proper tire inflation pressure. Tire inflation pressure should be checked at least once per month. However, Toyota recommends that tire inflation pressure be checked once every two weeks. (→P. 676)

■ Tire inflation pressure check interval

You should check tire inflation pressure every 2 weeks, or at least once a month.

Do not forget to check the spare.

■ **Effects of incorrect tire inflation pressure**

Driving with incorrect tire inflation pressure may result in the following:

- Reduced fuel efficiency
- Reduced driving comfort and tire life
- Reduced safety
- Damage to the drive train

If a tire needs frequent refilling, have it checked by your Toyota dealer.

■ **Instructions for checking tire inflation pressure**

When checking tire inflation pressure, observe the following:

- Check only when the tires are cold.
If your vehicle has been parked for at least 3 hours and has not been driven for more than 1 mile or 1.5 km, you will get an accurate cold tire inflation pressure reading.
- Always use a tire pressure gauge.
The appearance of the tire can be misleading. In addition, tire inflation pressures that are even just a few pounds off can degrade ride and handling.
- Do not bleed or reduce tire inflation pressure after driving. It is normal for the tire inflation pressure to be higher after driving.
- Never exceed the vehicle capacity weight.
Passengers and luggage weight should be placed so that the vehicle is balanced.

4-3. Do-it-yourself maintenance

CAUTION

■ Proper inflation is critical to save tire performance

Keep your tires properly inflated. Otherwise, the following conditions may occur and result in an accident causing death or serious injury.

- Excessive wear
- Uneven wear
- Poor handling
- Possibility of blowouts resulting from overheated tires
- Poor sealing of the tire bead
- Wheel deformation and/or tire separation
- A greater possibility of tire damage from road hazards

NOTICE

■ When inspecting and adjusting tire inflation pressure

Be sure to reinstall the tire valve caps. Without the valve caps, dirt or moisture could get into the valve and cause air leakage, which could result in an accident. If the caps have been lost, replace them as soon as possible.

4-3. Do-it-yourself maintenance Wheels

If a wheel is bent, cracked or heavily corroded, it should be replaced.

Otherwise, the tire may separate from the wheel or cause loss of handling control.

■ Wheel selection

When replacing wheels, care should be taken to ensure that they are equivalent to those removed in load capacity, diameter, rim width, and inset*.

Replacement wheels are available at your Toyota dealer.

*: Conventionally referred to as "offset".

Toyota does not recommend using:

- Wheels of different sizes or types
- Used wheels
- Bent wheels that have been straightened

■ Aluminum wheel precautions

- Use only Toyota wheel nuts and wrenches designed for use with your aluminum wheels.
- When rotating, repairing or changing your tires, check that the wheel nuts are still tight after driving 1000 miles (1600 km).
- Be careful not to damage the aluminum wheels when using tire chains.
- Use only Toyota genuine balance weights or equivalent and a plastic or rubber hammer when balancing your wheels.

■ When replacing wheels

The wheels of your Toyota are equipped with tire pressure warning valves and transmitters that allow the tire pressure warning system to provide advanced warning in the event of a loss in tire inflation pressure. Whenever wheels are replaced, the tire pressure warning valves and transmitters must be installed. (→P. 545)

⚠ CAUTION

■ When replacing wheels

- Do not use wheels that are a different size from those recommended in the Owner's Manual, as this may result in loss of handling control.
- Never use an inner tube in a leaking wheel which is designed for a tubeless tire. Doing so may result in an accident, causing death or serious injury.

■ When installing the wheel nuts

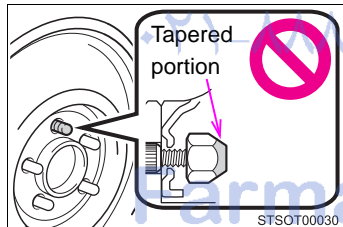

- Be sure to install the wheel nuts with the tapered ends facing inward. Installing the nuts with the tapered ends facing outward can cause the wheel to break and eventually cause the wheel to come off while driving, which could lead to an accident resulting in death or serious injury.

- Never use oil or grease on the wheel bolts or wheel nuts.
Oil and grease may cause the wheel nuts to be excessively tightened, leading to bolt or disc wheel damage. In addition, the oil or grease can cause the wheel nuts to loosen and the wheel may fall off, causing an accident and resulting in death or serious injury. Remove any oil or grease from the wheel bolts or wheel nuts.

■ Use of defective wheels prohibited

Do not use cracked or deformed wheels.
Doing so could cause the tire to leak air during driving, possibly causing an accident.

 NOTICE

■ **Replacing tire pressure warning valves and transmitters**

- Because tire repair or replacement may affect the tire pressure warning valves and transmitters, make sure to have tires serviced by your Toyota dealer or other qualified service shop. In addition, make sure to purchase your tire pressure warning valves and transmitters at your Toyota dealer.
- Ensure that only genuine Toyota wheels are used on your vehicle. Tire pressure warning valves and transmitters may not work properly with non-genuine wheels.

امداد خودرو فارما

تلفن شبانه روزی: ۰۲۱-۸۸۸۶۲۰۸۵

FarmaSOS.com

4-3. Do-it-yourself maintenance Air conditioning filter

The air conditioning filter must be cleaned or changed regularly to maintain air conditioning efficiency.

■ Removal method

STEP 1 Turn the “ENGINE START STOP” switch IGNITION ON mode and switch to recirculated air mode, then turn the “ENGINE START STOP” switch OFF.

STEP 2 Open the glove box and remove the separate tray. (→P. 467)

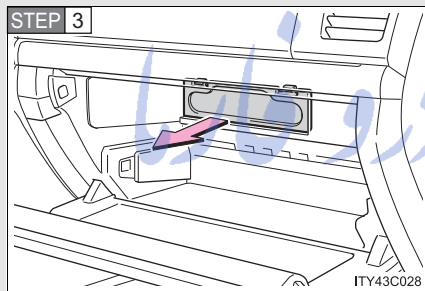

Remove the filter cover.

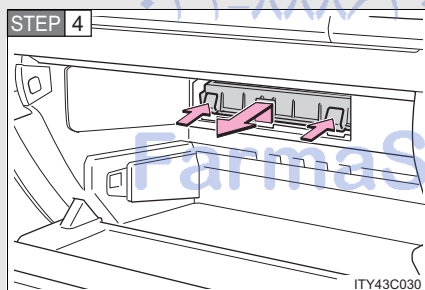

Remove the filter case.

■ **Cleaning method**

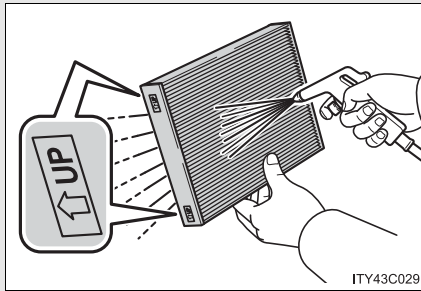

If the filter is dirty, clean by blowing compressed air through the filter from the downward side.

Hold the air gun 2 in. (5 cm) from the filter and blow for approximately 2 minutes at 72 psi (500 kPa, 5.0 kgf/cm² or bar).

If it is not available, have the filter cleaned by your Toyota dealer.

■ **Replacement method**

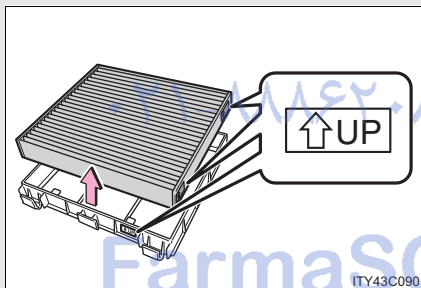

Remove the air conditioning filter and replace it with a new one.

The "↑UP" marks shown on the filter should be pointing up.

4-3. Do-it-yourself maintenance

■ Checking interval

Inspect, clean and replace the air conditioning filter according to the maintenance schedule. In dusty areas or areas with heavy traffic flow, more frequent cleaning or early replacement may be required. (For scheduled maintenance information, read the "Scheduled Maintenance Guide", "Owner's Manual Supplement".)

■ If air flow from the vents decreases dramatically

The filter may be clogged. Check the filter and replace if necessary.

NOTICE

■ To prevent damage to the system

- When using the air conditioning system, make sure that a filter is always installed.
- When cleaning the filter, do not clean the filter with water.

تلفن شبانه روزی: ۰۲۱-۸۸۶۲۰۸۵

FarmaSOS.com

4-3. Do-it-yourself maintenance Electronic key battery

Replace the battery with a new one if it is discharged.

■ You will need the following items:

- Flathead screwdriver (To prevent damage to the key, cover the tip of the screwdriver with rag.)
- Small Phillips-head screwdriver
- Lithium battery CR1632

■ Replacing the battery

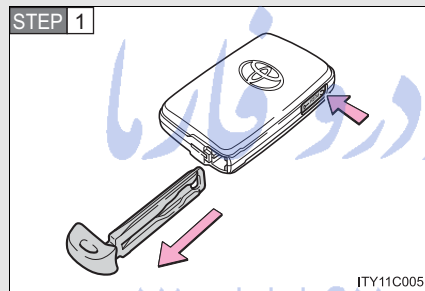

Take out the mechanical key.

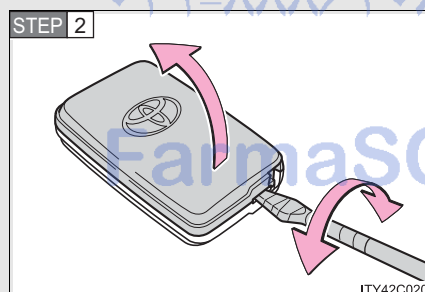

Remove the cover.

4-3. Do-it-yourself maintenance

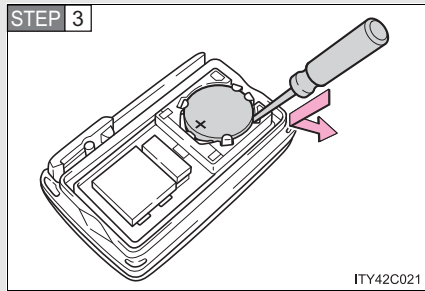

Remove the depleted battery.

Insert a new battery with the "+" terminal facing up.

■ If the electronic key battery is discharged

The following symptoms may occur.

- The smart key system and wireless remote control will not function properly.
- The operational range is reduced.

■ Use a CR1632 lithium battery

- Batteries can be purchased at your Toyota dealer, jewelers, or camera stores.
- Replace only with the same or equivalent type recommended by a Toyota dealer.
- Dispose of used batteries according to the local laws.

 CAUTION

■ **Removed battery and other parts**

These parts are small and if swallowed by a child, they can cause choking. Keep away from children. Failure to do so could result in death or serious injury.

 NOTICE

■ **For normal operation after replacing the battery**

Observe the following precautions to prevent accidents.

- Always work with dry hands.
Moisture may cause the battery to rust.
- Do not touch or move any other components inside the electronic key.
- Do not bend the battery terminals.

تلفن شبانه روزی: ۰۲۱-۸۸۶۲۰۸۵

FarmaSOS.com

4-3. Do-it-yourself maintenance Checking and replacing fuses

If any of the electrical components do not operate, a fuse may have blown. If this happens, check and replace the fuses as necessary.

STEP 1 Turn the “ENGINE START STOP” switch OFF.

STEP 2 Open the fuse box cover.

► Engine compartment (fuse box on the left side)

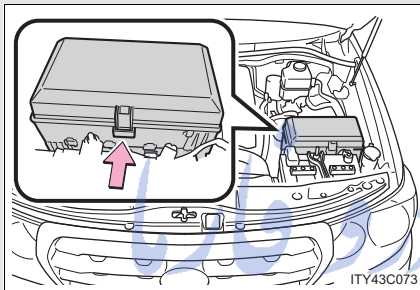

Push the tab in and lift the lid off.

► Engine compartment (fuse box on the right side)

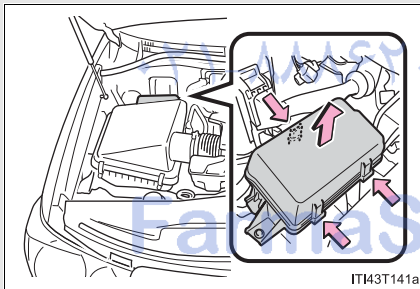

Push the tabs in and lift the lid off.

► Driver's side instrument panel

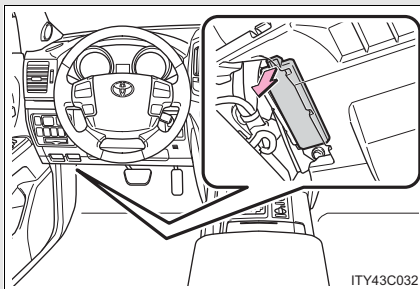

Remove the lid.

▶ Passenger's side instrument panel

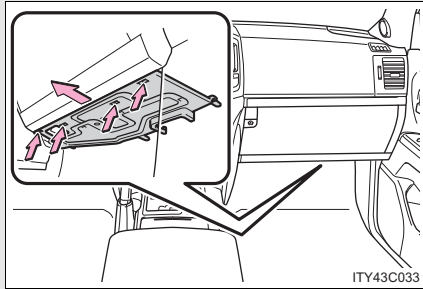

Remove the cover.

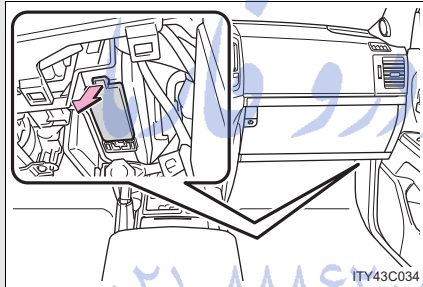

Remove the lid.

STEP 3 After a system failure, see "Fuse layout and amperage ratings" (→P. 570) for details about which fuse to check.

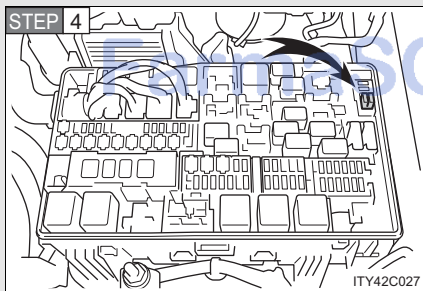

STEP 4 Remove the fuse with the pull-out tool.

4-3. Do-it-yourself maintenance

STEP 5 Check if the fuse has blown.

► Type A and B

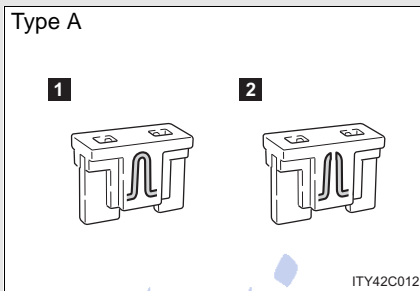

1 Normal fuse

2 Blown fuse

Replace it with one of an appropriate amperage rating. The amperage rating can be found on the fuse box lid.

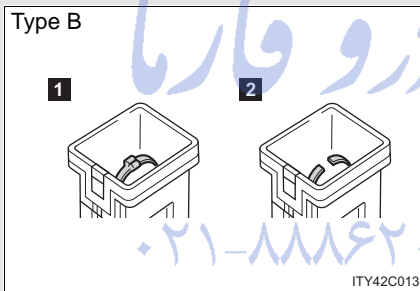

امداد خودرو فارما
تلفن شبانه روزی: ۰۲۱-۸۸۶۲۰۸۵

FarmaSOS.com

► Type C and D

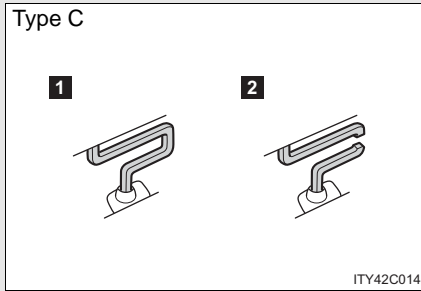

1 Normal fuse

2 Blown fuse

Contact your Toyota dealer.

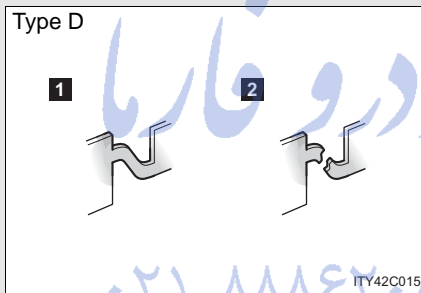

Fuse layout and amperage ratings

■ Engine compartment (fuse box on the left side)

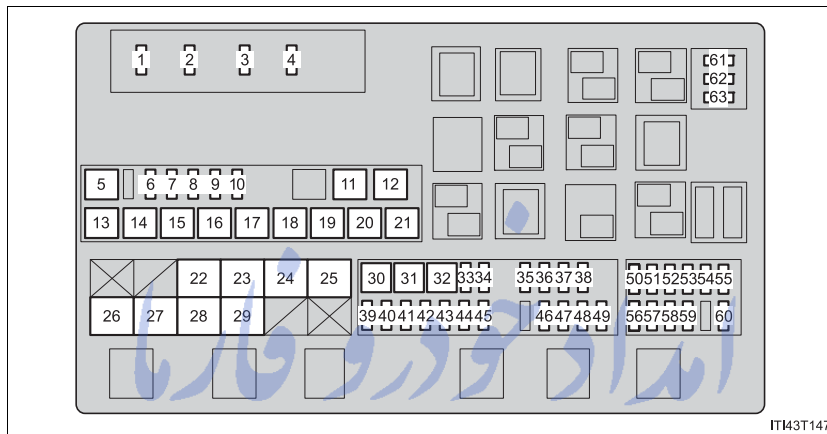

Fuse	Ampere	Circuit
1	A/F 15 A	A/F heater
2	HORN 10 A	Horn
3	EFI MAIN 25 A	EFI, A/F heater, fuel pump
4	IG2 MAIN 30 A	INJ, IGN, MET
5	RR A/C 50 A	Blower controller
6	CDS FAN 25 A	Condenser fan
7	RR S/HTR 20 A	Rear seat heater
8	FR FOG 7.5 A	Front fog lights
9	STOP 15 A	Stoptlights, high mounted stoplight, brake controller, ABS, VSC, main body ECU, EFI, trailer
10	SEAT-A/C LH 25 A	Seat heaters and ventilators

Fuse		Ampere	Circuit
11	HWD4	30 A	No circuit
12	HWD3	30 A	No circuit
13	AHC	50 A	No circuit
14	PTC-1	50 A	PTC heater
15	PTC-2	50 A	PTC heater
16	PTC-3	50 A	PTC heater
17	RH-J/B	50 A	RH-J/B
18	SUB BATT	40 A	Towing
19	VGRS	40 A	VGRS ECU
20	H-LP CLN	30 A	Headlight cleaner
21	DEFOG	30 A	Rear window defogger
22	SUB-R/B	100 A	SUB-R/B
23	HTR	50 A	Front air conditioning system
24	PBD	30 A	No circuit
25	LH-J/B	150 A	LH-J/B
26	ALT	180 A	Alternator
27	A/PUMP NO.1	50 A	AI DRIVER
28	A/PUMP NO.2	50 A	AI DRIVER 2
29	MAIN	40 A	Headlight, daytime running light system, HEAD LL, HEAD RL, HEAD LH, HEAD RH
30	ABS1	50 A	ABS

4-3. Do-it-yourself maintenance

Fuse		Ampere	Circuit
31	ABS2	30 A	ABS
32	ST	30 A	Starter system
33	IMB	7.5 A	ID code box, smart key system, GBS
34	AM2	5 A	Main body ECU
35	DOME2	7.5 A	Vanity lights, overhead module, rear interior light
36	ECU-B2	5 A	Driving position memory system
37	AMP 2	30 A	Audio system
38	RSE	7.5 A	Rear seat entertainment
39	TOWING	30 A	Towing
40	DOOR NO.2	25 A	Main body ECU
41	STR LOCK	20 A	Steering lock system
42	TURN-HAZ	15 A	Meter, front turn signal lights, side turn signal lights, rear turn signal lights, trailer
43	EFI MAIN2	20 A	Fuel pump
44	ETCS	10 A	EFI
45	ALT-S	5 A	IC-ALT
46	AMP 1	30 A	Audio system
47	RAD NO.1	10 A	Navigation system, audio system, parking assist system

Fuse		Ampere	Circuit
48	ECU-B1	5 A	Smart key system, overhead module, tilt and telescopic steering, meter, cool box, gateway ECU, steering sensor
49	DOME1	10 A	Illuminated entry system, clock
50	HEAD LH	15 A	Headlight high beam (left)
51	HEAD LL	15 A	Headlight low beam (left)
52	INJ	10 A	Injector, ignition system
53	MET	5 A	Meter
54	IGN	10 A	Circuit open, SRS airbag system, gateway ECU, smart key system, ABS, VSC, steering lock system, GBS
55	DRL	5 A	Daytime running light
56	HEAD RH	15 A	Headlight high beam (right)
57	HEAD RL	15 A	Headlight low beam (right)
58	EFI NO.2	7.5 A	Air injection system, air flow meter
59	RR A/C NO.2	7.5 A	No circuit
60	DEF NO.2	5 A	Outside rear view mirror defoggers
61	SPARE	5 A	Spare fuse
62	SPARE	15 A	Spare fuse
63	SPARE	30 A	Spare fuse

4-3. Do-it-yourself maintenance

■ Engine compartment (fuse box on the right side)

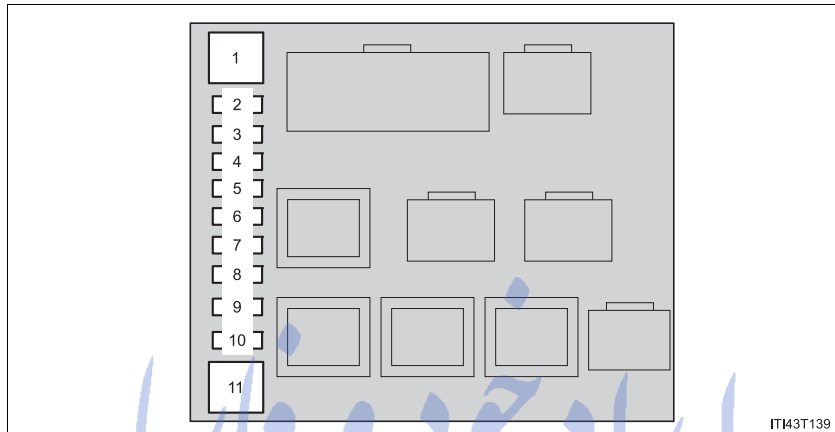

	Fuse	Ampere	Circuit
1	HWD1	30 A	No circuit
2	TOW BRK	30 A	Brake controller
3	RR P/SEAT	30 A	No circuit
4	PWR HTR	7.5 A	No circuit
5	DEICER	20 A	Windshield wiper de-icer
6	ALT-CDS	10 A	ALT-CDS
7	SECURITY	5 A	SECURITY
8	SEAT A/C RH	25 A	Seat heaters and ventilators
9	AI PMP HTR	10 A	AI pump heater
10	TOW TAIL	30 A	Towing tail light system
11	HWD2	30 A	No circuit

■ Driver's side instrument panel

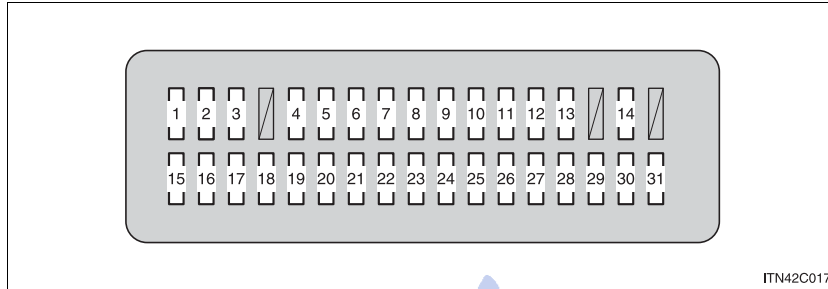

Fuse		Ampere	Circuit
1	CIG	15 A	Cigarette lighter
2	BK/UP LP	10 A	Back-up lights, trailer
3	ACC	7.5 A	Audio system, multi-display assembly, main body ECU, mirror ECU, rear seat entertainment, smart key system, clock
4	PANEL	10 A	Four-wheel drive system, ash-tray, cigarette lighter, brake controller, cool box, cruise control, center differential lock, multi-display assembly, seat heater, air conditioning system, glove box light, emergency flashers, audio system, headlight cleaner switch, inverter, driving position memory system, outside rear view mirror switches, overhead module, roll sensing of curtain shield airbags off switch, shift lever switch, steering switches, VSC OFF switch, console switch

4

Maintenance and care

4-3. Do-it-yourself maintenance

Fuse		Ampere	Circuit
5	ECU-IG NO.2	10 A	Air conditioning system, heater, overhead module, ABS, VSC, steering sensor, yaw rate & G sensor, main body ECU, stoplights, moon roof, clock, EC mirror
6	WINCH	5 A	No circuit
7	A/C IG	10 A	Cool box, condenser fan, cooler compressor, rear window and outside rear view mirror defoggers, air conditioning system
8	TAIL	15 A	Tail lights, license plate lights, front fog lights, front side marker lights, rear side marker lights, parking lights
9	WIPER	30 A	Windshield wiper
10	WSH	20 A	Windshield washer
11	RR WIPER	15 A	Rear window wiper and washer
12	4WD	20 A	4WD
13	LH-IG	5 A	Alternator, seat heater, windshield wiper de-icer, front seat belt, emergency flasher, inverter, shift lever switch
14	ECU-IG NO.1	5 A	ABS, VSC, tilt and telescopic steering, gateway ECU, shift lock system, cruise control system, pre-collision seat belt, headlight cleaner, multi-display assembly, driving position memory system, power door lock system
15	S/ROOF	25 A	Moon roof

4-3. Do-it-yourself maintenance

	Fuse	Ampere	Circuit
16	RR DOOR RH	20 A	Power windows
17	MIR	15 A	Mirror ECU, outside rear view mirror defoggers
18	RR DOOR LH	20 A	Power windows
19	FR DOOR LH	20 A	Power windows
20	FR DOOR RH	20 A	Power windows
21	RR FOG	7.5 A	No circuit
22	A/C	7.5 A	Air conditioning system
23	AM1	5 A	No circuit
24	TI & TE	15 A	Tilt and telescopic steering
25	FR P/SEAT RH	30 A	Power seat
26	PWR OUTLET	15 A	Power outlet
27	OBD	7.5 A	On-Board diagnosis
28	PSB	30 A	Pre-collision seat belt
29	DR/LCK	25 A	Main body ECU
30	FR P/SEAT LH	30 A	Power seat
31	INVERTER	15 A	Inverter

تلفن شبانه روزی: ۰۲۱-۸۸۶۲۰۸۵

FarmaSOS.com

4

Maintenance and care

4-3. Do-it-yourself maintenance

■ Passenger's side instrument panel

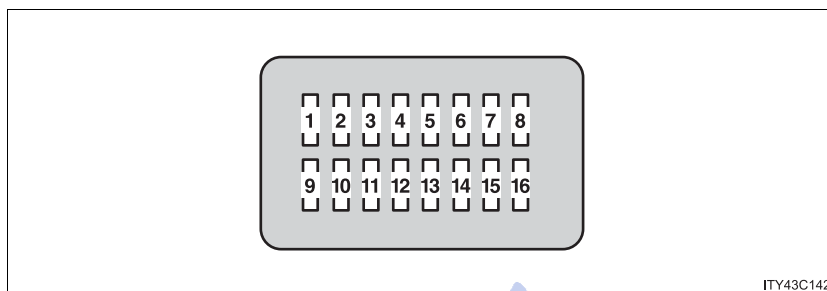

ITY43C142

	Fuse	Ampere	Circuit
1	RSF LH	30 A	No circuit
2	B/DR CLSR RH	30 A	No circuit
3	B/DR CLSR LH	30 A	No circuit
4	RSF RH	30 A	No circuit
5	DOOR DL	15 A	No circuit
6	AHC-B	20 A	No circuit
7	TEL	5 A	Multimedia
8	TOW BK/UP	7.5 A	Towing
9	AHC-B NO.2	10 A	No circuit
10	ECU-IG NO.4	5 A	Tire pressure warning system
11	SEAT-A/C FAN	10 A	Ventilators
12	SEAT-HTR	20 A	Seat heater
13	AFS	5 A	No circuit
14	ECU-IG NO.3	5 A	Cruise control system
15	STRG HTR	10 A	Heated steering system
16	TV	10 A	Multi-display assembly

■ **After a fuse is replaced**

- If the lights do not turn on even after the fuse has been replaced, a bulb may need replacement. (→P. 582)
- If the replaced fuse blows again, have the vehicle inspected by your Toyota dealer.

■ **If there is an overload in the circuits**

The fuses are designed to blow, protecting the wiring harness from damage.

 **CAUTION**

■ **To prevent system breakdowns and vehicle fire**

Observe the following precautions.
Failing to do so may cause damage to the vehicle, and possibly a fire or injury.

- Never use a fuse of a higher amperage rating than indicated, or use any other object in place of a fuse.
- Always use a genuine Toyota fuse or equivalent.
Never replace a fuse with a wire, even as a temporary fix.
- Do not modify fuses or the fuse box.

 **NOTICE**

■ **Before replacing fuses**

Have the cause of electrical overload determined and repaired by your Toyota dealer.

4-3. Do-it-yourself maintenance Headlight aim

■ Vertical movement adjustment bolts

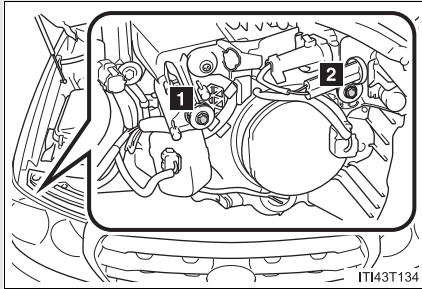

- 1 Adjustment bolt A
(Vertical adjustment)
- 2 Adjustment bolt B
(Horizontal adjustment)

■ Before checking the headlight aim

- STEP 1 Make sure the vehicle has a full tank of gasoline and the area around the headlight is not deformed.
- STEP 2 Park the vehicle on level ground.
- STEP 3 Sit in the driver's seat.
- STEP 4 Bounce the vehicle several times.

تلفن شبانه روزی: ۰۲۱-۸۸۸۶۲۰۸۵

FarmaSOS.com

■ Adjusting the headlight aim

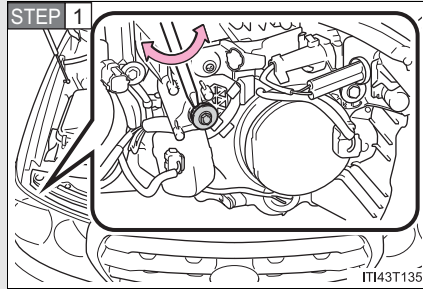

Using a Phillips-head screwdriver, turn bolt A in either direction.

Remember the turning direction and the number of turns.

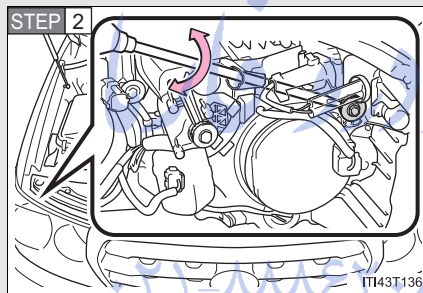

Turn bolt B the same number of turns and in the same direction as **STEP 1**.

If the headlight cannot be adjusted using this procedure, take the vehicle to your Toyota dealer to adjust the headlight aim.

FarmaSOS.com

4-3. Do-it-yourself maintenance Light bulbs

You may replace the following bulbs yourself. The difficulty level of replacement varies depending on the bulb. If necessary bulb replacement seems difficult to perform, contact your Toyota dealer. For more information about replacing other light bulbs, contact your Toyota dealer.

■ Prepare a replacement light bulb

Check the wattage of the light bulb being replaced. (→P. 677)

■ Remove the engine compartment cover

→P. 530

■ Front bulb locations

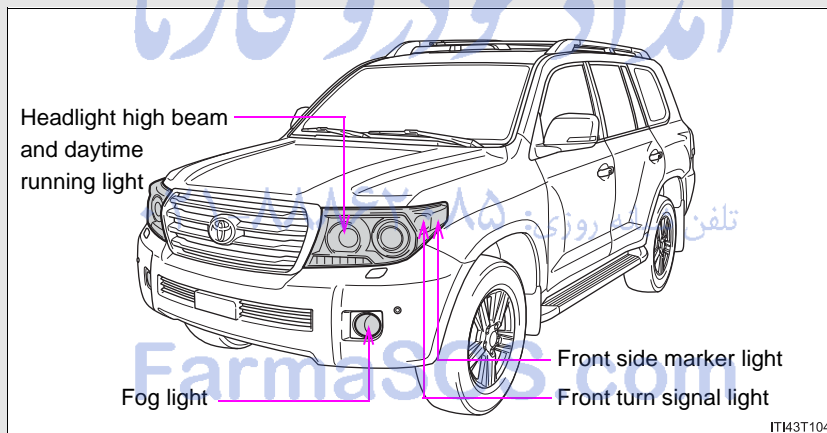

■ Rear bulb locations

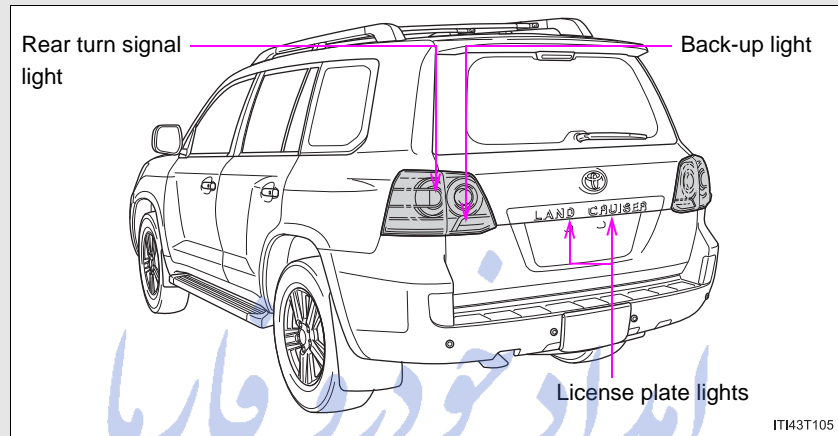

تلفن شبانه روزی: ۰۲۱-۸۸۸۶۲۰۸۵

FarmaSOS.com

Replacing light bulbs

■ Headlight high beam and daytime running light

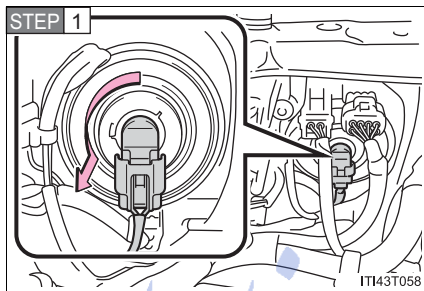

Turn the bulb base counterclockwise.

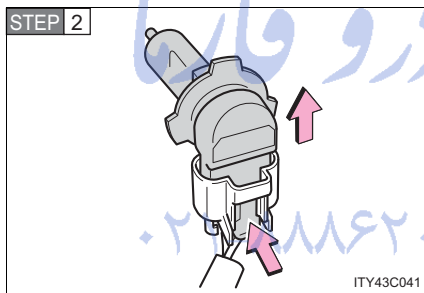

Unplug the connector while depressing the lock release.

FarmaSOS.com

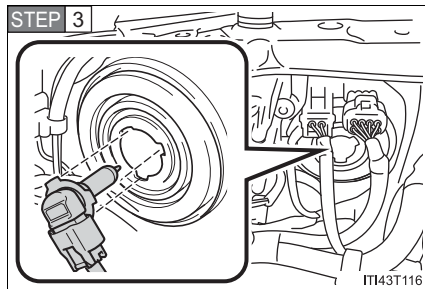

Replace the light bulb, and install the bulb base.

Align the 3 tabs on the light bulb with the mounting, and insert.

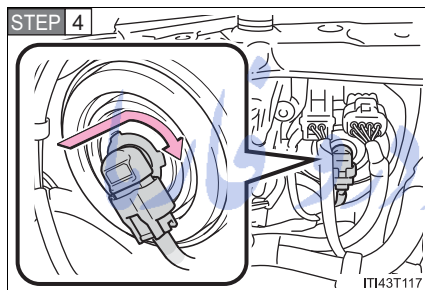

Turn and secure the bulb base.

Shake the bulb base gently to check that it is not loose, turn the headlights on once and visually confirm that no light is leaking through the mounting.

تلفن شبانه روزی: ۰۲۱-۸۸۶۲۰۸۵

FarmaSOS.com

4-3. Do-it-yourself maintenance

■ Fog light

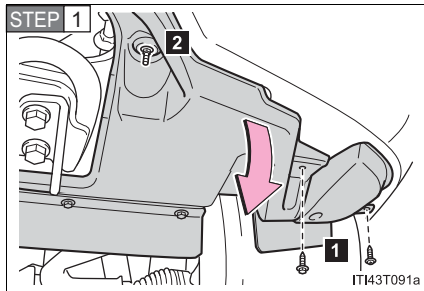

Remove the fender liner bolts, loose the fender liner nut and pull down the fender liner.

1 Fender liner bolts

2 Fender liner nut

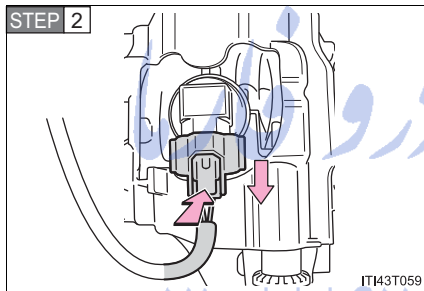

Unplug the connector while depressing the lock release.

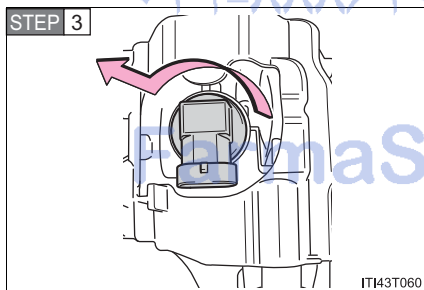

Turn the light bulb counterclockwise.

4-3. Do-it-yourself maintenance

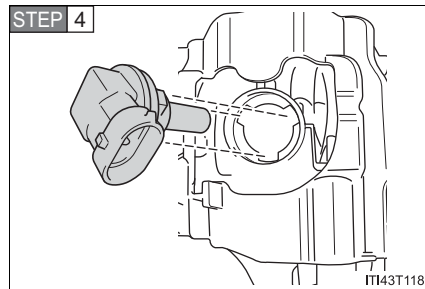

Replace the light bulb.

Align the 3 tabs on the light bulb with the mounting, and insert.

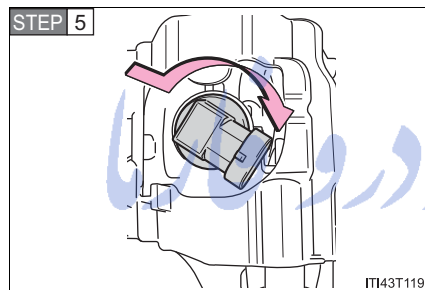

Turn and secure the light bulb.

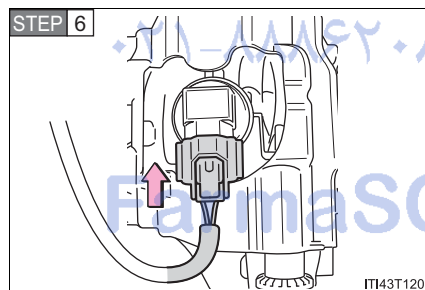

Install the bulb base.

Shake the bulb base gently to check that it is not loose, turn the fog lights on once and visually confirm that no light is leaking through the mounting.

STEP 7 When installing the fender liner, conduct **STEP 1** in reverse.

4

Maintenance and care

4-3. Do-it-yourself maintenance

■ Front turn signal light

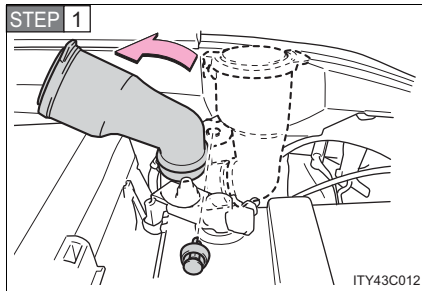

For the left side only: Remove the securing bolt and move the washer fluid filler opening.

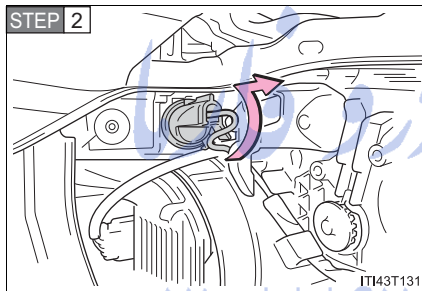

Turn the bulb base counterclockwise.

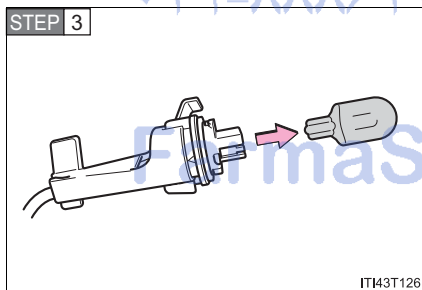

Remove the light bulb.

STEP 4 When installing, reverse the steps listed.

■ Front side marker light

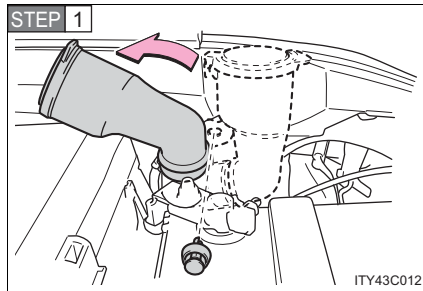

For the left side only: Remove the securing bolt and move the washer fluid filler opening.

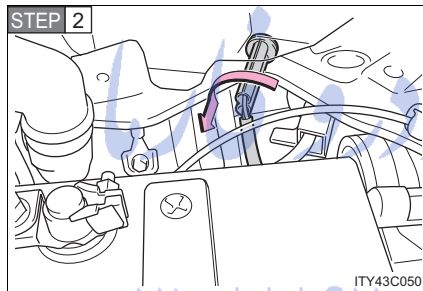

Turn the bulb base counterclockwise.

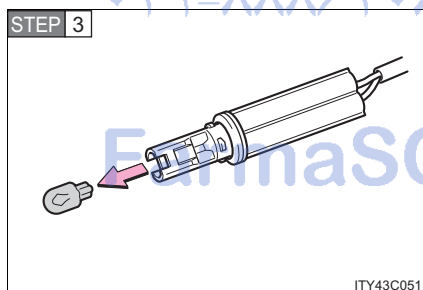

Remove the light bulb.

STEP 4 When installing, reverse the steps listed.

4-3. Do-it-yourself maintenance

■ Back-up light

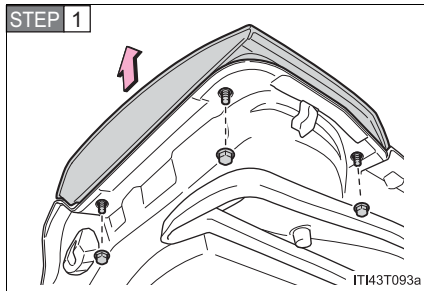

Open the back door and remove the nuts and lamp assembly.

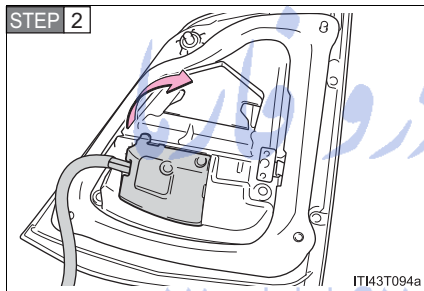

Remove the cover.

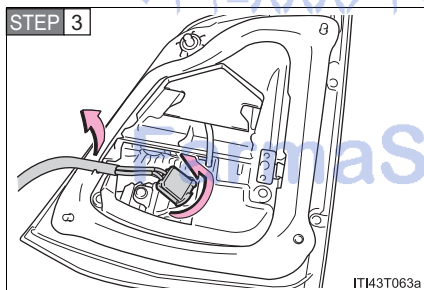

Unclip the connector wire and turn the bulb bases counter-clockwise.

4-3. Do-it-yourself maintenance

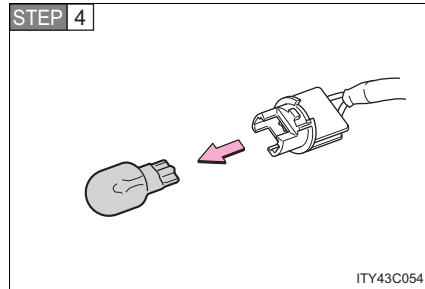

Remove the light bulb.

STEP 5 When installing, reverse the steps listed.

امداد خودرو فارما

تلفن شبانه روزی: ۰۲۱-۸۸۸۶۲۰۸۵

FarmaSOS.com

4-3. Do-it-yourself maintenance

■ Rear turn signal light

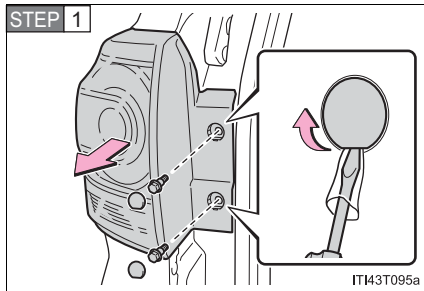

Open the back door and remove the bolts and lamp assembly.

Use a cloth to prevent scratches.

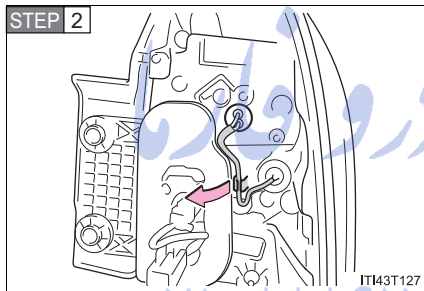

Unclip the connector wire.

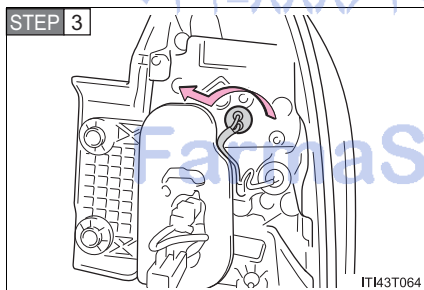

Turn the bulb bases counter-clockwise.

4-3. Do-it-yourself maintenance

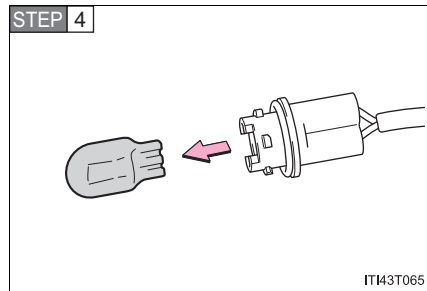

Remove the light bulb.

STEP 5 When installing, reverse the steps listed.

امداد خودرو فارما

تلفن شبانه روزی: ۰۲۱-۸۸۸۶۲۰۸۵

FarmaSOS.com

4-3. Do-it-yourself maintenance

■ License plate light

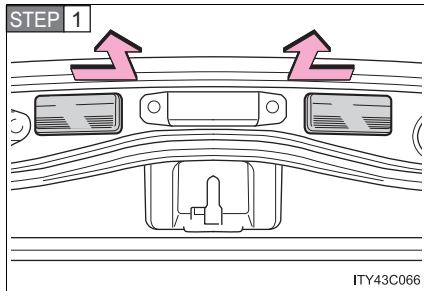

Open the back door and remove the license plate light unit.

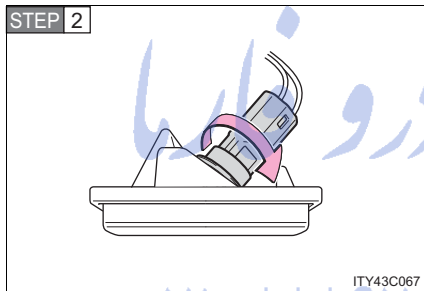

Turn the bulb base counterclockwise.

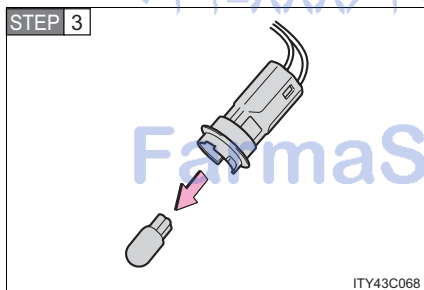

Remove the light bulb.

STEP 4 When installing, reverse the steps listed.

■ Bulbs other than the above

If any of the bulbs listed below has burnt out, have your Toyota dealer replace it.

- Headlight low beam
- Parking light
- Side turn signal light
- Stop/tail lights
- Tail lights
- High mounted stoplight
- Rear side marker lights

■ Discharge headlights

If voltage to the discharge bulbs is insufficient, the bulbs may not come on, or may go out temporarily. The discharge bulbs will come on when normal power is restored.

■ Condensation build-up on the inside of the lens

Temporary condensation build-up on the inside of the headlight lens does not indicate a malfunction. Contact your Toyota dealer for more information in the following situations:

- Large drops of water are built up on the inside of the lens.
- Water has built up inside the headlight.

■ LED lights

The parking light, side turn signal light, stop/tail lights, tail lights, high mounted stoplight and rear side marker lights consist of a number of LEDs. If any LEDs burn out, take your vehicle to your Toyota dealer to have the light replaced.

! CAUTION

■ Replacing light bulbs

- Turn off the headlights. Do not attempt to replace the bulb immediately after turning off the headlights.
The bulbs become very hot and may cause burns.
- Do not touch the glass portion of the light bulb with bare hands. When it is unavoidable to hold the glass portion, use and hold with a clean dry cloth to avoid getting moisture and oils on the bulb.
Also, if the bulb is scratched or dropped, it may blow out or crack.
- Fully install light bulbs and any parts used to secure them. Failing to do so may result in heat damage, fire, or water entering the headlight unit. This may damage the headlights or cause condensation to build up on the lens.

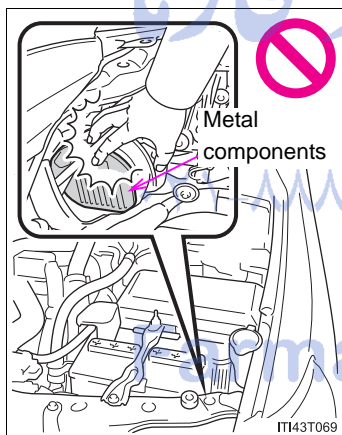

- While the low beam headlights are turned on, and for a short time after they have been turned off, metal components at the rear of the headlight assembly will be extremely hot.
To prevent burns, do not touch these metal components until you are certain they have cooled down.

 CAUTION

■ **Discharge headlights**

- Contact your Toyota dealer before replacing high-intensity discharge headlights (including light bulbs).
- Do not touch the high-intensity discharge headlight's high voltage socket when the headlights are turned on.

An extremely high voltage of 30000 V will be discharged and could result in serious injury or death by electric shock.

- Do not attempt to take apart or repair the low beam discharge headlight bulbs, connectors, power supply circuits, or related components. Doing so could result in electric shock and serious injury or death.

■ **To prevent damage or fire**

Make sure bulbs are fully seated and locked.

تلفن شبانه روزی: ۰۲۱-۸۸۶۲۰۸۵

FarmaSOS.com

4-3. Do-it-yourself maintenance

امداد خودرو فارما

تلفن شبانه روزی: ۰۲۱-۸۸۸۶۲۰۸۵

FarmaSOS.com

When trouble arises

5

5-1. Essential information

Emergency flashers	600
If your vehicle needs to be towed	601
If you think something is wrong	606
Fuel pump shut off system	607

5-2. Steps to take in an emergency

If a warning light turns on or a warning buzzer sounds... ..	608
If a warning message is displayed	619
If you have a flat tire.....	635
If the engine will not start.....	649
If the shift lever cannot be shifted from P.....	651
If you lose your keys	652
If the electronic key does not operate properly.....	653
If the battery is discharged	656
If your vehicle overheats	659
If the vehicle becomes stuck	662
If your vehicle has to be stopped in an emergency	664

5-1. Essential information Emergency flashers

The emergency flashers are used to warn other drivers when the vehicle has to be stopped in the road due to a breakdown, etc.

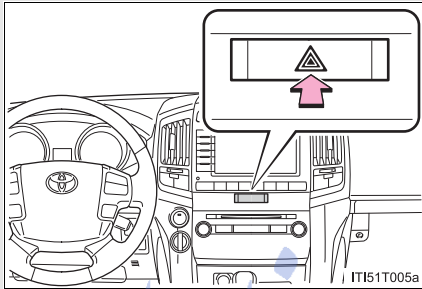

Press the switch.

All the turn signal lights will flash.

To turn them off, press the switch once again.

■ Emergency flashers

If the emergency flashers are used for a long time while the engine is not operation, the battery may discharge.

تلفن شبانه روزی: ۰۲۱-۸۸۶۲۰۸۵

FarmaSOS.com

5-1. Essential information

If your vehicle needs to be towed

If towing is necessary, we recommend having your vehicle towed by your Toyota dealer or a commercial towing service, using a lift-type truck or a flat bed truck.

Use a safety chain system for all towing, and abide by all state/provincial and local laws.

Use a towing dolly or flat bed truck.

Before towing

The following may indicate a problem with your transmission. Contact your Toyota dealer before towing.

- The engine is running, but the vehicle will not move.
- The vehicle makes an abnormal sound.

Emergency towing

If a tow truck is not available in an emergency, your vehicle may be temporarily towed using a cable or chain secured to the towing hook(s). This should only be attempted on hard, surfaced roads for short distances at low speeds.

A driver must be in the vehicle to steer and operate the brakes. The vehicle's wheels, drive train, axles, steering and brakes must be in good condition.

► Towing hook

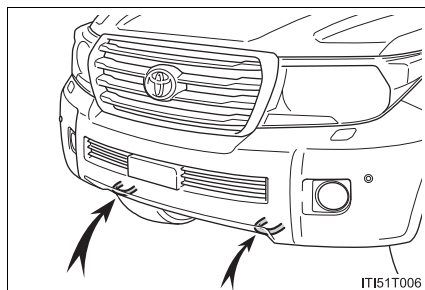

5-1. Essential information

■ Emergency towing procedure

- STEP 1** The engine must be in ACCESSORY mode (engine off) or IGNITION ON mode (engine running).
- STEP 2** Put the four-wheel drive control switch in "H4". (The center differential is unlocked.)
- STEP 3** Put the shift lever in "N".
- STEP 4** Release the parking brake.

⚠ CAUTION

■ While towing

- Use extreme caution when towing the vehicle. Avoid sudden starts or erratic driving maneuvers which place excessive stress on the emergency towing hook and the cable or chain. Always be cautious of the surroundings and other vehicles while towing.
- If the engine is not running, the power assist for the brakes and steering will not function, making steering and braking more difficult.

⚠ NOTICE

■ To prevent causing serious damage to the transmission

- Never tow this vehicle with the wheels on the ground.
- Use only the front emergency towing hooks or towing eyelets (depending on vehicles) when towing your vehicle.

Towing with a sling-type truck

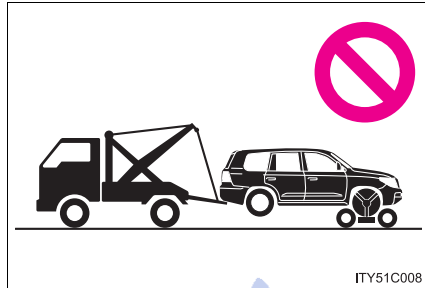

⚠ NOTICE

■ To prevent body damage

Do not tow with a sling type truck, either from the front or rear.

تلفن شبانه روزی: ۰۲۱-۸۸۶۲۰۸۵

FarmaSOS.com

5-1. Essential information

Towing with a wheel lift-type truck

► From front

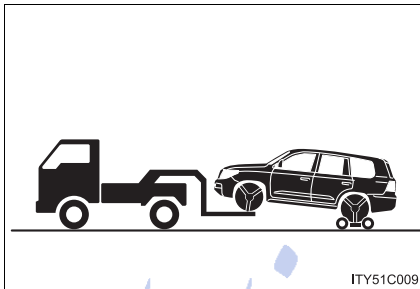

Use a towing dolly under the rear wheels.

► From rear

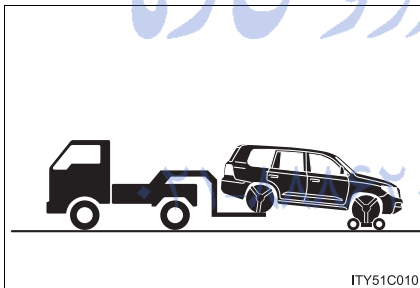

Use a towing dolly under the front wheels.

⚠ NOTICE

■ To prevent causing serious damage to the transmission

Never tow this vehicle wheels on the ground.

■ To prevent damaging the vehicle

- Do not tow the vehicle with the “ENGINE START STOP” switch OFF. The steering lock mechanism is not strong enough to hold the front wheel straight.
- When raising the vehicle, ensure adequate ground clearance for towing at the opposite end of the raised vehicle. Without adequate clearance, the vehicle could be damaged while being towed.

Using a flat bed truck

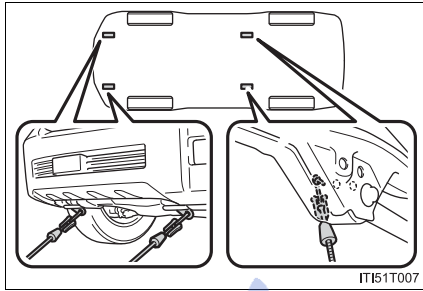

If your Toyota is transported by a flat bed truck, it should be tied down at the locations shown in the illustration. When attaching the hooks to the rear of the vehicle, make sure to attach them to the inside of the vehicle.

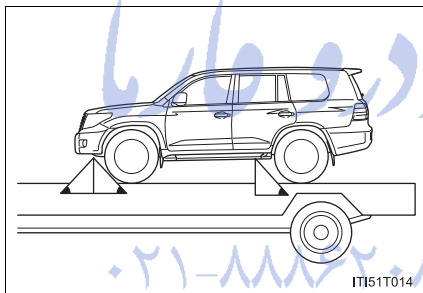

If you use chains or cables to tie down your vehicle, the angles shaded in black must be 45°.

Do not overly tighten the tie downs or the vehicle may be damaged.

⚠ NOTICE

■ To avoid serious damage to your vehicle

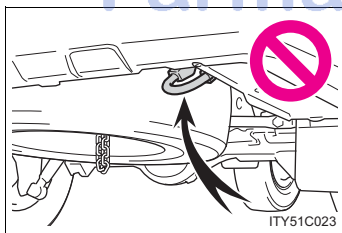

Do not use the rear emergency towing hook.

5-1. Essential information

If you think something is wrong

If you notice any of the following symptoms, your vehicle probably needs adjustment or repair. Contact your Toyota dealer as soon as possible.

■ Visible symptoms

- Fluid leaks under the vehicle
(Water dripping from the air conditioning after use is normal.)
- Flat-looking tires or uneven tire wear
- Engine coolant temperature gauge needle continually points higher than normal
- Engine oil pressure gauge continually points lower than normal
- Voltmeter continually points higher or lower than normal

■ Audible symptoms

- Changes in exhaust sound
- Excessive tire squeal when cornering
- Strange noises related to the suspension system
- Pinging or other noises related to the engine

■ Operational symptoms

- Engine missing, stumbling or running rough
- Appreciable loss of power
- Vehicle pulls heavily to one side when braking
- Vehicle pulls heavily to one side when driving on a level road
- Loss of brake effectiveness, spongy feeling, pedal almost touches the floor

5-1. Essential information Fuel pump shut off system

To minimize the risk of fuel leakage when the engine stalls or an air-bag inflates upon collision, the fuel pump shut off system stops supplying fuel to the engine.

Follow the procedure below to restart the engine after the system is activated.

STEP 1 Turn the “ENGINE START STOP” switch to ACCESSORY mode or OFF.

STEP 2 Restart the engine.

NOTICE

■ Before starting the engine

Inspect the ground under the vehicle.

If you find that fuel has leaked on to the ground, the fuel system has been damaged and is in need of repair. Do not restart the engine.

تلفن شبانه روزی: ۰۲۱-۸۸۸۶۲۰۸۵

FarmaSOS.com

5

When trouble arises

5-2. Steps to take in an emergency

If a warning light turns on or a warning buzzer sounds...

Calmly perform the following actions if any of the warning lights turn on or flash. If a light turns on or flashes, but then turns off, this does not necessarily indicate a malfunction in the system.

However, if this continues to occur, have the vehicle inspected by your Toyota dealer.

Stop the vehicle immediately. Continuing to drive the vehicle may be dangerous.

The following warning indicates a possible problem in the brake system. Immediately stop the vehicle in a safe place and contact your Toyota dealer.

Warning light	Warning light/Details
	Brake system warning light (warning buzzer)* <ul style="list-style-type: none">• Low brake fluid• Malfunction in the brake system This light also comes on when the parking brake is not released. If the light turns off after the parking brake is fully released, the system is operating normally.

*:Parking brake engaged warning buzzer:

A buzzer will sound if the vehicle is driven at a speed of approximately 3 mph (5 km/h) or more.



Stop the vehicle immediately.

The following warning indicates the possibility of damage to the vehicle that may lead to an accident. Immediately stop the vehicle in a safe place and contact your Toyota dealer.



Warning light	Warning light/Details
	Charging system warning light Indicates a malfunction in the vehicle's charging system.

Have the vehicle inspected by your Toyota dealer immediately.

Failing to investigate the cause of the following warnings may lead to the system operating abnormally and possibly cause an accident. Have the vehicle inspected by your Toyota dealer immediately.

Warning light	Warning light/Details
	Malfunction indicator lamp Malfunction in: <ul style="list-style-type: none"> • The emission control system; • The electronic engine control system; • The electronic throttle control system; or • The electronic automatic transmission control system.
	SRS warning light Malfunction in: <ul style="list-style-type: none"> • The SRS airbag system; • The front passenger occupant classification system; or • The seat belt pretensioner system.

5-2. Steps to take in an emergency





Warning light	Warning light/Details
	ABS warning light Malfunction in: <ul style="list-style-type: none"> • The Multi Terrain ABS; or • The brake assist system.
 (Comes on or flashes)	Pre-collision system warning light (if equipped) Indicates: <ul style="list-style-type: none"> • Malfunction in the pre-collision system if the light comes on. • The system cannot temporarily be used if the light flashes. (→P. 626)
	Slip indicator light Indicates a malfunction in: <ul style="list-style-type: none"> • Vehicle stability control; • Trailer Sway Control; • Active Traction Control; • The hill-start assist control system; • Crawl Control system; or • Multi-terrain Select.

Have the malfunction repaired immediately.



After taking the specified steps to correct the suspected problem, check that the warning light turns off.

Warning light	Warning light/Details	Correction procedure
	Open door warning light (warning buzzer)*1 A door is not fully closed.	Check that all doors are closed.

5-2. Steps to take in an emergency

Warning light	Warning light/Details	Correction procedure
	Driver's seat belt reminder light (warning buzzer)*2 Warns the driver to fasten his/her seat belt.	Fasten the seat belt.
 *3 PASSENGER  *4 PASSENGER (On the center cluster)	Front passenger's seat belt reminder light (warning buzzer)*2 Warns the front passenger to fasten his/her seat belt.	Fasten the seat belt.
	Tire pressure warning light	
	When the light comes on: Low tire inflation pressure such as • Natural causes (→P. 614) • Flat tire (→P. 635)	Adjust the tire inflation pressure (including the spare tire) to the specified level. The light will turn off after a few minutes. In case the light does not turn off even if the tire inflation pressure is adjusted, have the system checked by your Toyota dealer.
	When the light comes on after blinking for 1 minute: Malfunction in the tire pressure warning system. (→P. 616)	Have the system checked by your Toyota dealer.
	Unengaged "Park" warning light The transmission "Park" mechanism is not engaged.	Shift four-wheel drive control to "H4" or "L4". (→P. 240)

5-2. Steps to take in an emergency

Warning light	Warning light/Details	Correction procedure
	Low fuel level warning light Indicates that remaining fuel is about 4.0 gal. (15.0 L, 3.3 Imp. gal.) or less.	Refuel the vehicle.
	Master warning light A buzzer sounds and the warning light comes on and flashes to indicate that the master warning system has detected a malfunction.	→P. 619

*1: Open door warning buzzer:

The open door warning buzzer sounds to alert one or more of the doors is not fully closed (with the vehicle having reached a speed of 3 mph [5 km/h]).

*2: Driver's seat belt buzzer:

The driver's seat belt buzzer sounds to alert the driver that his or her seat belt is not fastened. Once the engine switch is turned to IGNITION ON mode, the buzzer sounds for 6 seconds. If the vehicle reaches a speed of 12 mph (20 km/h), the buzzer sounds once. If the seat belt is still unfastened after 30 seconds, the buzzer will sound intermittently for 10 seconds. Then, if the seat belt is still unfastened, the buzzer will sound in a different tone for 20 more seconds.

Front passenger's seat belt buzzer:

The front passenger's seat belt buzzer sounds to alert the front passenger that his or her seat belt is not fastened. The buzzer sounds once if the vehicle reaches a speed of 12 mph (20 km/h). If the seat belt is still unfastened after 30 seconds, the buzzer will sound intermittently for 10 seconds. Then, if the seat belt is still unfastened, the buzzer will sound in a different tone for 20 more seconds.

*3: Vehicles with navigation system

*4: Vehicles without navigation system

■ If the malfunction indicator lamp comes on while driving

First check the following:

- Is the fuel empty?
If it is, fill the fuel tank immediately.
- Is the fuel tank cap loose?
If it is, tighten it securely.

The malfunction indicator lamp will go off after taking several driving trips. If the malfunction indicator lamp does not go off even after several trips, contact your Toyota dealer as soon as possible.

■ If the low speed four-wheel drive indicator light or the center differential lock indicator light blinks

Take the specified steps. (→P. 243)

If the brake system warning light or the malfunction indicator light also comes on, or the low speed four-wheel drive indicator light or the center differential lock indicator light continues to blink after taking the specified steps, there may be a malfunction in the engine, the brake system or the four-wheel drive system. In this case, you may not be able to transfer between "H4" and "L4" modes, and the center differential lock may not be able to be locked or unlocked. Have the vehicle inspected by your Toyota dealer immediately.

■ Front passenger detection sensor and passenger seat belt reminder

- If luggage is placed on the front passenger seat, the front passenger detection sensor may cause the warning light to flash, even if a passenger is not sitting in the seat.
- If a cushion is placed on the seat, the sensor may not detect a passenger, and the warning light may not operate properly.

5-2. Steps to take in an emergency

■ SRS warning light

This warning light system monitors the following:

- The airbag sensor assembly
- Front impact sensors
- Side impact sensors (rear)
- Side impact sensors (front door)
- Safing sensor (rear)
- The driver's seat belt buckle switch
- The driver's seat position sensor
- Front passenger's seat belt buckle switch
- The airbags
- The interconnecting wiring and power sources
- The front passenger occupant classification system
- "AIR BAG ON" and "AIR BAG OFF" indicator lights
- The seat belt pretensioners
- The "RSCA OFF" indicator light

■ Changing the engine oil

Make sure to reset oil change system

■ When the tire pressure warning light comes on

Check the tire inflation pressure and adjust to the appropriate level. Pushing the tire pressure warning reset switch does not turn off the tire pressure warning light.

■ The tire pressure warning light may turn on due to natural causes

The tire pressure warning light may turn on due to natural causes such as natural air leaks or tire inflation pressure changes caused by temperature. In this case, adjusting the tire inflation pressure will turn off the warning light (after a few minutes).

■ When a tire is replaced with a spare tire

The spare tire is also equipped with the tire pressure warning valve and transmitter. The tire pressure warning light will turn on if the tire inflation pressure of the spare tire is low. If a tire goes flat, even though the flat tire is replaced with the spare tire, the tire pressure warning light does not turn off. Replace the spare tire with the repaired tire and adjust the proper tire inflation pressure. The tire pressure warning light will turn off after a few minutes.

■ If the tire pressure warning system is inoperative

The tire pressure warning system will be disabled in the following conditions:

(When the condition becomes normal, the system will work properly.)

- If tires not equipped with tire pressure warning valves and transmitters are used.
- If the ID code on the tire pressure warning valves and transmitters is not registered in the tire pressure warning computer.
- If the tire inflation pressure is 73 psi (500 kPa, 5.1 kgf/cm² or bar) or higher.

The tire pressure warning system may be disabled in the following conditions:

(When the condition becomes normal, the system will work properly.)

- If electronic devices or facilities using similar radio wave frequencies are nearby.
- If a radio set at similar frequencies is in use in the vehicle.
- If a window tint that affects the radio wave signals is installed.
- If there is a lot of snow or ice on the vehicle, in particular around the wheels or wheel housings.
- If non-genuine Toyota wheels are used. (Even if you use Toyota wheels, the tire pressure warning system may not work properly with some types of tires.)
- If tire chains are used.
- If the spare tire is in a location subject to poor radio wave signal reception.
- If a large metallic object which can interfere with signal reception is put in the luggage compartment.

5-2. Steps to take in an emergency

■ If the tire pressure warning light frequently comes on after blinking for 1 minute

If the tire pressure warning light frequently comes on after blinking for 1 minute when the "ENGINE START STOP" switch is turned to IGNITION ON mode, have it checked by Toyota dealer.

⚠ CAUTION

■ If the tire pressure warning light comes on

Be sure to observe the following precautions. Failure to do so could cause loss of vehicle control and result in death or serious injury.

- Stop your vehicle in a safe place as soon as possible. Adjust the tire inflation pressure immediately.
- If the tire pressure warning light comes on even after tire inflation pressure adjustment, it is probable that you have a flat tire. Check the tires. If the tire is flat, change to the spare tire and have the flat tire repaired by the nearest Toyota dealer.
- Avoid abrupt maneuvering and braking. If the vehicle tires deteriorate, you could lose control of the steering wheel or the brakes.

■ If a blowout or sudden air leakage should occur

The tire pressure warning system may not activate immediately.

FarmaSOS.com

 CAUTION**■ Maintenance of the tires**

Each tire, including the spare (if provided), should be checked monthly when cold and inflated to the inflation pressure recommended by the vehicle manufacturer on the vehicle placard or tire inflation pressure label (tire and load information label). (If your vehicle has tires of a different size than the size indicated on the vehicle placard or tire inflation pressure label [tire and load information label], you should determine the proper tire inflation pressure for those tires.)

As an added safety feature, your vehicle has been equipped with a tire pressure monitoring system (TPMS-tire pressure warning system) that illuminates a low tire pressure telltale (tire pressure warning light) when one or more of your tires is significantly under-inflated. Accordingly, when the low tire pressure telltale (tire pressure warning light) illuminates, you should stop and check your tires as soon as possible, and inflate them to the proper pressure. Driving on a significantly under-inflated tire causes the tire to overheat and can lead to tire failure. Under-inflation also reduces fuel efficiency and tire tread life, and may affect the vehicle's handling and stopping ability.

Please note that the TPMS (tire pressure warning system) is not a substitute for proper tire maintenance, and it is the driver's responsibility to maintain correct tire pressure, even if under-inflation has not reached the level to trigger illumination of the TPMS low tire pressure telltale (tire pressure warning light).

5-2. Steps to take in an emergency

CAUTION

Your vehicle has also been equipped with a TPMS (tire pressure warning system) malfunction indicator to indicate when the system is not operating properly. The TPMS (tire pressure warning system) malfunction indicator is combined with the low tire pressure telltale (tire pressure warning light). When the system detects a malfunction, the telltale will flash for approximately one minute and then remain continuously illuminated. This sequence will continue upon subsequent vehicle start-ups as long as the malfunction exists. When the malfunction indicator is illuminated, the system may not be able to detect or signal low tire pressure as intended.

TPMS (tire pressure warning system) malfunctions may occur for a variety of reasons, including the installation of replacement or alternate tires or wheels on the vehicle that prevent the TPMS (tire pressure warning system) from functioning properly. Always check the TPMS (tire pressure warning system) malfunction telltale after replacing one or more tires or wheels on your vehicle to ensure that the replacement or alternate tires and wheels allow the TPMS (tire pressure warning system) to continue to function properly.

NOTICE

■ **Precaution when installing a different tire**

A tire of a different specification or maker may cause the tire pressure warning system to not operate properly.

5-2. Steps to take in an emergency If a warning message is displayed

The multi-information display shows warnings of system malfunctions, incorrectly performed operations, or shows messages that indicate a need for maintenance.

If a warning is shown on the multi-information display, stay calm and perform the following actions:

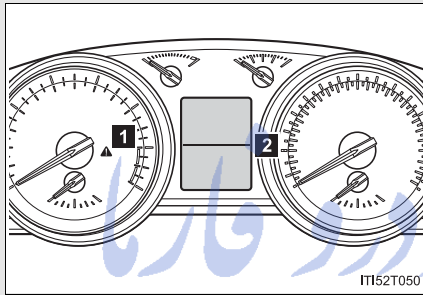

1 Master warning light

The master warning light also comes on or flashes in order to indicate that a message is currently being displayed on the multi-information display.

2 Multi-information display

If any of the warning messages is shown again after its correction procedure has been performed, contact your Toyota dealer.







تلفن شبانه روزی: ۰۲۱-۸۸۶۲۰۸۵







FarmaSOS.com

5-2. Steps to take in an emergency

Have the vehicle inspected immediately.

Failure to investigate the cause of the following warnings may lead to the system operating abnormally and possibly cause an accident. Have the vehicle inspected by your Toyota dealer immediately.

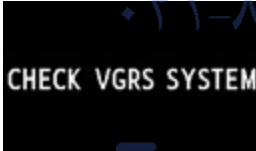





Warning message	Details
 	<p>Indicates a malfunction in the automatic transmission system A buzzer also sounds.</p>
 	<p>Indicates a malfunction in the steering lock system A buzzer also sounds.</p>
   (If equipped)	<p>Indicates a malfunction in the pre-collision system A buzzer also sounds.</p>

Warning message	Details
 	<p>Indicates a malfunction in the intuitive parking assist The site of malfunction is shown flashing on the display.</p>
 	<p>Indicates a malfunction in the cruise control system Press the "ON-OFF" button once to deactivate the system, and then press the button again to reactivate the system.</p> <p>Indicates a malfunction in the dynamic radar cruise control system (if equipped) Press the "ON-OFF" button once to deactivate the system, and then press the button again to reactivate the system.</p>
  <p>(If equipped)</p>	<p>Indicates a malfunction in the VGRS A buzzer also sounds.</p>





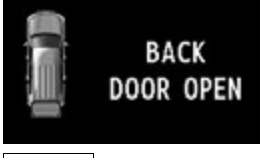

5-2. Steps to take in an emergency

Follow the correction procedures.





After taking the specified steps to correct the suspected problem, check that the warning message goes off.

Warning message	Details	Correction procedure
	<p>Indicates that one or more of the doors is not fully closed</p> <p>The system also indicates which doors are not fully closed.</p> <p>If the vehicle reaches a speed of 3 mph (5 km/h),  flashes and a buzzer sounds to indicate that the door(s) are not yet fully closed.</p>	<p>Make sure that all the doors are closed.</p>
		
		
		
		
		

5-2. Steps to take in an emergency

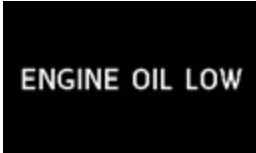

Warning message	Details	Correction procedure
  (Flashes)	<p>Indicates that the moon roof is not fully closed (with the “ENGINE START STOP” switch off, and the driver’s door open)</p>	<p>Close the moon roof.</p>
  (Flashes)	<p>Indicates, if the vehicle reaches a speed of 3 mph (5 km/h), that the parking brake is still engaged.</p>	<p>Release the parking brake.</p>
 	<p>Indicates that the automatic transmission fluid temperature is too high A buzzer also sounds.</p>	<p>Stop the vehicle in a safe place, shift the shift lever to “P” and wait until the light goes off. If the light goes off, you may start the vehicle again. If the light does not go off, contact your Toyota dealer.</p>

5-2. Steps to take in an emergency

Warning message	Details	Correction procedure
 	<p>Indicates that engine oil level is low A buzzer also sounds.</p>	<p>Check the level of engine oil, and add if necessary. This message may appear if the vehicle is stopped on a slope. Move the vehicle to a level surface and check to see if the message disappears.</p>
	<p>Indicates that the washer fluid level is low</p>	<p>Add washer fluid</p>
 	<p>Low tire inflation pressure</p>	<p>Check the tire inflation pressure, and adjust to the appropriate level.</p>





FarmaSOS.com

5-2. Steps to take in an emergency



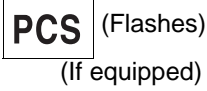

Warning message	Details	Correction procedure
	<p>Indicates that all maintenance according to the driven distance on the maintenance schedule* should be performed soon.</p> <p>Comes on approximately 4500 miles (7200 km) after the maintenance data has been reset.</p>	If necessary, perform maintenance.
	<p>Indicates that all maintenance is required to correspond to the driven distance on the maintenance schedule*.</p> <p>Comes on approximately 5000 miles (8000 km) after the maintenance data has been reset. (The indicator will not work properly unless the maintenance data has been reset.)</p>	

*: Refer to the separate “Scheduled Maintenance Guide” or “Owner’s Manual Supplement” for the maintenance interval applicable to your vehicle.

5-2. Steps to take in an emergency

Warning message	Details	Correction procedure
 	<p>Indicates that the pre-collision system is not currently functional because the grille or the sensor is dirty</p> <p>Indicates that the pre-collision system is not currently functional due to overheating.</p>	<ul style="list-style-type: none"> • Check the grille and the sensor and clean them if they are dirty. • In case of overheating, the system will become functional once the system cools down.
 	<p>Indicates that intuitive parking assist is dirty or covered with ice</p>	<p>Clean the sensor.</p>
 	<p>Indicates that remaining fuel is about 4.0 gal. (15.0 L, 3.3 Imp. gal.) or less</p>	<p>Refuel the vehicle.</p>



5-2. Steps to take in an emergency

Warning message	Details	Correction procedure
  (If equipped)	Indicates that the dynamic radar cruise control sensor is dirty or covered with ice	Clean the sensor.
  (If equipped)	Indicates that the dynamic radar cruise control system is unable to judge vehicle-to-vehicle distance	<ul style="list-style-type: none"> • Switch driving mode to either normal or power. • If the windshield wipers are on, turn them off or set them to either intermittent or slow mode.
 (Flashes) (If equipped)	Indicates that your vehicle is nearing the vehicle ahead (in vehicle-to-vehicle distance control mode) A buzzer also sounds.	Slow the vehicle by applying the brakes.



5-2. Steps to take in an emergency

Have the malfunction repaired immediately.

After taking the specified steps to correct the suspected problem, check that the warning message and light go off.

Interior buzzer	Exterior buzzer	Warning message	Details	Correction procedure
Once	3 times	  (Flashes)	<p>The electronic key was carried outside the vehicle and a door other than the driver's door was opened and closed while the "ENGINE START STOP" switch was in a mode other than off.</p> <p>The driver's door was opened and closed while the electronic key was not in the vehicle, the shift lever was in "P" and the "ENGINE START STOP" switch was not turned off.</p>	<p>Bring the electronic key back into the vehicle.</p> <p>Turn the "ENGINE START STOP" switch off or bring the electronic key back into the vehicle.</p>

5-2. Steps to take in an emergency

Interior buzzer	Exterior buzzer	Warning message	Details	Correction procedure
Once	—	  (Flashes)	<p>An attempt was made to start the engine without the electronic key being present, or the electronic key was not functioning normally.</p> <p>An attempt was made to drive when the regular key was not inside the vehicle.</p>	<p>Start the engine with the electronic key present*.</p>

*: If the engine does not start when the electronic key is inside the vehicle, the electronic key battery may be depleted or there may be difficulty receiving signal from the key. (→P. 653)





تلفن شبانه روزی: ۰۲۱-۸۸۶۲۰۸۵

FarmaSOS.com

5



When trouble arises

5-2. Steps to take in an emergency

Interior buzzer	Exterior buzzer	Warning message	Details	Correction procedure
Continuous	—	  (Flashes)	The driver's door was opened when the shift lever was not in "P" and the "ENGINE START STOP" switch was not turned off.	Shift the shift lever to "P".
Continuous	Continuous	  (Displayed alternately)  (Flashes)	The driver's door was opened and closed while the electronic key was not in the vehicle, the shift lever was not in "P" and the "ENGINE START STOP" switch was not turned off.	<ul style="list-style-type: none"> • Shift the shift lever to "P". • Bring the electronic key back into the vehicle.

FarmaSOS.com



5-2. Steps to take in an emergency

Interior buzzer	Exterior buzzer	Warning message	Details	Correction procedure
Once	—	<p>DEPRESS BRAKE PEDAL, TOUCH ENGINE SWITCH WITH KEY</p>  (Flashes)	<ul style="list-style-type: none"> • When the doors were unlocked with the mechanical key and then the “ENGINE START STOP” switch was pressed, the electronic key could not be detected in the vehicle. • The electronic key could not be detected in the vehicle even after the “ENGINE START STOP” switch was pressed two consecutive times. 	Touch the electronic key to the “ENGINE START STOP” switch while depressing the brake pedal.
Once	—	<p>KEY BATTERY LOW</p> 	The electronic key has a low battery.	Replace the electronic key battery. (→P. 563)

5





When trouble arises

5-2. Steps to take in an emergency

Interior buzzer	Exterior buzzer	Warning message	Details	Correction procedure
Once	—	<p>DEPRESS BRAKE PEDAL AND PUSH ENGINE SWITCH TO START</p>  (Flashes)	A door was opened and closed with the “ENGINE START STOP” switch turned off and then the “ENGINE START STOP” switch was put in ACCESSORY mode twice without the engine being started.	Press the “ENGINE START STOP” switch while depressing the brake pedal.
Once	—	<p>STEERING LOCK ACTIVE</p>  (Flashes)	The steering lock could not be released within 3 seconds of the “ENGINE START STOP” switch being pressed.	Press the “ENGINE START STOP” switch while depressing the brake pedal and moving the steering wheel left and right.

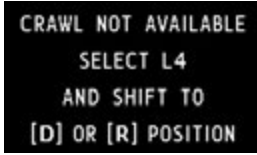
Other messages

If the following message is displayed, take appropriate action and confirm that the message has disappeared. (→P. 245)

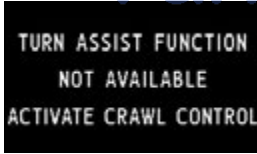
Message	Correction procedure
	<p>Select the four-wheel drive control switch in L4 and shift the shift lever to “D” or “R”.</p>
	<p>Confirm the operating conditions.</p>
 	<p>Confirm the operating conditions to operate Turn Assist function.</p>
	<p>Turn on the Crawl Control switch to operate Turn Assist function.</p>

5-2. Steps to take in an emergency

■ Warning message in vehicle-to-vehicle distance control mode of the dynamic radar cruise control (if equipped)

In the following cases, the warning message may not be displayed even if vehicle-to-vehicle distance decreases:

- When your vehicle and the vehicle ahead are traveling at the same speed or the vehicle ahead is traveling more quickly than your vehicle
- When the vehicle ahead is traveling at a very low speed
- Immediately after cruise control speed is set
- At the instant the accelerator pedal is depressed

■ Resetting the tire pressure warning data

After adjusting the tire inflation pressure, be sure to initialize the data.
(→P. 545)

If the message remains on, the system may have malfunctioned. Have the vehicle inspected by your Toyota dealer as soon as possible.

تلفن شبانه روزی: ۰۲۱-۸۸۸۶۲۰۸۵

FarmaSOS.com

5-2. Steps to take in an emergency If you have a flat tire

Remove the flat tire and replace it with the spare provided.

■ **Before jacking up the vehicle**

- Stop the vehicle on a hard, flat surface.
- Set the parking brake.
- Shift the shift lever to "P".
- Stop the engine.
- Turn on the emergency flashers.

■ **Location of the spare tire, jack and tools**

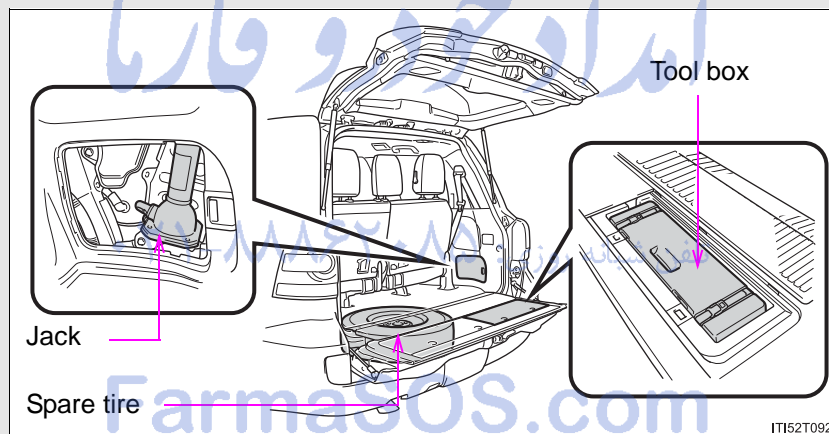

5-2. Steps to take in an emergency

Taking out the jack

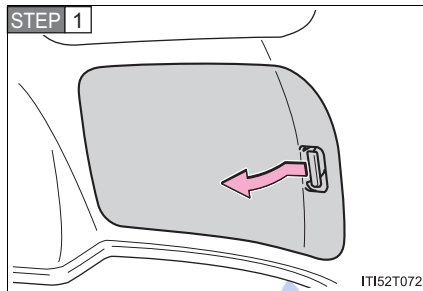

Remove the cover.

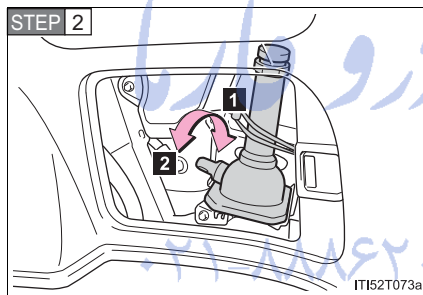

Unhook the rubber band and take out the jack.

1 Loosen

2 Tighten

Loosen and remove the jack.

FarmaSOS.com

Taking out the tool box

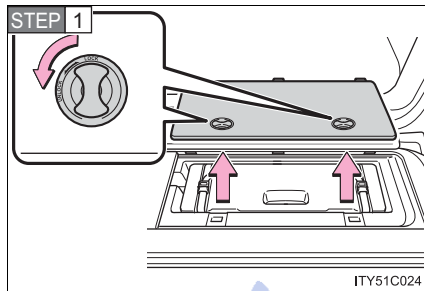

Remove the cover.

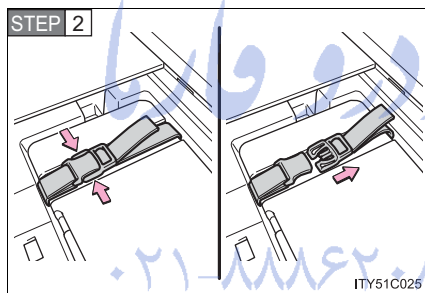

Take out the tool box.

FarmaSOS.com

5-2. Steps to take in an emergency

Taking out the spare tire

STEP 1 Assembling the jack handle.

Remove the jack handle and the jack extension bar from the tool box and assemble by following these steps.

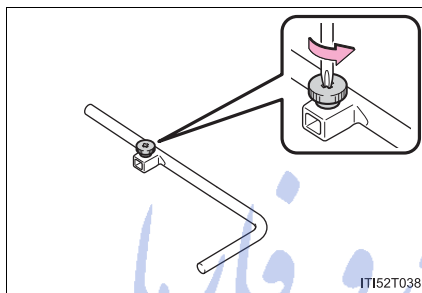

1 Loosen the screw using a screwdriver.

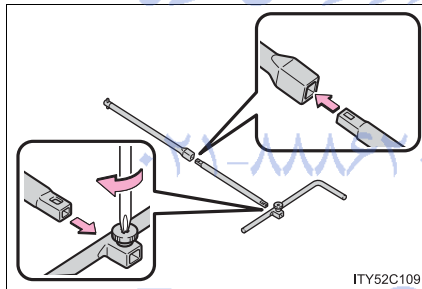

2 Assemble the jack handle and the jack handle extension bar and tighten the screw.

Check that the screw is firmly tightened.

5-2. Steps to take in an emergency

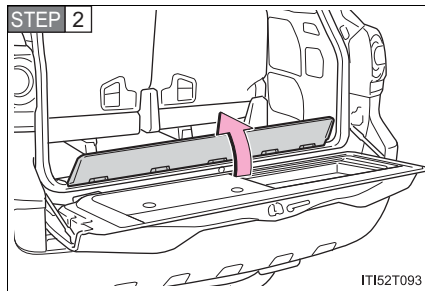

Open the cover.

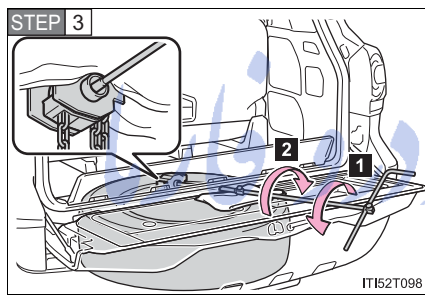

Insert the jack handle extension into the lowering screw.

1 Lower

2 Raise

Place a rag under the jack handle extension to protect the back door.

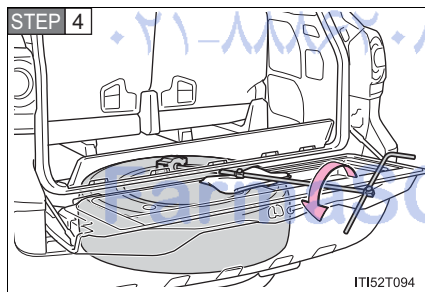

Lower the spare tire completely to the ground.

5

When trouble arises

5-2. Steps to take in an emergency

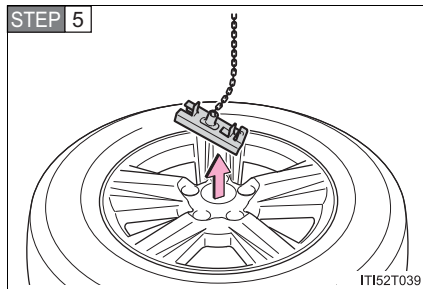

Pull out the spare tire and remove the holding bracket.

Replacing a flat tire

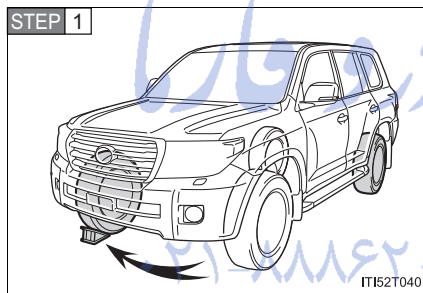

Chock the tires.

	Flat tire	Wheel chock position
Front	Left-hand side	Behind the rear right-hand side tire
	Right-hand side	Behind the rear left-hand side tire
Rear	Left-hand side	In front of the front right-hand side tire
	Right-hand side	In front of the front left-hand side tire

5-2. Steps to take in an emergency

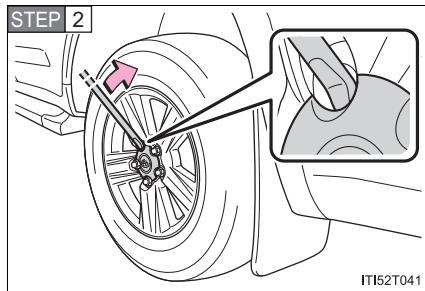

Pry off the wheel ornament, using the beveled end of the wheel ornament remover as shown.

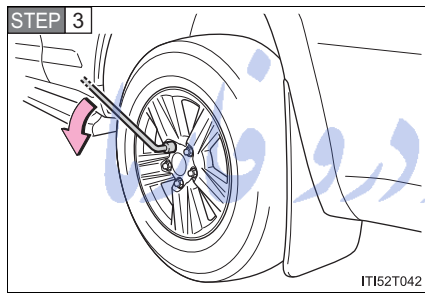

Slightly loosen the wheel nuts (one turn).

تلفن شبانه روزی: ۰۲۱-۸۸۶۲۰۸۵

FarmaSOS.com

5

When trouble arises

5-2. Steps to take in an emergency

STEP 4 Assembling the jack handle.

Remove the jack handle, jack extension bar and jack handle bar from the tool box and assemble by following these steps.

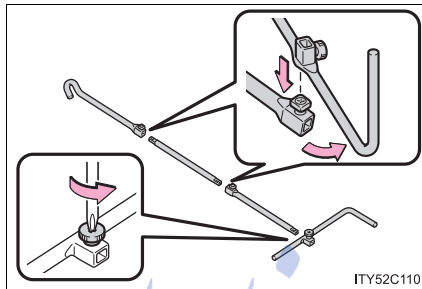

- 1 Loosen the bolts and the screw using either the jack handle or a screwdriver.

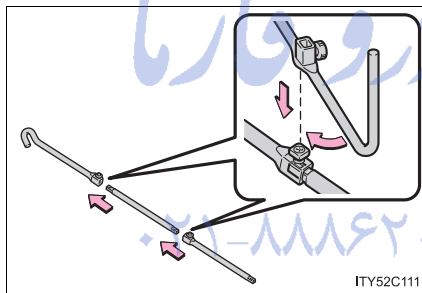

- 2 Assemble the jack handle extension bar and the jack handle bar and tighten the bolts.

Check that the bolts are firmly tightened.

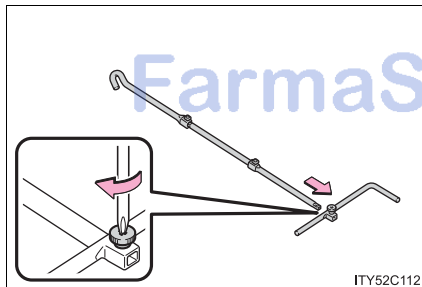

- 3 Assemble the jack handle extension bar and the jack handle and tighten the screw.

Check that the screw is firmly tightened.

5-2. Steps to take in an emergency

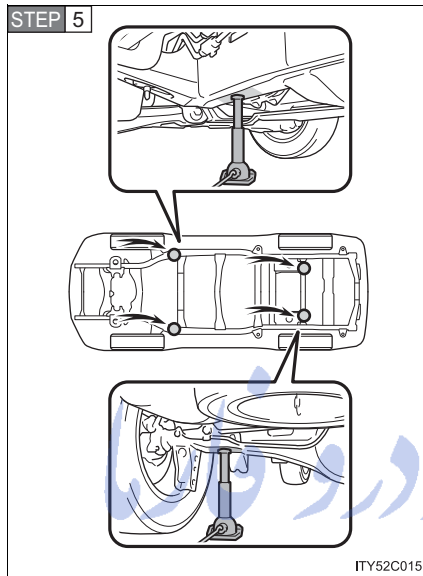

Position the jack at the jack points as shown.

Front - Under the chassis frame side rail

Rear - Under the rear axle housing

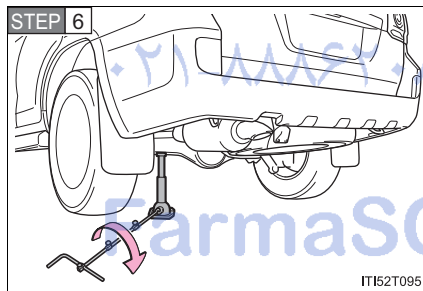

Raise the vehicle until the tire is slightly raised off the ground.

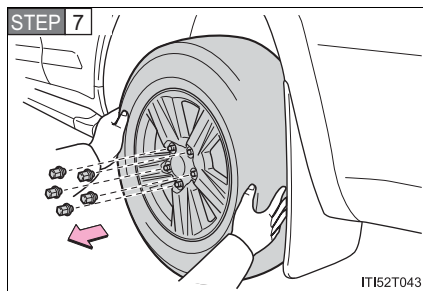

Remove all the wheel nuts and the tire.

When resting the tire on the ground, place the tire so that the wheel design faces up to avoid scratching the wheel surface.

5

When trouble arises

5-2. Steps to take in an emergency

Installing the spare tire

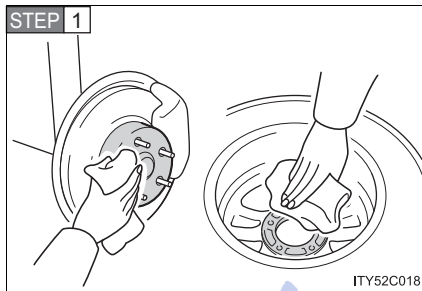

Remove any dirt or foreign matter from the wheel contact surface.

If foreign matter is on the wheel contact surface, the wheel nuts may loosen while the vehicle is in motion, and the tire may come off the vehicle.

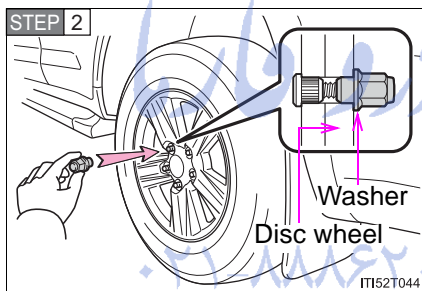

Install the spare tire and loosely tighten each nut by hand to approximately the same amount.

Turn the nut washers until they come into contact with the disc wheel.

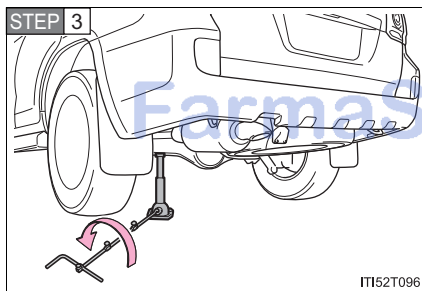

Lower the vehicle.

5-2. Steps to take in an emergency

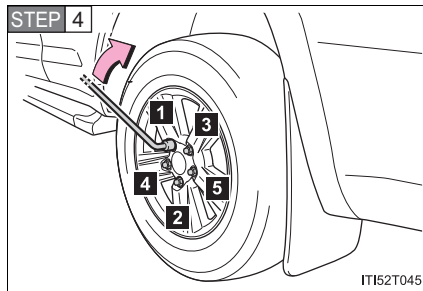

Firmly tighten each nut two or three times in the order shown in the illustration.

Tightening torque:
97 ft•lb (131 N•m, 13.4 kgf•m)

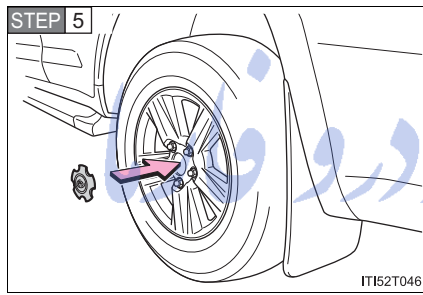

Reinstall the wheel ornament.

Stowing the flat/spare tire, jack and tools

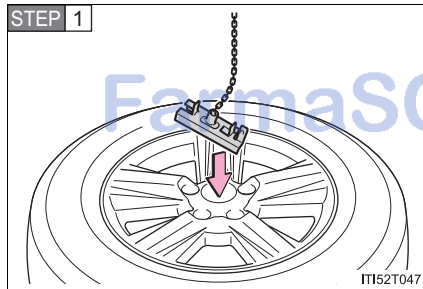

Lay down the tire with the outer side facing up, and install the holding bracket.

STEP 2 Raise the tire.

Pull the tire towards the rear of the vehicle when raising. After raising, visually check that tire is not interfering with components.

STEP 3 Stow the tools and jack securely, and replace all covers.

5

When trouble arises

■ **After completing the tire change**

The tire pressure warning system must be reset. (→P. 545)

 **CAUTION**

■ **Using the tire jack**

Improper use of the tire jack may lead to death or serious injuries due to the vehicle suddenly falling off the jack.

- Do not use the tire jack for any purpose other than replacing tires or installing and removing tire chains.
- Only use the tire jack that comes with this vehicle for replacing a flat tire.
Do not use it on other vehicles, and do not use other tire jacks for replacing tires on this vehicle.
- Always check that the tire jack is securely set to the jack point.
- Do not raise the vehicle while someone is in it.
- When raising the vehicle, do not put an object on or under the jack.
- Do not raise the vehicle to a height greater than that required to replace the tire.
- Use a jack stand if it is necessary to get under the vehicle.
- Do not put any part of your body under the vehicle supported by a jack.
- Do not start or run the engine while your vehicle is supported by the jack.

Take particular care when lowering the vehicle to ensure that no one working on or near the vehicle may be injured.

■ **Using the jack handle**

Tighten all the jack handle bolts securely using a Phillips-head screwdriver, to prevent the extension parts from coming apart unexpectedly.

⚠ CAUTION**■ Replacing a flat tire**

- Observe the following precautions.
Failure to do so may result in serious injury:
 - Lower the spare tire completely to the ground before removing it from under the vehicle.
 - Do not try to remove the wheel ornament by hand. Take due care in handling the ornament to avoid unexpected personal injury.
 - Do not touch the disc wheels or the area around the brakes immediately after the vehicle has been driven.
After the vehicle has been driven the disc wheels and the area around the brakes will be extremely hot. Touching these areas with hands, feet or other body parts while changing a tire, etc. may result in burns.
- Failure to follow these precautions could cause the wheel nuts to loosen and the tire to fall off, resulting in death or serious injury.
 - Have the wheel nuts tightened with a torque wrench to 97 ft•lbf (131 N•m, 13.4 kgf•m) as soon as possible after changing wheels.
 - When installing a tire, only use wheel nuts that have been specifically designed for that wheel.
 - If there are any cracks or deformations in the bolt screws, nut threads or bolt holes of the wheel, have the vehicle inspected by your Toyota dealer.
 - Do not attach a heavily damaged wheel ornament, as it may fly off the wheel while the vehicle is moving.
 - When installing the wheel nuts, be sure to install them with the tapered ends facing inward. (→P. 558)

 NOTICE

■ **Do not drive the vehicle with a flat tire**

Do not continue driving with a flat tire.
Driving even a short distance with a flat tire can damage the tire and the wheel beyond repair.

■ **When stowing the flat tire**

Ensure that there is no object caught between the tire and the vehicle underbody.

■ **When replacing the tires**

When removing or fitting the wheels, tires or the tire pressure warning valve and transmitter, contact your Toyota dealer as the tire pressure warning valve and transmitter may be damaged if not handled correctly.

■ **To avoid damage to the tire pressure warning valves and transmitters**

When a tire is repaired with liquid sealants, the tire pressure warning valve and transmitter may not operate properly. If a liquid sealant is used, contact your Toyota dealer or other qualified service shop as soon as possible. Make sure to replace the tire pressure warning valve and transmitter when replacing the tire. (→P. 545)

FarmaSOS.com

5-2. Steps to take in an emergency If the engine will not start

If the engine still does not start after following the correct starting procedure (→P. 166) or releasing the steering lock (→P. 168), confirm the following points.

■ **The engine will not start when the starter motor operates normally**

One of the following may be the cause of the problem.

- There may not be sufficient fuel in the vehicle's tank.
Refuel the vehicle.
- The engine may be flooded.
Try to restart the engine once more following correct starting procedures. (→P. 166)
- There may be a malfunction in the engine immobilizer system.
(→P. 105)

■ **The starter motor turn over slowly, the interior lights and headlights are dim, or the horn does not sound or sounds at a low volume**

One of the following may be the cause of the problem.

- The battery may be discharged. (→P. 656)
- The battery terminal connections may be loose or corroded.

■ **The starter motor does not turn over**

The engine starting system may be malfunctioning due to an electrical problem such as an open circuit or a blown fuse. However, an interim measure is available to start the engine.
(→P. 650)

5-2. Steps to take in an emergency

■ **The starter motor does not turn over, the interior lights and headlights do not turn on, or the horn does not sound**

One of the following may be the cause of the problem.

- One or both of the battery terminals may be disconnected.
- The battery may be discharged. (→P. 656)
- There may be a malfunction in the steering lock system.

Contact your Toyota dealer if the problem cannot be repaired, or if repair procedures are unknown.

Emergency start function

When the engine does not start, the following steps can be used as an interim measure to start the engine if the “ENGINE START STOP” switch is functioning normally.

STEP 1 Set the parking brake.

STEP 2 Put the shift lever in “P”.

STEP 3 Set the “ENGINE START STOP” switch to ACCESSORY mode.

STEP 4 Press and hold the “ENGINE START STOP” switch about 15 seconds while depressing the brake pedal firmly.

Even if the engine can be started using the above steps, the system may be malfunctioning. Have the vehicle checked by your Toyota dealer.

5-2. Steps to take in an emergency

If the shift lever cannot be shifted from P

If the shift lever cannot be shifted with your foot on the brake, there may be a problem with the shift lock system (a system to prevent accidental operation of the shift lever). Have the vehicle inspected by your Toyota dealer immediately.

The following steps may be used as an emergency measure to ensure that the shift lever can be shifted.

STEP 1 Set the parking brake.

STEP 2 Set the "ENGINE START STOP" switch to the ACCESSORY mode.

STEP 3 Depress the brake pedal.

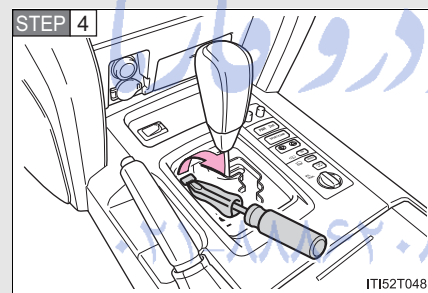

Pry the cover up with a flat-head screwdriver or equivalent.

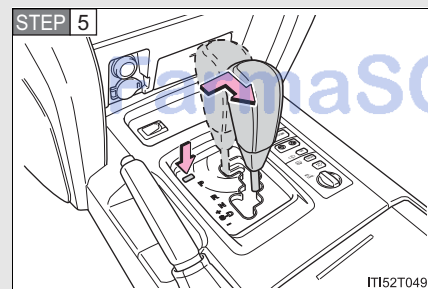

Press the shift lock override button.

The shift lever can be shifted while the button is pressed.

5

When trouble arises

5-2. Steps to take in an emergency
If you lose your keys

New genuine Toyota keys can be made by your Toyota dealer using the other key and the key number stamped on your key number plate.

امداد خودرو فارما

تلفن شبانه روزی: ۰۲۱-۸۸۸۶۲۰۸۵

FarmaSOS.com

5-2. Steps to take in an emergency

If the electronic key does not operate properly

If communication between the electronic key and vehicle is interrupted (→P. 32) or the electronic key cannot be used because the battery is depleted, the smart key system and wireless remote control cannot be used. In such cases, the doors can be opened or the engine can be started by following the procedure below.

Locking and unlocking the doors and key linked functions

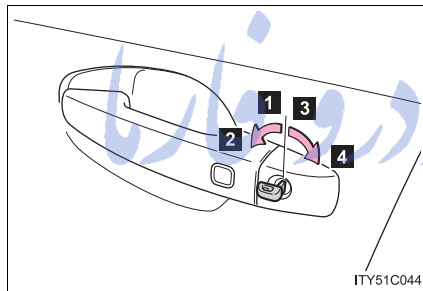

Using the mechanical key (→P. 30) in order to perform the following operations.

- 1** Locks all doors
- 2** Closes the windows/moon roof (turn and hold)*
- 3** Unlocks all doors
Turning the key rearward unlocks the driver's door. Turning the key once again unlocks the other doors.
- 4** Opens the windows/moon roof (turn and hold)*

*: This setting must be customized at your Toyota dealer.

5

When trouble arises

5-2. Steps to take in an emergency

Starting the engine

STEP 1 Shift the shift lever to “P” and apply the brakes.

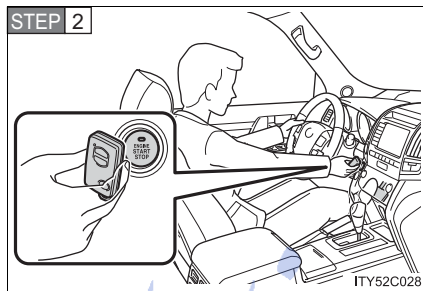

Touch the Toyota emblem side of the electronic key to the “ENGINE START STOP” switch.

An alarm will sound to indicate that the start function cannot detect the electronic key that is touched to the “ENGINE START STOP” switch if any of the doors is opened and closed while the key is touched to the switch.

STEP 3 Press the “ENGINE START STOP” switch within 10 seconds after the buzzer sounds, keeping the brake pedal depressed.

In the event that the “ENGINE START STOP” switch cannot be operated, contact your Toyota dealer.

تلفن شبانه روزی: ۰۲۱-۸۸۶۲۰۸۵

FarmaSOS.com

■ **Stopping the engine**

Shift the shift lever to “P” and press the “ENGINE START STOP” switch as you normally do when stopping the engine.

■ **Replacing the key battery**

As this above procedure is a temporary measure, it is recommended that the electronic key battery be replaced immediately when the battery depletes. (→P. 563)

■ **Alarm**

Using the mechanical key to lock the doors will not set the alarm system. If a door is unlocked using the mechanical key when the alarm system is set, the alarm may be triggered. (→P. 107)

■ **Changing “ENGINE START STOP” switch modes**

Within 10 seconds of the buzzer sounding, release the brake pedal and press the “ENGINE START STOP” switch. Modes can be changed each time the switch is pressed. (→P. 167)

تلفن شبانه روزی: ۰۲۱-۸۸۶۲۰۸۵

FarmaSOS.com

5-2. Steps to take in an emergency If the battery is discharged

The following procedures may be used to start the engine if the battery is discharged.

You can also call your Toyota dealer or qualified repair shop.

If you have a set of jumper (or booster) cables and a second vehicle with a 12 volt battery, you can jump start your Toyota following the steps below.

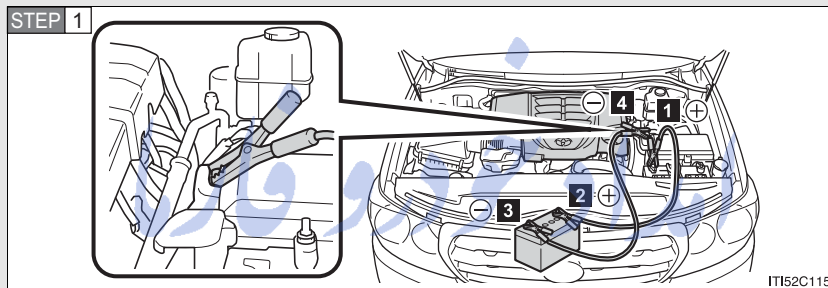

Connecting the jumper cables.

- 1 Positive (+) battery terminal on your vehicle.
 - 2 Positive (+) battery terminal on the second vehicle.
 - 3 Negative (-) battery terminal on the second vehicle.
 - 4 Connect the jumper cable to ground on your vehicles as shown in the illustration.
- STEP 2 Start the engine of the second vehicle. Increase the engine speed slightly and maintain at that level for approximately 5 minutes to recharge the battery of your vehicle.

STEP 3 Open and close any of the doors with the “ENGINE START STOP” switch off.

STEP 4 Maintain the engine speed of the second vehicle and start your vehicle's engine.

STEP 5 Once the vehicle's engine has started, remove the jumper cables in the exact reverse order in which they were connected.

Once the engine starts, have the vehicle checked at your Toyota dealer as soon as possible.

■ Starting the engine when the battery is discharged

The engine cannot be started by push-starting.

■ Avoiding a discharged battery

- Turn off the headlights and the audio system while the engine is off.
- Turn off any unnecessary electrical components when the vehicle is running at a low speed for an extended period, such as in heavy traffic, etc.

■ Charging the battery

The electricity stored in the battery will discharge gradually even when the vehicle is not in use, due to natural discharge and the draining effects of certain electrical appliances. If the vehicle is left for a long time, the battery may discharge, and the engine may be unable to start. (The battery recharges automatically during driving.)

■ When the battery is removed or discharged

Make sure the key is not inside the vehicle when recharging or replacing the battery. The key may be locked in the vehicle if the alarm is activated.

(→P. 109)

5-2. Steps to take in an emergency

CAUTION

■ **Avoiding battery fires or explosions**

Observe the following precautions to prevent accidentally igniting the flammable gas that may be emitted from the battery.

- Make sure the jumper cable is connected to the correct terminal and that it is not unintentionally in contact with any part other than the intended terminal.
- Do not allow the jumper cables to come into contact with the “+” and “-” terminals.
- Do not allow open flame or use matches, cigarette lighters or smoke near the battery.

■ **Battery precautions**

The battery contains poisonous and corrosive acidic electrolyte, while related parts contain lead and lead compounds. Observe the following precautions when handling the battery:

- When working with the battery, always wear safety glasses and take care not to allow any battery fluids (acid) to come into contact with skin, clothing or the vehicle body.
- Do not lean over the battery.
- If the battery fluid comes into contact with the skin or eyes, immediately wash the affected area with water and seek medical attention. Place a wet sponge or cloth over the affected area until medical attention can be received.
- Always wash your hands after handling the battery support, terminals, and other battery-related parts.
- Do not allow children near the battery.

NOTICE

■ **When handling jumper cables**

Be careful that the jumper cables do not become tangled in the cooling fan or any of the belts when connecting or disconnecting them.

5-2. Steps to take in an emergency If your vehicle overheats

The following may indicate that your vehicle is overheating.

- The needle of the engine coolant temperature gauge (→P. 179) enters the red zone or a loss of engine power is experienced. (For example, the vehicle speed does not increase.)
- Steam comes out from under the hood.

Correction procedures

STEP 1 Stop the vehicle in a safe place and turn off the air conditioning system, and then stop the engine.

STEP 2 If you see steam:
Carefully lift the hood after the steam subsides.

If you do not see steam:
Carefully lift the hood.

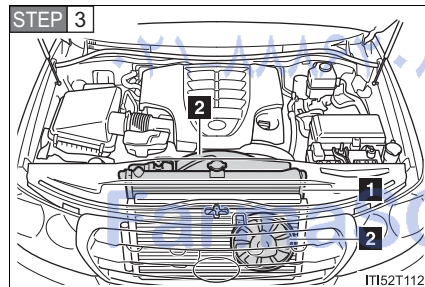

After the engine has cooled down sufficiently, inspect the hoses and radiator core (radiator) for any leaks.

- 1** Radiator
- 2** Cooling fans

If a large amount of coolant leaks, immediately contact your Toyota dealer.

5

When trouble arises

5-2. Steps to take in an emergency

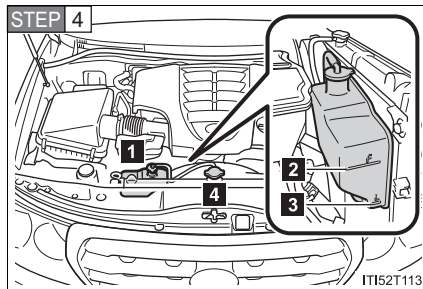

The coolant level is satisfactory if it is between the “F” and “L” lines on the reservoir.

- 1 Reservoir
- 2 “F”
- 3 “L”
- 4 Radiator cap

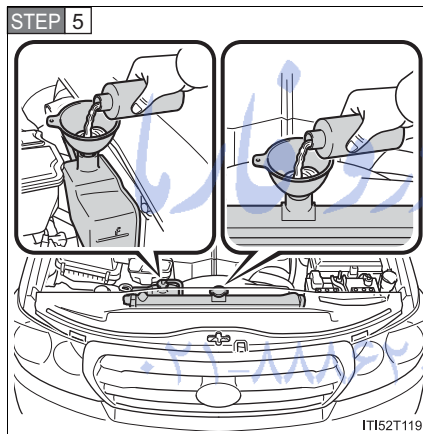

Add coolant if necessary.
(→P. 530)

Water can be used in an emergency if coolant is unavailable.

STEP 6 Start the engine and turn the air conditioning system on to check that the radiator cooling fans operate and to check for coolant leaks from the radiator or hoses.

The fans operate when the air conditioning system is turned on immediately after a cold start. Confirm that the fans are operating by checking the fan sound and air flow. If it is difficult to check these, turn the air conditioning system on and off repeatedly.
(The fans may not operate in freezing temperatures.)

STEP 7 If the fans are not operating:

Stop the engine immediately and contact your Toyota dealer.

If the fans are operating:

Have the vehicle inspected at the nearest Toyota dealer.

 CAUTION

■ **To prevent an accident or injury when inspecting under the hood of your vehicle**

- If steam is seen coming from under the hood, do not open the hood until the steam has subsided. The engine compartment may be very hot, causing serious injury such as burns.
- Keep hands and clothing (especially a tie, a scarf or a muffler) away from the fans and belts. Failure to do so may cause the hands or clothing to be caught, resulting in serious injury.
- Do not loosen the radiator cap or the coolant reservoir cap while the engine and radiator are hot.
Serious injury, such as burns, may result from hot coolant and steam released under pressure.

 NOTICE

■ **When adding engine coolant**

Wait until the engine has cooled down before adding engine coolant. When adding coolant, do so slowly. Adding cool coolant to a hot engine too quickly can cause damage to the engine.

■ **To prevent damage to the cooling system**

Observe the following precautions:

- Avoid contaminating the coolant with foreign matter (such as sand or dust etc.).
- Do not use any coolant additives.

5-2. Steps to take in an emergency If the vehicle becomes stuck

Carry out the following procedures if the tires spin or the vehicle becomes stuck in mud, dirt, or snow.

- STEP 1** Stop the engine. Set the parking brake and shift the shift lever to "P".
- STEP 2** Remove the mud, snow or sand from around the rear wheels.
- STEP 3** Place wood, stones or some other material under the rear wheels to help provide traction.
- STEP 4** Restart the engine.
- STEP 5** Shift the shift lever to "D" or "R" position and release the parking brake. Then, while exercising caution, depress the accelerator pedal.

■ When it is difficult to free the vehicle

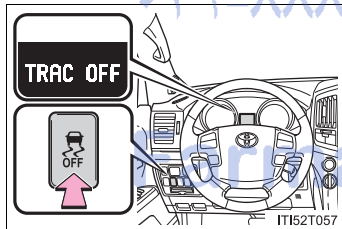

Press  to turn off Active TRAC.

⚠ CAUTION**■ When attempting to free a stuck vehicle**

If you choose to push the vehicle back and forth to free it, make sure the surrounding area is clear, to avoid striking other vehicles, objects or people. The vehicle may also lunge forward or lunge back suddenly as it becomes free. Use extreme caution.

■ When shifting the shift lever

Be careful not to shift the shift lever with the accelerator pedal depressed. This may lead to unexpected rapid acceleration of the vehicle that may cause an accident resulting in death or serious injury.

⚠ NOTICE**■ To avoid damage to the transmission and other components**

- Avoid spinning the rear wheels and depressing the accelerator pedal more than necessary.
- If the vehicle remains stuck even after these procedures are performed, the vehicle may require towing to be freed.

FarmaSOS.com

5-2. Steps to take in an emergency

If your vehicle has to be stopped in an emergency

Only in an emergency, such as if it becomes impossible to stop the vehicle in the normal way, stop the vehicle using the following procedure:

STEP 1 Steadily step on the brake pedal with both feet and firmly depress it.

Do not pump the brake pedal repeatedly as this will increase the effort required to slow the vehicle.

STEP 2 Shift the shift lever to “N”.

► If the shift lever is shifted to “N”

STEP 3 After slowing down, stop the vehicle in a safe place by the road.

STEP 4 Stop the engine.

► If the shift lever cannot be shifted to “N”

STEP 3 Keep depressing the brake pedal with both feet to reduce vehicle speed as much as possible.

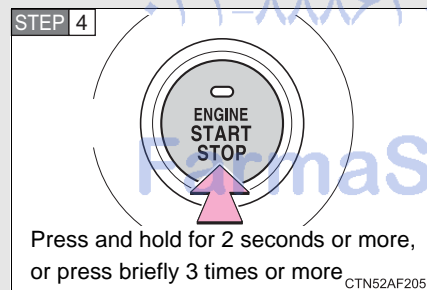

To stop the engine, press and hold the “ENGINE START STOP” switch for 2 consecutive seconds or more, or press it briefly 3 times or more in succession.

STEP 5 Stop the vehicle in a safe place by the road.

 CAUTION

■ **If the engine has to be turned off while driving**

Power assist for the brakes and steering wheel will be lost, making the brake pedal harder to depress and the steering wheel heavier to turn. Decelerate as much as possible before turning off the engine.

امداد خودرو فارما

تلفن شبانه روزی: ۰۲۱-۸۸۸۶۲۰۸۵

FarmaSOS.com

امداد خودرو فارما

تلفن شبانه روزی: ۰۲۱-۸۸۸۶۲۰۸۵

FarmaSOS.com

Vehicle specifications

6

6-1. Specifications

Maintenance data (fuel, oil level, etc.)	668
Fuel information	678
Tire information	682

6-2. Customization

Customizable features	694
-----------------------------	-----

6-3. Initialization

Items to initialize	703
---------------------------	-----

تلفن شبکه روزی: ۰۲۱-۸۸۸۶۲۰۸۵

FarmaSOS.com

6-1. Specifications

Maintenance data (fuel, oil level, etc.)

Dimensions and weights

Overall length		196.5 in. (4990 mm)
Overall width		77.6 in. (1970 mm)
Overall height*1		74.0 in. (1880 mm)*2 76.2 in. (1935 mm)*3
Wheelbase		112.2 in. (2850 mm)
Tread	Front	64.6 in. (1640 mm)
	Rear	64.4 in. (1635 mm)
Vehicle capacity weight (Occupants + luggage)		1295 lb. (585 kg)
TWR (trailer weight + cargo weight)	With brake	8100 lb. (3670 kg)
	Without brake	1000 lb. (454 kg)

*1: Unladen vehicle

*2: Vehicles without roof rail and cross bar

*3: Vehicles with roof rail and cross bar

FarmaSOS.com

Vehicle identification

■ Vehicle identification number

The vehicle identification number (VIN) is the legal identifier for your vehicle. This is the primary identification number for your Toyota. It is used in registering the ownership of your vehicle.

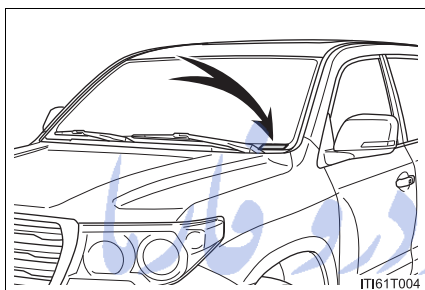

This number is stamped on the top left of the instrument panel.

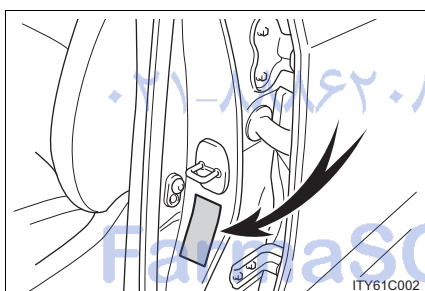

This number is also on the Certification Label.

■ Engine number

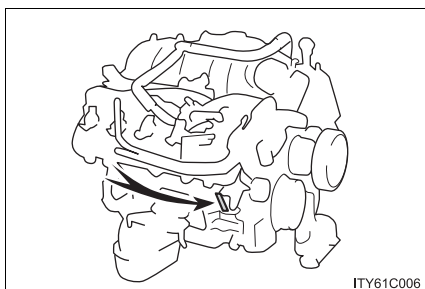

The engine number is stamped on the engine block as shown.

6-1. Specifications

Engine

Model	5.7L V8 (3UR-FE)
Type	8-cylinder V type, 4-cycle, gasoline
Bore and stroke	3.70 × 4.02 in. (94.0 × 102.0 mm)
Displacement	345.6 cu.in. (5663 cm ³)
Valve clearance	Automatic adjustment
Drive belt tension	

Fuel

Fuel type	Unleaded gasoline only
Octane rating	87 (Research octane number 91) or higher
Fuel tank capacity (Reference)	24.5 gal. (93 L, 20.4 Imp.gal)

تلفن شبانه روزی: ۰۲۱-۸۸۶۲۰۸۵

FarmaSOS.com

Lubrication system

Oil capacity (Drain and refill — reference*)	
With filter	7.9 qt. (7.5 L, 6.6 Imp.qt.)
Without filter	7.5 qt. (7.1 L, 6.2 Imp.qt.)

*: The engine oil capacity is a reference quantity to be used when changing the engine oil. Warm up and turn off the engine, wait more than 5 minutes, and check the oil level on the dipstick.

■ Engine oil selection

“Toyota Genuine Motor Oil” is used in your Toyota vehicle. Use Toyota approved “Toyota Genuine Motor Oil” or equivalent to satisfy the following grade and viscosity.

Oil grade: ILSAC GF-5 multigrade engine oil

Recommended viscosity: SAE 0W-20

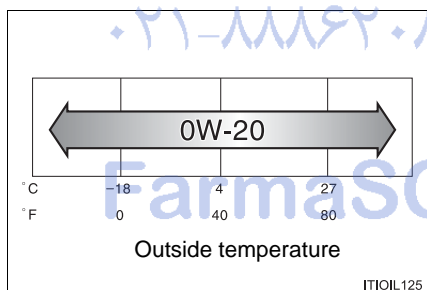

SAE 0W-20 is the best choice for good fuel economy and good starting in cold weather.

If SAE 0W-20 is not available, SAE 5W-20 oil may be used. However, it must be replaced with SAE 0W-20 at the next oil change.

6-1. Specifications

Oil viscosity (0W-20 is explained here as an example):

- The 0W in 0W-20 indicates the characteristic of the oil which allows cold startability. Oils with a lower value before the W allow for easier starting of the engine in cold weather.
- The 20 in 0W-20 indicates the viscosity characteristic of the oil when the oil is at high temperature. An oil with a higher viscosity (one with a higher value) may be better suited if the vehicle is operated at high speeds, or under extreme load conditions.

How to read oil container label:

The International Lubricant Specification Advisory Committee (ILSAC) Certification Mark is added to some oil containers to help you select the oil you should use.



Cooling system

Capacity	17.6 qt. (16.7 L, 14.7 Imp.qt.)
Coolant type	Use either of the following: <ul style="list-style-type: none"> • “Toyota Super Long Life Coolant” • Similar high-quality ethylene glycol-based non-silicate, non-amine, non-nitrite, and non-borate coolant with long-life hybrid organic acid technology Do not use plain water alone.

Ignition system

Spark plug	
Make	DENSO SK20HR11
Gap	0.043 in. (1.1 mm)

 NOTICE**■ Iridium-tipped spark plugs**

Use only iridium-tipped spark plugs. Do not adjust gap when tuning engine.

Electrical system

Battery	
Open voltage at 68°F (20°C):	12.6 — 12.8 V Fully charged 12.2 — 12.4 V Half charged 11.8 — 12.0 V Discharged (Voltage is checked 20 minutes after the key is removed with all lights turned off.)
Charging rates	5 A max.

6-1. Specifications

Differential

Oil capacity	Front	2.01 qt. (1.90 L, 1.67 Imp.qt.)
	Rear	4.44 qt. (4.20 L, 3.70 Imp.qt.)
Oil type and viscosity		Toyota Genuine Differential gear oil LT 75W-85 or equivalent

Your Toyota vehicle is filled with "Toyota Genuine Differential Oil" at the factory. Use Toyota approved "Toyota Genuine Differential Gear Oil" or an equivalent of matching quality to satisfy the above specification. Please contact your Toyota dealer for further details.

Automatic transmission

Fluid capacity	Without air-cooled type ATF cooler	12.3 qt. (11.6 L, 10.2 Imp.qt.)
	With air-cooled type ATF cooler	12.6 qt. (11.9 L, 10.5 Imp.qt.)
Fluid type		Toyota Genuine ATF WS

The fluid capacity is the quantity of reference. If replacement is necessary, contact your Toyota dealer.

NOTICE

■ Automatic transmission fluid type

Using transmission fluid other than "Toyota Genuine ATF WS" may cause deterioration in shift quality, locking up of your transmission accompanied by vibration, and ultimately damage the transmission of your vehicle.

Transfer

Oil capacity	1.53 qt. (1.45 L, 1.28 Imp.qt.)
Oil type*	Toyota Genuine Transfer Gear oil LF or equivalent
Recommended oil viscosity	SAE 75W

*: Your Toyota vehicle is filled with "Toyota Genuine Transfer Gear oil LF" at the factory. Use Toyota approved "Toyota Genuine Transfer Gear oil LF" or an equivalent of matching quality to satisfy the above specification. Please contact your Toyota dealer for further details.

Brakes

Pedal clearance* ¹	3.62 in. (92 mm) Min.
Pedal free play	0.04 — 0.24 in. (1.0 — 6.0 mm)
Brake pad wear limit	0.04 in. (1.0 mm)
Parking brake lining wear limit	0.04 in. (1.0 mm)
Parking brake adjustment* ²	5 — 7 clicks
Fluid type	SAE J1703 or FMVSS No. 116 DOT 3

*¹: Minimum pedal clearance when depressed with a force of 110 lbf (490 N, 50 kgf) while the engine is running.

*²: Parking brake pedal travel when pulled with a force of 45 lbf (200 N, 20 kgf).

Chassis lubrication

Propeller shafts	Spider	Lithium base chassis grease, NLGI No.2
	Slide yoke	Molybdenum-disulfide lithium base chassis grease, NLGI No.2 or lithium base chassis grease, NLGI No.2

6-1. Specifications

Steering

Free play	Less than 1.18 in. (30 mm)
Power steering fluid type	Automatic transmission fluid DEXRON® II or III

Tires and wheels

Tire size	P285/60R18 114V
Tire inflation pressure (Recommended cold tire inflation pressure)	Front tires: 33 psi (230 kPa, 2.3 kgf/cm ² or bar) Rear tires: 33 psi (230 kPa, 2.3 kgf/cm ² or bar) Spare tire: 33 psi (230 kPa, 2.3 kgf/cm ² or bar)
Wheel size	18 × 8 J
Wheel nut torque	97 ft•lbf (131 N•m, 13.4 kgf•m)

FarmaSOS.com

Light bulbs

	Light bulbs	Bulb No.	W	Type
Exterior	Headlights Low beam	—	35	A
	High beam	9005	60	B
	Front turn signal lights	7444NA	28	C
	Front side marker lights	—	5	C
	Fog lights	—	19	F
	Rear turn signal lights	—	16	C
	Back-up lights	921	16	C
License plate lights	—	5	C	
Interior	Front interior light	—	8	C
	Rear interior lights With rear personal lights	—	8	C
	Without rear personal lights	—	8	D
	Front personal lights	—	8	C
	Rear personal lights	—	8	C
	Vanity lights	—	2	E
	Door courtesy lights	—	5	C
Glove box light	—	1.2	C	

- A: D4S high-intensity discharge
 B: HB3 halogen bulbs
 C: Wedge base bulbs
 D: Double end bulbs
 E: Single end bulbs
 F: H16 halogen bulbs

6-1. Specifications

Fuel information

Your vehicle must use only unleaded gasoline.

Select octane rating 87 (Research Octane Number 91) or higher. Use of unleaded gasoline with an octane rating lower than 87 may result in engine knocking. Persistent knocking can lead to engine damage.

At minimum, the gasoline you use should meet the specifications of ASTM D4814 in the U.S.A.

■ Fuel tank opening for unleaded gasoline

To help prevent incorrect fueling, your Toyota has a fuel tank opening that only accommodates the special nozzle on unleaded fuel pumps.

■ If your engine knocks

- Consult your Toyota dealer.
- You may occasionally notice light knocking for a short time while accelerating or driving uphill. This is normal and there is no need for concern.

■ Gasoline quality

In very few cases, driveability problems may be caused by the brand of gasoline you are using. If driveability problems persist, try changing the brand of gasoline. If this does not correct the problem, consult your Toyota dealer.

FarmaSOS.com

■ Gasoline quality standards

- Automotive manufacturers in the US, Europe and Japan have developed a specification for fuel quality called World-Wide Fuel Charter (WWFC) that is expected to be applied worldwide.
- The WWFC consists of four categories that are based on required emission levels. In the US, category 4 has been adopted.
- The WWFC improves air quality by lowering emissions in vehicle fleets, and customer satisfaction through better performance.

■ Toyota recommends the use of gasoline containing detergent additives

- Toyota recommends the use of gasoline that contains detergent additives to avoid build-up of engine deposits.
- All gasoline sold in the US contains minimum detergent additives to clean and/or keep clean intake systems, per EPA's lowest additives concentration program.
- Toyota strongly recommends the use of Top Tier Detergent Gasoline. For more information on Top Tier Detergent Gasoline and a list of marketers, please go to the official website www.toptiergas.com.

■ Toyota recommends the use of cleaner burning gasoline

Cleaner burning gasoline, including reformulated gasoline that contains oxygenates such as ethanol or MTBE (Methyl Tertiary Butyl Ether) is available in many areas.

Toyota recommends the use of cleaner burning gasoline and appropriately blended reformulated gasoline. These types of gasoline provide excellent vehicle performance, reduce vehicle emissions and improve air quality.

■ **Toyota does not recommend blended gasoline**

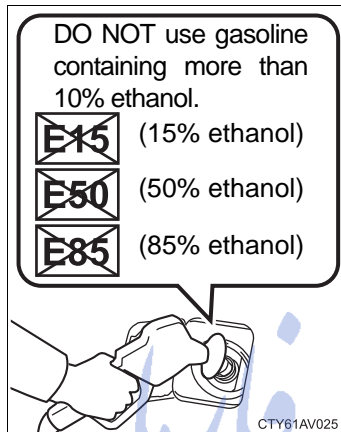

- Use only gasoline containing a maximum of 10% ethanol. DO NOT use any flex-fuel or gasoline that could contain more than 10% ethanol, including from any pump labeled E15, E30, E50, E85 (which are only some examples of fuel containing more than 10% ethanol).

- If you use gasoline in your Toyota, be sure that it has an octane rating no lower than 87.
- Toyota DOES NOT recommend the use of gasoline containing methanol.

■ **Toyota does not recommend gasoline containing MMT**

Some gasoline contains octane enhancing additive called MMT (Methylcyclopentadienyl Manganese Tricarbonyl).

Toyota DOES NOT recommend the use of gasoline that contains MMT. If fuel containing MMT is used, your emission control system may be adversely affected.

The malfunction indicator lamp on the instrument cluster may come on. If this happens, contact your Toyota dealer for service.

 NOTICE

■ **Notice on fuel quality**

- Do not use improper fuels. If improper fuels are used the engine will be damaged.
- Do not use leaded gasoline.
Leaded gasoline can cause damage to your vehicle's three-way catalytic converters causing the emission control system to malfunction.
- Do not use gasohol other than that stated here.
Other gasohol may cause fuel system damage or vehicle performance problems.
- Using unleaded gasoline with an octane number or rating lower than that stated here will cause persistent heavy knocking.
At worst, this will lead to engine damage.

■ **Fuel-related poor driveability**

If after using a different type of fuel, poor driveability is encountered (poor hot starting, vaporization, engine knocking, etc.), discontinue the use of that type of fuel.

■ **When refueling with gasohole**

Take care not to spill gasohol. It can damage your vehicle's paint.

FarmaSOS.com

6-1. Specifications Tire information

Typical tire symbols

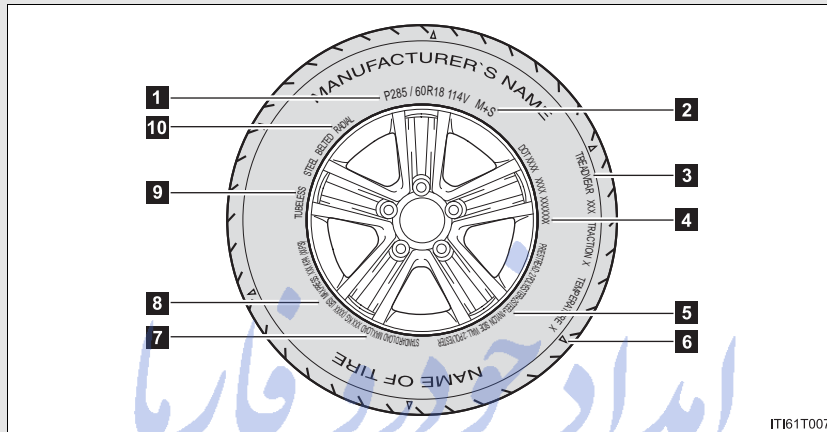

- 1** Tire size (→P. 684)
- 2** Summer tire or all season tire (→P. 548)
An all season tire has “M+S” on the sidewall. A tire not marked “M+S” is a summer tire.
- 3** Uniform tire quality grading
For details, see “Uniform Tire Quality Grading” that follows.
- 4** DOT and Tire Identification Number (TIN) (→P. 683)
- 5** Tire ply composition and materials
Plies are layers of rubber-coated parallel cords. Cords are the strands which form the plies in a tire.
- 6** Location of treadwear indicators (→P. 685)
- 7** Load limit at maximum cold tire inflation pressure (→P. 687)

8 Maximum cold tire inflation pressure (→P. 687)

This means the pressure to which a tire may be inflated.

9 TUBELESS or TUBE TYPE

A tubeless tire does not have a tube and air is directly filled in the tire. A tube type tire has a tube inside the tire and the tube maintains the air pressure.

10 Radial tires or bias-ply tires

A radial tire has RADIAL on the sidewall. A tire not marked RADIAL is a bias-ply tire.

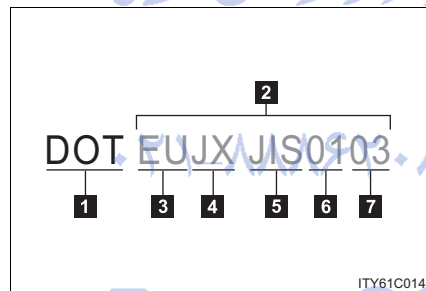
Typical DOT and tire identification number (TIN)**1** DOT symbol***2** Tire Identification Number (TIN)**3** Tire manufacturer's identification mark**4** Tire size code**5** Manufacturer's optional tire type code (3 or 4 letters)**6** Manufacturing week**7** Manufacturing year

*:The DOT symbol certifies that the tire conforms to applicable Federal Motor Vehicle Safety Standards.

Tire size

■ Typical tire size information

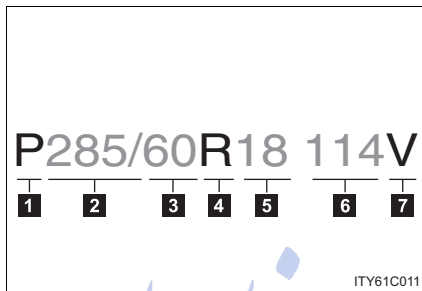

The illustration indicates typical tire size.

- 1** Tire use
(P = Passenger car,
T = Temporary use)
- 2** Section width (millimeters)
- 3** Aspect ratio
(tire height to section width)
- 4** Tire construction code
(R = Radial, D = Diagonal)
- 5** Wheel diameter (inches)
- 6** Load index (2 or 3 digits)
- 7** Speed symbol
(alphabet with one letter)

■ Tire dimensions

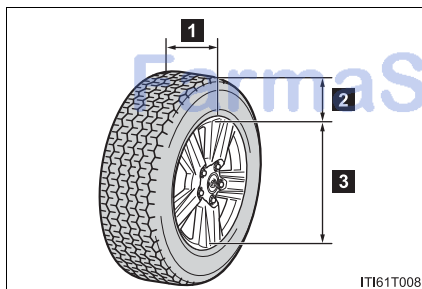

- 1** Section width
- 2** Tire height
- 3** Wheel diameter

Tire section names

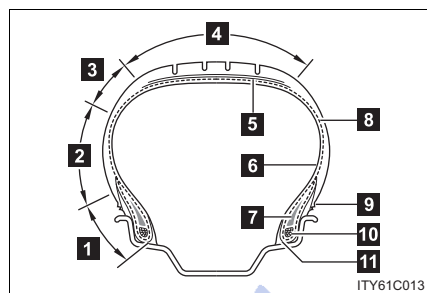

- 1 Bead
- 2 Sidewall
- 3 Shoulder
- 4 Tread
- 5 Belt
- 6 Inner liner
- 7 Reinforcing rubber
- 8 Carcass
- 9 Rim lines
- 10 Bead wires
- 11 Chafer

Uniform Tire Quality Grading

This information has been prepared in accordance with regulations issued by the National Highway Traffic Safety Administration of the U.S.A. Department of Transportation.

It provides the purchasers and/or prospective purchasers of Toyota vehicles with information on uniform tire quality grading.

Your Toyota dealer will help answer any questions you may have as you read this information.

■ DOT quality grades

All passenger vehicle tires must conform to Federal Safety Requirements in addition to these grades. Quality grades can be found where applicable on the tire sidewall between tread shoulder and maximum section width.

For example: Treadwear 200 Traction AA Temperature A

■ **Treadwear**

The treadwear grade is a comparative rating based on the wear rate of the tire when tested under controlled conditions on a specified government test course.

For example, a tire graded 150 would wear one and a half (1 - 1/2) times as well on the government course as a tire graded 100.

The relative performance of tires depends upon the actual conditions of their use, however, and may depart significantly from the norm due to variations in driving habits, service practices and differences in road characteristics and climate.

■ **Traction AA, A, B, C**

The traction grades, from highest to lowest, are AA, A, B and C, and they represent the tire's ability to stop on wet pavement as measured under controlled conditions on specified government test surfaces of asphalt and concrete.

A tire marked C may have poor traction performance.

Warning: The traction grade assigned to this tire is based on braking (straight ahead) traction tests and does not include cornering (turning) traction.

■ **Temperature A, B, C**

The temperature grades are A (the highest), B, and C, representing the tire's resistance to the generation of heat and its ability to dissipate heat when tested under controlled conditions on a specified indoor laboratory test wheel.

Sustained high temperature can cause the material of the tire to degenerate and reduce tire life, and excessive temperature can lead to sudden tire failure.

The grade C corresponds to a level of performance which all passenger car tires must meet under the Federal Motor Vehicle Safety Standard No. 109.

Grades B and A represent higher levels of performance on the laboratory test wheel than the minimum required by law.

Warning: The temperature grades for this tire are established for a tire that is properly inflated and not overloaded.

Excessive speed, underinflation, or excessive loading, either separately or in combination, can cause heat buildup and possible tire failure.

Glossary of tire terminology

Tire related term	Meaning
Cold tire inflation pressure	Tire pressure when the vehicle has been parked for three hours or more, or has not been driven more than 1 mile or 1.5 km under that condition
Maximum inflation pressure	The maximum cold inflated pressure to which a tire may be inflated, shown on the sidewall of the tire
Recommended inflation pressure	Cold tire inflation pressure recommended by a manufacturer.
Accessory weight	The combined weight (in excess of those standard items which may be replaced) of transmission, power steering, power brakes, power windows, power seats, radio and heater, to the extent that these items are available as factory-installed equipment (whether installed or not)
Curb weight	The weight of a motor vehicle with standard equipment, including the maximum capacity of fuel, oil and coolant, and if so equipped, air conditioning and additional weight optional engine
Maximum loaded vehicle weight	The sum of: (a) Curb weight (b) Accessory weight (c) Vehicle capacity weight (d) Production options weight

6-1. Specifications

Tire related term	Meaning
Normal occupant weight	150 lb. (68 kg) times the number of occupants specified in the second column of Table 1* that follows
Occupant distribution	Distribution of occupants in a vehicle as specified in the third column of Table 1* below
Production options weight	The combined weight of installed regular production options weighing over 5 lb. (2.3 kg) in excess of the standard items which they replace, not previously considered in curb weight or accessory weight, including heavy duty brakes, ride levelers, roof rack, heavy duty battery, and special trim
Rim	A metal support for a tire or a tire and tube assembly upon which the tire beads are seated
Rim diameter (Wheel diameter)	Nominal diameter of the bead seat
Rim size designation	Rim diameter and width
Rim type designation	The industry manufacturer's designation for a rim by style or code
Rim width	Nominal distance between rim flanges
Vehicle capacity weight (Total load capacity)	The rated cargo and luggage load plus 150 lb. (68 kg) times the vehicle's designated seating capacity
Vehicle maximum load on the tire	The load on an individual tire that is determined by distributing to each axle its share of the maximum loaded vehicle weight, and dividing by two

Tire related term	Meaning
Vehicle normal load on the tire	The load on an individual tire that is determined by distributing to each axle its share of curb weight, accessory weight, and normal occupant weight (distributed in accordance with Table 1* below), and dividing by two
Weather side	The surface area of the rim not covered by the inflated tire
Bead	The part of the tire that is made of steel wires, wrapped or reinforced by ply cords and that is shaped to fit the rim
Bead separation	A breakdown of the bond between components in the bead
Bias ply tire	A pneumatic tire in which the ply cords that extend to the beads are laid at alternate angles substantially less than 90 degrees to the centerline of the tread
Carcass	The tire structure, except tread and sidewall rubber which, when inflated, bears the load
Chunking	The breaking away of pieces of the tread or sidewall
Cord	The strands forming the plies in the tire
Cord separation	The parting of cords from adjacent rubber compounds
Cracking	Any parting within the tread, sidewall, or inner-liner of the tire extending to cord material
CT	A pneumatic tire with an inverted flange tire and rim system in which the rim is designed with rim flanges pointed radially inward and the tire is designed to fit on the underside of the rim in a manner that encloses the rim flanges inside the air cavity of the tire

6-1. Specifications

Tire related term	Meaning
Extra load tire	A tire designed to operate at higher loads and at higher inflation pressures than the corresponding standard tire
Groove	The space between two adjacent tread ribs
Innerliner	The layer(s) forming the inside surface of a tubeless tire that contains the inflating medium within the tire
Innerliner separation	The parting of the innerliner from cord material in the carcass
Intended outboard sidewall	(a)The sidewall that contains a whitewall, bears white lettering, or bears manufacturer, brand, and/or model name molding that is higher or deeper than the same molding on the other sidewall of the tire, or (b)The outward facing sidewall of asymmetrical tire that has a particular side that must always face outward when mounted on a vehicle
Light truck (LT) tire	A tire designated by its manufacturer as primarily intended for use on lightweight trucks or multipurpose passenger vehicles
Load rating	The maximum load that a tire is rated to carry for a given inflation pressure
Maximum load rating	The load rating for a tire at the maximum permissible inflation pressure for that tire
Maximum permissible inflation pressure	The maximum cold inflation pressure to which a tire may be inflated
Measuring rim	The rim on which a tire is fitted for physical dimension requirements
Open splice	Any parting at any junction of tread, sidewall, or innerliner that extends to cord material
Outer diameter	The overall diameter of an inflated new tire

Tire related term	Meaning
Overall width	The linear distance between the exteriors of the sidewalls of an inflated tire, including elevations due to labeling, decorations, or protective bands or ribs
Passenger car tire	A tire intended for use on passenger cars, multipurpose passenger vehicles, and trucks, that have a gross vehicle weight rating (GVWR) of 10,000 lb. or less
Ply	A layer of rubber-coated parallel cords
Ply separation	A parting of rubber compound between adjacent plies
Pneumatic tire	A mechanical device made of rubber, chemicals, fabric and steel or other materials, that, when mounted on an automotive wheel, provides the traction and contains the gas or fluid that sustains the load
Radial ply tire	A pneumatic tire in which the ply cords that extend to the beads are laid at substantially 90 degrees to the centerline of the tread
Reinforced tire	A tire designed to operate at higher loads and at higher inflation pressures than the corresponding standard tire
Section width	The linear distance between the exteriors of the sidewalls of an inflated tire, excluding elevations due to labeling, decoration, or protective bands
Sidewall	That portion of a tire between the tread and bead
Sidewall separation	The parting of the rubber compound from the cord material in the sidewall

6-1. Specifications

Tire related term	Meaning
Snow tire	A tire that attains a traction index equal to or greater than 110, compared to the ASTM E-1136 Standard Reference Test Tire, when using the snow traction test as described in ASTM F-1805-00, Standard Test Method for Single Wheel Driving Traction in a Straight Line on Snow-and Ice-Covered Surfaces, and which is marked with an Alpine Symbol () on at least one sidewall
Test rim	The rim on which a tire is fitted for testing, and may be any rim listed as appropriate for use with that tire
Tread	That portion of a tire that comes into contact with the road
Tread rib	A tread section running circumferentially around a tire
Tread separation	Pulling away of the tread from the tire carcass
Treadwear indicators (TWI)	The projections within the principal grooves designed to give a visual indication of the degrees of wear of the tread
Wheel-holding fixture	The fixture used to hold the wheel and tire assembly securely during testing

*: Table 1 — Occupant loading and distribution for vehicle normal load for various designated seating capacities

Designated seating capacity, Number of occupants	Vehicle normal load, Number of occupants	Occupant distribution in a normally loaded vehicle
2 through 4	2	2 in front
5 through 10	3	2 in front, 1 in second seat
11 through 15	5	2 in front, 1 in second seat, 1 in third seat, 1 in fourth seat
16 through 20	7	2 in front, 2 in second seat, 2 in third seat, 1 in fourth seat

تلفن شبانه روزی: ۰۲۱-۸۸۸۶۲۰۸۵

FarmaSOS.com

6-2. Customization Customizable features

Your vehicle includes a variety of electronic features that can be personalized to your preferences.

Programming of these preferences can be performed by your Toyota dealer.

For vehicles with the navigation system, it is also possible to customize certain vehicle features yourself using the touch screen.

Some function settings are changed simultaneously with other functions being customized. Contact your Toyota dealer for further details.

Customizing vehicle features using the touch screen (vehicles with navigation system)

STEP 1 Press "SETUP".

STEP 2 Touch "Vehicle" on the "Setup" screen.

STEP 3 Touch "Vehicle Customization".

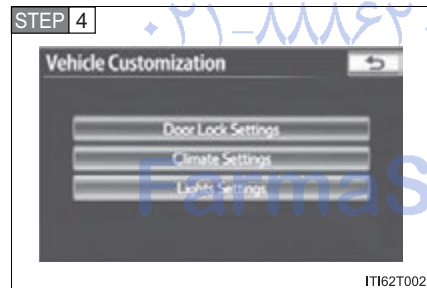

Touch the setting to be changed. Change each setting and touch "Save".

If "Save" is not touched before switching to another screen, any changes will be lost.

STEP 5 A message indicating that the settings are being saved will appear.

Do not perform any other operations while this message is displayed.

Customizable features

Vehicle customization settings can be changed at your Toyota dealer. For vehicles with the navigation system, some settings can be changed using the touch screen.

- 1** Settings that can be changed using the touch screen
- 2** Settings that can be changed using the vehicle switches
- 3** Settings that can be changed by your Toyota dealer

Definition of symbols: O= Available, — = Not available

Item	Function	Default setting	Customized setting	1	2	3
Smart key system (→P. 32)	Smart key system	On	Off	O	—	O
	Smart door unlocking	Driver's door	All the doors	O	O	O

تلفن شبانه روزی: ۰۲۱-۸۸۸۶۲۰۸۵

FarmaSOS.com

6-2. Customization

Item	Function	Default setting	Customized setting	1	2	3
Wireless remote control (→P. 44)	Wireless remote control	On	Off	—	—	○
	Open door warning function (when locking the vehicle)	On	Off	—	—	○
	Unlocking operation	Driver's door unlocked in one step, all doors unlocked in two steps	All doors unlocked in one step	○	—	○
Smart key system (→P. 32) and wireless remote control (→P. 44)	Operation signal (Emergency flashers)	On	Off	○	—	○
	Time elapsed before automatic door lock function is activated if door is not opened after being unlocked	60 seconds	Off	○	—	○
			30 seconds			
	Adjust the volume of confirmation buzzer sounds when the vehicle is locked or unlocked	7	Off	○	—	○
1 to 6						

Item	Function	Default setting	Customized setting	1	2	3
Door lock (→P. 46)	Unlocking using a mechanical key	Driver's door unlocked in one step, all doors unlocked in two steps	All doors unlocked in one step	0	—	0
	Speed-detecting automatic door lock function	Off	On	0	0	0
	Shifting the shift lever to position other than "P" locks all doors	On	Off	0	0	0
	Shifting the shift lever to "P" unlocks all doors	On	Off	0	0	0
	Opening driver's door unlocks all doors	Off	On	0	0	0
Power windows (→P. 93)	Mechanical key linked operation (close)	Off	On	—	—	0
	Mechanical key linked operation (open)	Off	On	—	—	0
	Wireless remote control linked operation (open)	Off	On	—	—	0
	Linked entry function	Off	On	—	—	0

6-2. Customization

Item	Function	Default setting	Customized setting	1	2	3
Moon roof (→P. 97)	Mechanical key linked operation (open) *1	Off	On	—	—	○
	Mechanical key linked operation (close) *1	Off	On	—	—	○
	Linked operation of components when door key is used	Slide only	Tilt only	—	—	○
	Wireless remote control linked operation (open) *2	Off	On	—	—	○
	Linked operation of components when wireless remote control used	Slide only	Tilt only	—	—	○
	Linked entry function *3	Off	On	—	—	○

Item	Function	Default setting	Customized setting	1	2	3
Illumination (→P. 462)	Time period before the interior lights turn off	15 seconds	Off	0	—	0
			7.5 seconds			
			30 seconds			
	Operation after the "ENGINE START STOP" switch is turned off	On	Off	—	—	0
	Operation when the doors are unlocked	On	Off	—	—	0
	Operation when you approach the vehicle with the electronic key on your person (When the interior light switch is door position)	On	Off	—	—	0
Sensitivity of the ambient light sensor used for dimming the meter lights etc.	Standard	-2 to 2	—	—	0	
Sensitivity of the ambient light sensor used for brightening the meter lights etc.	Standard	-2 to 2	—	—	0	

6-2. Customization

Item	Function	Default setting	Customized setting	1	2	3
Automatic light control system (→P. 196)	Light sensor sensitivity	Standard	-2 to 2	○	—	○
	Daytime running light system	On	Off	○	—	○
	Time elapsed before headlights automatically turn off after doors are closed	30 seconds	Off	○	—	○
			60 seconds			
			90 seconds			
Intuitive parking assist (→P. 229)	Detection distance of the rear center sensor	Far	Near	○	—	○
	Alert Volume (alert volume can be adjusted)	3	1 to 5	○	—	○
	Display setting (when intuitive parking assist is operating)	All sensors displayed	Display off	○	—	○
Automatic air conditioning system (→P. 336)	A/C Auto switch operation	Auto	Manual	○	—	○
Eco Driving Indicator Light (→P. 156)	Eco Driving Indicator Light	On	Off	—	○	○

- *1: The settings can be changed when the mechanical key linked operation of the power window is set to ON.
- *2: The settings can be changed when the wireless remote control linked operation of the power window is set to ON.
- *3: The settings can be changed when the entry function linked operation of the power window is set to ON.

■ Vehicle customization

- If the smart key system is turned "OFF", unlock door cannot be selected.
- If the doors are not opened after unlocking and are then automatically re-locked, a signal will be given if "Operation signal (Emergency flashers)" or "Operation signal (Buzzer)" are set to ON.

■ When setting using the vehicle switches (vehicles with navigation system)

When using the vehicle switches to set an item that can also be set using the touch screen, the item displayed on the touch screen will not change immediately.

If the "ENGINE START STOP" switch is first turned to OFF, the screen display will change once the "ENGINE START STOP" switch is turned to IGNITION ON mode again.

■ When customizing using the touch screen (vehicles with navigation system)

Stop the vehicle in a safe place, apply the parking brake, and shift the shift lever to "P". Also, to prevent battery discharge, leave the engine running while customizing the features.

6-2. Customization

CAUTION

■ During customization

As the engine needs to be running during customization, ensure that the vehicle is parked in a place with adequate ventilation. In a closed area such as a garage, exhaust gases including harmful carbon monoxide (CO) may collect and enter the vehicle. This may lead to death or a serious health hazard.

NOTICE

■ During customization

To prevent battery discharge, ensure that the engine is running while customizing features.

Multi-information display (→P. 189)

Available languages – English (U.S.A.), Spanish

FarmaSOS.com

6-3. Initialization Items to initialize

The following items must be initialized for normal system operation in cases such as after the battery is reconnected, or maintenance is performed on the vehicle.

Item	When to initialize	Reference
Maintenance data	After the maintenance is performed	P. 519
Tire pressure warning system	<ul style="list-style-type: none">• When rotating the tires on vehicles differing with front and rear tire inflation pressures.• When changing the tire inflation pressure by changing traveling speed or load weight, etc.• When changing the tire size.	P. 545
Multi-terrain Monitor*	After reconnecting or changing the battery	P. 278

*: If equipped
تلفن شبانه روزی: ۰۸۵-۸۸۶۲۰۲۱

FarmaSOS.com

امداد خودرو فارما

تلفن شبانه روزی: ۰۲۱-۸۸۸۶۲۰۸۵

FarmaSOS.com

For U.S. owners

7

Reporting safety defects
for U.S. owners 706

امداد خودرو فارما

تلفن شبكه روزي: ۰۲۱-۸۸۸۶۲۰۸۵

FarmaSOS.com

705

Reporting safety defects for U.S. owners

If you believe that your vehicle has a defect which could cause a crash or could cause injury or death, you should immediately inform the National Highway Traffic Safety Administration (NHTSA) in addition to notifying Toyota Motor Sales, U.S.A., Inc. (Toll-free: 1-800-331-4331).

If NHTSA receives similar complaints, it may open an investigation, and if it finds that a safety defect exists in a group of vehicles, it may order a recall and remedy campaign. However, NHTSA cannot become involved in individual problems between you, your dealer, or Toyota Motor Sales, U.S.A., Inc.

To contact NHTSA, you may call the Vehicle Safety Hotline toll-free at 1-888-327-4236 (TTY: 1-800-424-9153); go to <http://www.safercar.gov>; or write to: Administrator, NHTSA, 1200 New Jersey Ave, S.E., Washington, DC 20590. You can also obtain other information about motor vehicle safety from <http://www.safercar.gov>.

تلفن شبانه روزی: ۰۲۱-۸۸۸۶۲۰۸۵

FarmaSOS.com

Index

Abbreviation list 708

Alphabetical index 710

What to do if... 720

For vehicles with a navigation system, refer to the “Navigation System Owner’s Manual” for information regarding the equipment listed below.

- Navigation system
- Air conditioning
- Climate control
- Audio/video system
- Rear view monitor system
- Hands-free system

FarmaSOS.com

Abbreviation list

Abbreviation/Acronym list

ABBREVIATIONS	MEANING
4WD	Four Wheel Drive
A/C	Air conditioning
ABS	Anti-lock Brake System
AI-SHIFT	Artificial Intelligence Shift control
ALR	Automatic Locking Retractor
AUX	Auxiliary
CRS	Child Restraint System
DISP	Display
ECT	Electronic Controlled Transmission
EDR	Event Data Recorder
ELR	Emergency Locking Retractor
GAWR	Gross Axle Weight Rating
GCWR	Gross Combination Weight Rating
GPS	Global Positioning System
GVWR	Gross Vehicle Weight Rating
I/M	Emission inspection and maintenance
INT	Intermittent
KDSS	Kinetic Dynamic Suspension System
LATCH	Lower Anchors and Tethers for Children
LED	Light Emitting Diode
MMT	Methylcy clopentaadienyl Manganese Tricarbonyl

ABBREVIATIONS	MEANING
M+S	Mud and Snow
MTBE	Methyl Tertiary Butyl Ether
PCS	Pre-Collision System
PWR	Power
RDS	Radio Data System
RSCA	Roll Sensing of Curtain Shield airbag
SRS	Supplemental Restraint System
TIN	Tire Identification Number
TPMS	Tire Pressure Warning System
TRAC	Traction Control
TWR	Trailer Weight Rating
VIN	Vehicle Identification Number
VSC	Vehicle Stability Control

تلفن شبانه روزی: ۰۲۱-۸۸۶۲۰۸۵

FarmaSOS.com

Alphabetical index

Alphabetical index

A

A/C

Air conditioning filter.....	560
Automatic air conditioning system (vehicles without navigation system).....	336
Automatic air conditioning system (vehicles with navigation system)*	
ABS	281
Active traction control.....	281
Air conditioning filter.....	560
Air conditioning system (vehicles without navigation system)	
Air conditioning filter.....	560
Automatic air conditioning system	336
Air conditioning system (vehicles with navigation system)*	
Airbags	
Airbag operating conditions...	117
Airbag precautions for your child	122
Airbag warning light.....	609
Curtain shield airbag operating conditions.....	117
Curtain shield airbag precautions	122
Front passenger occupant classification system	130
General airbag precautions...	122
Locations of airbags.....	113
Modification and disposal of airbags	125
Proper driving posture... 111, 122	
Roll sensing of curtain shield airbags off switch	128
Side airbag operating conditions.....	117
Side airbag precautions	122
SRS airbags	113

Alarm.....	107
Antenna	361
Anti-lock brake system	281
Armrest	491
Ashtrays	482
Assist grips	492
Audio input.....	397
Audio system (vehicles without navigation system)	
Antenna.....	361
Audio input	397
AUX port	397
CD player/changer	365
iPod.....	380
MP3/WMA disc	373
Optimal use.....	395
Portable audio device	397
Radio.....	356
Steering wheel audio switch.....	398
USB memory.....	387
Audio/video system (vehicles with navigation system)*	
Automatic air conditioning system (vehicles without navigation system).....	336
Automatic air conditioning system (vehicles with navigation system)*	
Automatic light control system	196
Automatic transmission	
Automatic transmission.....	171
If the shift lever cannot be shifted from "P"	651
"S" mode	173
AUX port	397
Auxiliary box	466, 474

<p>B</p> <p>Back door Back door 51 Wireless remote control key ... 44</p> <p>Back-up lights Replacing light bulbs 582 Wattage 677</p> <p>Battery If the vehicle has discharged battery 656 Preparing and checking before winter 309</p> <p>Bluetooth® audio (vehicles without navigation system) 402</p> <p>Bluetooth® audio (vehicles with navigation system)*</p> <p>Bluetooth® phone (vehicles without navigation system) 423</p> <p>Bluetooth® phone (vehicles with navigation system)*</p> <p>Bottle holder 472</p> <p>Brake Fluid..... 537 Parking brake 177</p> <p>Brake assist 281</p> <p>Break-in tips 155</p> <p>Brightness control Instrument light control 182</p>	<p>C</p> <p>Care Exterior.....512 Interior.....515 Seat belts516</p> <p>Card holder474</p> <p>Cargo capacity301</p> <p>Cargo net hooks.....495</p> <p>CD player*/changer*365</p> <p>Center differential lock/unlock switch.....240</p> <p>Chains311</p> <p>Child-protectors47</p> <p>Child restraint system Booster seats, definition 135 Booster seats, installation 140 Convertible seats, definition 135 Convertible seats, installation..... 140 Front passenger occupant classification system 129 Infant seats, definition 135 Infant seats, installation..... 140 Installing CRS with LATCH system..... 141 Installing CRS with seat belts 143 Installing CRS with top tether strap..... 148</p>
---------------------------------------------------------------------------------------------------------------------------------------------------------------------------------------------------------------------------------------------------------------------------------------------------------------------------------------------------------------------------------------------------------------------------------------------------------------------------------------------------------------------------------------------------------------------------------------------------------------------------------------------------------------------------------------------------------------------------------------------------------------------------------------------------------------------------------------------------------------------------------------------------------------------------------------------------------------------------------------------------------------------------------------------------------------------------------------------	---------------------------------------------------------------------------------------------------------------------------------------------------------------------------------------------------------------------------------------------------------------------------------------------------------------------------------------------------------------------------------------------------------------------------------------------------------------------------------------------------------------------------------------------------------------------------------------------------------------------------------------------------------------------------------------------------------------------------------------------------------------------------------------------------------------------------------------------------------------------------------------------------------------------------------------------------------------------------------------------------------------------------------------------------------------------------------------------------------------------------

*: For vehicles with a navigation system, refer to the "Navigation System Owner's Manual".

Child safety	
Airbag precautions	122
Battery precautions	542, 565
Child-protectors	47
Child restraint system	135
How your child should wear the seat belt	81
Installing child restraints	140
Moon roof precautions	100
Power window lock switch	93
Power window precautions	96
Removed key battery precautions	563
Seat belt extender precautions	84
Seat belt precautions	82
Seat heater precautions	490
Cigarette lighter	484
Cleaning	
Exterior	512
Interior	515
Seat belts	516
Clock (vehicles without navigation system)	479
Clock (vehicles with navigation system)*	536
Condenser	468
Console box	475
Cool box	475
Cooling system	
Engine overheating	659
Crawl Control	245
Cruise control	210
Cup holder	470
Curtain shield airbags	113
Customizable features	694
D	
Daytime running light system	199
Defogger	
Rear window	351
Side mirror	351
Dimension	668
Dinghy towing	332
Display	
Crawl Control display	245
Dynamic radar cruise control	214
Intuitive parking assist display	229
Multi-information display	189
Shift position and shift range	173
Trip information	190
Warning messages	619
Do-it-yourself maintenance ...	525
Door courtesy lights	
Door courtesy lights	462
Wattage	677
Door lock تلفن شبانه ۰۸۵۰۰۰۰۰۰۰۰۰	
Back door	51
Side door	46
Wireless remote control key ...	44
Doors	
Back door	51
Side door	46
Side mirrors	90
Driver's seat belt reminder light	611
Driving	
Break-in tips	155
Correct posture	111
Off-road precautions	296
Procedures	154
Winter driving tips	309
Driving position memory	68
Dynamic radar cruise control	214

E	Eco driving	156
	Electronic key	
	If your electronic key battery is discharged ..	563, 653
	Emergency flashers	
	Switch.....	600
	Emergency, in case of	
	If a warning message is displayed.....	619
	If the electronic key does not operate properly.....	653
	If the engine will not start.....	649
	If the shift lever cannot be shifted from "P"	651
	If the vehicle has discharged battery	656
	If the warning buzzer sounds	608
	If the warning light turns on ..	608
	If you have a flat tire	635
	If you lose your keys.....	652
	If you think something is wrong	606
	If your vehicle becomes stuck.....	662
	If your vehicle has to be stopped in an emergency...	664
	If your vehicle needs to be towed	601
	If your vehicle overheats	659
	Engine	
	Compartment.....	529
	Engine switch	166
	Hood.....	528
	How to start the engine	166
	Identification number	669
	If the engine will not start.....	649
	Ignition switch.....	166
	Overheating.....	659

Engine coolant	
Capacity	673
Checking	535
Preparing and checking before winter	309
Engine coolant temperature gauge	179
Engine immobilizer system.....	105
Engine oil	
Capacity	671
Checking	531
Preparing and checking before winter	309
Engine switch.....	166
Event data recorder	25
F	
First-aid kit holder.....	495
Floor mats.....	493
Fluid	
Brake.....	537
Power steering	539
Washer.....	543
Fog lights	
Replacing light bulbs	582
Switch.....	201
Wattage.....	677
Four-wheel drive system.....	240
Front fog lights	
Replacing light bulbs	582
Switch.....	201
Wattage.....	677
Front passenger's seat belt reminder light.....	611
Front seats	
Adjustment	57
Driving position memory.....	68
Front side marker light	
Replacing light bulbs	582
Wattage.....	677

*: For vehicles with a navigation system, refer to the "Navigation System Owner's Manual".

Alphabetical index

Front turn signal lights	
Replacing light bulbs	582
Wattage	677
Fuel	
Capacity	670
Fuel gauge	179
Fuel pump shut off system	607
Gas station information	724
Information	678
Refueling	101
Type	678
Fuel door	101
Fuel filler door	101
Fuel pump shut off system	607
Fuses	566
G	
Garage door opener	497
Gas station information	724
Gauges	179
Glove box	467
Glove box light	467
H	
Hands-free system (for cellular phone)*	423
Hazard lights	
Switch	600
Head restraints	
Adjusting	72
Headlight cleaner	209
Headlights	
Replacing light bulbs	582
Switch	196
Wattage	677
Heaters	
Heated steering	487
Seat heaters	489
Side mirror	351
Hill-start assist control	281
Hood	528

Hooks	
Cargo hook	495
Tie-down hooks	495
Horn	178
I	
I/M test	524
Identification	
Engine	669
Vehicle	669
Ignition	
Engine switch	166
Keys	30
Ignition switch	166
Ignition switch	166
Illuminated entry system	465
Indicator lights	184
Initialization	
Items to initialize	703
Inside rear view mirror	88
Instrument panel light control	182
Interior lights	
Interior lights	462
Switch	463
Wattage	677
Intuitive parking assist	229
J	
Jack	
Vehicle-equipped jack	635
Jack handle	635
K	
KDSS	281
Keyless entry	32

Keys

Electronic key 30
 If you lose your keys..... 652
 If your electronic key
 battery is discharged.. 563, 653
 Ignition switch..... 166
 Keyless entry..... 32
 Key number 30
 Keys 30
 Mechanical key..... 30
 Wireless remote control key... 44

L Language

Multi-information
 display..... 189, 702

Licence plate lights

Replacing light bulbs 582
 Wattage 677

Light bulbs

Replacing 582
 Wattage 677

Lights

Door courtesy lights..... 423
 Emergency flasher switch 600
 Fog light switch..... 201
 Hazard light switch 600
 Headlights 196
 Interior light switch..... 463
 Personal light switch..... 464
 Replacing light bulbs 582
 Turn signal lever..... 176
 Vanity lights 478
 Wattage 677

Load capacity 308

M Maintenance

Do-it-yourself maintenance ...525
 General maintenance.....521
 Maintenance data.....668
 Maintenance requirements...518
 Reset the maintenance
 data.....519

Meter

Instrument panel light
 control 182
 Meters 179

Micro dust and pollen filter342

Mirrors

Inside rear view mirror.....88
 Side mirror heater351
 Side mirrors.....90
 Vanity mirrors478

Moon roof97

MP3 disc373

Multi-information display189

Multi Terrain ABS.....281

Multi-terrain Monitor257

Multi-terrain Select.....251

N Navigation System*

Noise from under vehicle22

O Odometer179

Off-road precautions296

Oil

Engine oil531

Opener

Fuel filler door 101
 Hood.....528

Outside rear view mirrors

Adjusting and folding.....90
 Mirror position memory68

Outside temperature

display480

Overhead console.....469

Overheating, Engine659

*: For vehicles with a navigation system, refer to the "Navigation System Owner's Manual".

Alphabetical index

P	Parking brake 177	S	Safety Connect 504
	Parking lights		Seat belts
	Switch..... 196		Adjusting the seat belt..... 79
	PCS 289		Automatic Locking
	Personal lights		Retractor..... 80
	Personal lights..... 464		Child restraint system
	Switch..... 464		installation..... 140
	Wattage..... 677		Cleaning and maintaining
	Power outlet 485		the seat belts 516
	Power steering		Emergency Locking
	Fluid 539		Retractor..... 80
	Power windows 93		How to wear your seat belt 76
	Pre-Collision System 289		How your child should wear
			the seat belt 81
R	Radiator 536		Pregnant women,
	Radio 356		proper seat belt use 82
	RDS 360		Reminder light..... 611
	Rear seats		Seat belt extenders 81
	Adjustment 59		Seat belt pretensioners 79
	Tumbling second seats 60		Seat heaters 489
	Tumbling third seats 63		Seats
	Rear turn signal lights		Adjustment precautions 58
	Replacing light bulbs 582		Child seats/child restraint
	Wattage..... 677		system installation 140
	Rear view monitor system*		Cleaning 515
	Rear window defogger 351		Driver's seat position
	Rear window wiper 208		memory..... 68
	Replacing		Front seat adjustment 57
	Fuses 566		Head restraint 72
	Key battery 563		Properly sitting in the seat.... 111
	Light bulbs..... 582		Rear seat adjustment..... 59
	Tires 635		Seat heaters..... 489
	Reporting safety defects for		Service reminder
	U.S.A. owners 706		indicators 184
	Roll sensing of curtain shield		Shift lever
	airbags off switch 128		Automatic transmission..... 171
	Roof luggage carrier 301		If the shift lever cannot be
			shifted from "P" 651

Side airbags	113
Side marker lights	
Replacing light bulbs	582
Switch	196
Wattage	677
Side mirror	
Adjusting and folding	90
Mirror position memory.....	68
Smart key system	
Entry function	32
Starting the engine	166
“SOS” button	504
Spare tire	
Inflation pressure.....	553
Storage location	635
Spark plug	673
Specifications	668
Speedometer	179
Steering	
Column lock release.....	168
Fluid.....	539
Steering wheel	
Adjustment	86
Audio switches	398
Heated steering wheel.....	487
Steering wheel position memory	68
Stop lights	595
Storage feature	466
Storage precautions	301
Stuck	
If your vehicle becomes stuck.....	662
Sun visors	477
Sunshade	
Roof.....	98

Switch	
DISP switch	190
ECT switch	172
Driving mode select switch....	172
Emergency flasher switch	600
Engine switch	166
Fog light switch	201
Hazard light switch	600
Heated steering wheel switch	487
Ignition switch.....	166
Light switches.....	196
Power door lock switch	46
Power window switch	93
Rear window wiper and washer switch	208
VIEW switch	257
Window lock switch	93
Wipers and washer switch.....	202, 208

T	
Tachometer	
Tachometer	179
Tail lights	
Switch.....	196
Talk switch *	429
Telephone switch *	429
Theft deterrent system	
Alarm	107
Engine immobilizer system ...	105
Tire inflation pressure	553
Tie-down hooks	495
Tire information	
Glossary	687
Size	684
Tire identification number.....	683
Uniform tire quality grading ...	685

*: For vehicles with a navigation system, refer to the “Navigation System Owner’s Manual”.

Alphabetical index

Tires

Chains	309
Checking	544
If you have a flat tire	635
Inflation pressure	553
Information	682
Pressure warning system	544
Replacing	635
Rotating tires	544
Size	676
Snow tires	309
Spare tire	635
Tools	635
Total load capacity	308
Towing	
Dinghy towing	332
Emergency towing	601
Trailer towing	314
TRAC	281
Traction control	281
Trailer towing	314
Trip information display	190
Trip meter	179
Turn signal lights	
Replacing light bulbs	582
Switch	176
Wattage	677

V

Vanity lights

Vanity lights	478
Wattage	677
Vanity mirrors	478
Vehicle data recordings	24
Vehicle identification	
number	669
Vehicle stability control	281
Vehicle load limits	308
VIEW switch	257
Voice command switch*	429
VSC	281

W	Warning buzzers		Windshield wiper de-icer352
	Brake system.....	608	Windshield wipers202
	Open door	610	Wireless remote control key
	Seat belt reminder	611	Replacing the battery
	Warning lights		Wireless remote control key....44
	Anti-lock brake system	610	WMA disc373
	Brake system.....	608	
	Charging system	609	
	Low fuel level.....	612	
	Malfunction indicator lamp....	609	
	Master warning.....	612	
	Open door	610	
	Pre-collision.....	610	
	Seat belt reminder	611	
	Slip indicator light	610	
	SRS airbags	609	
	Tire pressure	611	
	Unengaged "Park"	611	
	Warning messages	619	
	Warning reflector holder	495	
	Washer		
	Checking	543	
	Preparing and checking		
	before winter	309	
	Switch.....	202, 208	
	Washing and waxing	512	
	Weight		
	Cargo capacity	301	
	Load limits	308	
	Weight	668	
	Wheels	557	
	Window glasses	93	
	Window lock switch	93	
	Windows		
	Power windows	93	
	Rear window defogger	351	
	Washer	202, 208	







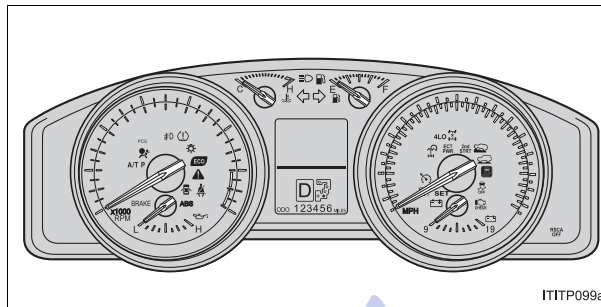







*: For vehicles with a navigation system, refer to the "Navigation System Owner's Manual".

What to do if...
What to do if...

A tire punctures	P. 635	If you have a flat tire
The engine does not start	P. 105	Engine immobilizer system
	P. 649	If the engine will not start
	P. 656	If the battery is discharged
The shift lever cannot be moved out	P. 651	If the shift lever cannot be shifted from "P"
The engine coolant temperature gauge enters the red zone	P. 659	If your vehicle overheats
Steam can be seen coming from under the hood		
The key is lost	P. 652	If you lose your keys
The battery runs out	P. 656	If the battery is discharged
The doors cannot be locked	P. 46	Side doors
	P. 51	Back door
The horn begins to sound	P. 107	Alarm
The vehicle is stuck in mud or sand	P. 662	If the vehicle becomes stuck
The warning light or indicator light comes on	P. 608	If the warning light turns on



■ Warning lights

	Brake system warning light P. 608		Driver's seat belt reminder light P. 611
	ABS warning light P. 610		Front passenger's seat belt reminder light
	SRS warning light P. 609	OR 	P. 611
	Open door warning light P. 610		Tire pressure warning light P. 611
	Charging system warning light P. 609		Pre-collision system warning light P. 610
	Unengaged "Park" warning light P. 611		Low fuel level warning light P. 612
	Malfunction indicator lamp P. 609		Master warning light P. 612
	Slip indicator light P. 610		

The warning message is displayed

P. 619 If a warning message is displayed

What to do if...

امداد خودرو فارما

تلفن شبانه روزی: ۰۲۱-۸۸۸۶۲۰۸۵

FarmaSOS.com

What to do if...

امداد خودرو فارما

تلفن شبانه روزی: ۰۲۱-۸۸۸۶۲۰۸۵

FarmaSOS.com

GAS STATION INFORMATION

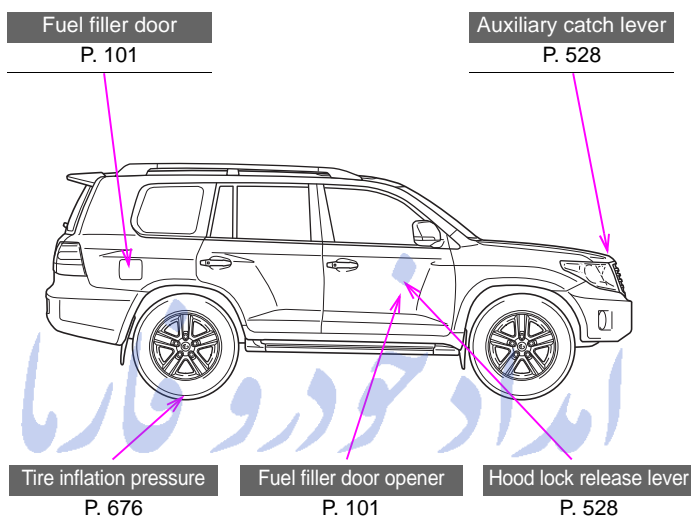

Fuel tank capacity (Reference)	24.5 gal. (93 L, 20.4 Imp.gal.)	
Fuel type	Unleaded gasoline only	P. 102, 670
Cold tire inflation pressure		P. 676
Engine oil capacity (Drain and refill — reference)	qt. (L, Imp.qt.) With filter 7.9 (7.5, 6.6) Without filter 7.5 (7.1, 6.2)	
Engine oil type		P. 671